

OLYMPUS®

CAMEDIA

DIGITAL CAMERA

C-8080 Wide Zoom

REFERENCE MANUAL

<Click Here>

CAMERA OPERATION MANUAL

Explanation of digital camera functions and operating instructions.

**DIGITAL CAMERA - PC CONNECTION
OPERATION MANUAL**

Explanation of how to download images between your digital camera and PC.

OLYMPUS®

CAMEDIA
DIGITAL CAMERA

C-8080 Wide Zoom

REFERENCE MANUAL

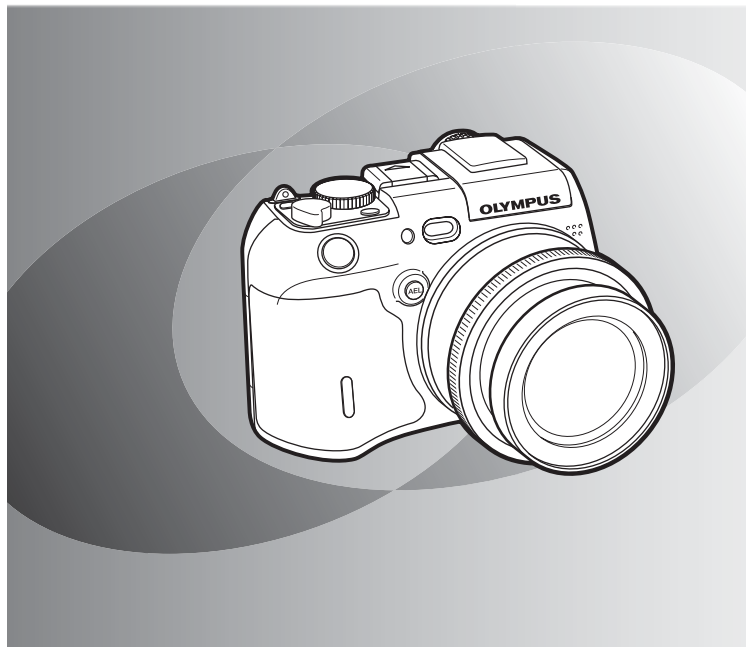

- Thank you for purchasing an Olympus digital camera. Before you start to use your new camera, please read these instructions carefully to enjoy optimum performance and a longer service life. Keep this manual in a safe place for future reference.
- We recommend that you take test shots to get accustomed to your camera before taking important photographs.
- Screen and camera illustrations shown in this manual were produced during the developmental stages and may differ from those of the actual product.

For customers in North and South America

For customers in USA

Declaration of Conformity

Model Number : C-8080 Wide Zoom
RM-2 (Remote control)

Trade Name : OLYMPUS

Responsible Party : Olympus America Inc.

Address : 2 Corporate Center Drive, Melville, New York
11747-3157 U.S.A.

Telephone Number : 1-631-844-5000

Tested To Comply With FCC Standards
FOR HOME OR OFFICE USE

This device complies with Part 15 of the FCC rules. Operation is subject to the following two conditions:

- (1) This device may not cause harmful interference.
- (2) This device must accept any interference received, including interference that may cause undesired operation.

For customers in Canada

This Class B digital apparatus meets all requirements of the Canadian Interference-Causing Equipment Regulations.

For customers in Europe



“CE” mark indicates that this product complies with the European requirements for safety, health, environment and customer protection. “CE” mark cameras are intended for sales in Europe.

Trademarks

- IBM is a registered trademark of International Business Machines Corporation.
- Microsoft and Windows are registered trademarks of Microsoft Corporation.
- Macintosh is a trademark of Apple Computer Inc.
- All other company and product names are registered trademarks and/or trademarks of their respective owners.
- The standards for camera file systems referred to in this manual are the “Design Rule for Camera File System/DCF” standards stipulated by the Japan Electronics and Information Technology Industries Association (JEITA).

Composition of the manual

	Contents	P.4	
	Names of parts	P.9	
Introduction of the camera's functions	Getting started	P.16	1
	Using the buttons and menus	P.29	2
Basic Photography	Shooting basics	P.46	3
Advanced Photography To get that particular shot using various effects or for fine-tuning the settings.	Flash	P.59	4
	Advanced shooting	P.70	5
	Adjusting the image quality and exposure	P.102	6
For playing back and editing pictures	Playback	P.121	7
Settings that make the camera easier to operate.	Customizing the camera	P.145	8
	Camera Settings	P.166	9
Printing pictures	Print setting (DPOF)	P.176	10
	Direct printing (PictBridge)	P.186	11
Troubleshooting and other information	Miscellaneous	P.200	
	Specifications	P.221	
	Glossary of terms	P.223	
	Index	P.226	

Contents

Composition of the manual	3
Names of parts	9
Camera	9
Viewfinder and monitor indications	11
Memory gauge	14
Battery check	14
How to use this manual	15

1 Getting started 16

Attaching the strap	16
Charging the battery	17
Loading the battery	18
Other ways to power the camera	19
Inserting a card	21
Card basics	21
Removing the card	22
Switching cards	23
Turning the power on/off	25
If the card is not recognized (card check)	26
Adjusting the viewfinder	27
Attaching the lens hood	27
Holding the camera	28
Changing the angle of the monitor	28

2 Using the buttons and menus 29



Direct buttons and menus	29
Direct buttons	31
Direct button basics	31
Functions that can be set using the direct buttons	33
Using the menus	37
Menu basics	38
Shortcut menus	40
Mode menus	42

3 Shooting basics 46













Shooting mode	46
Taking still pictures	50
If correct focus cannot be obtained	53
Determine the position of the subject after focusing (Focus Lock)	53
Subjects that are difficult to auto focus on	54
Recording movies 	55
Zoom	57



Using the optical zoom	57
Using the digital zoom	58

4 Flash 59









Flash shooting 	59
Using the slow synchronization flash  SLOW	63
Flash intensity control 	64
External flash (optional)	65
Using an Olympus external flash	65
Using a commercially available external flash	67
Compatible external flashes	68
Using the slave flash mode	69

5 Advanced shooting 70







Aperture priority shooting A	70
Shutter priority shooting S	71
Manual shooting M	72
Using My Mode 	73
Focusing applications	74
AF MODE - Changing the focus range	74
FULLTIME AF - A reliable time-saving way to focus	75
P-AF - Changing the auto focus mode	76
Changing the position of the AF target mark	77
AF illuminator	78
Manual focus	79
Metering 	81
Spot metering / Center-weighted metering	
- Selecting the metering area	81
Changing the position of the metering target mark	82
Multi-metering	
- Metering the exposure at more than one point  MULTI	83
AE Lock - Locking the exposure AEL	85
Macro mode shooting 	87
Super macro shooting 	88
Self-timer shooting 	89
Remote control shooting 	90
Changing the time until remote control is activated	91
Sequential shooting HI  AF  BKT	92
High speed, sequential and AF sequential	
shooting HI  AF 	92
Auto bracketing BKT	93
Panorama shooting	95
Guideline shooting 	97









Shooting in black & white or sepia-tone	98
FRAME ASSIST	
– Displaying vertical and horizontal lines to aid composition	99
Recording sound with still pictures 	100
Recording sound with movies 	101

6 Adjusting the image quality and exposure 102



Record mode 	102
RAW Data	103
3:2 Resolution	103
Selecting a record mode	105
ISO – Set-up appropriate sensitivity	107
Exposure compensation 	108
White balance WB	109
Auto white balance	109
Preset1 white balance	110
Preset2 white balance	110
Custom white balance	111
One-touch white balance 	111
White balance compensation WBZ	112
Saving a custom white balance	113
SHARPNESS 	114
CONTRAST 	115
HUE ^{RGB} 	116
SATURATION ^{RGB} 	117
SCENE MODES	117
NOISE REDUCTION NR	118
Histogram – Displaying the luminance distribution of still pictures 	119

7 Playback 121





Viewing still pictures 	121
QUICK VIEW	122
Picture rotation 	123
Close-up playback 	124
Index display 	125
Selecting the number of pictures	126
Slideshow 	127
Viewing movies 	128
Editing movies	130
Creating an index	131
Editing a movie	132
Playback on TV	134
INFO – Displaying shooting information INFO	135

Displaying guidelines 	136
Recording sound 	137
Editing still pictures	138
Resizing 	138
Trimming 	139
RAW editing	140
Copying pictures	141
Protecting pictures 	142
Erasing pictures 	143
Single-frame erase 	143
All-frame erase 	144





8 Customizing the camera 145

ALL RESET – Saving the camera's settings	145
REC VIEW – Checking the picture immediately after shooting	147
Setting the button operation sound BEEP	148
SHUTTER SOUND – Setting the shutter sound	149
DIAL – Changing the function of the control dial	150
EV STEP – Setting exposure adjustment increments	153
Custom button 	154
Setting the custom button	155
Using the custom button	156
SHORT CUT	157
Setting the shortcut menu	158
Using the shortcut menu	159
MY MODE SETUP – Setting a function in My Mode 	160
CONTROL PANEL – Using the monitor as a control panel	163
VOLUME – Adjusting the playback volume	165

9 Camera Settings 166

Formatting cards 	166
Selecting a language for on-screen display 	167
Setting the date and time 	168
Setting the warning tone 	169
SLEEP – Setting the time until the camera enters sleep mode	169
FILE NAME – Assigning a file name	170
BATTERY SAVE	
– Reducing battery consumption	171
PIXEL MAPPING – Checking the image processing functions	172
Adjusting the brightness of the monitor and viewfinder 	173
Measurement units m/ft	173
VIDEO OUT – Setting the video signal type	174
USB setup – Setting the connection destination	175

10 Print setting (DPOF) 176

How to print pictures 	176
All-frame reservation 	178
Single-frame reservation 	180
Trimming 	182
Resetting print reservation data 	184

11 Direct printing (PictBridge) 186

Using the direct printing function	186
Connecting the camera to a printer	187
Printing pictures	188
Easy printing	189
PRINT/MULTI PRINT	190
ALL PRINT	193
ALL INDEX mode/PRINT ORDER mode	195
Trim the picture	197
Exiting direct printing	198
If an error code is displayed	199

Miscellaneous 200

Error codes	200
Troubleshooting	201
List of menus	208
List of factory default settings	215
List of items by shooting mode	217
Camera maintenance	219
How to replace the battery (CR2025) of the remote control device	220
Specifications	221
Glossary of terms	223
Index	226

Names of parts

Camera

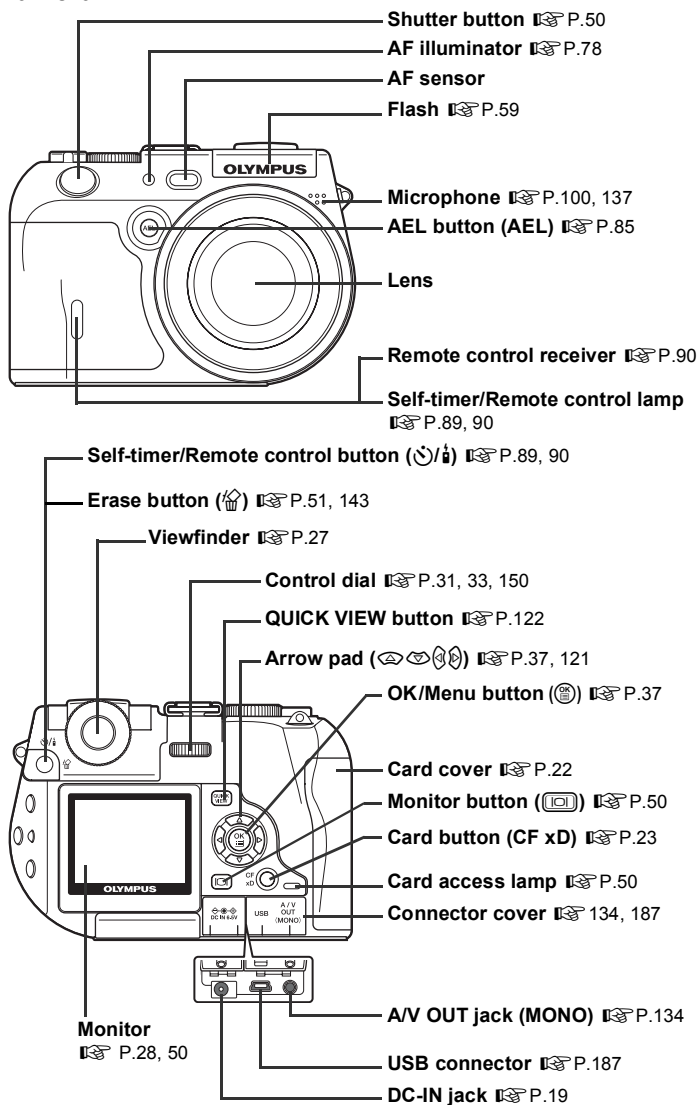

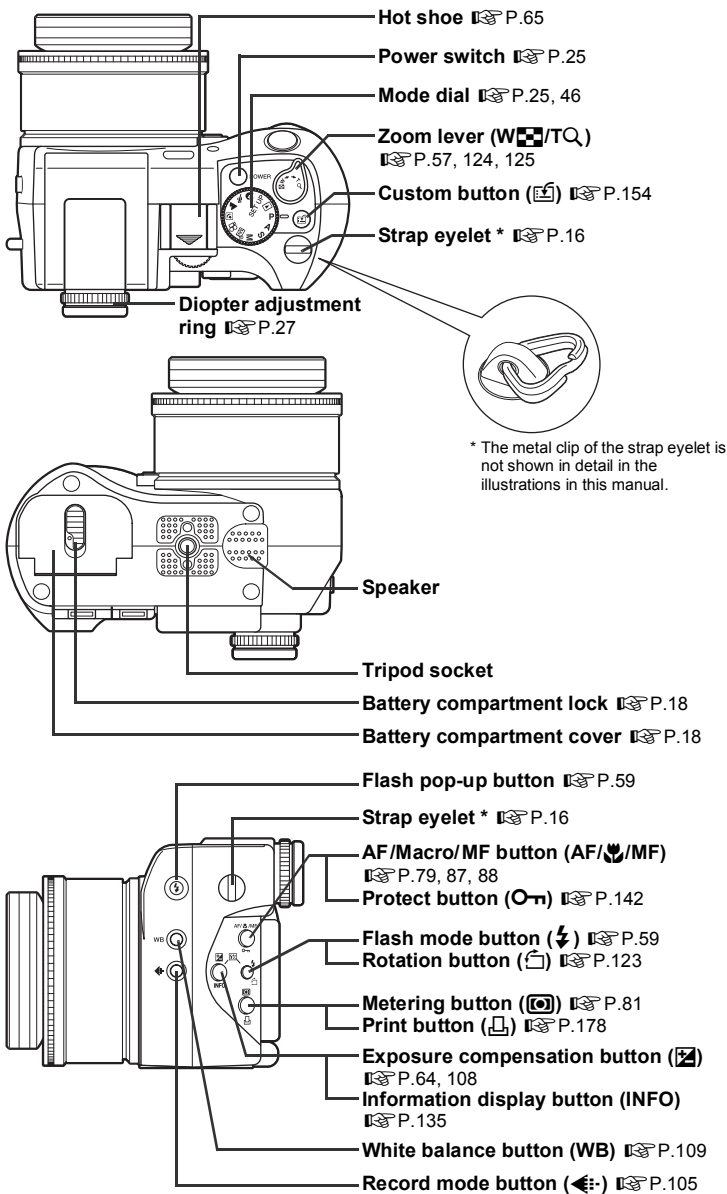

Viewfinder and monitor indications

● Shooting mode

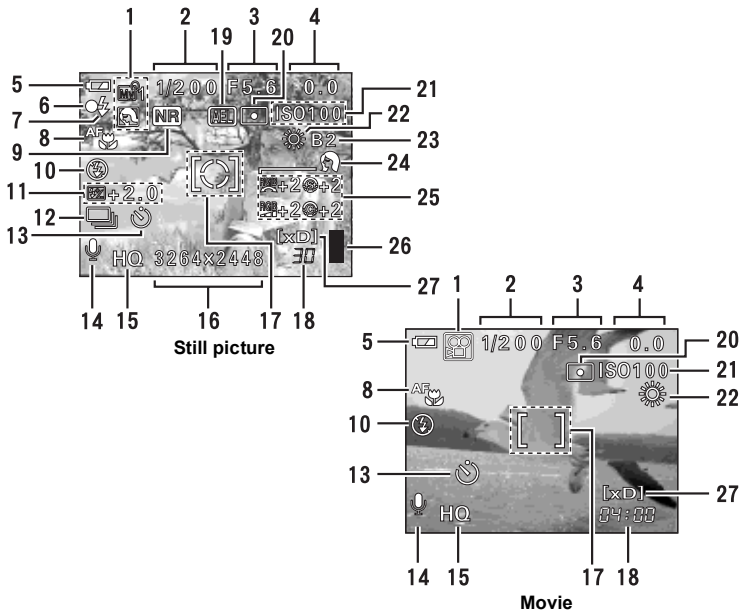

Item	Indication	Ref. page
1 Shooting mode	P, A, S, M,	P.46
2 Shutter speed	15" to 1/4000, BULB	P.71
3 Aperture value	F2.4 to F8.0	P.70
4 Exposure compensation Exposure differential	-2.0 to +2.0 -3.0 to +3.0	P.108 P.72
5 Battery check		P.14
6 Green lamp	○	P.50
7 Flash stand-by Camera movement warning/ Flash charge	Lights Blinks	P.50, 59
8 Macro mode Super macro mode Manual focus	AF AF MF, MF	P.87 P.88 P.79
9 Noise reduction	NR	P.118

	Item	Indication	Ref. page
10	Flash mode	SLOW1, SLOW2	P.59
11	Flash intensity control	-2.0 to +2.0	P.64
12	Sequential shooting mode	HI , AF , BKT	P.92
13	Self-timer Remote control		P.89 P.90
14	Sound record		P.100, 101, 137
15	Record mode	RAW, TIFF, SHQ, HQ, SQ1, SQ2	P.102
16	Resolution	3264 × 2448, 2048 × 1536, 640 × 480 etc.	P.104
17	AF target mark Metering target mark	[] 	P.50 P.81, 82
18	Number of storable still pictures Remaining recording time	30 04:00	P.104 P.55
19	AE lock AE memory	AEL MEMO	P.85
20	Metering mode		P.81
21	ISO	ISO50, ISO100, ISO200, ISO400 etc.	P.107
22	White balance	CWB1 to CWB4, CWB4, CWB4	P.109 P.111
23	White balance compensation	B1 to B7, R1 to R7	P.112
24	Scene modes		P.117
25	Hue	-5 to +5	P.116
	Saturation	-5 to +5	P.117
	Sharpness	-5 to +5	P.114
	Contrast	-5 to +5	P.115
26	Memory gauge		P.14
27	Card	[xD], [CF]	P.23

● Playback mode

INFO setting allows you to select how much information to display on the screen. Screens with the information display set to ON are shown below.

☞ “INFO – Displaying shooting information” (P.135)

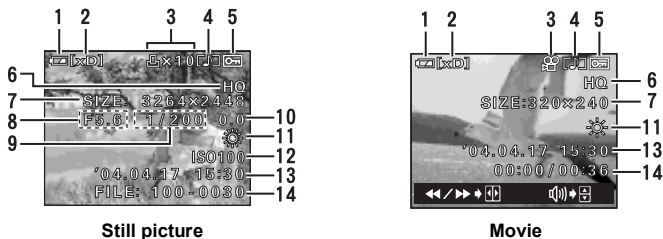

Still picture

Movie

	Item	Indication	Ref. page
1	Battery check		P.14
2	Card	[xD], [CF]	P.23
3	Print reservation/ number of prints Movie	x10 	P.178 P.128
4	Sound record	[J]	P.100, 101, 128
5	Protect	[On]	P.142
6	Record mode	RAW, TIFF, SHQ, HQ, SQ1, SQ2	P.102
7	Resolution	3264 × 2448, 2048 × 1536, 640 × 480, 320 × 240 etc.	P.104
8	Aperture value	F2.4 to F8.0	P.70
9	Shutter speed	8' to 1/4000	P.71
10	Exposure compensation	-2.0 to +2.0	P.108
11	White balance	WB AUTO,	P.109 P.111
12	ISO	ISO50, ISO100, ISO200, ISO400 etc.	P.107
13	Date and time	'04. 4.17 15:30	P.168
14	File number Playing time/Total recording time	FILE : 100 - 0030 00:00/00:36	P.170 P.128



Note

- The indications that appear on a movie picture that has been selected and displayed from the index display are different from those that appear when the movie picture is displayed using the movie playback function.

● Memory gauge

The memory gauge lights up when you take a still picture. While the gauge is lit, the camera is storing the picture on the card. The memory gauge indication changes as shown below depending on the shooting status. The indication is not displayed during movie recording.

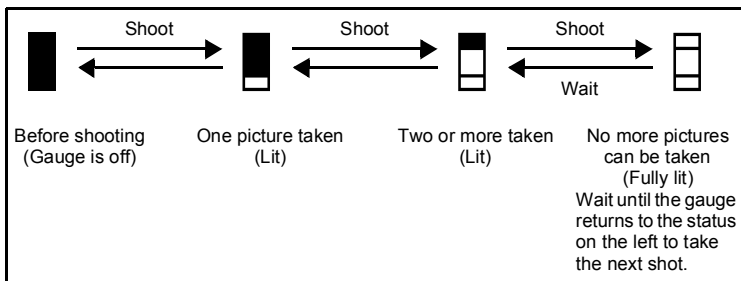
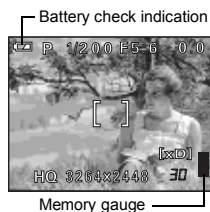

● Battery check

If the remaining battery power is low, the battery check indication changes as follows when the camera is turned on or while the camera is in use.

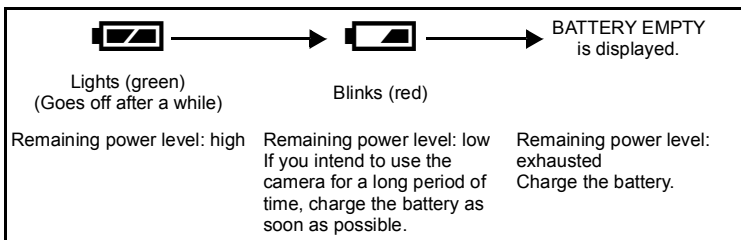

How to use this manual

Set the mode dial to any of the marks shown here.

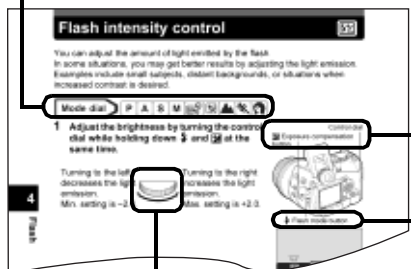

The buttons for the function and their location are clearly illustrated.

This shows control dial operations.

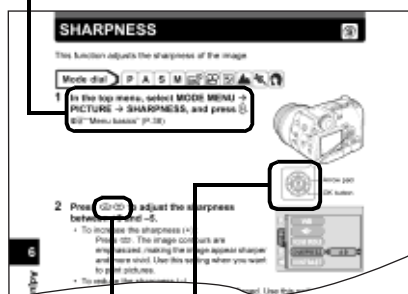

Follow the arrows to perform menu operations. For details on operating procedures, see "Menu basics" (P.38).



This represents the arrow pad. Only arrows applicable to the operation are shown.

This sample page is only for your reference. It may differ from the actual page in this manual.

● Indications used in this manual

 Note	Important information on factors which may lead to a malfunction or operational problems. Also warns of operations that should be absolutely avoided.
	Useful information and hints that will help you get the most out of your camera.
	Reference pages describing details or associated information.

1 Getting started

Attaching the strap

- 1 Pass the lens cap string through the hole in the lens cap, then pass the other end through the loop and pull tight.

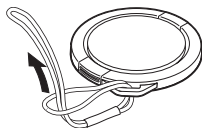

- 2 Pull the ends of the strap out of the stopper and ring.

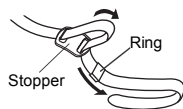

- 3 Thread the strap through the string loop (attached to the lens cap in Step 1).

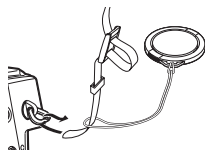

- 4 Thread the strap through the strap eyelet, then back through the ring and stopper as indicated by the arrows.

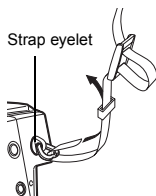

- 5 When you have decided how long you want the strap to be, pull on the strap in the stopper (A) to make sure it is securely fastened.

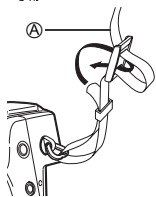

- 6 Attach the strap to the other eyelet following Steps 3 to 5.



Note

- Be careful with the strap when you carry the camera, as it can easily catch on stray objects, causing injury or damage.
- Attach the strap correctly as shown above so that the camera does not fall off. If the strap is attached incorrectly and the camera falls off, Olympus is not responsible for any damages.

Charging the battery

This camera uses one BLM-1 lithium ion battery. Other batteries cannot be used.

The battery is not fully charged at the time of purchase. Before using the camera, charge the battery using the BCM-2 charger. For more details, read the instructions provided with the charger.

1 Plug the power cord into the charger.

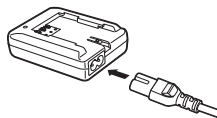

2 Plug the other end of the power cord into a household electrical outlet.

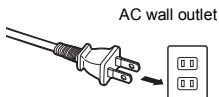

3 Remove the protection cap from the battery. Place the battery on the charger, making sure that it is correctly oriented as shown in the illustration.

- Align the battery with the guideline on the charger (⇔), and insert the battery into the charger as far as it goes.

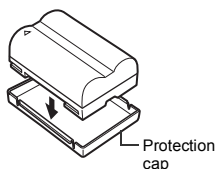

- Meaning of the charge lamp indications:
Lights red : Charging
Lights green : Charging is completed
Blinks red : Charging failure
- The battery charges in approximately 5 hours. The charging time may differ according to the amount of power left in the battery.

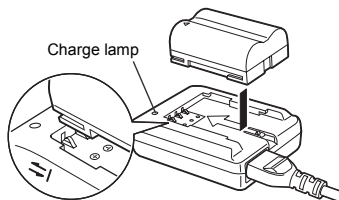

Note

- Use only the specified charger.
- The battery becomes warm during charging, but this is not a malfunction.
- If you intend to use the camera for a long period of time, you are recommended to carry a spare battery (sold separately) with you.
- Always secure the protection cap to the battery when carrying it or not being used to prevent short-circuiting of the battery terminals.

Loading the battery

This camera uses one BLM-1 lithium ion battery.

1 Make sure the camera is turned off.

- The monitor is off.
- The viewfinder is off.
- The lens is retracted.

2 Slide the battery compartment lock from to and open the battery compartment cover.

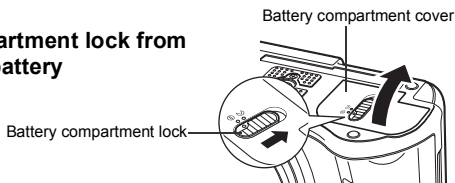

■ Inserting a battery

3 Insert the battery, making sure that it is correctly oriented as shown in the illustration.

- The battery lock secures the battery when correctly loaded.

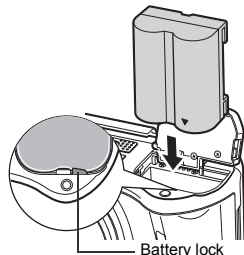

■ Removing the battery

Press the battery lock in the direction of the arrow ().

- The battery is ejected.
- Keeping your hand over the battery to stop it falling out, turn the camera right way up and remove the battery.

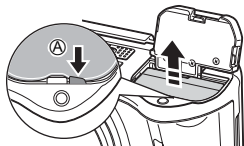

4 Close the battery compartment cover.

5 Slide the battery compartment lock from to .

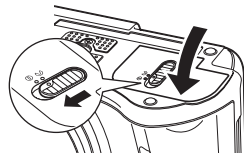

Battery level warning

The amount of power consumed varies considerably depending on the operations performed on the camera. If you use an exhausted battery, the camera may turn off without displaying the battery level warning (P.14).

Other ways to power the camera

● AC adapter

The optional Olympus CAMEDIA-brand AC adapter allows you to power your digital camera from a common AC wall outlet. Be sure to use the specified AC adapter. An AC adapter is useful for time-consuming tasks such as downloading images to a PC or outputting images on a printer.

Use an AC adapter designed to operate on the AC voltage in the area the camera is being used.

Consult your nearest Olympus dealer or Service center for details.

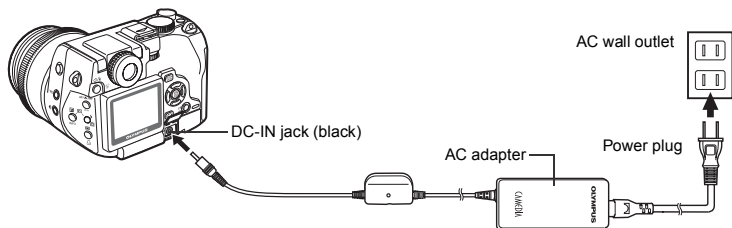

● Power battery holder

The optional power battery holder allows you to shoot for longer than when using the lithium ion battery. Be sure to remove the battery compartment cover pushing to the direction of the arrow when attaching the power battery holder to the camera.

For more details, read the instructions provided with the power battery holder.

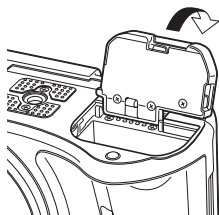

**TIPS****How to use the charger in another country**

→ To use the charger in another country, equip the charger with an adapter plug suited to the AC outlet in the intended region of use. Please ask your travel agency about which adapter plug to use.



Note

- If the battery power runs out while the camera is connected to a PC or printer, the image data may be lost or damaged. You are recommended to use the AC adapter when transferring images to a PC or printer. Do not connect or disconnect the AC adapter while the camera is communicating with the PC or printer.
- Do not remove or load the battery or connect or disconnect the AC adapter while the camera is turned on. Doing so could affect the camera's internal settings or functions.
- The battery consumption may vary according to the shooting conditions, etc.
- Power is consumed continuously during the conditions described below. This discourages the power to last longer.
 - When the monitor is turned on.
 - Repeated zoom adjustments.
 - Repeated auto-focus by depressing the shutter button halfway.
 - When the FULLTIME AF mode is turned on.
 - When the camera is connected to a PC or printer.
- When using an AC adapter, power is supplied to the camera by the AC adapter even if a battery is loaded in the camera. The AC adapter does not charge the battery in the camera.
- Carefully read the instructions for the AC adapter before use.

Inserting a card

"Card" in this manual refers to the xD-Picture Card, CompactFlash and Microdrive. The camera uses the card to record pictures.

The xD-Picture Card can be used simultaneously with CompactFlash or Microdrive.

Card basics

The card corresponds to normal camera film for recording the pictures you have taken. Pictures recorded and stored on the card can easily be erased, overwritten, and/or edited on a PC.

The following cards can be used. Read the instructions for the card carefully before use.

xD-Picture Card

- 16 MB to 512 MB



① Index area

You can write down the card's contents.

② Contact area

Comes into contact with the camera's signal read contacts.

CompactFlash (CF) (optional)

CompactFlash is a large-capacity solid state flash memory card. You can use commercially available cards.

- The camera may not function normally with some types of CompactFlash cards.

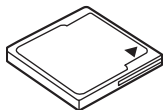

Microdrive (optional)

You can use Microdrive that supports CF+Type II (CompactFlash expansion standard). Microdrive is a compact hard disk drive. Be sure to read the "Precautions for using Microdrive" (P.24).



- 340 MB Microdrive cannot be used.
- This camera may not recognize a non-Olympus card or a card that was formatted on another device (such as a PC). Before use, be sure to format the card on this camera.  "Formatting cards" (P.166)

1 Make sure the camera is turned off.

- The monitor is off.
- The viewfinder is off.
- The lens is retracted.

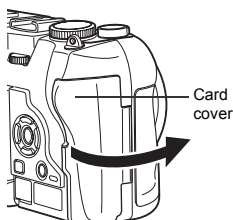
2 Open the card cover.**3 Insert a card.****xD-Picture Card**

- Insert the card into the front slot, ensuring that it is not inserted diagonally.
- Insert the card as far as it will go until it clicks.
- If the card is inserted incorrectly oriented or it is inserted at an angle, the contact area may be damaged or the card may become jammed.
- If the card is not inserted fully, it may not be able to record data.

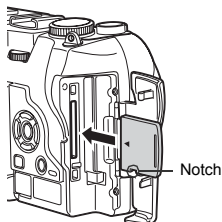
**CompactFlash/Microdrive**

- Hold the card straight and insert it correctly into the rear slot, as shown.
- Set the eject button in the down position.

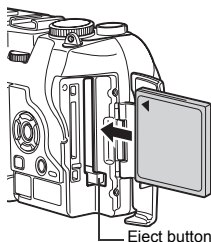
**4 Close the card cover securely until it clicks.****Removing the card****xD-Picture Card**

- Push the card all the way in to unlock it, then let it return slowly.
The card will be ejected. Take hold of the card and pull it out.

Note

Releasing your finger quickly after pushing the card all the way in may cause it to eject forcefully out of the slot.

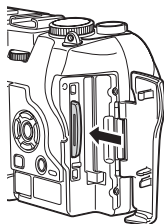

CompactFlash/Microdrive

- Set the eject button in the upright position.
- Press the eject button gently all the way in. The card will be ejected a short way.
- Take hold of the card and pull it out.
- Return the eject button to the down position before closing the card cover.

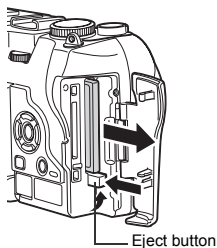

Note

- Do not push the card in with a pen or similar hard or pointed object.
- Never open the card cover, or remove the card or the battery while the camera is turned on. Doing so could destroy the data stored on the card. Once destroyed, data cannot be restored.

Switching cards

The card currently in use is indicated in the viewfinder or on the monitor. Choose the card you want to record the picture on before taking the picture.

The factory default setting is the xD-Picture Card. If only one card is inserted, that card is automatically selected. Card selection can also be made in Playback mode.

1 Press the card button repeatedly to select the card you want to use.

- The indication alternates between the two slots.

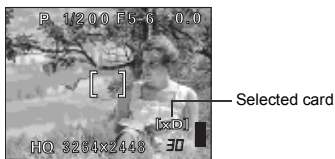

[xD] : xD-Picture Card

[CF] : CompactFlash or Microdrive

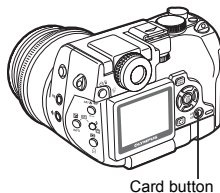

● **Precautions for using Microdrive**

The following restrictions apply when using Microdrive. Read the instructions provided with your Microdrive.

You are recommended to use an xD-Picture Card or CompactFlash card when taking important pictures.

Operating environment

Microdrive is a compact hard disk drive. As it is a rotating recording medium, it is not as resistant to vibration or impact as the solid recording medium of other cards.

When using Microdrive, be careful not to subject the camera to vibration or impact. (Special care is needed during recording and playback.)

- Do not bang the camera down on the table during recording.
- Be careful not to hit the camera against anything when carrying it on your shoulder.
- Do not use the camera where the ground is likely to vibrate, such as a construction site.
- Do not use the camera in the car while driving along a bumpy road etc., where the camera will be badly shaken.

Precautions regarding Microdrive

- Do not write on the label.
- Do not remove the label.
- Do not over-wrap labels.
- It is advisable to keep Microdrive in its case for storage or transportation.
- Microdrive may become hot if used for an extended period of time. Care should be taken when handling Microdrive.
- Do not take close to where there is strong magnetism.
- Do not apply strong pressure to the cover.

Camera operations

Using Microdrive may increase the battery consumption. To reduce consumption of the battery, observe the following.

- Whenever possible, refrain from using the monitor during shooting.
- Unless there is a particular need, remove the xD-Picture Card when using Microdrive.
- If nothing happens when the buttons are pressed, remove the battery, then put it back again.
- If you use Microdrive when the battery power is low, the camera may not turn on.

If CARD ERROR is displayed

- If no pictures can be recorded or downloaded, run SCANDISK on a PC.
 "Error codes" (P.200)

Turning the power on/off

- 1 Press the catch on the lens cap in the direction of the arrow and remove the lens cap.

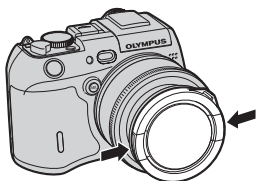

- 2 Turn the mode dial until the mode you want to use is aligned with the red line.

SET UP mode P.44

Use this mode to perform basic camera settings, such as date/time and beep sound. When the camera is turned on, the SET UP mode menu is displayed on the monitor.

Playback mode P.121

Use this mode to view pictures you have taken on the monitor.

Shooting mode P.46

Use one of these positions when you want to take pictures.

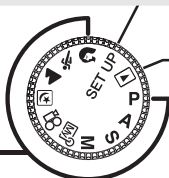

- 3 Press the power switch.

- The mode in which the camera turns on depends on the position of the mode dial.

Shooting mode:

The camera turns on in the shooting mode. The monitor turns on and the lens extends.

Playback mode:

The camera turns on in the playback mode and the monitor turns on.

SET UP mode:

The menu is displayed on the monitor.

- You can change the mode with the camera turned on, or off.

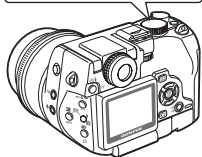
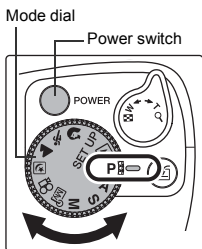

- 4 Press the power switch again to turn the camera off.



TIPS

Setting the date and time

Pictures are saved with the date and time when they were taken.

 "Setting the date and time" (P.168)

Selecting a language for on-screen display

You can select the language in which illustrations and explanations are displayed on the monitor.

 "Selecting a language for on-screen display" (P.167)

The viewfinder or monitor turned off

- To reduce battery consumption, the lens retracts to the widest position and the camera automatically enters the sleep mode after about 3 minutes of non-operation. The camera activates again as soon as you touch the shutter button or zoom lever. You can select the length of time until the camera enters the sleep mode.

 "SLEEP – Setting the time until the camera enters sleep mode" (P.169)

- To reduce battery consumption, the camera turns off automatically and the lens retracts after about 4 hours of non-operation. To resume operation, turn the camera on again.









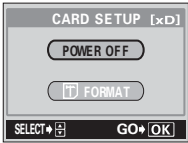

Note

- If the camera is subjected to strong vibration or impact while it is turned on, it may turn off momentarily and the date and other settings return to the factory default settings.

If the card is not recognized (card check)

When the power is turned on, the camera checks the card automatically. If there is no card in the camera or a card that is not supported by this camera is inserted, the following screen is displayed.

Monitor indication	Corrective action
 NO CARD	There is no card in the camera or the card is not inserted properly. → Insert a card. If a card is already inserted, remove it and insert it again.
	The card cannot record, play back or erase pictures. Replace the card with a new one or format the card. → Press   to select POWER OFF, then press  . Replace the card with a new one. → Format the card. Press   to select  FORMAT, then press  to display the confirmation screen. Select YES and press  . Formatting starts. If the card was successfully formatted, the camera is ready to take pictures.



Note

- All data stored on the card is erased when the card is formatted.

Adjusting the viewfinder

You can adjust the viewfinder to match your eyesight (visual acuity).

- 1 With the viewfinder off, press  to turn it on.

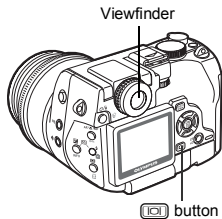

- 2 Look through the viewfinder and slowly turn the diopter adjustment ring.

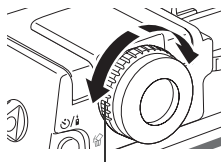

- 3 Turn the diopter adjustment ring until the AF target mark can be seen clearly.



AF target mark

Attaching the lens hood

When light shines directly on the lens, flare or ghosting may occur. To prevent this happening, attach a lens hood.

- 1 Fit the lens hood matching the lens hood indicator () with the indicator on the lens.
- 2 Turn the lens hood in the direction of the arrow as far as it goes.

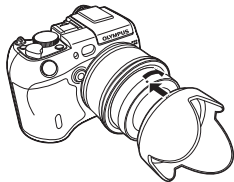

Note

- The lens hood cannot be attached or detached when the lens cap is on.
- The lens cannot be retracted with the lens hood attached backwards.

Holding the camera

Hold the camera firmly with both hands while keeping your elbows at your sides to prevent the camera from moving. When taking pictures in the vertical position, hold the camera in a position as shown in the illustration. Keep your fingers, the strap and the lens cap away from the lens, flash and AF sensor.

Horizontal grip



Vertical grip



Top view

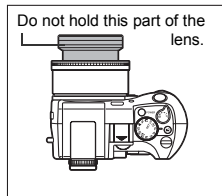

Note

- Clear pictures cannot be obtained if the camera moves as the shutter button is pressed. Hold the camera correctly, and press the shutter button gently.
- For the best results, hold camera at right position so that flash is positioned higher than the lens.

Changing the angle of the monitor

You can change the angle of the monitor. This is useful for taking low-angle shots where the viewfinder or monitor is hard to see.

- 1 Take hold of the monitor as shown in the illustration and pull it out.**

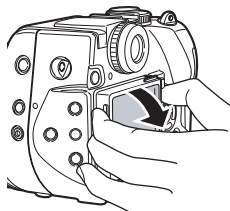

- 2 To take low-angle shots, position the monitor in the up position as shown.**

- The monitor can be positioned in the down position at an angle of 45 degrees and in the up position at an angle of 22, 45 or 90 degrees.
- To take high-angle shots, position the monitor in the down position.

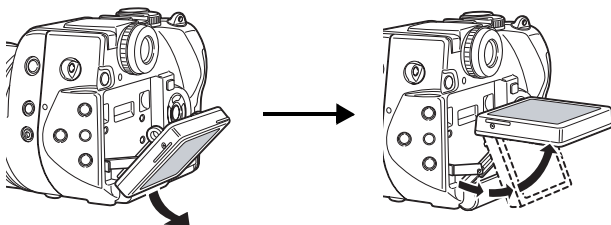

2 Using the buttons and menus

Direct buttons and menus

This camera is equipped with direct buttons for quick operation and setting of various shooting and playback-related functions. The setting screens are displayed on the monitor when the direct buttons are pressed. Menus are also provided for selecting the various shooting and playback settings.

Functions that can be set using the direct buttons can also be set using the menus.

Ex 1: To select a metering mode

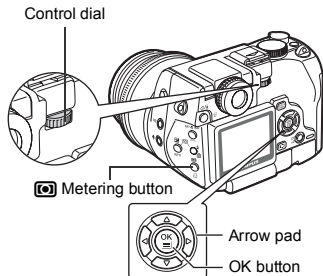

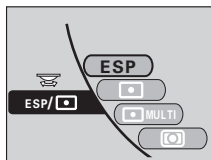

Using the direct button

Press .



- The setting screen is displayed on the monitor.
- Turn the control dial while holding down  to select a metering mode.

Using the menus

Press  to display the menu, then select MODE MENU – CAMERA tab – ESP/.

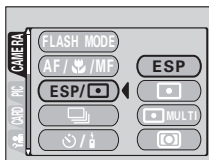

- Press   to select a metering mode.

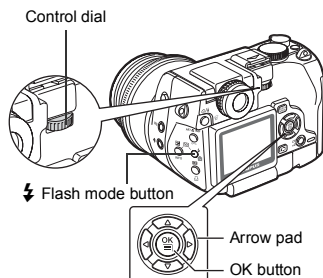
Ex 2: To select a flash mode**Using the direct button**

Press .

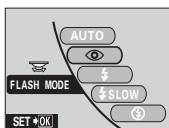

- The setting screen is displayed on the monitor.
- Turn the control dial while holding down  to select a flash mode.

Using the menus

Press  to display the menu, then select MODE MENU – CAMERA tab – FLASH MODE.

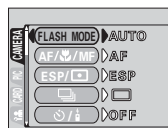

- Use the arrow pad to select flash-related settings.

Press 

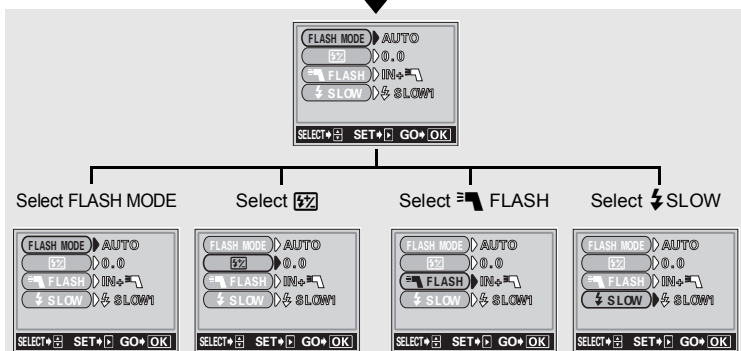

The same setting screen is displayed using the direct button or the MODE MENU.

**TIPS**

Flash intensity control can be adjusted directly by turning the control dial while holding down .

Direct buttons

The direct buttons have different functions in the shooting mode and in the playback mode. Turning the control dial while holding down the direct button allows you to select menu options or change the values for the different functions.

Certain function settings require the direct button to be pressed repeatedly.

Direct button basics

The procedure for making settings using the direct buttons and control dial is shown below. The setting screens are displayed on the monitor when pressing the direct button.

Ex: Using the ⚡ (flash mode) button

1 Turn the control dial while holding down ⚡ to select the flash mode.

- The setting screen is displayed on the monitor.
- At the moment you release your finger from the ⚡ button, the flash mode setting is made.
- If the operation guide is displayed at the bottom of the screen, you can select further options.

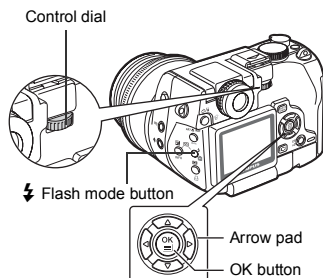

2 Press while holding down ⚡ to display the menu.

Release the direct button after the menu is displayed.

- The menu for changing the current settings for the various flash options is displayed.

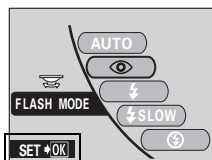

Operation guide

3 Follow the operation guide to select the item and option you want to change.

 For further details, see "Menu basics" (P.38).

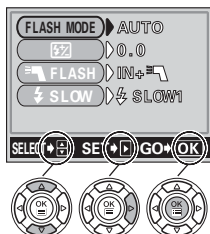

The icons displayed in the operation guide correspond to the arrow pad and  button.

**TIPS**

Further options may be available depending on the option you selected. If the operation guide is displayed at the bottom of the screen, you can select further options.

Ex)**When the (self-timer/remote control) button is used**

Turn the control dial while holding down to change the setting.



If you select , the operation guide is displayed.

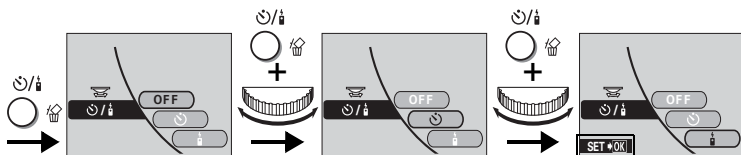

Operation guide
Pressing while holding down displays the screen for selecting the time that remote control is activated.

Functions that can be set using the direct buttons

● Shooting mode

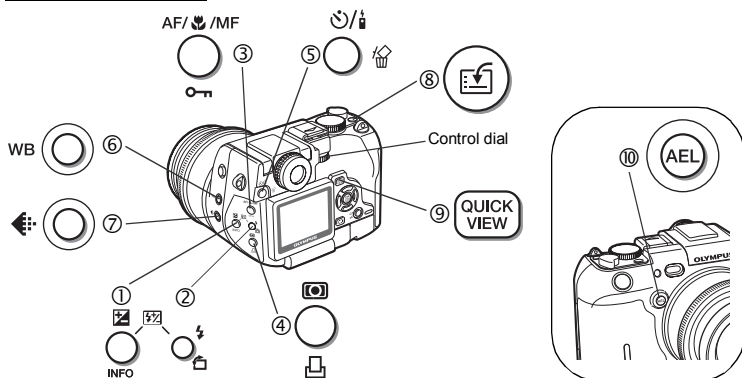



This means to turn the control dial while holding down the direct button to make function settings.

① (exposure compensation) button

 P.108

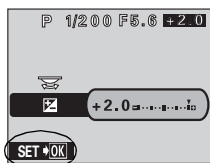
Changes the exposure compensation value.







The histogram display can be set.
 P.119

② (flash mode) button

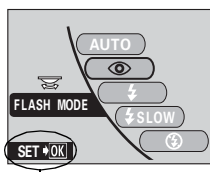
 P.59

Selects a flash mode from auto,  (red-eye reduction),  (fill-in flash),  SLOW (slow synchronization) and  (flash off).



You can select the various options available in FLASH MODE,  (flash intensity control),  FLASH (external flash) and  SLOW (slow synchronization) mode.
 P.63

①+②
Press at the same time

 (flash intensity control) buttons

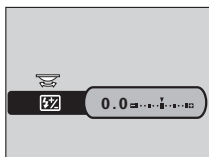

 P.64

Adjusts the amount of light emitted by the flash.





③ **AF/MF** (AF/Macro/MF) button

 P.79, 87, 88

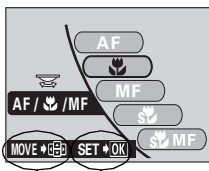
Selects a focus mode from AF (auto-focus),  (macro), MF (manual focus),  (super macro) and  MF (super macro MF).





You can select the various options available in FOCUS MODE, AF MODE, FULLTIME AF and P-AF mode.  P.74, 75, 76



When the AF MODE is set to SPOT, the AF target mark can be moved.  P.77

④  (metering) button

 P.81, 83

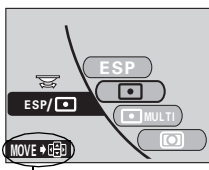
Selects a metering mode from ESP, spot metering () , multi-metering ( MULTI) and center-weighted metering ().





When the metering mode is set to , the metering target can be moved.  P.82

⑤  (self-timer/remote control) button

 P.89, 90

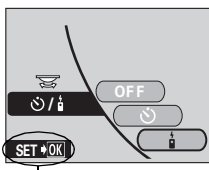
Activates the self-timer or remote control function.



When  is selected, you can set the time that remote control is activated.  P.91

⑥ **WB** (white balance) button

P.109

Selects a white balance setting from AUTO, PRESET 1, PRESET 2, CUSTOM and  (one-touch).

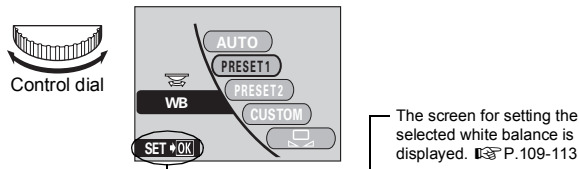

⑦  (record mode) button

P.105

Sets the image quality and resolution.

Still pictures : RAW, TIFF, SHQ, HQ, SQ1, SQ2

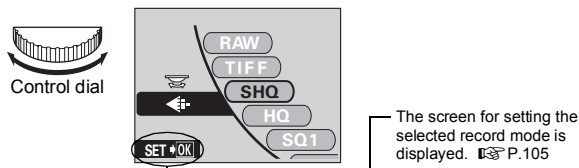
Movies : SHQ, HQ, SQ

⑧  (custom) button

P.154

Activates the function registered on the custom button.

See "Custom button" (P.154) for details of how to register a function and use the button.

⑨ **QUICK VIEW** button

P.122

Displays the last picture taken on the monitor.







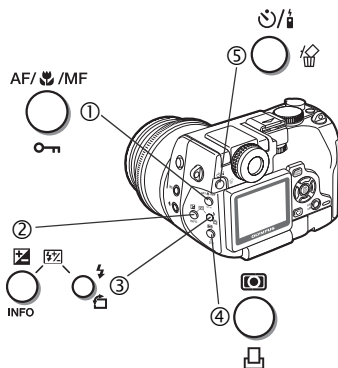

⑩ **AEL** (AE Lock) button

P.85

Fixes the exposure. The lock function is alternately activated and canceled each time you press the button.

● Playback mode



- | | | |
|---|---|--|
| ① |  (protect) button |  P.142 |
| | Protects important pictures from accidental erasure. | |
| ② | INFO (information display) button |  P.135 |
| | Displays the shooting information and histogram. | |
| ③ |  (rotation) button |  P.123 |
| | Rotates pictures 90 degrees clockwise or counterclockwise. | |
| ④ |  (print) button |  P.178 |
| | Stores print reservation data on the card. | |
| ⑤ |  (erase) button |  P.143, 144 |
| | Erases a selected picture. | |

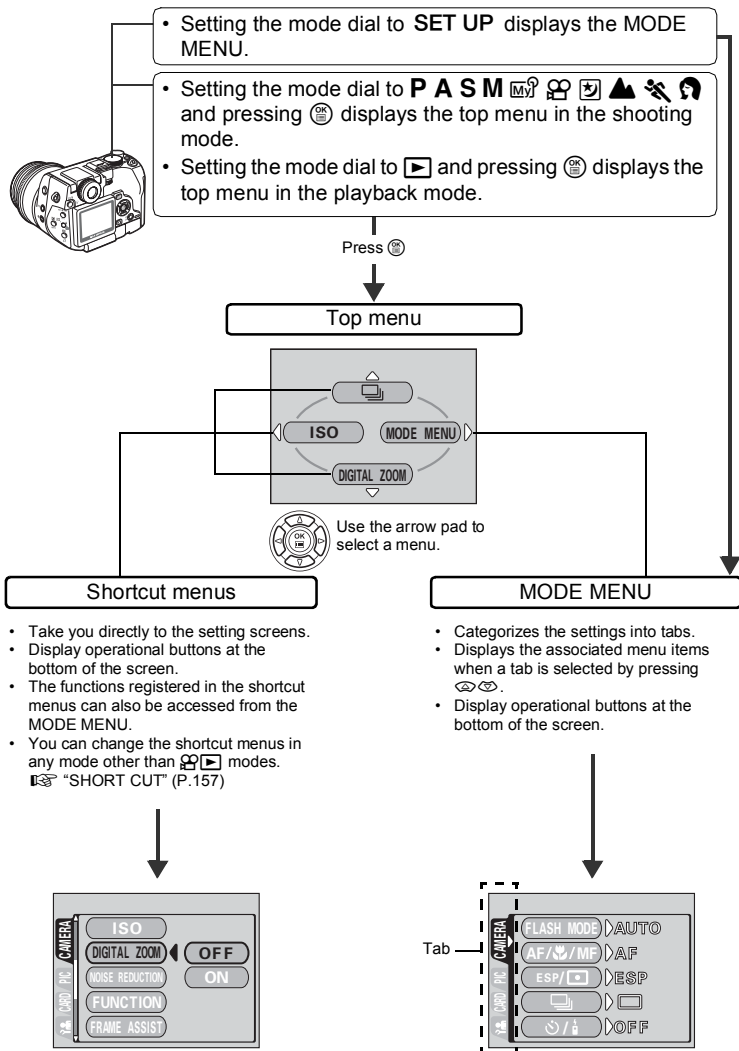

Using the menus

There are two types of menu: the top menu which is the first screen that appears on the monitor when you turn on the camera and press , and the MODE MENU which categorizes settings into tabs. The functions of this camera are set from the menus. When the mode dial is set to **SET UP**, the MODE MENU is displayed instead of the top menu.



Menu basics

This section explains how the menus work, using the **P** mode screens. Setting the mode dial to **SET UP** displays the screen in Step 2.

1 Press  to display the top menu, then press .

2 Press   to select a tab, then press .

2

Using the buttons and menus

Top menu

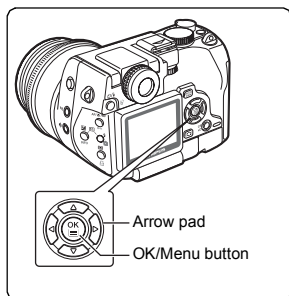
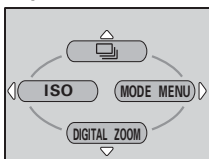

CAMERA tab

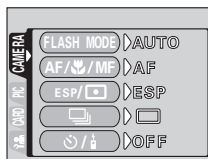

PICTURE tab

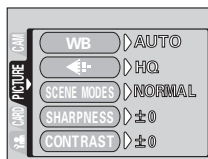

CARD tab

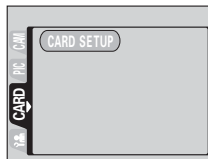

PERSONALIZATION tab

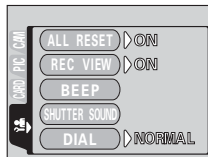

Press  to return to the tab selection screen.

- 3 Press to select the item you want to set, then press .

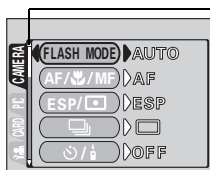

Slider bar
Displayed when there are more items on the next page.

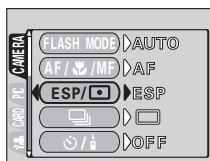
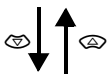

The green frame moves to the selected item.

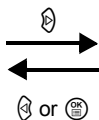

To return to select an item, press or .

- 4 Press to select a setting. Press to complete setting. Press again to exit the menu.

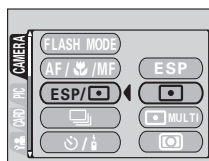
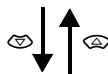
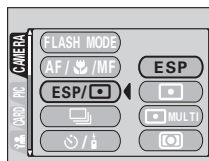

While **SET UP** is selected on the mode dial, turn the dial other than **SET UP** to exit the MODE MENU.



Note

- Not all items can be selected depending on the status of the camera and the settings performed.
- You can take pictures by pressing the shutter button in the shooting mode with the menu open.
- If you want to save the settings even if the camera turns off, set ALL RESET to OFF. "ALL RESET – Saving the camera's settings" (P.145)

Shortcut menu

● Shooting mode

P A S M  mode
 mode
 (for still pictures)

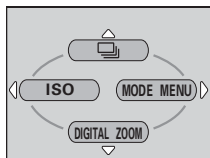

(Factory default setting)



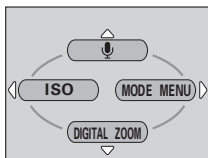

 mode
 (for movies)



2

Using the buttons and menus



Selects a shooting mode from  (single-frame shooting), **HI**  (high speed sequential shooting),  (sequential shooting), **AF**  (AF sequential shooting) and **BKT** (auto bracketing).

P.92

 (movies)

Selects whether to record sound when shooting a movie.

P.101

ISO

Selects the ISO value from AUTO or in the range of ISO 50 to ISO 400.

P.107



DIGITAL ZOOM

Digitally enhances the maximum optical zoom.

P.58



TIPS

The functions registered in the shortcut menu can also be accessed from the MODE MENU. You can change the shortcut menu in any mode except  and  modes.  "SHORT CUT" (P.157)

● Playback mode (▶)

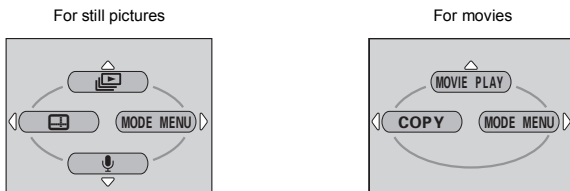

Runs through all saved pictures one after another.

P.127

MOVIE PLAY

MOVIE PLAYBACK	Plays back movies.	P.128
INDEX	Creates an indexed view of a movie in 9 frames.	P.131
EDIT	Edits a movie.	P.132



Displays guidelines on the image.

P.136

COPY

Copies pictures to and from cards. Lets you select whether to copy all frames or only a selected frame.		P.141
---	--	-------



Adds sound to a still picture already taken.

P.137

Mode menus

The MODE MENU functions are divided into tabs. Press to select a tab and display the associated menu items.

TABS

CAMERA tab: regards picture taking.

PICTURE tab: regards picture appearance.

EDIT tab : regards editing picture already taken.

CARD tab : regards memory card formatting, etc.



tab : regards customizing functions.

SETUP tab : regards basic settings of the camera.

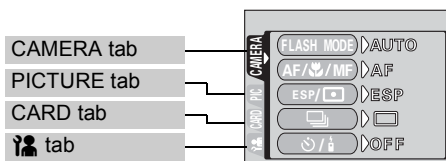

● Shooting mode (P A S M mode)



CAMERA tab		
FLASH MODE	Selects flash-related settings. Sets the options available in flash mode, flash intensity control, external flash and slow synchronization.	P.59
AF//MF	Selects the options available in focus mode, AF mode, fulltime AF and P-AF.	P.74, 75, 76
ESP/	Selects a metering mode from ESP, spot metering, multi-metering and center-weighted metering.	P.81
	Selects a shooting mode from (single-frame shooting), HI (high speed sequential shooting), (sequential shooting), AF (AF sequential shooting) and BKT (auto bracketing).	P.92
	Selects the self-timer or remote control function.	P.89, 90
ISO	Selects the ISO value from AUTO or in the range of ISO 50 to ISO 400.	P.107
DIGITAL ZOOM	Digitally enhances the maximum optical zoom.	P.58
NOISE REDUCTION	Reduces the noise that affects pictures during long exposures.	P.118
FUNCTION	Enables panorama and guideline shooting, and lets you take pictures in black & white or sepia tone.	P.95, 97, 98
FRAME ASSIST	Displays lines as a guide for composing the picture.	P.99
	This function lets you record sound when taking a still picture.	P.100
MY MODE	Selects a mode to be activated when taking pictures in mode.	P.73
	Displays a histogram showing the luminance distribution of still pictures.	P.119

PICTURE tab		
WB	Sets the appropriate white balance according to the light source. Also adjusts and saves the white balance.	P.109
	Sets the image quality and resolution. Still pictures : RAW, TIFF, SHQ, HQ, SQ1, SQ2 Movies : SHQ, HQ, SQ	P.102
SCENE MODES	Lets you take pictures suited to the situation and the desired effect ().	P.117
SHARPNESS	Adjusts the sharpness of the image.	P.114
CONTRAST	Adjusts the contrast of the image.	P.115
HUE	Adjusts the overall tint of the picture.	P.116
SATURATION	Adjusts the level of color depth without changing the tint.	P.117

CARD tab		
CARD SETUP	Formats a card.	P.166

 tab		
ALL RESET	Selects whether to keep the current camera settings when you turn off the power.	P.145
REC VIEW	Displays the picture on the monitor while recording it to a card.	P.147
BEEP	Sets the beep sound used for button operations and adjusts the volume.	P.148
SHUTTER SOUND	Sets the sound made when the shutter button is pressed and adjusts the volume.	P.149
DIAL	Changes the control dial, arrow pad and direct button functions.	P.150
EV STEP	Selects whether to set the shutter speed, aperture value and exposure compensation, etc. in 1/3EV steps or in 1/2EV steps.	P.153
CUSTOM BUTTON	Lets you assign a frequently used function to the camera's custom button.	P.154
SHORT CUT	Lets you assign frequently used functions as shortcut menus.	P.157
MY MODE SETUP	Customizes settings which are activated in the  mode.	P.160
CONTROL PANEL	Displays the settings in the shooting mode on the monitor.	P.163

● Playback mode (▶)

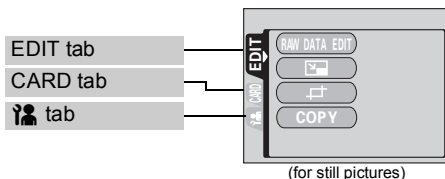

EDIT tab*		
RAW DATA EDIT	Sets the image quality, white balance, etc. of pictures taken in RAW data format and saves them as new files.	P.140
	Makes the file size smaller and saves it as a new file.	P.138
	Crops part of a picture and saves it as a new file.	P.139
COPY	Copies pictures to and from cards. Lets you select whether to copy all frames or only a selected frame.	P.141

* The EDIT tab is not displayed during movie playback.

CARD tab		
CARD SETUP	Erases all image data stored on the card or formats a card.	P.144, 166



PERSON tab		
ALL RESET	Selects whether to keep the current camera settings when you turn off the power.	P.145
BEEP	Sets the beep sound used for button operations and adjusts the volume.	P.148
VOLUME	Adjusts the sound volume during playback.	P.165
	Selects the number of frames in the index display.	P.126

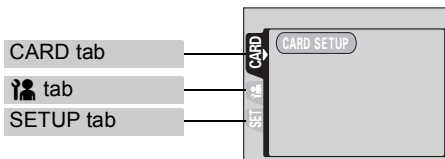



● SET UP mode



The functions assigned to the PERSON tab in both shooting and playback modes can also be set from the PERSON tab in SET UP mode.

CARD tab		
CARD SETUP	Formats a card.	P.166

i tab		
ALL RESET	Selects whether to keep the current camera settings when you turn off the power.	P.145
REC VIEW	Displays the picture on the monitor while recording it to a card.	P.147
BEEP	Sets the beep sound used for button operations and adjusts the volume.	P.148
SHUTTER SOUND	Sets the sound made when the shutter button is pressed and adjusts the volume.	P.149
DIAL	Changes the control dial, arrow pad and direct button functions.	P.150
EV STEP	Selects whether to set the shutter speed, aperture value and exposure compensation in 1/3EV steps or in 1/2EV steps.	P.153
CUSTOM BUTTON	Lets you assign a frequently used function to the camera's custom button.	P.154
SHORT CUT	Lets you assign frequently used functions as shortcut menus.	P.157
MY MODE SETUP	Customizes settings which are activated in the  mode.	P.160
CONTROL PANEL	Displays the settings in the shooting mode on the monitor.	P.163
VOLUME	Adjusts the sound volume during playback.	P.165
	Selects the number of frames in the index display.	P.126

SETUP tab		
	Selects a language for on-screen display.	P.167
	Sets the date and time.	P.168
	Sets the beep sound used for warnings and adjusts the volume.	P.169
SLEEP	Sets the time from the moment the camera was last operated until it enters sleep mode.	P.169
FILE NAME	Changes how file names are assigned.	P.170
BATTERY SAVE	Turns the powersaving mode on and off.	P.171
PIXEL MAPPING	Checks the CCD and image processing functions for errors.	P.172
	Adjusts the brightness of the viewfinder or monitor.	P.173
m/ft	Sets the measurement unit (m/ft) used during manual focus.	P.173
VIDEO OUT	Selects NTSC or PAL according to your TV's video signal type. TV video signal types differ depending on the region.	P.174
AF ILLUMINATOR	Turns on the AF illuminator to illuminate a dark subject.	P.78
USB	Sets whether the camera is connected to a PC or a printer with the USB cable.	P.175

3 Shooting basics

Shooting mode

The shooting mode includes modes where the optimal settings for the situation are automatically selected, and modes where you can select the settings best suited to the shooting conditions and the effect you wish to achieve. You can change the mode with the camera turned on, or off.

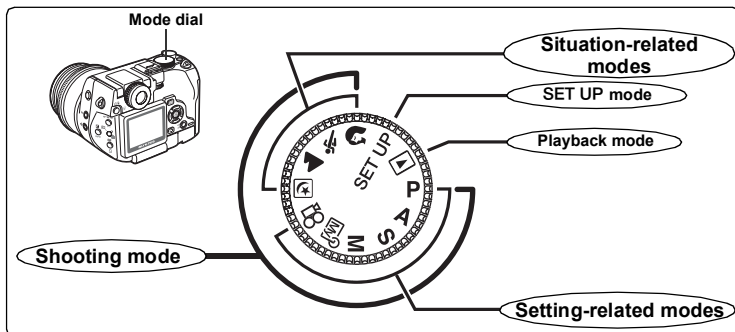

Setting-related modes

P Program shooting

The camera automatically sets the optimum aperture value and shutter speed for the brightness of the subject. Other functions, such as flash mode and record mode, can be adjusted manually.

Program shift

Program shift allows you to change the combination of aperture value and shutter speed set by the camera without altering the exposure.

- Press to change the aperture value and the shutter speed that determines an appropriate exposure.
- **Ps** is displayed on the monitor in the program shift mode.
- The brightness of the subject or certain flash settings may prevent the program shift.
- To cancel the program shift mode, do one of the following:
 - If the combination of shutter speed and aperture value was changed by pressing , press until **Ps** goes out.
 - If the combination of shutter speed and aperture value was changed by pressing , press until **Ps** goes out.
 - Change the mode to **A**, **S**, **M**, or .

A Aperture priority shooting

Allows you to set the aperture manually. The camera sets the shutter speed automatically. By decreasing the aperture value (F number), the camera will focus within a smaller range, producing a picture with a blurred background. Increasing the value forces the camera to focus over a wider range in the forward and backward directions, resulting in a picture in which both the subject and the background are in focus.

☞ “Aperture priority shooting” (P.70)

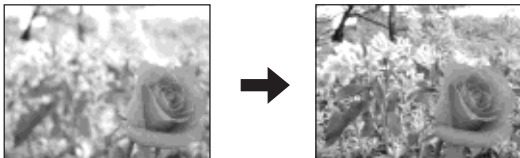

Aperture (F number) is decreased. Aperture (F number) is increased.

S Shutter priority shooting

Allows you to set the shutter speed manually. The camera sets the aperture automatically. Set the shutter speed according to the subject and the type of effect you want.

☞ “Shutter priority shooting” (P.71)



Setting the shutter speed higher lets you capture fast-moving action without blur. The subject will be clear and sharp, as if it were not moving.



Setting the shutter speed lower blurs a moving subject, giving the impression of movement.

M Manual shooting

Allows you to set the aperture and shutter speed manually. To check the exposure, refer to the exposure differential displayed on the monitor. This mode gives you more creative control, allowing you to make the settings you need to get the type of picture you want, regardless of optimum exposure. Using bulb allows you to take pictures at the max of 8 min of long exposure.

👉 “Manual shooting” (P.72)

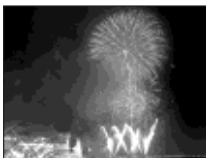

My Mode

Allows you to save your favorite settings as your own personal mode and use these customized settings when taking pictures. Current settings can also be saved for retrieving by this mode. 👉 “MY MODE SETUP – Setting a function in My Mode” (P.160) 👉 “Using My Mode” (P.73)

Movie record

This function allows you to record movies. The camera automatically determines the aperture and shutter speed. Sound is recorded at the same time. The focus and zoom are locked. If the distance to the subject changes, focus may be compromised.

👉 “Recording movies” (P.55)

Situation-related modes

Night Scene shooting

Suitable for shooting pictures in the evening or at night. The camera sets a slower shutter speed than is used in normal shooting. For example, if you take a picture of a street at night in **P** mode, the lack of brightness will result in a dark picture with only dots of light. In the Night Scene shooting mode, the true appearance of the street is captured. The camera automatically selects the optimal settings for this type of shooting condition. Since the shutter speed is slow, make sure you stabilize the camera by using a tripod.

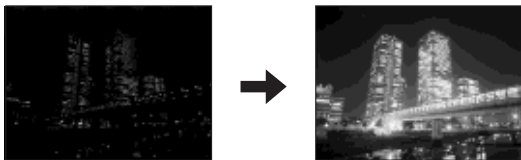

Landscape shooting

Suitable for taking pictures of landscapes and other outdoor scenes. Both the foreground and the background are in focus. Since blues and greens are vividly reproduced in this mode, it is excellent for shooting natural scenery. The camera automatically sets the optimal shooting conditions.

Sports shooting

Suitable for capturing fast-moving action (such as sports) without blur. Even a fast-moving subject will be clear and sharp as if it were not moving. It enables you to capture facial expressions and detailed activity. The camera automatically sets the optimal shooting conditions.

Portrait shooting

Suitable for taking a portrait-style shot of a person. This mode features an in-focus subject against a blurred background. The camera automatically sets the optimal shooting conditions.



Note

- The available settings vary depending on the mode.  "List of items by shooting mode" (P.217)

Taking still pictures

You can take still pictures using either the viewfinder or the monitor.

Mode dial



- 1 Set the mode dial to **P A S M** or and turn the camera on.

"Turning the power on/off" (P.25)

To take pictures with the viewfinder, press to turn the viewfinder on.

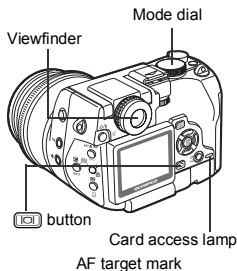

- 2 Compose the picture.

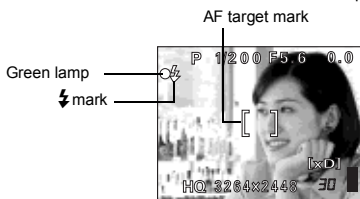

- 3 Press the shutter button gently (halfway) to adjust the focus.

- The AF target mark moves to the focus position.
- The shutter speed and aperture value automatically selected by the camera are displayed on the monitor (except in **M** mode).
- Monitor indications when the shutter button is pressed halfway are shown in the following table.

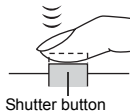

Indication		Meaning
mark	Lights	Flash stand-by. The flash fires when the shutter-release button is pressed all the way.
	Blinks	If the flash has popped up: flash is charging. Remove your finger from the shutter button and wait until the lamp goes off. If the flash is closed: camera movement warning. Press the flash pop-up button to open the flash.
Green lamp	Lights	The picture is in focus or the exposure is locked.
	Blinks	The picture is out of focus or the exposure is not locked. Also see TIPS on P.51.

- 4 Press the shutter button all the way (fully).

- The camera takes the picture.
- The card access lamp blinks while the picture is stored on the card.
- You can check the picture you have taken by pressing the QUICK VIEW button. "QUICK VIEW" (P.122)



● Canceling recording to the card

You can cancel recording to the card while the picture you have taken is being stored. Once recording to the card has been terminated, the picture will not be stored. You can cancel recording to the card when the picture was taken in RAW or TIFF record mode.  “Record mode” (P.102)

1 Press while the picture you have taken is being recorded to the card (while the card access lamp is blinking).

- The picture just taken is displayed on the monitor.

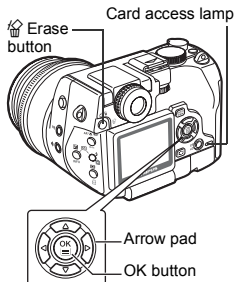

2 Press to select REC. START or REC. CANCEL (CANCEL ONE or CANCEL ALL), then press .

- REC. START** Recording to the card is resumed. The picture displayed on the monitor is stored on the card.
- REC. CANCEL** The picture displayed on the monitor is not stored on the card.



- REC. CANCEL is not displayed in sequential shooting mode or when several pictures are taken in succession. In this case, select CANCEL ONE or CANCEL ALL.

- CANCEL ONE** The picture displayed on the monitor is erased without being stored on the card. All other pictures are stored on the card.
- CANCEL ALL** None of the pictures taken is stored on the card.





TIPS

The subject cannot be focused on.

 “If correct focus cannot be obtained” (P.53)

The green lamp blinks.



- You are too close to the subject. Take the picture at least 20 cm (7.9") away from the subject. If you use the super macro mode, you can take pictures as close as 5cm/(1.2") from the subject.  “Super macro shooting” (P.88)
- Depending on the subject, the focus and exposure may not be locked.  “Subjects that are difficult to auto focus on” (P.54)

To check the picture you have just taken immediately.

→ Set REC VIEW to ON.  “REC VIEW – Checking the picture immediately after shooting” (P.147)

To record sound when taking pictures.

→ You can record sound when taking still pictures. Set  to ON.



 “Recording sound with still pictures” (P.100) You can also add sound to a picture that has already been taken.  “Recording sound” (P.137)

The viewfinder or monitor turned off.

→ The camera automatically enters the sleep mode and the viewfinder and monitor turn off after about 3 minutes of non-operation. Touch the shutter button or zoom lever to turn the viewfinder or monitor on again. You can select the length of time until the camera enters the sleep mode.

 “SLEEP – Setting the time until the camera enters sleep mode” (P.169)



To adjust the brightness of the viewfinder or monitor.

→ Select  in the mode menu and adjust the brightness.  “Adjusting the brightness of the monitor and viewfinder” (P.173)

The viewfinder or monitor is hard to see.

→ When you point the camera lens toward a bright subject, smears (lines like beams of light) may appear on the image in the viewfinder or on the monitor. This does not affect recorded pictures.

To check the area the camera is focusing on.

→ If you press  while pressing the shutter button halfway, the area you are focusing on is enlarged. Pressing  once more returns the size to normal. This function is not available in the digital zoom range.

 “Using the digital zoom” (P.58)



Note

- Press the shutter button gently using the ball of your finger. If it is pressed hard, the camera may move and pictures may come out blurred.
- Recorded pictures will be saved on the card regardless of whether the camera is turned off or the battery is replaced or removed.
- Do not open the card cover, remove the battery or connect/disconnect the AC adapter while the card access lamp is blinking. Doing so could destroy stored pictures and prevent storage of pictures you have just taken.
- When taking pictures against strong backlight, the area of the picture in shadow may appear colored.

If correct focus cannot be obtained

When the subject you want to focus on is not in the center of the frame and you cannot position the AF target mark on it, you can focus the camera on another point at roughly the same distance (focus lock) and take the picture as explained below.

Determine the position of the subject after focusing (Focus Lock)

Mode dial



1 Position the AF target mark on the subject you want to focus on.

- When shooting a hard-to-focus subject or a fast-moving subject, point the camera at an object about the same distance away as the subject.



AF target mark

2 Press the shutter button halfway and check that the green lamp lights steadily.

- When the focus and exposure are locked, the green lamp lights steadily.
- The AF target mark moves to the focus position.
- When the green lamp blinks, the focus and exposure are not locked. Release your finger from the shutter button, reposition your subject and press the shutter button halfway again.

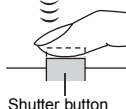

Shutter button

3 Keeping the shutter button pressed halfway, recompose your shot.

Green lamp



4 Press the shutter button all the way (fully).

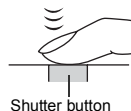

Shutter button



TIPS

The frame in which you focus on a subject is different from the frame in which you lock the exposure.

☞ "AE Lock - Locking the exposure" (P.85)

You want to focus on the center of the frame.

☞ "AF MODE - Changing the focus range" (P.74)

Subjects that are difficult to auto focus on

Under certain types of conditions, the auto focus may not work properly. If this happens, focus on an object with high contrast at the same distance as the intended subject (focus lock), recompose your shot and then take the picture. If the subject has no vertical lines, hold the camera vertically and focus the camera using the focus lock function by pressing the shutter button halfway, then return the camera to the horizontal position while keeping the button pressed halfway and take the picture.

If the subject still cannot be focused on, use the manual focus.

☞ "Manual focus" (P.79)

Green lamp blinks: the subject cannot be brought into focus.

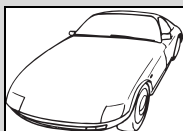

Subject with low contrast

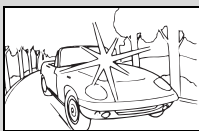

Subject with an extremely bright area in the center of the frame

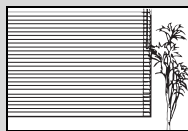

Subject without vertical lines

The green lamp lights, but the subject cannot be brought into focus.



Subjects at different distances

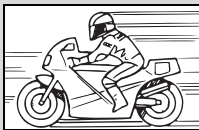

Fast-moving subject



The subject to be focused on is not in the center of the frame.



You can also record movies with this camera. Sound is recorded at the same time. The focus and zoom are locked. If the distance to the subject changes, focus may be compromised.

Mode dial



1 Set the mode dial to and turn the camera on.

 "Turning the power on/off" (P.25)

- The remaining recording time on the card that you are using is displayed on the monitor.

Mode dial

Power switch

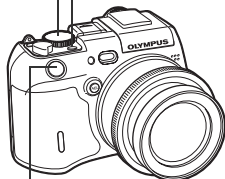

Shutter button

2 Compose the picture.

- You can use the zoom lever to enlarge your subject.



3 Press the shutter button fully to start recording.

- The focus and zoom are locked.
- During movie recording,  lights red.



Remaining recording time

4 Press the shutter button again to stop recording.

- When the remaining recording time has been used up, recording stops automatically.
- When there is space in the card memory, the remaining recording time is displayed, and the camera is ready to shoot the next movie.

 "Movie Record Modes" (P.104)

**TIPS****To keep your subject in focus all the time while shooting.**

The auto focus does not operate during recording when (movie) is set to ON.

→ Set (movie) to OFF and FULLTIME AF to ON. “FULLTIME AF - A reliable time-saving way to focus” (P.75)

To use the zoom while shooting.

The optical zoom is not available during recording when (movie) is set to ON.

→ Set DIGITAL ZOOM to ON. “Using the digital zoom” (P.58)

→ Set (movie) to OFF, and you can use the optical zoom while shooting.

“Recording sound with movies” (P.101)



Note

- Depending on the card, the remaining recording time may drop rapidly during recording. Try using the card again after formatting it.
 “Formatting cards” (P.166)
- When is set to ON, the movie is recorded with the focus that was set when the shutter button was pressed in Step 3. If the distance to the subject changes, focus may be compromised.
- In mode, the flash and manual focus (MF) cannot be used.

Notes for recording movies over a long time

- Recording will continue until the card is full unless stopped by pressing the shutter button.
- A long recorded movie cannot be edited. (P.130)
- If a single movie recording uses up all of the card's memory, create space on the card by deleting the movie or downloading it to a PC.

Zoom

Telephoto and wide-angle shooting are possible at 5× magnification (the optical zoom limit, equivalent to 28 mm to 140 mm on a 35 mm camera). By combining the optical zoom with the digital zoom, zoom magnification can be increased to a maximum of approximately 15×.

Camera movement is likely to occur at higher magnifications. Stabilize the camera with a tripod, etc. to avoid camera movement.

Using the optical zoom



1 Turn the zoom lever.

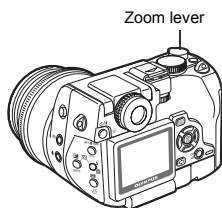

Wide-angle:
Turn the zoom lever toward
W to zoom out.

Telephoto:
Turn the zoom lever toward
T to zoom in.

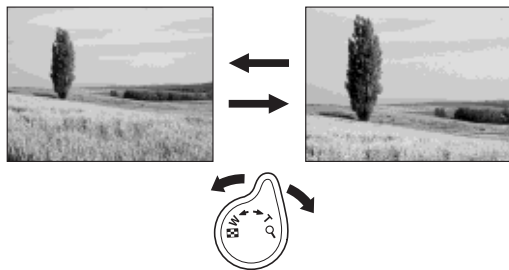

Using the digital zoom

Mode dial



- 1 In the top menu, select **MODE MENU** → **CAMERA** → **DIGITAL ZOOM** → **ON**, and press .

“Menu basics” (P.38)

- If DIGITAL ZOOM is displayed on the top menu as a shortcut menu, press the arrow pad in the same direction as the arrow shown next to DIGITAL ZOOM. “SHORT CUT” (P.157)
- Press again to exit the menu.

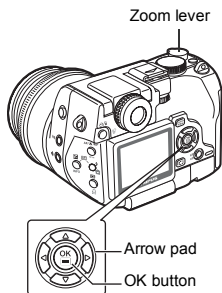

Mode dial



- 1 In the top menu, select **DIGITAL ZOOM** → **ON**, and press .
- 2 Turn the zoom lever toward **T**.

- The white area of the zoom indicator indicates the optical zoom. If the digital zoom is set to ON, a red area appears on the zoom indicator. When you reach the limit of the optical zoom, the digital zoom is enabled.



The cursor moves up and down on the zoom indicator according to the zoom magnification. The cursor turns orange when inside the digital zoom field.



- In mode, the maximum digital zoom magnification is 2.5×.
- Pictures taken with the digital zoom may appear grainy.

4 Flash

Flash shooting



Select the flash mode best suited to the light conditions and the effect you want to achieve. You can also adjust the amount of light emitted using the flash intensity control.



1 Press the flash pop-up button (1).

- The flash pops up (2).

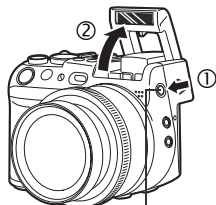

Flash pop-up button

Control dial

2 Set the flash mode by turning the control dial while holding down the flash mode button.

- The flash mode changes in the sequence shown below. (The selectable flash modes may differ depending on the shooting mode.)

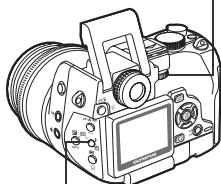

Flash mode button

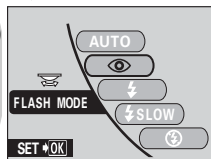
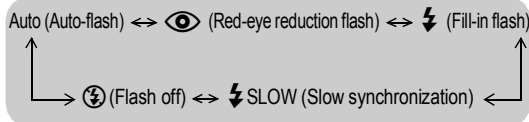

Flash mark

3 Press the shutter button halfway.

- The flash lights when the flash is ready to fire.

4 Press the shutter button fully to take the picture.



Flash working range

W (max.): Approx. 0.8 – 5.8 m (2.6 – 19 ft.)

T (max.): Approx. 0.2 – 4.0 m (0.7 – 13.1 ft.)

**TIPS**

The (flash charging) indication blinks.

→ The flash is charging. Wait until goes off.

Shutter speed when using the flash (Auto-flash, red-eye reduction, fill-in flash).

→ When lights, the flash fires automatically but the shutter speed locks at a level at which camera movement is not likely to occur. The level at which the shutter speed locks changes depending on the zoom position.

Zoom position	Shutter speed
W (max.)	1/30 sec.
T (max.)	1/125 sec.



Note

• AUTO, , and SLOW are not available in **S** and **M** modes.

• The flash does not fire in the following situations:

In mode, during sequential shooting (**HI** , , **AF** , **BKT**), during super macro shooting, during panorama shooting.

- The flash may not give you the optimum result in macro mode, especially with wide-angle shooting. Check the resulting picture on the monitor.
- When a conversion lens is attached to the camera, vignetting may occur. To take flash pictures, use an external flash.

● Auto-flash (No indication)

The flash fires automatically in low light or backlight conditions.

● Red-eye reduction flash ()

The light from the flash may make the subject's eyes appear red in the picture. The red-eye reduction flash mode significantly reduces this phenomenon by emitting pre-flashes before firing the regular flash. This helps accustom the subject's eyes to the bright light and minimizes the red-eye phenomenon.



The subject's eyes appear red.



Note

• After the pre-flashes, it takes about 1 second before the shutter is released. Hold the camera firmly to avoid camera movement.

• Effectiveness may be limited if the subject is not looking directly at the pre-flashes, or if the shooting range is too far. Individual physical characteristics may also limit effectiveness.

● Fill-in flash (⚡)

The flash fires regardless of the available light. This mode is useful for eliminating shadows on the subject's face (such as shadows from tree leaves), in a backlight situation, or for correcting the color shift produced by artificial lighting (especially fluorescent light).



Note

- The fill-in flash may not have the desired effect under excessively bright light.

● Flash off (⚡)

The flash does not fire even in low light conditions. Use this mode in situations where flash photography is not desired or is prohibited. You can also use this mode when you want to shoot a natural-looking twilight or night scene. Besides setting the mode to ⚡, flash does not fire when it is closed.



Note

- Since a slow shutter speed is automatically selected in low light situations when in the flash off mode, the use of a tripod is recommended to prevent your pictures from being blurred by camera movement.

● Slow synchronization (⚡ SLOW1 ⚡ SLOW2 🗨️ ⚡ SLOW1)

The slow synchronization flash is designed for slow shutter speeds. Normally, when shooting with a flash, shutter speeds cannot go below a certain level to prevent camera movement. But when shooting a night scene background, fast shutter speeds can make the background too dark. Slow synchronization flash allows both a slow shutter speed for the background and a flash for the subject. Since the shutter speed is slow, make sure you stabilize the camera by using a tripod. Otherwise, camera movement may cause the picture to be blurred. In **S** and **M** modes, the flash fires at the selected shutter speed.



1st curtain (front curtain) ⚡ SLOW1

Usually, regardless of the shutter speed, the flash fires right after the shutter fully opens. This is called 1st curtain. Unless you change it, this is how the flash always fires. The factory default setting for slow synchronization is ⚡ SLOW1.

2nd curtain (rear curtain) ⚡ SLOW2

The 2nd curtain fires just before the shutter closes. Changing the flash timing can create interesting effects in your picture, such as expressing the movement of a car by showing the tail-lights streaming backwards. The slower the shutter speed, the better the effects turn out.

The slowest possible shutter speed depends on the shooting mode:

A, S, M mode : 15 sec. (Bulb shot is available in **M** mode.)

P, [], **▲**, **📷**, **👤** mode : 4 sec.

When the shutter speed is set to 4 sec.

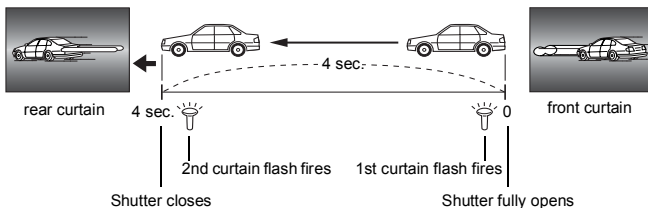

**1st curtain with red-eye reduction 👁️ ⚡ SLOW1**

This mode is for when you want to use slow synchronization, yet also reduce the red-eye phenomenon. For instance, when shooting a person against a brightly lit night background. A normal flash might make the person's eyes red, but 1st curtain with red-eye reduction lets you capture the background correctly and reduce the red-eye phenomenon at the same time. 2nd curtain with red-eye reduction is not available.

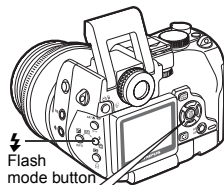

1 Press  while holding down .



2 Press   to select  SLOW, then press .

3 Press   to select  SLOW1,  SLOW or  SLOW2, then press .

- Press  again to exit the menu.

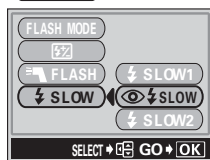



You can adjust the amount of light emitted by the flash. In some situations, you may get better results by adjusting the light emission. Examples include small subjects, distant backgrounds, or situations when increased contrast is desired.

Mode dial



- 1 Adjust the brightness by turning the control dial while holding down and at the same time.

Turning to the left decreases the light emission.

Min. setting is -2.0.



Turning to the right increases the light emission.

Max. setting is +2.0.

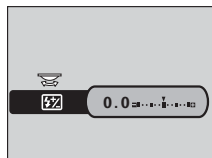
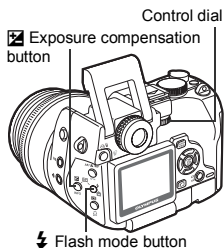

TIPS

- The flash intensity can be set in 1/3EV steps or 1/2EV steps.
 "EV STEP – Setting exposure adjustment increments" (P.153)



Note

- The flash adjustment effect may not be sufficient if the shutter speed is faster than 1/300.

Using an Olympus external flash

Various types of flash shooting are possible with the Olympus FL series external flashes.

If the external flash is used, flash mode and exposure compensation will be detected automatically by the camera, allowing the built-in flash and external flash to function together.

The external flash is mounted on the camera by attaching it to the hot shoe on the top of the camera. To use the external flash together with the built-in flash, the FL-BK01 flash bracket (optional) and FL-CB02 bracket cable (optional) are required.

This section explains how to use the FL-20 when attached to the hot shoe.







Mode dial

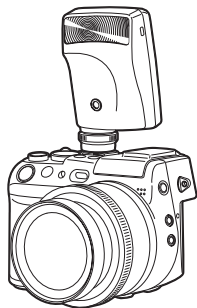
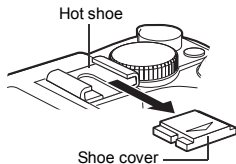

1 Slide the shoe cover off in the direction of the arrow and attach the external flash.



- For instructions on how to attach the flash, refer to the manual for the external flash.
- Keep the shoe cover in a safe place to prevent it getting lost, and replace it on the camera when you have finished using the external flash.



- 2** Press  while holding down .
- 3** Press   to select  FLASH, then press .

 "Menu basics" (P.38)

To use the external flash only

→ Select , then press .

To use the external flash together with the built-in flash, use Olympus flash bracket and the bracket cable (both optional).

→ Select IN+, then press .

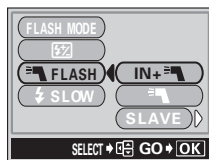

4 Turn on the external flash.

- Set the mode dial to TTL-AUTO.
- Be sure to attach the flash to the camera before turning the flash on.

5 Select the flash mode by turning the control dial while holding down .

 "Flash shooting" (P.59)



Note

- If close-up pictures are overexposed, try using the built-in flash by itself.
- When the built-in flash and the external flash are used together, the built-in flash is used as the compensating light source. This means that if the amount of light from the external flash is insufficient (beyond its working range), the resulting pictures may be underexposed.
- When shooting using a wide angle setting, confirm that the illuminating angle of the flash covers the angle of the 27mm lens (equivalent for 35mm camera).
- Using the Wide panel decreases the flash working range.

Using a commercially available external flash

Provided that the flash can be connected to the hot shoe, a commercially available external flash may be used. For details on compatible commercially available external flashes, refer to the next page. The amount of light emitted cannot be adjusted on commercially available external flashes except Olympus FL series. If the external flash gets in the way of the built-in flash when the flash pop-up button is pressed, use a flash bracket.

Mode dial



1 Attach the external flash to the hot shoe and connect it to the camera.

- For instructions on how to attach the flash, refer to the manual for the external flash.

2 Select M mode. Adjust the shutter speed and aperture.

"Manual shooting" (P.72)

- Remember that a slow shutter speed can produce blurred images. For the best results, we recommend that you set the shutter speed from 1/200 to 1/300 seconds.

3 Turn on the external flash.

- Be sure to attach the flash to the camera before turning the flash on.

4 Set the mode that automatically controls the amount of light emitted by the external flash. Also set ISO and aperture on the external flash to match the camera's settings.

- Refer to the user's manual for the external flash to select the mode.

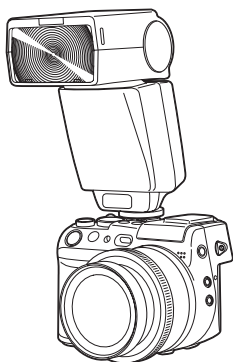

4

Flash



Note

- The camera's flash mode will have no effect on the external flash. The external flash will fire even when the camera's flash mode is set to (off).
- Confirm in advance that the external flash you are using is synchronized with the camera.

Compatible external flashes



When selecting an external flash, use products which meet the following basic conditions.



- (1) Some flashes available on the market operate with a high voltage synchro terminal. If one of these is used, it may damage the camera, and/or the camera may not function normally. Contact the manufacturer of the flash you are using concerning the specifications of the flash's synchro terminal.
- (2) Some flashes available on the market have the polarity of the synchro terminal reversed. In this case, even if the flash is connected, it will not fire. Contact the manufacturer of the flash for more information.
- (3) Exposures when using an external flash require that adjustments be made on the external flash unit. If an external flash is used in the auto mode, match it with the F value and ISO settings on the camera.
- (4) Even if the auto F value and ISO of the external flash are set to the same conditions as those on the camera, depending on the photographic conditions, it is possible that the correct exposure may not be obtained anyway. In such a case, adjust the auto F value or ISO value on the external flash unit or calculate the distance in the manual mode and use it that way.
- (5) Use a flash whose illuminating angle covers the angle of view of the lens. However, in close-up photography with the lens on the wide setting, the bottom of the image may not expose correctly. The ideal is to have a wide angle adapter to fit on the flash and spread the illumination angle so it is wider.
- (6) Use a flash unit with a flash time of 1/200 sec. or less when using the flash at full strength.
For devices with a long flash time, a portion of the light emitted will not contribute to the exposure.
- (7) **If a flash unit or other accessory TTL flash that has additional communications functions other than an Olympus FL series flash is used, it may not only fail to function normally, but may also cause damage to the camera's circuitry. Do not use such a device.**

Using the slave flash mode

This setting is for when using a commercially available slave flash that is synchronized with the camera flash.

The amount of light emitted by the flash can be adjusted in 10 levels. The flash can fire in sequential shooting mode, but the interval between shots will be longer if a high emission level is set.

AUTO,  : The setting is automatically changed to  (Fill-in flash).



  SLOW : The setting is automatically changed to  SLOW1.

Mode dial

A M

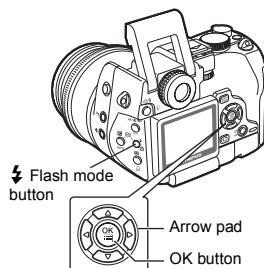
1 Press  while holding down .



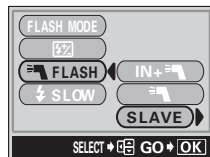

2 Select  FLASH → SLAVE, and press .

 "Menu basics" (P.38)

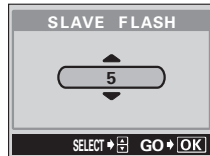

3 Press   to select an emission level from 1 to 10, then press .



4 Press  repeatedly until the menu disappears.

5 Advanced shooting

Aperture priority shooting

A**Mode dial**

1 Turn the control dial to set the aperture value.

Turn to the left to decrease the aperture value (F number).



Turn to the right to increase the aperture value (F number).

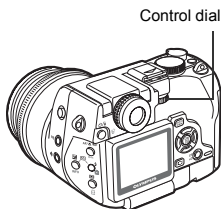

- You can change the adjustment range for the aperture. “EV STEP – Setting exposure adjustment increments” (P.153)
- If the aperture value is displayed in red, the setting is unsuitable for the conditions. Take the following steps. (If the shutter speed is displayed in green, the setting is suitable for the conditions.)

Aperture value

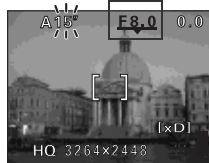

▲ appears: The image is overexposed. Turn the control dial to the right to increase the aperture value.

▼ appears: The image is underexposed. Turn the control dial to the left to reduce the aperture value.

Aperture range: Toward W: f2.4 to f8.0, Toward T: f3.5 to f8.0

**Note**

- When the flash is set to the auto-flash mode or the fill-in flash mode, the shutter speed is fixed at 1/30 sec. in the maximum wide angle, or 1/125 sec. in the maximum telephoto angle, and will not go slower.

Mode dial

1 Turn the control dial to set the shutter speed.

Turn to the left to set a slower shutter speed.



Turn to the right to set a faster shutter speed.

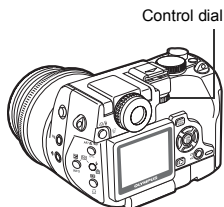

- You can change the adjustment range for the shutter speed. "EV STEP – Setting exposure adjustment increments" (P.153)
- If the shutter speed is displayed in red, the setting is unsuitable for the conditions. Take the following steps. (If the shutter speed is displayed in green, the setting is suitable for the conditions.)

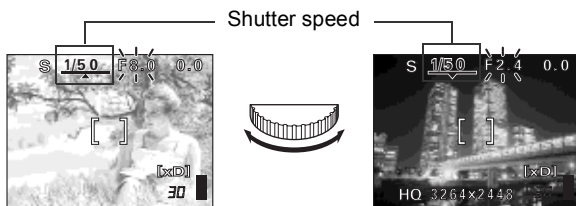

▲ appears: The image is overexposed. Turn the control dial to the right to set the shutter speed faster.

▼ appears: The image is underexposed. Turn the control dial to the left to set the shutter speed slower.

Shutter speed range : 15" to 1/4000



TIPS

Shutter speed indication

The actual shutter speed differs from the shutter speed displayed on the monitor. The actual shutter speed range of the camera is 16 to 1/4000 sec., but the speed is displayed in the range of 15" to 1/4000 on the monitor.



Note

- To avoid camera movement, you are recommended to use a tripod when taking pictures requiring a slow shutter speed.

Mode dial



1 Set the aperture by turning the control dial while holding down .

- You can change the adjustment range for the aperture and the shutter speed. “EV STEP – Setting exposure adjustment increments” (P.153)

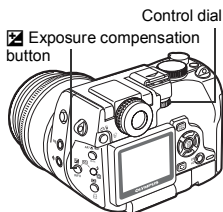

Turn to the left to decrease the aperture value (F number).

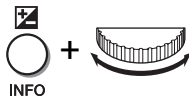

Turn to the right to increase the aperture value (F number).

Turn the control dial to set the shutter speed.

Turn to the left to set a slower shutter speed.



Turn to the right to set a faster shutter speed.

- When the shutter button is halfway pressed, the difference (ranging from -3.0 to $+3.0$ EV) between the two exposures is displayed. One is the exposure determined by the currently selected aperture and shutter speed, and the other is the exposure level considered optimal by the camera.
- If the exposure differential appears in red in the viewfinder or on the monitor, it indicates that the exposure differential is less than -3.0 EV or more than $+3.0$ EV.
- When you press the AEL (AE Lock) button, the screen on the right appears with the bar indicating the current exposure differential.

Exposure differential



Aperture value : f2.4 to f8.0
Shutter speed : 15" to 1/4000



TIPS

To take long exposure (bulb) shots

- Turn the control dial to the left to set the shutter speed to BULB.
- The shutter remains open as long as the shutter button is held down.
 - The maximum bulb length is 8 minutes.
 - Using the remote control prevents camera from shaking due to pressing the shutter by finger.
 - You can connect a remote cable (sold separately) with the power battery holder (also sold separately).



- To avoid camera movement, you are recommended to use a tripod when taking pictures requiring a slow shutter speed.

When you use mode, the settings you selected with the menus in My Mode are activated.

Saving the shooting mode or function settings you want to use in advance lets you shoot with your favorite settings straightaway. By setting the mode dial to , you can select whether to use one of the 8 customized My Mode settings that you have saved.

Mode dial



- 1 In the top menu, select **MODE MENU** → **CAMERA** → **MY MODE** → **MY MODE 1** to **MY MODE 8**, and press

“Menu basics” (P.38)

- Press again to exit the menu.
- Only the settings in MY MODE 1 have already been saved. You cannot select MY MODE 2 to MY MODE 8 if no settings have been saved in them.
 “MY MODE SETUP – Setting a function in My Mode” (P.160)

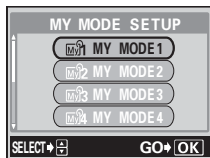
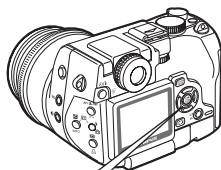

AF MODE - Changing the focus range

This function allows you to select the focus range of your subject.

iESP Even when the subject is not in the center of the screen, focusing is possible. The AF target mark moves to the focus position.

SPOT Focus selection is based on the subject within the AF target mark.

Mode dial



1 Press while holding down AF//MF.

- In MF or sMF mode, the menu is not displayed when is pressed.

AF//MF
AF/Macro/MF button

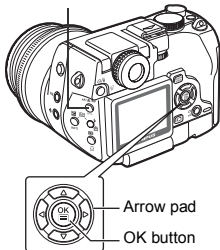

2 Press to select AF MODE, then press .

3 Press to select iESP or SPOT, then press .

- Press again to exit the menu.

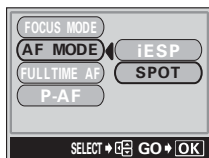

- In mode, the AF MODE is fixed to iESP. The setting cannot be changed.

Note

FULLTIME AF - A reliable time-saving way to focus

Focusing is performed repeatedly without having to press the shutter button halfway. When ON is selected, the focusing time is reduced, letting you take successive snapshots.



1 Press while holding down AF//MF.

- In MF or sMF mode, the menu is not displayed when is pressed.

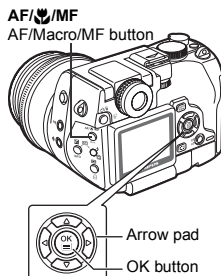

2 Press to select FULLTIME AF, then press .

3 Press to select ON or OFF, then press .

- Press again to exit the menu.

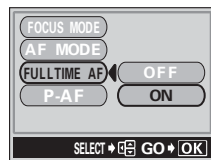

- In mode, FULLTIME AF does not operate when (movie) is set to ON.
- Battery consumption increases when FULLTIME AF is used.

P-AF – Changing the auto focus mode

For auto focusing, this camera is equipped with a contrast detection system measured by CCD and a phase difference detection system measured by AF sensor. You can select whether to use only the contrast detection system or to use the contrast detection system in conjunction with the phase difference detection system.

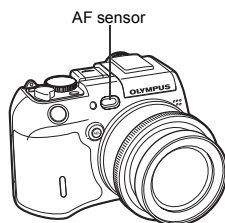

- OFF** The camera focuses on the subject using only the contrast detection system.
- ON** The camera focuses on the subject using both the contrast detection system and the phase difference detection system. Focusing is performed faster than when OFF is selected.



- 1 Press while holding down AF//MF.**
- In MF or MF mode, the menu is not displayed when is pressed.

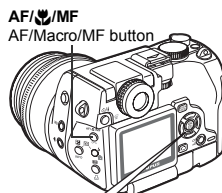

- 2 Press to select P-AF, then press .**
- 3 Press to select ON or OFF, then press .**
- Press again to exit the menu.

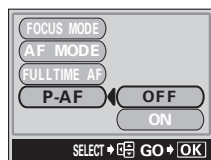

Note

- When the subject is within 80 cm (2.6 ft.) of the camera, the camera focuses using only the contrast detection system.
- Focusing may take some time if P-AF is set to ON when a conversion lens or underwater housing is attached to the camera.
- In mode, P-AF is fixed to OFF. The setting cannot be changed.
- When the position of the AF target mark has been moved, P-AF is automatically set to OFF.
- "Changing the position of the AF target mark" (P.77)

Changing the position of the AF target mark

This function lets you select the area you want to focus on by changing the position of the AF target mark.



1 Set the AF mode to SPOT.

- Press "AF MODE - Changing the focus range" (P.74)

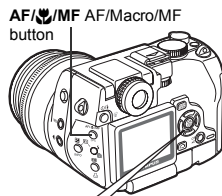

2 Hold down AF/MF and use the arrow pad to move the AF target mark to the area you want to focus on.

- In MF or sMF mode, the AF target mark does not move when the arrow pad is pressed.

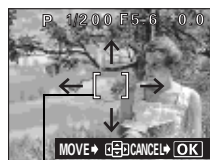

AF target mark

3 Take the picture.

- To restore the AF target mark to its original position (in the center), press while holding down AF/MF on the right screen.



Note

- Turning the camera off or changing the shooting mode will return the AF target to the center position.
- The AF target mark cannot be moved when the digital zoom is on.

AF illuminator

The AF illuminator allows the auto focus to focus on dark subjects. When the shutter button is pressed halfway, the AF illuminator fires automatically, lighting up the subject. Factory default setting is ON. To turn the AF illuminator off, follow the procedure below.

Mode dial

SET UP

- 1 Select **SETUP** → **AF ILLUMINATOR** → **OFF**, and press .

 "Menu basics" (P.38)

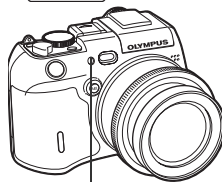
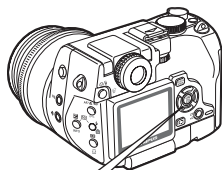

AF illuminator



Note

- Even when the AF illuminator is lit, the auto focus may still not be able to focus properly on subjects within 80 cm (2.6 ft.) of the camera.

Manual focus

If auto focus is unable to focus on a subject, use manual focus.



- 1 Turn the control dial while holding down AF//MF and select MF.

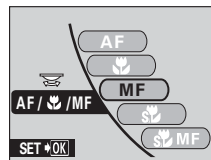
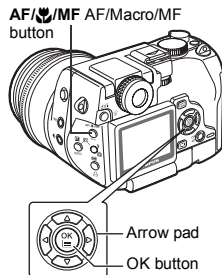

- When you release your finger from the AF//MF button, the distance indicator is displayed on the monitor.



- 2 Press to set the focus.

- During operation, the area in the middle is enlarged. This lets you check whether the focus is correct.
- The distance indicator on the left of the monitor is for reference only.
- When the indicator is moved to less than 0.8 m (2.6 ft.), the display automatically switches to the 20 cm (8") to 80 cm (2.6 ft.) display.

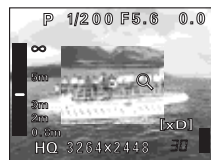

- 3 Take the picture.

- The focus is locked at the distance you have set.

**TIPS****How to shoot while keeping the same focus distance**

→ Decide the focus in Step 2, then press . The focus is locked and **MF** appears in red on the monitor.

To fix the focus at the same distance as the focus lock position

- 1 Position the AF target mark on a subject at the desired distance and press the shutter button halfway.
- 2 Keeping the shutter button half-pressed, press **AF/****/MF**.
 - The distance indicator is displayed.
 - MF is selected and the focus is locked at the same distance as when you performed focus lock.
 - Set to AF to return to auto focus.

Even if you move the cursor to the top of the distance indicator, focusing is not possible at ∞.

→ Adjust the cursor position by pressing .

How to take pictures very close to the subject

→ In super macro MF mode, pictures as close as 5cm from the subject can be taken with manual focus. Turn the control dial while holding down **AF/****/MF** and select **MF**. “Super macro shooting” (P.88)



Note

- When the digital zoom is set to $\times 2.5$ or more, the area you are focusing on is not enlarged.
- If the zoom lever is pressed after performing manual focus, the saved focus distance may be changed. Perform setting again.



There are four ways of measuring the brightness of a subject. Select the way best suited to your purpose.

Digital ESP metering Meters the center of the subject and the surrounding area separately.

Spot metering (☐) Exposure is determined by metering within the metering target area. In this mode, a subject can be shot with optimal exposure regardless of the background light. P.81

Multi-metering (☐MULTI) Meters the brightness of the subject at up to 8 different points to set the optimal exposure based on the average brightness. This method is useful with a high contrast subject. P.83

Center-weighted metering (☐) Meters the brightness over a wide area with emphasis on the center of the screen. This method is used when you do not want to let the brightness of the surrounding area affect the picture. P.81

Spot metering / Center-weighted metering – Selecting the metering area



- 1 Turn the control dial while holding down and select or .

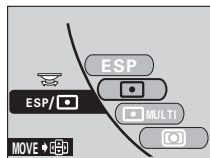
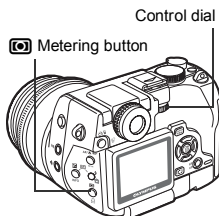

Changing the position of the metering target mark

When the metering mode is set to SPOT, you can select the metering area by moving the position of the target mark.



- 1 Turn the control dial while holding down to select .

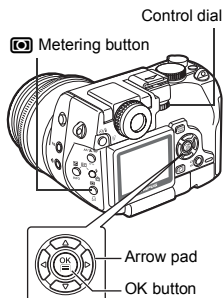

- 2 Hold down and use the arrow pad to move the metering target mark to the area you want to meter.

Metering target mark

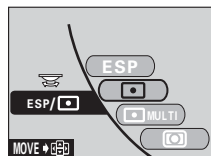

- 3 Take the picture.

- To restore the metering target mark to its original position (in the center), press while holding down in Step 2.





- Turning the camera off or changing the shooting mode will return the metering target to the center position.

Multi-metering

– Metering the exposure at more than one point  **MULTI**



- 1 Turn the control dial while holding down  and select  **MULTI**.

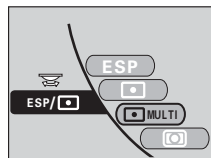
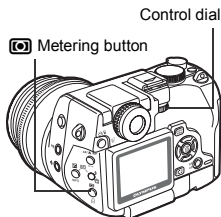

- 2 Position the AF target mark on the area you want to meter and press the AEL (AE Lock) button. The brightness is metered at up to 8 different points.

- The multi-metering bar appears.
- Additional metering is ignored after the 8th reading.
- To perform metering again, press the AEL button for more than 1 second to display **MEMO**. Press the AEL button again to cancel the metering values.

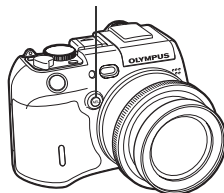

Ex: When metering 2 points (pressing the AEL button twice)

The aperture and shutter speed as calculated from the average values obtained by metering at 2 points. These values are recalculated every time another metering point is added.

The average for the 2 metering points.

The average is always shown at the center of the bar.



Indicates how much the present exposure you are metering differs from the average exposure value. The present exposure can be fixed by pressing the shutter button halfway. (The present exposure is not added to the average value unless you press the AEL button.)

The reading when the AEL button was pressed. The number of \diamond indicates the number of times you have pressed the button. The distance \diamond is from the center of the bar indicates the difference between the metered and average readings.

When \diamond moves more than ± 3 from the center of the bar (the average reading), red $\triangleleft \triangleright$ appear.



TIPS

To save the locked multi-metering exposure after shooting (AE memory)

→ After metering in Step 2, hold down the AEL button for more than 1 second. **MEMO** appears. While **MEMO** is displayed, the exposure is saved. Press the AEL button again to cancel the AE memory.

The multi-metering exposure is canceled.

→ If you operate any of the buttons or the mode dial after metering in Step 2, the multi-metering exposure is canceled.

This function is suitable for situations when optimal exposure is difficult to achieve, such as when there is excessive contrast between the subject and the surroundings.

For example, when the sky takes up much of the frame, shooting with automatic exposure sometimes results in a dark subject. Recompose your shot so that not much sky is in the frame, and then press the AEL button to lock the metered value (exposure) temporarily. Next, compose your shot again with the sky in the frame and take the picture.



1 Compose the picture where you want to lock the metered value (exposure), then press the AEL button.

- The metered value is saved.
- If you want to lock a different exposure, press the AEL button again to cancel AE lock. Each time you press the AEL button, AE lock is engaged and canceled repeatedly.

AEL button

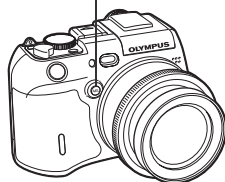

2 Position the AF target mark on the subject you want to focus on and press the shutter button halfway.

- The green lamp lights.



During AE lock, AEL is displayed.



3 Press the shutter button fully.

- AE lock is automatically canceled after one shot.

**TIPS****To save the locked multi-metering exposure after shooting (AE memory)**

→ After setting AE lock in Step 1, or after pressing the shutter button halfway in Step 2, hold down the AEL button for more than 1 second. **MEMO** appears. While **MEMO** is displayed, the exposure is saved. Press the AEL button again to cancel the AE memory.

AE lock was canceled.

→ Do not operate any of the buttons or the mode dial after performing AE lock. Doing so will cancel AE lock.
→ The camera had emerged from sleep mode or the power was turned off.



Note

- AE lock is not available when multi-metering is enabled. Set the metering method to ESP, or . “Metering” (P.81)
- AE lock is not available when a menu is displayed on the screen. “Menu basics” (P.38)
- AE lock is not available when the control panel is displayed on the screen. “CONTROL PANEL – Using the monitor as a control panel” (P.163)

Macro mode shooting



Focusing is usually slow when you get close to a subject (20 cm to 80 cm (0.7 ft. to 2.6 ft.)). However, in the  mode focusing is performed quickly.



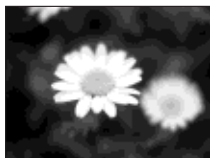

Normal shooting



Macro shooting



- 1 Turn the control dial while holding down AF//MF and select .

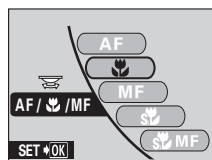
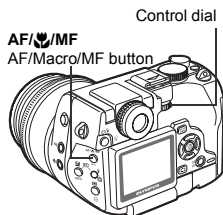

Note

- If you use the flash in macro shooting, shadows may be noticeable and the correct exposure may not be achieved.

5

Advanced shooting

In super macro mode, pictures can be taken as close as 5cm (2.0") from the subject. Subjects measuring up to approximately 4.8 cm × 3.6 cm (1.9" × 1.4") can be captured on the monitor.

In the mode, normal shooting is also possible, but the zoom cannot be used.

Mode dial



- 1 Turn the control dial while holding down **AF//MF** and select .

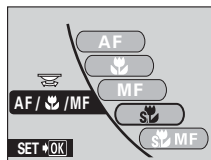
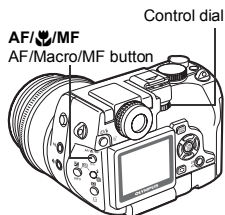

● Super macro MF

When taking pictures close to the subject, shadows may become noticeable, and the auto focus may not be able to maintain correct focus. Set the camera to super macro MF and use manual focus.

- 1 Turn the control dial while holding down **AF//MF** and select MF.
- 2 When you release your finger from the **AF//MF** button, the distance indicator is displayed on the monitor.
 - During operation, the area in the middle is enlarged. This lets you check whether the focus is correct.
- 3 Press to adjust the focus.
 - Pressing locks the focus position and MF appears in red on the monitor.



- During super macro shooting, the built-in flash is not available. You can use an external flash, but vignetting may occur. Display the recorded image on the monitor to check it.



This function lets you take pictures using the self-timer. Fix the camera securely on a tripod for self-timer shooting. This function is useful for taking pictures where you want to be included in the photograph.

Mode dial



- 1 Turn the control dial while holding down and select .

Self-timer/
Remote control button Control dial

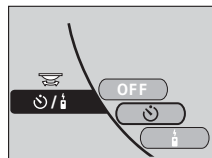
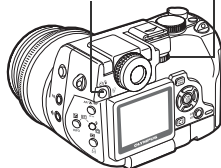

- 2 Press the shutter button fully to start self-timer shooting.

- Pressing the shutter button halfway locks the focus and exposure.
- The self-timer/remote control lamp lights for approximately 10 seconds, then starts blinking. After blinking for approximately 2 seconds, the picture is taken.
- To stop shooting while in mode, press the shutter button fully again.
- To cancel the self-timer, press .
- The self-timer mode is automatically canceled after one shot.

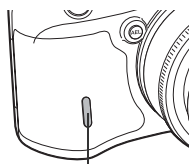

Self-timer/
Remote control lamp



- If self-timer shooting is attempted in sequential shooting mode, the camera shoots 5 frames at most, regardless of the setting.

Note

Remote control shooting



Shooting is possible using the remote control device provided with the camera. This is useful when you want to take a picture of yourself in it, or a night scene, without touching the camera.

Mode dial



P

A

S

M



- 1 Mount the camera on a tripod or place it on a stable, flat surface.
- 2 Turn the control dial while holding down  and select .

 Self-timer/
Remote control button

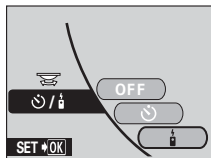
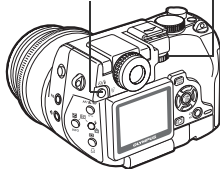

Control dial

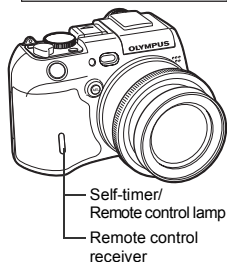
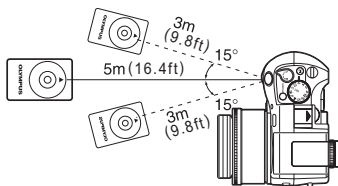

- 3 Point the remote control device at the remote control receiver on the camera.



- 4 Press the shutter button on the remote control device.

- The focus and exposure are locked and the self-timer/remote control lamp blinks before taking the picture.
- You can set the time until the picture is taken.  "Changing the time until remote control is activated" (P.91)
- To shoot in bulb mode, press and hold down the shutter button on the remote control device.  "Manual shooting" (P.72)

5

Advanced shooting

**TIPS**

The self-timer/remote control lamp does not blink after pressing the shutter button on the remote control device.

- The remote control device may be too far from the camera. Move closer to the camera and press the shutter button on the remote control device again.
- The battery in the remote control device is running low. Replace with a new battery. "How to replace the battery (CR2025) of the remote control device" (P.220)

How to cancel the remote control mode.

- The remote control mode is not canceled automatically after shooting. Perform Step 2 and set the mode to OFF.



Note

- If the remote control receiver is exposed to strong light, the effective signal distance may be reduced or shooting may not take place.
- To shoot sequential shots using the remote control device, press and hold the shutter button on the remote control device. If the camera does not receive the remote control signal properly, sequential shooting may stop.

Changing the time until remote control is activated

You can select the time from when the shutter button on the remote control device is pressed until the picture is taken.

- AUTO** The picture is taken immediately the shutter button on the remote control device is pressed.
- 3 SEC** The picture is taken approximately 3 seconds after the shutter button on the remote control device is pressed.

1 Press while holding down .

- In mode, the menu is not displayed when is pressed.

Self-timer/Remote control button

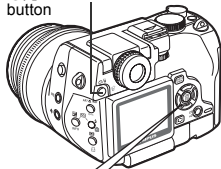

2 Press to select AUTO or 3 SEC, then press .

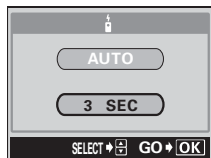



There are 4 sequential shooting modes: high speed sequential shooting, sequential shooting, AF sequential shooting and auto bracketing. Except for auto bracketing, the exposure and white balance are locked at the first frame. Sequential shooting cannot be performed when the record mode is set to TIFF.

Sequential shooting mode

- Shoots one frame at a time when the shutter button is pressed. (Normal shooting mode, single-frame shooting)
- HI** Pictures can be taken at a faster speed than normal sequential shooting.
Approx. 5 frames at 1.6 frames/sec.
- The focus is locked at the first frame. The sequential shooting speed varies depending on the record mode setting.
Approx. 17 frames (in HQ mode) can be taken in sequence.
- AF** Adjusts the focus 1 frame at a time. The AF sequential shooting speed is slower than normal sequential shooting.
- BKT** "Auto bracketing" (P.93)

High speed, sequential and AF sequential shooting



Mode dial



1 In the top menu, select **MODE MENU** → **CAMERA** → → **HI** , or **AF** , and press .

"Menu basics" (P.38)

- If is displayed on the top menu as a shortcut menu, press the arrow pad in the same direction as the arrow shown next to .

"SHORT CUT" (P.157)

- Press again to exit the menu.

2 Take the picture.

- The camera will take pictures in sequence until you stop holding down the button.

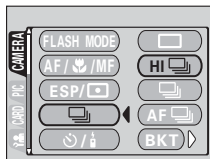
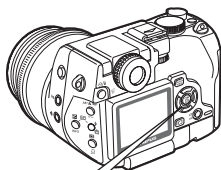

Auto bracketing

BKT

Under some conditions, you may obtain better results shooting with exposure compensation than by using the exposure setting considered optimal by the camera.

When auto bracketing is set, the exposure is changed automatically for each frame while the shutter button is pressed. The exposure differential and number of frames can be selected in the menus. The focus and white balance are locked at the first frame.

Ex : When BKT is set to $\pm 1.0 \times 3$



-1.0



0.0

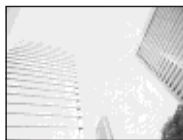

+1.0

Mode dial

- 1 In the top menu, select **MODE MENU** → **CAMERA** → → **BKT**, and press .
 “Menu basics” (P.38)

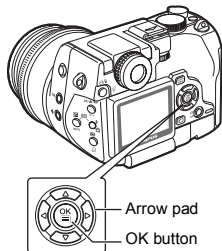

- 2 Select the exposure. Press to select **± 0.3 , ± 0.7 or ± 1.0** , then press .
 - When the exposure adjustment is set to 1/2 EV steps, select from ± 0.5 and ± 1.0 .
 - “EV STEP – Setting exposure adjustment increments” (P.153)

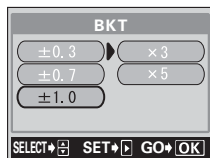

- 3 Select the number of pictures. Press to select **$\times 3$ or $\times 5$** , then press .
 - In some combinations of picture size and record mode, only $\times 3$ is available.
 - Press repeatedly until the menu disappears.

4 Take the picture.









- Press the shutter button fully and keep it pressed to shoot the preset number of pictures. You can stop shooting at any time to stop holding down the shutter button.

5

Advanced shooting



Note

- Sequential shooting (**HI** , , **AF** , **BKT**) is not possible in the following situations:
 - When the record mode is set to TIFF
 - When NOISE REDUCTION is set to ON
-  and **AF**  are not available when the record mode is set to RAW.
- In sequential shooting mode (**HI** , , **AF** , **BKT**), the built-in flash does not fire. The external flash does not fire in **BKT** mode.
- Auto bracket shooting is not available in **M** mode.
- Since the shutter speed is set to 1/30 sec. max. except in **S** and **M** mode, exposure is decreased when shooting a dark subject to prevent camera movement.
- For auto bracketing in modes other than **S** mode, shooting is automatically set to 1/30 sec. if the shutter speed was other than 1/30 sec. for an exposure differential of 0.
- If the battery power is low and the battery check blinks during sequential shooting, shooting stops and the camera starts saving the pictures you have taken. Whether or not all of the shots are saved depends on how much battery power remains.
- In Auto bracket shooting, if available space on the card does not exceed the number of set pictures, the next picture may not be taken.

Panorama shooting

You can take advantage of PANORAMA shooting with the Olympus xD-Picture Card. PANORAMA shooting lets you connect pictures with overlapping edges into a single panoramic picture, using the CAMEDIA Master software.

Mode dial



- 1 In the top menu, select **MODE MENU** → **CAMERA** → **FUNCTION** → **PANORAMA**, and press .

“Menu basics” (P.38)

- The PANORAMA mode is set.

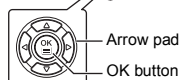
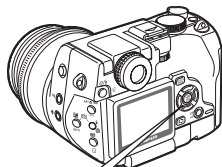

- 2 Use the arrow pad to choose the direction in which you want the pictures connected.

- : Connects the pictures from left to right.
- : Connects the pictures from right to left.
- : Connects the pictures from bottom to top.
- : Connects the pictures from top to bottom.

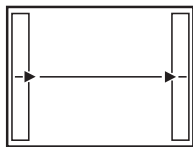

Connecting pictures from left to right

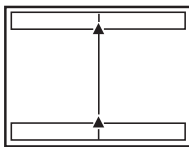

Connecting pictures from bottom to top

- 3 Take pictures so that the edges overlap.

- Focus, exposure and white balance are set by the first picture. Do not select an extremely bright subject (such as the sun) for the first picture.
- You cannot adjust the zoom after the first picture.
- Panorama shooting is possible for up to 10 pictures.

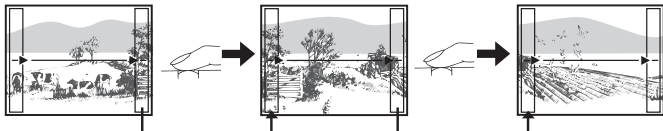

Keeping the area in the frame at the edge of the screen in mind, position the camera so that the same area appears in the frame for the next picture. Compose the picture so that the section that appeared at the right edge of the previous picture (or the left edge if you are connecting pictures from right to left) appears at the left edge of the next picture (or the right edge if you are connecting pictures from right to left).

- When you have taken 10 pictures, a warning mark appears.





4 Press to exit PANORAMA shooting.

- The frame on the screen disappears and the camera returns to the normal shooting mode.



Note

- The PANORAMA mode is only available with Olympus CAMEDIA-brand cards.
- During PANORAMA shooting, the flash, sequential shooting (**HI** , , **AF** , **BKT**) and program shift modes are not available.
- Images are saved in JPEG format when PANORAMA shooting is performed in the TIFF mode. The size of the image does not change.
- PANORAMA shooting is not available when the record mode is set to RAW.
- If the mode dial is operated during PANORAMA shooting, the camera cancels the PANORAMA mode and returns to normal shooting.
- The camera itself cannot connect panorama pictures. The CAMEDIA Master software is necessary to connect the pictures.



This function displays a silhouette of guideline on the monitor to help you compose your pictures. Select the type of guideline best suited to your purpose.



- 1 In the top menu, select **MODE MENU** → **CAMERA** → **FUNCTION** → , and press .

"Menu basics" (P.38)

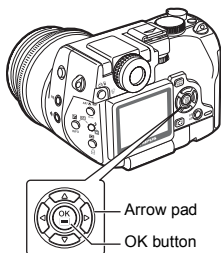

- 2 Press to select the guidelines, then take the picture.

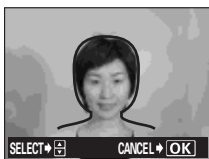

Horizontal position

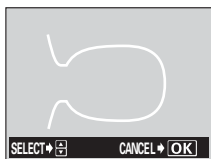

Vertical position

- 3 Press to exit guideline shooting.

- The guidelines on the screen disappear and the camera returns to the normal shooting mode.



TIPS

- You can display the guidelines in the playback mode too.
 "Displaying guidelines" (P.136)



Note

- The guidelines do not appear on the resulting picture.

Shooting in black & white or sepia-tone

This setting lets you add special effects to pictures.

Mode dial



- 1 In the top menu, select **MODE MENU** → **CAMERA** → **FUNCTION** → **BLACK & WHITE** or **SEPIA**, and press

"Menu basics" (P.38)

- Press again to exit the menu.

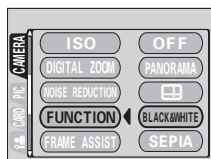
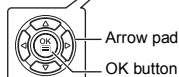
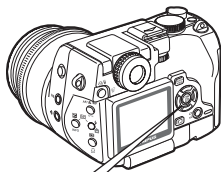

Note

- White balance, white balance compensation, hue and saturation cannot be used in black & white or sepia shooting.

FRAME ASSIST – Displaying vertical and horizontal lines to aid composition

This setting displays a vertical and horizontal lines on the monitor to help you compose your pictures.

Mode dial



- 1 In the top menu, select **MODE MENU** → **CAMERA** → **FRAME ASSIST** → **ON** or **OFF**, and press

“Menu basics” (P.38)

- Press again to exit the menu. The vertical and horizontal lines are displayed on the monitor.

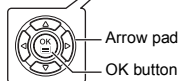
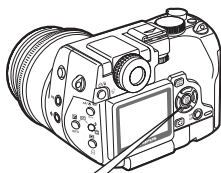

Note

- The frame is not displayed in the following cases.
During panorama or guideline shooting

5

Advanced shooting



This function lets you record sound when taking a still picture. Recording starts about 0.5 seconds after the shutter is released and lasts about 4 seconds. When this function is enabled, sound is recorded automatically every time you take a picture.

Mode dial



- In the top menu, select **MODE MENU** → **CAMERA** → (for still pictures) → **ON**, and press .

"Menu basics" (P.38)

- Press again to exit the menu.

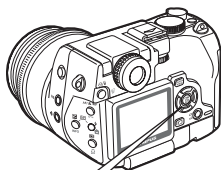

- When recording starts, turn the camera microphone towards the source of the sound you want to record.

- The **BUSY** bar is displayed during recording.

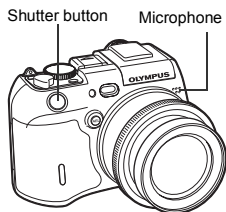

TIPS

- appears on the monitor during playback of still pictures and movies with sound. During playback, sound is output from the speaker. The volume can be adjusted. "VOLUME – Adjusting the playback volume" (P.165)
- Sound can be added later to still pictures. Recorded sound can also be changed. "Recording sound" (P.137)



Note

- If the camera is more than 1 m (3.3 ft.) away from the source of the sound, sound may not be recorded clearly.
- It is not possible to take another picture during sound recording.
- Sound recording is not possible in the following cases:
When the record mode is set to TIFF, during sequential shooting (**HI**, **AF**, **BKT**) or panorama shooting
- Sound recording may also pick up camera noises, such as button operations, shutter movement, etc.
- Sound recording may not be possible if there is insufficient space in the card memory.



Sound can be recorded while shooting a movie.

Mode dial



- 1 In the top menu, press to select (movie).

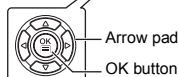
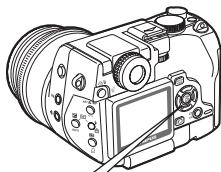

- 2 Press to select ON, then press .



- 3 Recording starts at the same time as shooting.



Note

- When is set to ON, the focus and optical zoom are locked during movie recording. If is set to OFF, you can use both the optical zoom and digital zoom during movie recording.
- If the camera is more than 1 m (3.3 ft.) away from the source of the sound, sound may not be recorded clearly.

6 Adjusting the image quality and exposure

Record mode



You can select a record mode in which to take pictures or shoot movies. Choose the best record mode for your purpose (printing, editing on a PC, website editing, etc.). For resolutions and file sizes in the different record modes, refer to the table on P.104.

Normal image mode

← Image becomes clearer

Application	Compression		Un-compressed	Low compression	High compression
	Resolution				
Select for the print size	3264 × 2448	TIFF		SHQ	HQ
	2592 × 1944			SQ1 HIGH	SQ1 NORMAL
	2288 × 1712				
	2048 × 1536			SQ2 HIGH	SQ2 NORMAL
	1600 × 1200				
	1280 × 960				
1024 × 768					
For small sized prints and website	640 × 480				

Number of pixels increase ↑

● Resolution

The number of pixels (horizontal × vertical) used when saving an image. If the image will be printed, higher resolutions (larger numbers) are recommended so that the image will be clearer. However, higher resolutions make the file size (amount of data) larger, so the number of pictures that can be saved will be fewer.

● Compression

In record modes other than TIFF, image data are compressed. The higher the compression, the less clear the image will be.

● Resolution and picture size on a computer screen

When a picture is transferred to a computer, the size of the picture on the computer screen varies depending on the computer's monitor setting. For instance, a picture taken in 1024 × 768 resolution is the same size as the screen if you set the picture to 1× when the monitor setting is 1024 × 768. However, if the monitor setting is over 1024 × 768 (such as 1280 × 1024), the picture only takes up part of the screen.

Special image mode

Record mode	Features	Resolution
RAW	As the name suggests, the data is “raw”, not having been subjected to image processing.	3264 × 2448
3:2 (TIFF, SHQ, HQ)	This mode is useful when having prints made at a photo lab.	3264 × 2176

RAW Data

As its name suggests, RAW data is unprocessed image data in its original state to which white balance, sharpness, contrast, color conversion and other processes have not been applied on your PC. CAMEDIA Master software is required to display RAW data on your PC as images. Plug-in software for playback by Photoshop can also be used. (Available for download from the Olympus home page.) You cannot display RAW data using ordinary software or make print reservations.

Pictures taken in the RAW data format can be edited on this camera.

 “RAW editing” (P.140)

3:2 Resolution

The image aspect ratio is normally 4:3. If the aspect ratio is changed to **3:2**, the image can be printed at a photo lab without losing the image borders. **3:2** is not available in  mode.

Check the shooting range on the monitor before taking the picture.



Monitor indications when **3:2** is set

● Record modes and the number of storable still pictures

The number of storable still pictures can be estimated by dividing the capacity of the card by the file size. When a card is inserted in the camera, it is displayed in the viewfinder or on the monitor.

The file size and the remaining recording time in the following table are the estimated numerical value.



Number of storable still pictures

Still Picture Record Modes

Record mode	Resolution		Compression	File format	File size (MB)	
					With sound	Without sound
RAW	3264 × 2448		Uncompressed	ORF	11.5	11.4
TIFF	3264 × 2448		Uncompressed	TIFF	22.9	22.9
	3:2	3264 × 2176			20.3	20.3
		2592 × 1944			14.4	14.4
		2288 × 1712			11.2	11.2
		2048 × 1536			9.0	9.0
		1600 × 1200			5.5	5.5
		1280 × 960			3.5	3.5
		1024 × 768			2.3	2.3
SHQ	3264 × 2448		Low compression	JPEG	3.9	3.8
	3:2	3264 × 2176			3.4	3.4
HQ	3264 × 2448		High compression	2.0	1.7	
	3:2	3264 × 2176		1.7	1.2	
SQ1	2592 × 1944	HIGH	*	JPEG	3.6	3.6
		NORMAL			1.2	1.2
	2288 × 1712	HIGH			2.8	2.8
		NORMAL			1.0	0.9
	2048 × 1536	HIGH			2.3	2.2
		NORMAL			0.8	0.8
SQ2	1600 × 1200	HIGH			1.4	1.4
		NORMAL			0.5	0.5
	1280 × 960	HIGH			0.9	0.9
		NORMAL			0.3	0.3
	1024 × 768	HIGH			0.6	0.6
		NORMAL			0.2	0.2
	640 × 480	HIGH	0.3	0.2		
		NORMAL	0.1	0.1		

*HIGH uses low compression/NORMAL uses high compression

Movie Record Modes

Record mode	Resolution	Remaining recording time (sec.)	
		32MB	
		With sound	Without sound
SHQ	640 × 480 (15 frames/sec.)	34	35
HQ	320 × 240 (15 frames/sec.)	93	96
SQ	160 × 120 (15 frames/sec.)	374	424



Note

- The number of storable still pictures that can be taken may change according to the subject or factors such as whether print reservations have been made or not. In certain instances, the number of remaining pictures displayed on the monitor does not change even when you take pictures or stored images are erased.
- In some cases, the larger the capacity of the card, the greater the difference between the calculated number of pictures and the actual number of pictures.
- If movies are shot with VIDEO OUT set to PAL and the AV cable connected, the movie recording time will differ from the time listed in the Movie Record Modes table.

Selecting a record mode



- 1 Turn the control dial while holding down to select the record mode.

- The record mode changes in the sequence shown below.

Still Picture Record Modes



Movie Record Modes

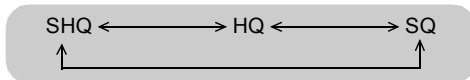

- 2 If you selected a still picture record mode, press while holding down to display the screen for selecting the resolution.
- 3 If you selected TIFF, SHQ or HQ, press to select a resolution, then press . If you selected SQ1 or SQ2, press to select a resolution, then press . Press to select HIGH or NORMAL, then press .

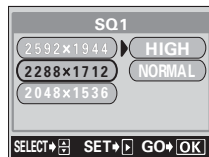
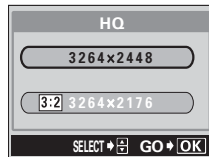
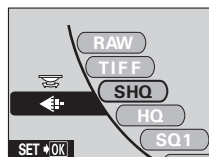
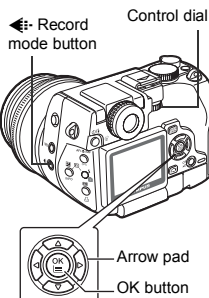



● JPEG duplicate setting

Pictures taken in the RAW data format can be stored in JPEG format at the same time as they are recorded in RAW data. To record pictures in JPEG format you can select SHQ, HQ, SQ1 or SQ2 for the record mode, but you cannot select a resolution. Pictures are recorded in the resolution currently set for each record mode.

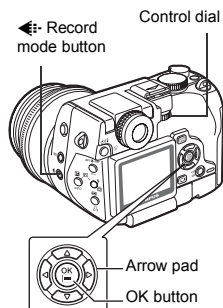
- 1 Turn the control dial while holding down  to select RAW.



- 2 While holding down , press .
- 3 Press   to select OFF, SHQ, HQ, SQ1 or SQ2, then press .

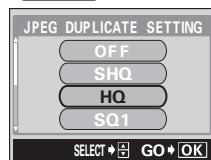

ISO – Set-up appropriate sensitivity

The higher the ISO settings, the greater the camera's light sensitivity and the better its ability to shoot in low light conditions. However, higher values also introduce noise into the resulting image, which may give them a grainy appearance.

AUTO Sensitivity is automatically adjusted according to the light conditions and the subject brightness.

50 to 400 With a lower ISO setting, you can shoot clear, sharp images in daylight. With a higher ISO setting, you can use faster shutter speeds with the same amount of light. The available ISO settings vary depending on the EV step setting.  "EV STEP – Setting exposure adjustment increments" (P.153)

Mode dial



1 In the top menu, select **MODE MENU** → **CAMERA** → **ISO** and press .

 "Menu basics" (P.38)

- If ISO is displayed on the top menu as a shortcut menu, press the arrow pad in the same direction as the arrow shown next to ISO.

 "SHORT CUT" (P.157)

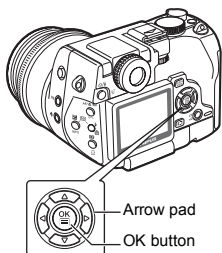

Mode dial



1 In the top menu, press  to select ISO.

2 Press   to choose the most suitable ISO value, then press .

- AUTO is not available in **A**, **S** or **M** mode.
- Press  again to exit the menu.



Note

- Higher ISO settings produce more electrical noise.
- When ISO sensitivity is set to AUTO and you are shooting in dark conditions without a flash, the sensitivity automatically increases, otherwise the shutter speed will be reduced, possibly resulting in camera movement and blurred images.
- If the subject is too far away for the flash illumination to reach when ISO sensitivity is set to AUTO, the sensitivity is automatically increased.
- When using slow synchronization in the **P**, **A** or **S** mode, the slowest available shutter speed varies depending on the ISO setting.



In some situations, you may get better results when the exposure that the camera sets is compensated (adjusted) manually. You can adjust the exposure by selecting the exposure compensation value. After adjusting the exposure, you can check the picture in the viewfinder or on the monitor.

Mode dial



1 Turn the control dial while holding down

- Adjust toward + Turn to the right to adjust up to +2.0.
- Adjust toward – Turn to the left to adjust up to –2.0.
- The exposure compensation can be set in 1/3EV steps or 1/2EV steps. “EV STEP – Setting exposure adjustment increments” (P.153)

Control dial
Exposure compensation button

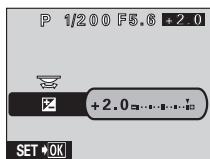
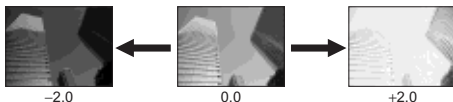
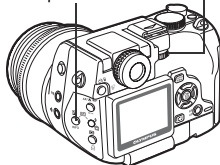

TIPS

- Often bright subjects (such as snow) will turn out darker than their natural colors. Adjusting toward + makes these subjects closer to their real shades. For the same reason, adjust toward – when shooting dark subjects.
- Pressing when histogram is set to ON displays the histogram in the viewfinder or on the monitor.
- If you press while pressing , the menu for changing the histogram setting is displayed. “Histogram – Displaying the luminance distribution of still pictures” (P.119)
- You can change the position of the histogram target mark. “Changing the position of the histogram target mark” (P.120)



Note

- You can set the aperture by turning the control dial while holding down in **M** mode. “Manual shooting” (P.72)
- If the flash is used, the image brightness (exposure) may differ from the intended brightness.
- Exposure compensation cannot correct the image if the surroundings of the subject are extremely bright or dark.





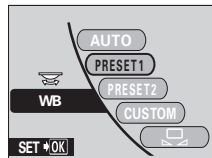
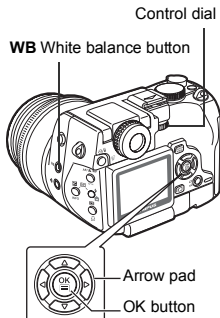

Color reproduction differs depending on the light conditions. For instance, when daylight, the setting sun or tungsten lighting are reflected on white paper, the shade of white produced will be slightly different for each. By setting the WB (white balance), you can achieve more natural-looking colors.

Mode dial





- 1 Turn the control dial while holding down **WB**, then select the best white balance (**AUTO**, **PRESET1**, **PRESET2**, **CUSTOM**, ) for the shooting conditions.



- 2 If you selected **PRESET1**, **PRESET2**, **CUSTOM** or , press  while holding down **WB** to display the next selection screen.
 - PRESET1**  "Preset1 white balance" (P.110)
 - PRESET2**  "Preset2 white balance" (P.110)
 - CUSTOM**  "Custom white balance" (P.111)
 -   "One-touch white balance" (P.111)

Auto white balance

Automatically adjusts the white balance for any light source.

- Press  while holding down **WB** to display the menu for adjusting and storing the auto white balance.
 -  "White balance compensation" (P.112)
 -  "Saving a custom white balance" (P.113)

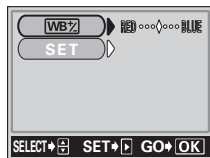

Preset1 white balance

Select a white balance setting according to the type of light when shooting outdoors.

- 1 Press to select **PRESET1**, then press .
- 2 Press to select , , or , then press .
 - Press again to exit the menu.

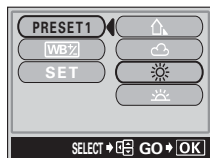

- For shooting in the shade
- For shooting on a cloudy day
- For shooting on a sunny day
- For shooting in evening sunlight

Preset2 white balance

Select a white balance setting according to the type of light when shooting indoors.

- 1 Press to select **PRESET2**, then press .
- 2 Press to select , , , , , depending on the type of light, then press .
 - Press again to exit the menu.

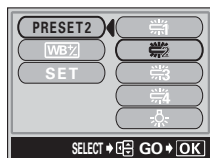

- For shooting under a daylight fluorescent lamp (6,700K)*. This type of lamp is used mainly in homes.
- For shooting under a neutral white fluorescent lamp (5,000K)*. This type of lamp is generally used in desk lamps, etc.
- For shooting under a cool white fluorescent lamp (4,200K)*. This type of lamp is generally used in offices, etc.
- For shooting under a white fluorescent lamp (3,500K)*.
- For shooting under a tungsten light (3,000K)*.

* The color temperature values (K) are approximate. They are NOT an accurate indication of color.

Custom white balance

Storing the white balance and white balance compensation settings lets you reactivate the settings for use later on. "Saving a custom white balance" (P.113)

1 Press to select CUSTOM 1, CUSTOM 2, CUSTOM 3 or CUSTOM 4, then press .

- Press again to exit the menu.
- Custom1 is set to sunny day light condition.
- If no custom white balance has been saved, this item cannot be selected.

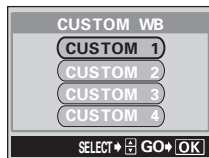

One-touch white balance



This function is useful when you need more precise white balance than PRESET WB can provide. To set the optimum white balance for the shooting conditions, point the camera at a white object under the light source you want to use and adjust the white balance.

1 Press to select GO, then press .

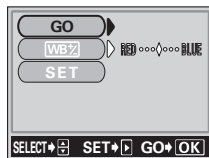

2 Display the screen and point the camera at a sheet of white paper.

- Position the paper so that it fills the screen, making sure there are no shadows.



3 Press .

- The new white balance is set.



One-touch white balance

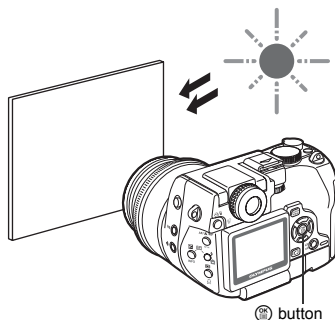



Note

- When setting the white balance by pointing the camera at a sheet of white paper, the correct setting may not be obtained if the light reflected by the paper is too bright or too dark.
- White balance may not be effective under some special light sources.
- After setting a white balance other than AUTO, play back the picture and check the colors on the monitor.
- When the flash is fired with a white balance setting other than AUTO, colors may appear different in the resulting picture from the colors you see on the monitor.

White balance compensation



This function lets you make fine changes to the AUTO, PRESET 1, PRESET 2 and one-touch white balance settings.



- 1 Follow the procedure on P.109 - P.111 to select the white balance you want to adjust.

WB White balance button



- 2 Press while holding down WB.
- 3 Press to select , then press .

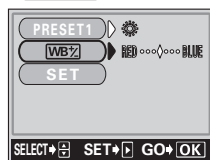

- 4 The color becomes bluer each time you press , and redder each time you press , depending on the original white balance conditions. Press to save your adjustment.

- The white balance can be adjusted 7 increments in both the red and blue directions.
- After saving the adjustment, press again to exit the menu.



Saving a custom white balance

You can save the current white balance setting and white balance compensation value in CUSTOM 1 to CUSTOM 4 and select them as custom white balance menus.



- 1 Follow the procedure on P.109 - P.111 to select the white balance you want to save.

WB White balance button

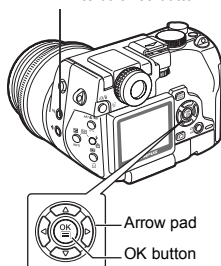

- 2 Press while holding down WB.
- 3 Press to select SET, then press .

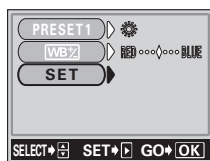

- 4 Press to select CUSTOM 1, CUSTOM 2, CUSTOM 3 or CUSTOM 4, then press .
 - The current white balance setting and white balance adjustment value are saved as a custom white balance.
 - If a custom white balance is already saved in the selected number, a confirmation screen appears. To register the new settings, select RESET and press .
 - Press again to exit the menu.

This function adjusts the sharpness of the image.



Mode dial





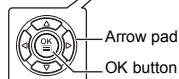
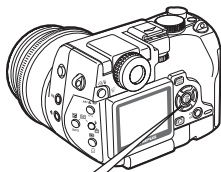

- 1 In the top menu, select **MODE MENU** → **PICTURE** → **SHARPNESS**, and press .

 "Menu basics" (P.38)



- 2 Press   to adjust the sharpness between **+5** and **-5**.

- To increase the sharpness (+) :
Press . The image contours are emphasized, making the image appear sharper and more vivid. Use this setting when you want to print pictures.
- To reduce the sharpness (-) :
Press . The image contours are softened. Use this setting when you want to edit images on a PC.
- When you have finished setting the sharpness, press . Press  again to exit the menu.

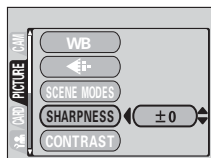

- If you adjust the sharpness too far toward +, noise may become noticeable in the picture.



This function adjusts the contrast of the image. For example, you can make images with marked differences in light and shadow softer, and those with less differences more vivid.



- 1 In the top menu, select **MODE MENU** → **PICTURE** → **CONTRAST**, and press .

"Menu basics" (P.38)

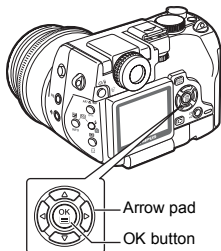

- 2 Press to adjust the contrast between **+5** and **-5**.

- To increase the contrast (+):
Press . The light and dark areas are defined more clearly, making the image look crisper.
- To reduce the contrast (-):
Press . The light and dark areas become less defined, giving the image a softer impression. Use this setting when you want to edit images on a PC.
- When you have finished setting the contrast, press . Press again to exit the menu.

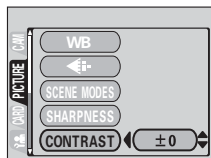

This function adjusts the tint of the whole picture. The hue can be adjusted between +5 and -5.

Mode dial



- 1 In the top menu, select **MODE MENU** → **PICTURE** → **HUE**, and press

"Menu basics" (P.38)

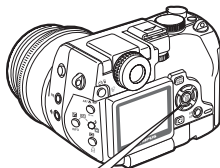

- 2 Press to adjust the hue between +5 and -5.

- To increase the hue (+) :
Press . Based on the blue of the sky, the pictures takes on a purpler hue.
- To reduce the hue (-) :
Press . Based on the blue of the sky, the picture takes on a greener hue.



- When you have finished setting the hue, press . Press again to exit the menu.

This function adjusts the color depth.

Mode dial



- 1 In the top menu, select **MODE MENU** → **PICTURE** → **SATURATION**, and press .

“Menu basics” (P.38)

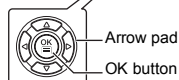
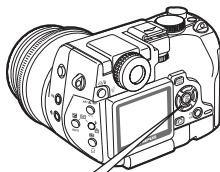

- 2 Press to adjust the saturation between +5 and -5.

- To increase the saturation (+):
Press . Colors become darker and more intense.
- To reduce the saturation (-):
Press . Colors become lighter.
- When you have finished setting the saturation, press . Press again to exit the menu.

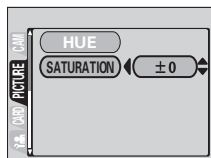

SCENE MODES

In **P**, **A**, **S**, **M**, and modes, the image is processed according to your purpose and the effect you want to achieve. The color reproduction, sharpness, contrast and saturation are adjusted automatically.

Mode dial



- 1 In the top menu, select **MODE MENU** → **PICTURE** → **SCENE MODES**, then choose from → **NORMAL**, , or , and press .

“Menu basics” (P.38)

- For , and modes, see “Situation-related modes” (P.49).
- Press again to exit the menu.

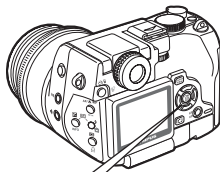

This function reduces the noise that is generated during long exposures. When shooting night scenes, shutter speeds become slower and noise tends to appear on images. When noise reduction is set to ON, the camera automatically reduces noise to produce clearer images. However, shooting time is approximately twice as long as usual.

Noise reduction can only be used when the shutter speed is set slower than 1/2 sec.



Noise reduction: OFF



Noise reduction: ON

The purpose of these pictures is to illustrate the effects of noise reduction. They are not actual pictures.

Mode dial

P A S M

- In the top menu, select **MODE MENU** → **CAMERA** → **NOISE REDUCTION** → **ON** or **OFF**, and press .

"Menu basics" (P.38)

- Press again to exit the menu.

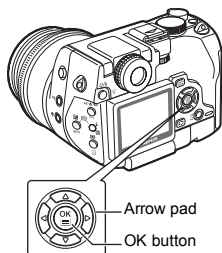

Note

- When mode is set, noise reduction is fixed to ON.
- When noise reduction is set to ON, the camera implements noise-reducing processes after each shot. For this reason, shooting time is approximately twice as long as usual. During this time, you cannot continue shooting.
- When noise reduction is set to ON, sequential shooting (**HI** , , **AF** , **BKT**) is not possible.
- This function may not work effectively with some shooting conditions or subjects.
- As the shutter speed is relatively slow, the use of a tripod is recommended.

Histogram – Displaying the luminance distribution of still pictures



During still picture shooting, you can display a histogram showing the brightness and contrast of your subject in the viewfinder or on the monitor. You can also display the black and white areas directly on the image. Checking the histogram during shooting enables precise exposure control.

- OFF** The histogram is not displayed.
- ON** The histogram is displayed when is pressed.
 "Exposure compensation" (P.108)
- ON** The histogram is always displayed.
- DIRECT** The black and white areas are displayed directly on the image.

Ex. When **ON** is selected in **P** mode
When the image is bright

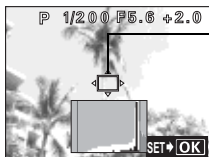

Histogram target mark

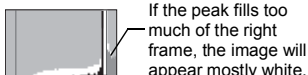

If the peak fills too much of the right frame, the image will appear mostly white.

When the image is dark



If the peak fills too much of the left frame, the image will appear mostly black.

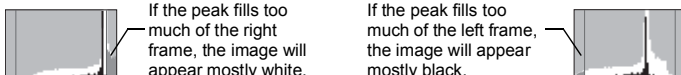

The part indicated in green in the histogram shows the luminance distribution within the histogram target mark.

Ex. When **DIRECT** is selected in **P** mode

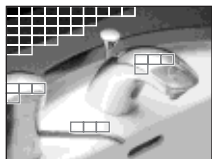

Red frame: Mostly white area
Blue frame: Mostly black area

If the area contains both black and white parts, it is also displayed in the blue frame.

Mode dial



1 Press while holding down .

Exposure compensation button

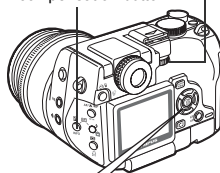

2 Press to choose the histogram display mode, then press .

- In **M** mode, when histogram is not set to OFF, the subject is displayed in the viewfinder or on the monitor at the appropriate brightness for the selected exposure.

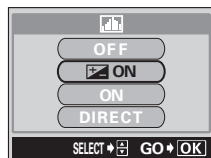

Note

- The histogram or the direct is not displayed in the following situations even if is set to ON or DIRECT.

During panorama shooting or during multi-metering

- You can turn the histogram display on and off during exposure compensation. “Exposure compensation” (P.108)
- The histogram displayed during shooting may differ from that displayed during playback.
- The histogram is not displayed in movie mode.

● Changing the position of the histogram target mark

While the histogram is displayed in shooting mode, hold down and use the arrow pad to move the histogram target mark. The area inside the target is displayed in green on the histogram.

To restore the histogram target mark to its original position, press while holding down .

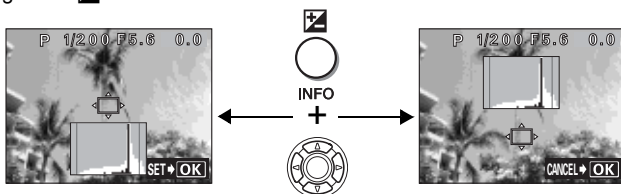

7 Playback

Viewing still pictures



Mode dial



1 Set the mode dial to (playback mode) and turn the camera on.

 "Turning the power on/off" (P.25)

- The last picture taken is displayed. (Single-frame playback)
- Shooting information is displayed for about 3 seconds. You can change how much information is displayed on the screen.

 "INFO – Displaying shooting information" (P.135)

- For details of the information displayed, see "Viewfinder and monitor indications" (P.11).

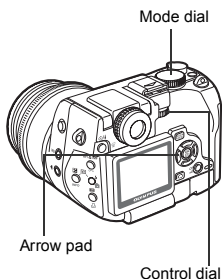

2 Use the arrow pad or control dial to play back other pictures.

- **Arrow pad**

Jumps to the picture 10 frames back.

Displays the previous picture.

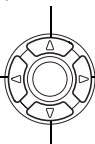

Displays the next picture.

Jumps to the picture 10 frames ahead.

- **Control dial**

Displays the previous picture.



Displays the next picture.



Note

- If no operation is performed for about 3 minutes, the camera automatically enters the sleep mode and the monitor or viewfinder turns off. Press  or any button to turn the monitor or viewfinder on.

QUICK VIEW

This function lets you play back pictures while the camera is in the shooting mode. This is useful when you want to check shooting results and resume shooting quickly.

Functions available in normal playback mode are also available in Quick View.



1 Press the QUICK VIEW button in the shooting mode.

- The camera immediately enters the playback mode and displays the last picture taken. (Single-frame playback)

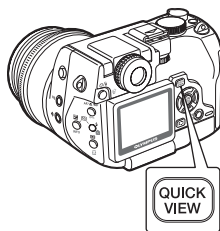

2 Press the QUICK VIEW button again to return to the shooting mode.

- A light press of the shutter button will also return the camera to shooting mode.

Picture rotation



Pictures taken with the camera held vertically are displayed horizontally. This function lets you turn such pictures 90 degrees clockwise or counterclockwise so that they are displayed vertically.

Mode dial



1 In the single-frame playback mode, press .

- Each pressing of rotates the image in the following sequence: 90 degrees counterclockwise, 90 degrees clockwise, and back to the original.

Rotation button

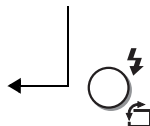
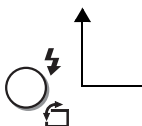
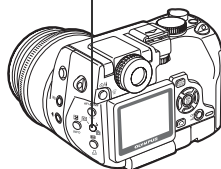

- The following pictures cannot be rotated.
Movies, protected pictures, pictures that have been edited on a PC and pictures taken with another camera
- New picture orientations are saved even when the power is turned off.



Pictures displayed on the monitor can be enlarged 2, 3, 4 or 5 times.

Mode dial



1 Select the still picture you want to enlarge.

- You cannot enlarge pictures with .

2 Turn the zoom lever toward T (Q).

- The picture is enlarged in steps each time the lever is turned.
- By using the arrow pad while the enlarged picture is displayed, you can shift the picture in the desired direction, enabling you to view a different portion.
- Turning the control dial allows you to view the next or previous frame in the same magnification.
- To return the picture to the original size (1x), turn the zoom lever toward W.

Zoom lever

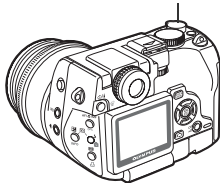

7

Playback

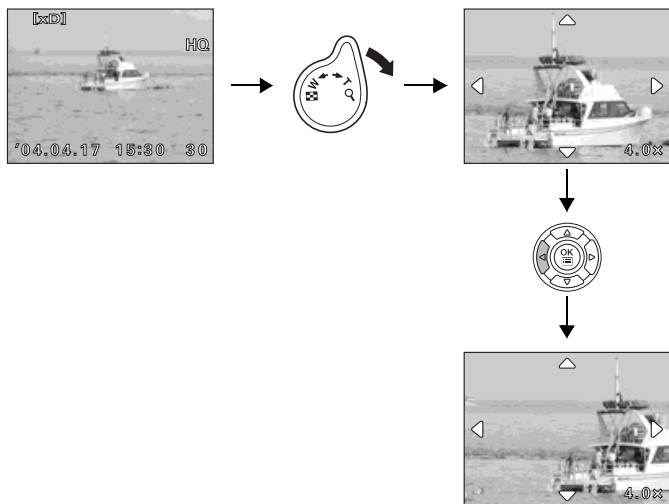

The left side of the picture is displayed.



- Pictures cannot be stored in an enlarged state.

Note



This function lets you show several pictures at the same time on the monitor. The number of pictures shown can be 4, 9 or 16. "Selecting the number of pictures" (P.126)

Mode dial



- 1 In the single-frame playback mode, turn the zoom lever toward W

Zoom lever

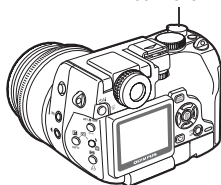

- Use the arrow pad to select the picture.

: Moves to the previous frame.

: Moves to the next frame.

: Moves to the upper frame.

: Moves to the lower frame.

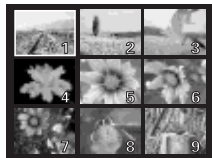

- Turning the control dial during an index display allows you to change the pages displayed.

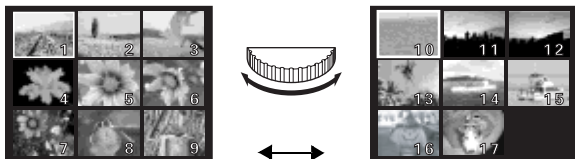

- To return to the single-frame playback, turn the zoom lever toward T.

Selecting the number of pictures

This function lets you select the number of pictures in an index display from 4, 9 and 16.

Mode dial



1 In the top menu, select MODE MENU →

→ → 4, 9 or 16, and press .

"Menu basics" (P.38)

- Press again to exit the menu.

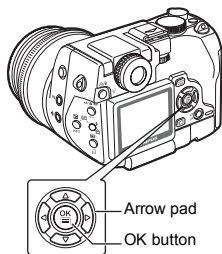

TIPS

- Pictures can also be displayed in index format using the tab in SET UP mode.



This function displays still pictures stored in the card one after another. Only the first frame of a movie is played back.

Mode dial



- 1 Select a still picture, then press to display the top menu.

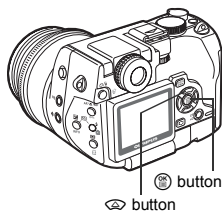

- 2 Press to start the slideshow.

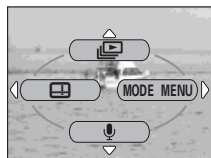

- 3 Press to stop the slideshow.

- The slideshow will not stop until you cancel it by pressing .



Note

- You are recommended to use the optional AC adapter when running a slideshow for a long period of time. If a battery is used, the camera will stop the slideshow after about 30 minutes and enter sleep mode.



This function lets you play back movies. You can fast forward the movie, play it back one frame at a time or save selected frames as still pictures (capture, SHQ only).

Mode dial



- 1 Use the arrow pad or control dial to display the picture with you want to play back.

"Viewing still pictures" (P.121)

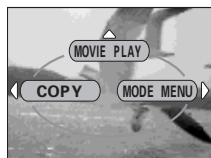
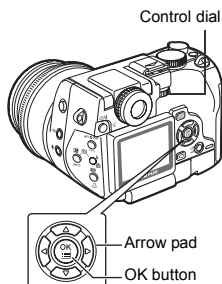

Playing time/Total recording time

- 2 Press .
 - The top menu is displayed.
- 3 Press to select MOVIE PLAY.
- 4 Press to select MOVIE PLAYBACK, then press .

● The following operations can be performed during movie playback.

appears on movies that have sound recorded. Pressing

lets you adjust the sound volume during playback.

: Increases the volume.

: Reduces the volume.

: Plays the movie at double the normal speed. Holding the button down increases the speed to 20 times the normal speed.

: Plays the movie in reverse at double the normal speed. Holding the button down increases the speed to 20 times the normal speed.

: Pauses playback and displays the MOVIE PLAYBACK menu.

5 Press .





- The MOVIE PLAYBACK menu is displayed.

PLAYBACK	Plays back the entire movie again.
FRAME BY FRAME	Plays back the movie manually one frame at a time.
CAPTURE	Cuts one frame from the movie and saves it as a still picture. If the movie is recorded in the record mode other than SHQ, this cannot be selected.
EXIT	Leaves the movie playback mode.













6 Press to select **PLAYBACK, FRAME BY FRAME, CAPTURE or EXIT**, then press .

● If you selected **FRAME BY FRAME**

-  : Displays the first frame of the movie.
-  : Displays the last frame of the movie.
-  : Displays the next frame. The movie can be played continuously by holding the button down.
-  : Displays the previous frame. The movie can be played continuously in reverse by holding the button down.
-  : Displays the MOVIE PLAYBACK menu.



● If you selected **CAPTURE**

- Play back the movie one frame at a time until the frame you want to save as a still picture is displayed.**
- Press .**
- Press   to select **CAPTURE**, then press .**
- Press   to select the card, then press .**
 - If only one card is inserted, skip this step.
 - When there is insufficient card memory, the display returns to the MOVIE PLAYBACK menu.
- Press   to select **OK**, then press .**
 - A still picture is created from the extracted movie frame and the display returns to the MOVIE PLAYBACK menu.



TIPS

- Movies can also be played back in the shooting mode using QUICK VIEW.  "QUICK VIEW" (P.122)



Note

- The still picture created in CAPTURE is SQ2 (640 × 480 pixels). This picture may be grainier than still pictures of the same size.
- While the card access lamp is blinking, the camera is reading the movie from the card. Reading of movies may take considerable time. Do not open the card cover while the card access lamp is blinking as this may cause not only the data on the card to be damaged, but may also render the card unusable.

Editing movies

This function lets you create indexes from as well as edit movies. However, you cannot edit movies longer than approximately 56 seconds in SHQ mode, 150 seconds in HQ mode and 600 seconds in SQ mode.

INDEX 9 frames extracted from a movie are displayed as an index to show the movie at a glance. Indexes can be stored on the card as still pictures.

EDIT This function lets you cut the parts of the movie that you want and edit.

7

Playback

Mode dial



1 Use the arrow pad to select a picture with .

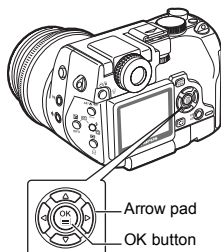

2 In the top menu, select **MOVIE PLAY**, then choose each item.

 "Menu basics" (P.38)

Select "INDEX"

 P.131

Select "EDIT"

 P.132

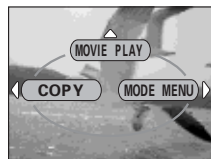

Creating an index

3 Press to select INDEX, then press .



4 Select the first frame of the index with the arrow pad and press .

- : Jumps to the first frame of the movie.
- : Jumps to the last frame of the movie.
- : Displays the next frame. The movie can be played continuously by holding the button down.
- : Displays the previous frame. The movie can be played continuously in reverse by holding the button down.



5 As in Step 4, select the last frame of the index with the arrow pad and press .



6 Press to select the card, then press .

- If only one card is inserted, skip this step.
- When there is insufficient card memory, the display returns to the setting screen.

7 Press to select OK, then press .

- The camera returns to the playback mode, then the 9 frames extracted from the movie appear as an index display. The index is stored as a new picture.
- If you want to select different frames, select RESET and press and repeat the procedure from Step 4.
- To quit the index function, select CANCEL and press .



TIPS
 • The index is stored as a still picture in a different record mode from the original movie.

Record mode when the movie was shot	Record mode when stored as an index
SHQ	SQ1 (2048 × 1536 pixels: HIGH)
HQ	SQ2 (1024 × 768 pixels: HIGH)
SQ	SQ2 (640 × 480 pixels: HIGH)



Note

- The interval between the frames that are automatically picked out varies depending on the length of the movie.
- An index consists of 9 frames.
- You cannot create an index if there is insufficient memory space on the card.

Editing a movie

3 Press to select EDIT, then press .



4 Select the first frame of the part you want to keep with the arrow pad and press .

- : Jumps to the first frame of the movie.
- : Jumps to the last frame of the movie.
- : Displays the next frame. The movie can be played continuously by holding the button down.
- : Displays the previous frame. The movie can be played continuously in reverse by holding the button down.



5 As in Step 4, select the last frame of the part you want to keep and press .



6 Press to select the card, then press .

- If only one card is inserted, skip this step.
- When there is insufficient card memory, the display returns to the setting screen.

7 Press to select NEW FILE or OVERWRITE, then press .



NEW FILE Stores the edited movie as a new movie.

OVERWRITE Stores the edited movie with the same name as the original. The original movie is erased.

- If the card selected in Step 6 is different from the card on which the original movie is stored, skip this step.



8 Press to select OK, then press .

- If you want to select different frames, select RESET and press  and repeat the procedure from Step 4.
- To quit the editing function, select CANCEL and press .
- The edited movie is stored and the screen returns to the playback mode.



Note

- You cannot edit movies with sound which were taken with another digital camera.
- You cannot select NEW FILE if there is insufficient memory space on the card.

Playback on TV

Use the AV cable provided with the camera to play back recorded images on your TV. Both still pictures and movies can be played back.

Mode dial



- 1 Make sure that the TV and camera are turned off. Connect the A/V OUT jack on the camera to the video input terminal on the TV using the AV cable.**

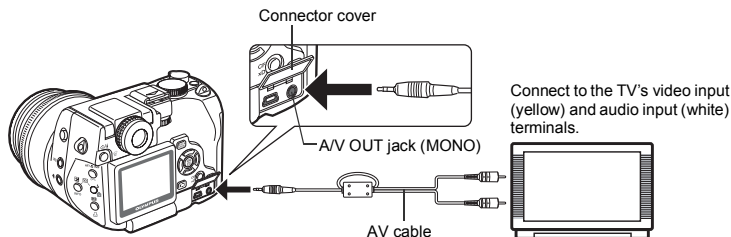

- 2 Turn the TV on and set it to the video input mode.**

- For details of switching to video input, refer to your TV's instruction manual.

- 3 Set the mode dial to  and turn the camera on.**

- The last picture taken is displayed on the TV. Use the arrow pad to select the picture you want to display.
- The close-up playback, index display, slideshow and other playback functions can also be used on a TV screen.



TIPS

- You are recommended to use the optional AC adapter when using the camera with a TV.



Note

- Make sure that the camera's video output signal type is the same as the TV's video signal type.
 - ➡ "VIDEO OUT – Setting the video signal type" (P.174)
- The camera's monitor and viewfinder turn off automatically when the AV cable is connected to the camera.
- Be sure to use the AV cable provided to connect the camera to the TV.
- The picture may appear off-center on the TV screen.
- When pictures are compressed in order to fit the entire picture on the TV screen, a black frame may appear around the picture. If the picture is output to a video printer via the TV, the black frame may be printed.

This function lets you display shooting information or a histogram in the single-frame playback mode.

- OFF** Displays the only basic informations, such as the record mode, date and time, and number of frames.
- ON** Displays detailed shooting information on the monitor for 3 seconds. For details of the information displayed, see “Viewfinder and monitor indications” (P.11).
- Histogram** Displays a histogram showing the brightness and contrast of still pictures. For more details, see “Histogram – Displaying the luminance distribution of still pictures” (P.119).

Mode dial



1 Press INFO repeatedly.

- Each time you press **INFO**, the information displayed changes as follows.

INFO Information display button

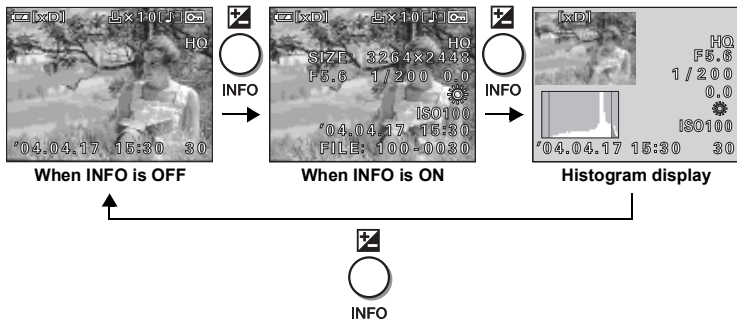
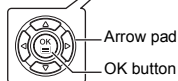
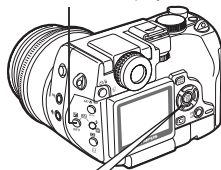

- If the picture has been taken with a different camera, not all the information may be displayed when INFO is set to ON.
- The file number used to specify an image when making non-DPOF print at a print shop is displayed when INFO is set to ON.
 “How to print pictures” (P.176)
- The histogram displayed during shooting may differ from that displayed during playback.
- The histogram is not displayed in movie.
- It may not be possible to display a histogram for pictures taken with another camera.



This function lets you display guidelines on the monitor during single-frame playback.

Mode dial



- 1 In the top menu, press .
 - The guidelines are displayed.

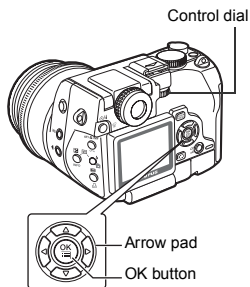

- 2 Press to select the type of guidelines.

- When the guidelines are displayed, use or the control dial to display the picture you want to see.

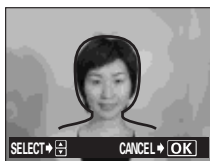

Horizontal position

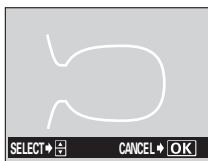

Vertical position

- 3 Press to remove the guidelines.

- The guidelines on the screen disappear and the camera returns to normal single-frame playback.



Note

- The guidelines are not displayed during close-up playback or during an index display.



Sound can be added to a still picture that you have already taken. (This is known as “after-recording”.) You can also re-record over the sound that has already been recorded. Total recording time per picture is approximately 4 seconds.

Mode dial



- 1 Select the still picture to which you want to add sound, then press to display the top menu.

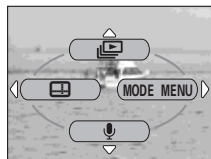
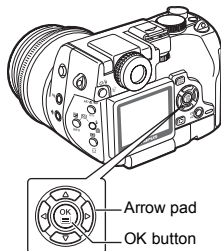

- 2 Press to display START.

- 3 Turn the camera microphone toward the sound you want to record and press to start recording.

- The **BUSY** bar is displayed during recording.

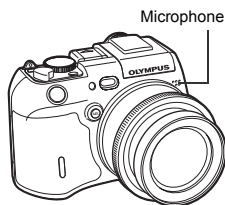

Note

- If the microphone is placed farther than 1m (3.3ft) away from the subject, the recorded sound quality may not be satisfying.
- If you re-record the sound, the original sound is erased.
- You may not be able to record sound when there is insufficient card memory (the CARD FULL message is displayed).
- Sound recording may pick up camera noises, such as button operation or shutter movement.
- Once sound is added to a picture, it is not possible to erase only the sound. In this case, make a re-recording with silence.

Editing still pictures

This function lets you edit still pictures and store them as new pictures. The following editing operations are possible.

Resizing

Changes the picture size to 640 × 480 or 320 × 240 and stores the picture as a new file.

Trimming

Crops part of a picture and saves it as a new file.

RAW DATA EDIT

Adjusts the white balance, sharpness, etc. of the pictures recorded in the RAW data format and stores them as new TIFF or JPEG files. You can edit recorded pictures to your liking while checking the result.

Mode dial

1 In the top menu, select **MODE MENU** → **EDIT**, then choose each item.

 “Menu basics” (P.38)

Select 

 P.138

Select 

 P.139

Select **RAW DATA EDIT**  P.140

When selecting RAW DATA EDIT, display the image recorded in RAW mode first.

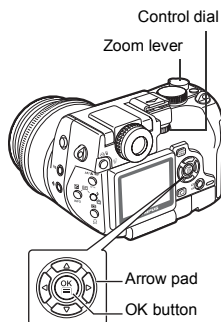

7

Playback

Resizing

2 Select , then press .

3 Turn the control dial to select the still picture you want to edit, then press .

4 Press to select a resolution, then press .

- To quit the resizing function, select CANCEL, then press .

5 Press to select the card, then press .

- If only one card is inserted, skip this step.
- When there is insufficient card memory, the display returns to the setting screen.

6 Press to select **OK**, then press .

- The **BUSY** bar is displayed during resizing. After the image is saved, the camera returns to Step 3.

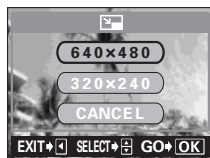













Note

- Resizing is not possible in the following cases.
 - Movies, pictures recorded in RAW data format, pictures that have been edited on a PC, or when there is insufficient memory space on the card.
 - If the size of the selected picture is 640×480 , you cannot select 640×480 .

Trimming



- Select , then press .
- Turn the control dial to select the still picture you want to edit, then press .
- Press   to select , then press .

- Use the arrow pad, zoom lever and control dial to decide the trimming position and size.
 - Press     to select the trimming frame, and turn the zoom lever toward W or T to decide the trimming size.
 - Use the control dial to select the height and width of the trimming frame.
 - 3:2 trimming size can be selected when the size of the selected picture is 3264×2448 or 3264×2176 .



- Press .

- The trimmed picture is displayed for one second.

- Press   to select the card, then press .

- If only one card is inserted, skip this step.
- When there is insufficient card memory, the display returns to the setting screen.

- Press   to select OK, then press .

- The **BUSY** bar is displayed during trimming. After the image is saved, the camera returns to Step 3.
- The trimmed picture is stored as a separate picture from the original.
- If you want to trim the picture again, select RESET and press . Then repeat the procedure from Step 5.
- To quit the trimming function, select CANCEL and press .



7

Playback



Note

- Trimming is not possible in the following cases.
 - Movies, pictures recorded in RAW data format, or when there is insufficient memory space on the card.
- It may not be possible to trim pictures taken with another camera.
- If a trimmed picture is printed out, it may appear grainy.

RAW editing

2 Select **RAW DATA EDIT**, then press

3 Turn the control dial to select the still picture you want to edit, then press

- You can only select an image recorded in RAW mode.

4 Press to select the item you want to set, then press .

5 Press to select the desired setting, then press .

6 When all the necessary items have been set, press .

7 Press to select the card, then press .

- If only one card is inserted, skip this step.
- When there is insufficient card memory, the display returns to the setting screen.

8 Press to select **OK**, then press .

- The **BUSY** bar is displayed during RAW editing. After the image is saved, the camera returns to Step 3.

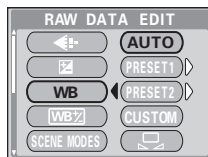
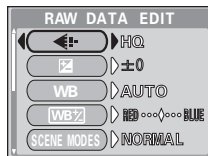

● Items that can be set by RAW editing

Item	Settings	Ref. page
	TIFF, SHQ, HQ, SQ1, SQ2	P.102
	±5 levels	P.108
WB	AUTO, PRESET1, PRESET2, CUSTOM*, *	P.109
	RED 7 to BLUE 7	P.112
SCENE MODES	NORMAL,	P.117
SHARPNESS	±5	P.114
CONTRAST	±5	P.115
HUE	±5	P.116
SATURATION	±5	P.117
FUNCTION	OFF, BLACK & WHITE, SEPIA	P.98
	—	P.139

* Can only be selected if WB was set to CUSTOM or during shooting.

Copying pictures

This function lets you copy pictures to and from the xD-Picture Card and CompactFlash or Microdrive. This menu can be selected if both cards are inserted.

The selected card is the copying source. You can change the copying source by pressing the card button. “Switching cards” (P.23)

ALL Copies all the pictures on the card.

SELECT Copies only the selected picture.

Mode dial



1 If you selected a still picture, in the top menu, select **MODE MENU** → **EDIT** → **COPY**, and press .

If you selected a movie, in the top menu, press to select **COPY**.

“Menu basics” (P.38)

- The screen is displayed for you to select **ALL** or **SELECT**.

2 Press to select **ALL** or **SELECT**, then press .

● If you choose **ALL**

A confirmation screen appears asking if you want to copy the pictures. Select **YES** and press .

- The pictures are copied and the menu is exited.

● If you choose **SELECT**

The playback screen is displayed. Turn the control dial to select the frame you want to copy and press .

- The picture is copied.
- If you want to copy more pictures, repeat the procedure.
- To finish copying, press . Press repeatedly until the menu disappears.

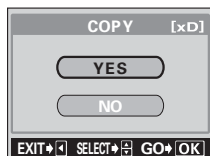
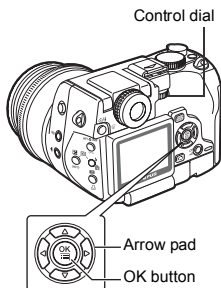



Note

- Pictures cannot be copied to the same card.
- Files with a volume of 57 MB or over (movies of over approximately 64 seconds in SHQ mode, 70 seconds in HQ mode or 685 seconds in SQ mode) cannot be copied. If you try to copy such files, the message "FILE SIZE SELECTED TOO LARGE" will be displayed.

Protecting pictures



You are recommended to protect important pictures to avoid accidentally erasing them. Protected pictures cannot be erased by the single-frame/all-frame erase function.

Mode dial



1 Use the arrow pad or control dial to display the picture you want to protect.

"Viewing still pictures" (P.121)

2 Press .

- To cancel protection, press again.

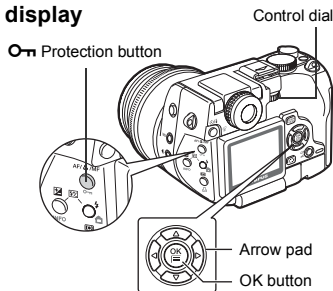

Displayed when a picture is protected.



Note

- Protected pictures cannot be erased by the single-frame/all-frame erase function, but they are all erased by formatting.



This function lets you erase recorded pictures. Single-frame erase erases only the picture displayed on the monitor and all-frame erase erases all the pictures on the card.



Note

- You cannot erase pictures that are protected. Cancel protection before erasing such pictures.
- Once erased, pictures cannot be restored. Check each picture before erasing to avoid accidentally erasing pictures you want to keep.
 "Protecting pictures" (P.142)

Single-frame erase



Mode dial



- 1 Use the arrow pad or control dial to display the picture you want to erase.

"Viewing still pictures" (P.121)

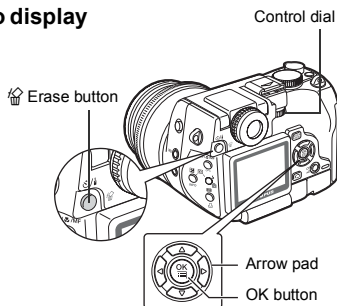

- 2 Press .

• The ERASE screen is displayed.

- 3 Press to select YES, then press .

• The picture is erased and the menu is closed.



All-frame erase



This function erases all the pictures on the card.

Mode dial



- In the top menu, select **MODE MENU** → **CARD** → **CARD SETUP**, and press .

"Menu basics" (P.38)
- Press to select **ALL ERASE**, then press .
- Press to select **YES**, then press .

 - All the pictures are erased.

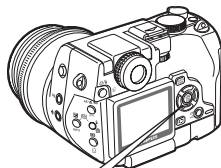

Arrow pad

OK button

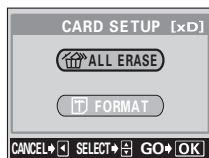

8 Customizing the camera

ALL RESET – Saving the camera's settings

This function lets you keep the current camera settings when you turn off the power. The same settings are then reactivated next time you turn the camera on. The settings affected by All Reset are listed on the next page.

The All Reset setting (ON/OFF) applies to all the modes. If All Reset is set in one mode, this setting applies to all the other modes, both shooting and playback.

ON All settings are returned to the factory default settings after the power is turned off.

Ex. If the record mode is changed to SQ1 and All Reset is set to ON, the record mode will return to HQ (factory default setting) next time the camera is turned on.

OFF The settings made before the power is turned off are saved and are activated again next time the camera is turned on.



- 1 In the top menu, select **MODE MENU** → → **ALL RESET** → **ON** or **OFF**, and press .
Or in **SET UP** mode, select → **ALL RESET** → **ON** or **OFF**, and press .

“Menu basics” (P.38)



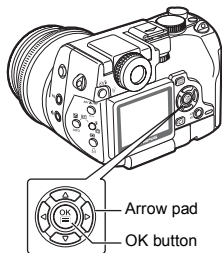















- Press again to exit the menu.
- In **SET UP** mode, set the mode dial to a different mode to exit the menu.



Note

- My Mode settings and functions on the SETUP tab (ALL RESET,) are not returned to the factory default settings even when All Reset is set to ON.
- When ALL RESET is set to OFF, it may take time to start up when the power is turned on.

● Functions that All Reset affects

Function	Factory default setting	Ref. page	Function	Factory default setting	Ref. page
FNo	F2.4	P.70	AF MODE	iESP	P.74
SHUTTER	1/1000	P.71	P-AF	ON	P.76
Program Shift	Reset	P.46	 (still pictures)	OFF	P.100
	0.0	P.108	 (movies)	ON	P.101
FLASH	AUTO	P.59	FUNCTION	OFF	P.95, 97, 98
	0.0	P.64		OFF	P.99
AF/  /MF	AF	P.79, 87, 88		OFF	P.119
	ESP	P.81		HQ	P.102
	OFF	P.89, 90	WB	AUTO	P.109
LCD/EVF	LCD (ON)	P.50		No compensation	P.112
CARD	xD	P.23	SCENE MODES	NORMAL	P.117
Optical zoom	wide	P.57	SHARPNESS	±0	P.114
		P.92	CONTRAST	±0	P.115
BKT	±1.0, 3 pictures	P.93	HUE	±0	P.116
ISO	AUTO	P.107	SATURATION	±0	P.117
MY MODE	MY MODE 1	P.73	JPEG DUPLICATE SETTING	OFF	P.106
 FLASH	IN+ 	P.66	TIFF, SHQ, HQ	3264 × 2448	P.105
SLAVE	1	P.69	SQ1	2048 × 1536 NORMAL	P.105
 SLOW	 SLOW1	P.63	SQ2	640 × 480 NORMAL	P.105
NOISE REDUCTION	OFF	P.118	INFO	OFF	P.135
DIGITAL ZOOM	OFF	P.58		640 × 480	P.138
FULLTIME AF	OFF	P.75			

REC VIEW – Checking the picture immediately after shooting

You can display the picture you have just taken on the monitor while it is being recorded to the card. This is useful for making a brief check of the picture you have just taken.

- OFF** The picture being recorded to the card is not displayed. This is useful when you want to prepare for your next shot while the previous picture is being recorded.
- AUTO** The picture you have just taken is displayed while it is recorded to the card.
- 3 SEC, 5 SEC, 10 SEC** You can select the length of time the picture is displayed. If recording is not completed in the set time, the picture is displayed until recording is finished.



1 In the top menu, select **MODE MENU** → **REC VIEW** → **OFF, AUTO, 3 SEC, 5 SEC or 10 SEC**, and press **OK**.

Or in **SET UP** mode, select **REC VIEW** → **OFF, AUTO, 3 SEC, 5 SEC or 10 SEC**, and press **OK**.

🔗 “Menu basics” (P.38)

- Press **OK** again to exit the menu.
- In **SET UP** mode, set the mode dial to a different mode to exit the menu.

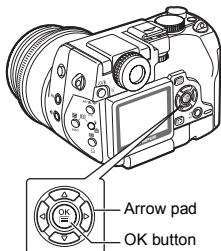

Setting the button operation sound **BEEP**

You can choose from 2 different sounds for button operations. You can also set the volume of each sound to LOW or HIGH. The factory default settings are 1 (short beep) for the sound and LOW for the volume. You can turn the sound off completely by setting OFF.



- 1** In the top menu, select **MODE MENU** → **PERSON** → **BEEP**, and press **OK**.
Or in **SET UP** mode, select **PERSON** → **BEEP**, and press **OK**.

☞ "Menu basics" (P.38)

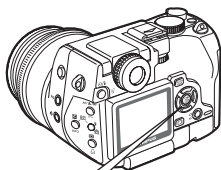

- 2** Select **1** or **2** and press **OK**. Then select **LOW** or **HIGH** and press **OK**.

- To turn the sound off completely, select OFF and press **OK**.
- Press **OK** again to exit the menu.
- In **SET UP** mode, set the mode dial to a different mode to exit the menu.

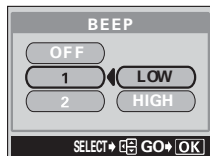

SHUTTER SOUND – Setting the shutter sound

You can select from 2 kinds of sounds for the shutter button. You can also set the volume of each sound to LOW or HIGH. The factory default settings are 1 for the sound and LOW for the volume. You can turn the sound off completely by setting OFF.

Mode dial

P

A

S

M



SET UP

1 In the top menu, select **MODE MENU** → → **SHUTTER SOUND**, and press .

Or in **SET UP** mode, select → **SHUTTER SOUND**, and press .

"Menu basics" (P.38)

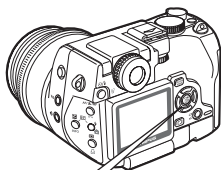

2 Select 1 or 2 and press . Then select **LOW** or **HIGH** and press .

- To turn the sound off completely, select OFF and press .
- Press again to exit the menu.
- In **SET UP** mode, set the mode dial to a different mode to exit the menu.

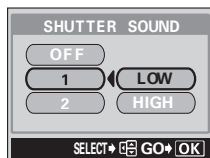



DIAL – Changing the function of the control dial



You can change the function of the control dial and arrow pad in the shooting mode. Normally, to adjust the exposure compensation, you turn the control dial while holding down , but this feature lets you set the exposure compensation using only the control dial.

In addition, it is also possible to set the functions by using both direct buttons and the control dial with only the direct buttons.

The function of the control dial and arrow pad varies depending on the shooting mode. You can also assign functions chosen from CUSTOM 1, CUSTOM 2 and CUSTOM 3. For more details, see the table on the next page.



1 In the top menu, select **MODE MENU** → 
→ **DIAL** → **NORMAL, CUSTOM 1, CUSTOM 2**
or **CUSTOM 3**, and press .







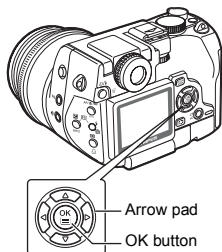















Or in **SET UP** mode, select  → **DIAL** →
NORMAL, CUSTOM 1, CUSTOM 2 or
CUSTOM 3, and press .

 "Menu basics" (P.38)



- Press  again to exit the menu.
- In **SET UP** mode, set the mode dial to a different mode to exit the menu.





● Control dial and arrow pad functions by shooting mode

Shooting mode	*	Function			
		NORMAL	CUSTOM 1	CUSTOM 2	CUSTOM 3
P   		—	Exposure compensation	Exposure compensation	—
		Program Shift	Program Shift	Program Shift	Program Shift
		—	—	—	Exposure compensation
A 		Aperture value	Exposure compensation	Exposure compensation	—
		—	Aperture value	—	Aperture value
		—	Exposure compensation	Aperture value	Exposure compensation
S 		Shutter speed	Exposure compensation	Exposure compensation	—
		—	Shutter speed	Shutter speed	Shutter speed
		—	Exposure compensation	—	Exposure compensation
M 		Shutter speed	—	—	—
		—	Shutter speed	Shutter speed	Shutter speed
		—	Aperture value	Aperture value	Aperture value
		—	Exposure compensation	Exposure compensation	—
		—	—	—	—
		—	Exposure compensation	—	Exposure compensation

*  : Turn the control dial to set.

 : Press   on the arrow pad to set.

 : Press   on the arrow pad to set.

Another CUSTOM 3 function

When CUSTOM 3 is selected, functions that were set by turning the control dial while holding down the direct button can be set using only the direct button. The setting can be changed by repeatedly pressing the direct button.

☞ “Functions that can be set using the direct buttons” (P.33)





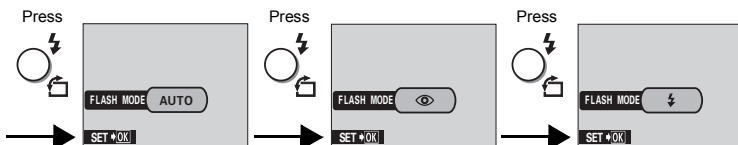

Ex. Changing the flash mode

Press  repeatedly.

- The flash mode changes each time  is pressed.



Precautions when using CUSTOM 3

- The exposure compensation cannot be adjusted by pressing . Flash intensity control cannot be adjusted by pressing  and  at the same time.
- When sharpness, contrast, hue or saturation are assigned to the  button, the setting cannot be changed by repeatedly pressing . PANORAMA and  cannot be selected when FUNCTION is assigned to the  button.

EV STEP – Setting exposure adjustment increments

You can set adjustment of the exposure compensation and flash intensity in 1/3EV or 1/2EV steps. The exposure compensation, flash intensity, shutter speed, aperture and ISO sensitivity will differ depending on the adjustment range you choose.



- 1 In the top menu, select **MODE MENU** → → **EV STEP** → 1/3EV or 1/2EV, and press . Or in **SET UP** mode, select → **EV STEP** → 1/3EV or 1/2EV, and press .

“Menu basics” (P.38)

- Press again to exit the menu.
- In **SET UP** mode, set the mode dial to a different mode to exit the menu.

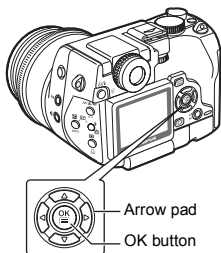

Custom button



You can set frequently used functions on the custom button. This makes it easy to jump to the SETUP screen without selecting MODE MENU or a shortcut menu in the top menu.

Selecting a setting with the control dial and pressing displays a dedicated screen for that setting. You can make fine settings using the arrow pad and .

Custom button

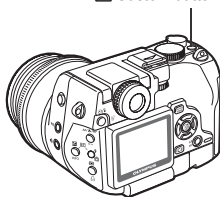

Functions that can be set on the custom button	Settings made by the control dial	Ref. page
ISO (default setting)	AUTO, 50 to 400	P.107
	HI, AF, BKT*	P.92
DIGITAL ZOOM	OFF, ON	P.58
NOISE REDUCTION	OFF, ON	P.118
FUNCTION	OFF, PANORAMA, , BLACK & WHITE, SEPIA	P.95, 97, 98
FRAME ASSIST	OFF, ON	P.99
(still pictures)	OFF, ON	P.100
(movies)	OFF, ON	P.101
MY MODE*	M1 to M8	P.73
	OFF, ON, ON, DIRECT	P.119
SCENE MODES	NORMAL, , ,	P.117
SHARPNESS	-5 to ± 0 to +5	P.114
CONTRAST	-5 to ± 0 to +5	P.115
HUE	-5 to ± 0 to +5	P.116
SATURATION	-5 to ± 0 to +5	P.117
*	-2.0 to ± 0 to +2.0	P.108
FLASH MODE*	AUTO, , , SLOW,	P.59
	-2.0 to ± 0 to +2.0	P.64
AF//MF	AF*, *, MF, s*, sMF	P.79, 87, 88
	ESP, , MULTI,	P.81
	OFF, , *	P.89, 90
WB*	AUTO, PRESET1, PRESET2, CUSTOM,	P.109
*	RAW, TIFF, SHQ, HQ, SQ1, SQ2	P.102

* The sub-menu lets you select further options.

Setting the custom button

Mode dial

P

A

S

M



SET UP

- In the top menu, select **MODE MENU** → **CUSTOM BUTTON**, and press .
Or in **SET UP** mode, select → **CUSTOM BUTTON**, and press .

“Menu basics” (P.38)

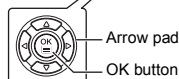
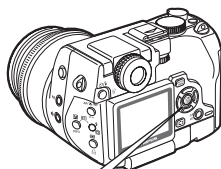

- Press to select the function you want to set, then press .

- Press again to exit the menu.
- In **SET UP** mode, set the mode dial to a different mode to exit the menu.

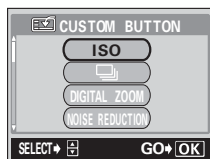

Note

- If the mode dial is set to a mode other than and is pressed when MY MODE is set on the custom button, the customized settings are not activated. Set the mode dial to and press to display the MY MODE screen.

Using the custom button



1 Press

- The function currently set to the custom button is displayed.

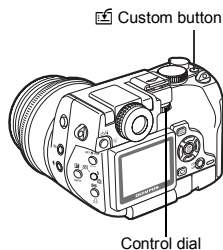

2 Turn the control dial while holding down to set.

- is used in the same way as the direct button. See "Direct button basics" (P.31)
- When an operation guide is displayed at the bottom of the screen, more specific settings can be made.

Ex.1: When is set to

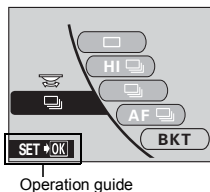

Ex.2: When SHARPNESS is set to



SHORT CUT

You can set three shortcut menus (A, B, C) in the top menu in a still picture shooting mode (P/A/S/M//////).

This is useful when you want to go quickly to frequently-used functions.

Direct button function is also possible to be set to shortcut.

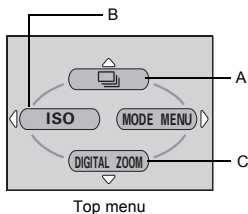

Default setting

A:

B: ISO

C: DIGITAL ZOOM

Functions that can be set in the shortcut menu	Ref. page	Functions that can be set in the shortcut menu	Ref. page
FLASH MODE	P.59	(still pictures)	P.100
AF//MF	P.79, 87, 88	MY MODE	P.73
ESP/	P.81		P.119
	P.92	WB	P.109
	P.89, 90		P.102
ISO	P.107	SCENE MODES	P.117
DIGITAL ZOOM	P.58	SHARPNESS	P.114
NOISE REDUCTION	P.118	CONTRAST	P.115
FUNCTION	P.95, 97, 98	HUE	P.116
FRAME ASSIST	P.99	SATURATION	P.117

Setting the shortcut menu

You can set the three shortcut menus designated by A, B and C on the diagram shown right.

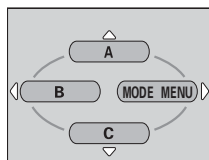

- 1 In the top menu, select **MODE MENU** → → **SHORT CUT**, and press .
Or in **SET UP** mode, select → **SHORT CUT**, and press .

“Menu basics” (P.38)

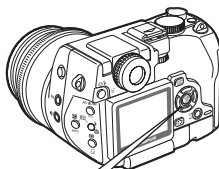

- 2 Press to select **A, B or C**, then press .

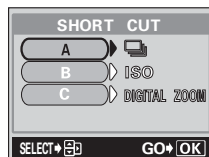

- 3 Press to select the function you want to set, then press .

- The shortcut menu is set.
- Press again to exit the menu.
- In **SET UP** mode, set the mode dial to a different mode to exit the menu.

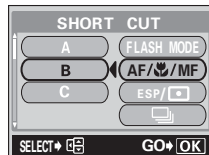

Using the shortcut menu

When you have set a shortcut menu, you can use it to jump to the setting screen for that function.



1 Press to display the top menu.

- The shortcut menu you have set appears on the top menu.

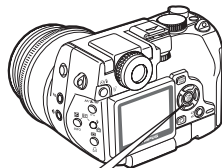

2 Press , or to select the shortcut menu.

- The monitor jumps directly to the setting screen for that function.

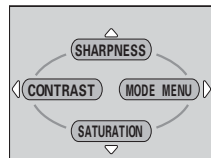

Ex. When SHARPNESS is set in shortcut menu A

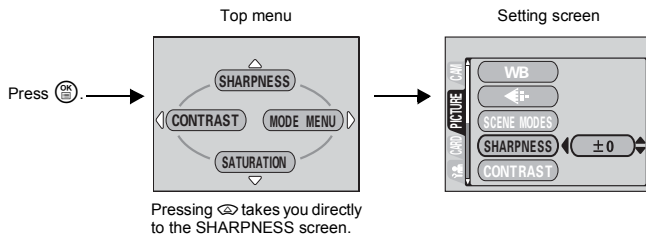















MY MODE SETUP – Setting a function in My Mode



You can set shooting-related functions in MY MODE. You can also save the current settings in MY MODE.

When the mode dial is set to , your customized settings are activated. You can save up to 8 different settings in MY MODE 1 to 8. Only MY MODE 1 has a factory default setting.

● Functions affected by MY MODE SETUP

Functions that can be set in MY MODE	Default setting	Ref. page	Functions that can be set in MY MODE	Default setting	Ref. page
P/A/S/M/S-Prg	P	P.46	WB	AUTO	P.109
FNo	F2.4	P.70		HQ	P.102
SHUTTER	1/1000	P.71			P.92
	0.0	P.108	ISO	AUTO	P.107
LCD/EVF*1	LCD	P.50	DIGITAL ZOOM	OFF	P.58
ZOOM*2	28 mm	–	NOISE REDUCTION	OFF	P.118
FLASH MODE	AUTO	P.59	FUNCTION	OFF	P.95, 97, 98
	0.0	P.64	FRAME ASSIST	OFF	P.99
 FLASH	IN+ 	P.66	 (still pictures)	OFF	P.100
 SLOW	 SLOW1	P.63		OFF	P.119
AF/  MF	AF	P.79, 87, 88	SCENE MODES	NORMAL	P.117
AF MODE	iESP	P.74	SHARPNESS	±0	P.114
FULLTIME AF	OFF	P.75	CONTRAST	±0	P.115
P-AF	ON	P.76	HUE	±0	P.116
ESP/ 	ESP	P.81	SATURATION	±0	P.117
 /i	OFF	P.89, 90			

*1 Sets whether the monitor (LCD) or viewfinder (EVF) turns on when the camera is turned on.

*2 In  mode, available zoom positions are 28 mm, 50 mm, 85 mm, 105 mm and 140 mm. (These numbers are based on the focal length of a 35 mm camera.)

Mode dial

P

A

S

M



SET UP

- 1 In the top menu, select **MODE MENU** → → **MY MODE SETUP**, and press .
Or in **SET UP** mode, select → **MY MODE SETUP**, and press .

"Menu basics" (P.38)

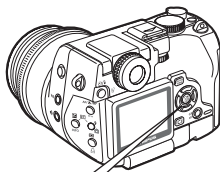

- 2 Press to select an item, then press .

CURRENT* Saves the current camera settings.

RESET Restores the factory default settings.

CUSTOM Saves settings one by one.

*Cannot be selected in **SET UP** mode.

- The MY MODE SETUP screen appears.

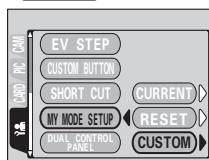

- 3 Select a **MY MODE** number.

- Press to select a MY MODE number from 1 to 8, then press .

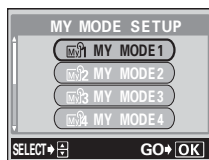

● When selecting **CURRENT** in Step 2

- 4 Press to select **SET**, then press .

- The current camera settings are saved in the selected MY MODE.

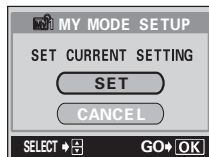

● When selecting RESET in Step 2

4 Press to select ALL RESET, then press .

- The settings in the selected MY MODE are reset. If no settings are saved, the relevant MY MODE number cannot be selected.

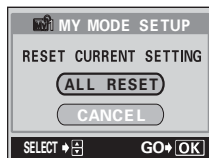

● When selecting CUSTOM in Step 2

4 Press to select the item you want to save in MY MODE, then press .

- For the available items, see “Functions affected by MY MODE SETUP” (P.160).

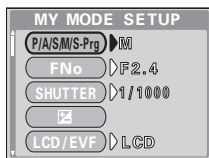

Press to change the setting, then press .

- The setting is saved.
- You can also change the other custom settings.

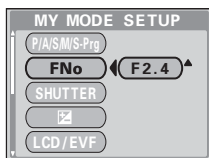

5 When you have made all the settings you want, press .

- The screen displayed in Step 2 appears.
- Press  again to exit the menu.
- In SET UP mode, set the mode dial to a different mode to exit the menu.



Note



- The zoom position is set to one of the five zoom positions available in MY MODE SETUP. The value closest to the current zoom position will be selected.

CONTROL PANEL – Using the monitor as a control panel



This option lets you display the each setting on the monitor in the shooting mode. The subject is displayed on the viewfinder.

Mode dial

P A S M        SET UP

- 1 In the top menu, select **MODE MENU** →  → **CONTROL PANEL** → ON, and press . Or in **SET UP** mode, select  → **CONTROL PANEL** → ON, and press .

 “Menu basics” (P.38)

- Press  again to exit the menu.
- In **SET UP** mode, set the mode dial to a different mode to exit the menu.
- The control panel is displayed on the monitor.
- Even when the control panel is displayed on the monitor, you can display the subject by pressing .
- Pressing the direct button displays the setting in green on the control panel. Each setting can be made on the control panel by turning the control dial.
- For more details  “Control panel screen” (P.164)

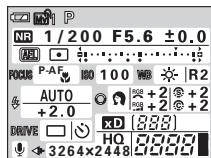
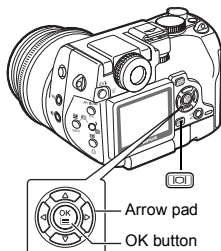

- The subject is displayed on the monitor when using functions that use the monitor, such as guideline shooting or panorama mode.

● Control panel screen

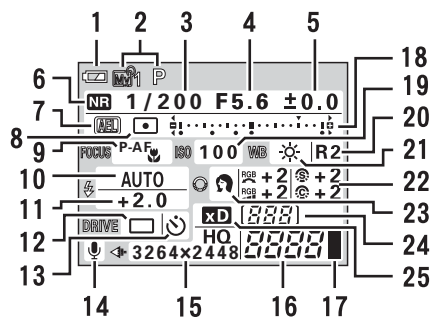

1	Battery check
2	Shooting mode
3	Shutter speed
4	Aperture value
5	Exposure compensation
6	Noise reduction
7	AE lock/AE memory
8	Spot metering/Multi-metering Center-weighted metering
9	Focus mode, P-AF
10	Flash mode
11	Flash intensity control
12	Sequential shooting
13	Self-timer/Remote control

14	Sound record
15	Record mode/Resolution
16	Number of storable still pictures/ Recording time
17	Memory gauge
18	Exposure compensation
19	ISO
20	White balance compensation
21	White balance
22	Saturation/Sharpness/Hue/ Contrast
23	Scene modes
24	Folder number
25	Selected card

VOLUME – Adjusting the playback volume

You can adjust the volume of the sound when playing back a still picture or movie. There are 5 levels to choose from.

Mode dial



SET UP

- 1 In the top menu, select **MODE MENU** → → **VOLUME**, and press .
Or in **SET UP** mode, select → → **VOLUME**, and press .

“Menu basics” (P.38)

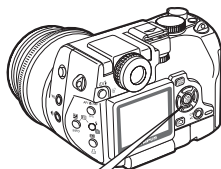

- 2 Press to select the volume level, then press .
- Press again to exit the menu.
 - In **SET UP** mode, set the mode dial to a different mode to exit the menu.

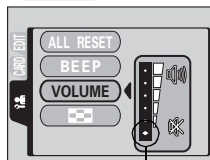

Selecting this level will mute the sound completely.

9 Camera Settings

Formatting cards



This function lets you format a card. Formatting prepares cards to receive data. Before using non-Olympus cards or cards which have been formatted on a PC, you must format them with this camera.

All data stored on the card, including protected pictures, is erased when the card is formatted. When formatting a used card, confirm there are no pictures that you still want to keep on the card.



- 1 In the top menu, select **MODE MENU** → **CARD** → **CARD SETUP**, and press . In **SET UP** mode, select **CARD** → **CARD SETUP**, and press .

“Menu basics” (P.38)

- **PASM** **SET UP**: The **FORMAT** screen is displayed.
- : The **CARD SETUP** screen is displayed.

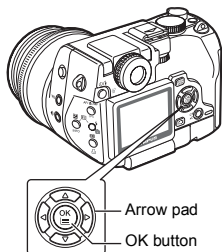

- 2 If the mode dial is set to **P A S M** **SET UP**, press to select **YES**.

If the mode dial is set to , press to select **FORMAT**, then press . The **FORMAT** screen is displayed. Press to select **YES**.

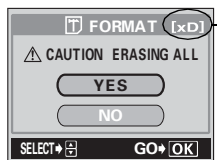

The card to be formatted is displayed.

- 3 Press .

- The **BUSY** bar is displayed and the card is formatted.



- Do not perform any of the following actions during formatting as they may render the card unusable.



Open the card cover, remove the battery, connect or disconnect the AC adapter (regardless of whether or not the battery is loaded in the camera).





This function lets you select a language for on-screen display. This reference manual shows the English on-screen display in illustrations and explanations. Available languages vary depending on the area where you purchased this camera.

Mode dial

SET UP

- 1 Select **SETUP** → , then press .
 “Menu basics” (P.38)

- 2 Press   to select a language, then press .

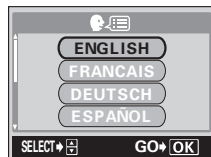
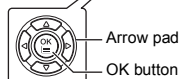
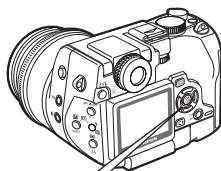

Setting the date and time



The date/time is saved with recorded pictures and file names are assigned based on the date/time settings.

Mode dial

SET UP

1 Select SETUP → , then press .

☞ “Menu basics” (P.38)

- Press repeatedly until is displayed on the monitor.

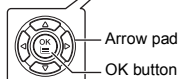
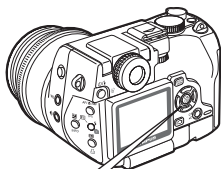

2 Press to select one of the following date formats:

Y-M-D (Year/Month/Day),

M-D-Y (Month/Day/Year),

D-M-Y (Day/Month/Year).

Then press .

- Move to the year setting.
- The following steps show the procedure used when the date and time settings are set to Y-M-D.

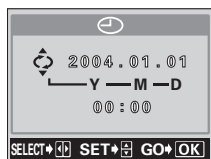

3 Press to set the year, then press to move to the month setting.

- To move back to the previous setting, press .
- The first two digits of the year are fixed.

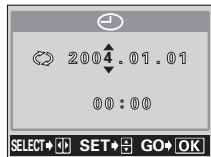

4 Repeat this procedure until the date and time are completely set.

- The time is displayed in the 24-hour format. For example, 2pm will be displayed as 14:00.

5 Press .

- For a more accurate setting, press when the time signal hits 00 seconds.



- The date and time settings will be returned to the factory default setting if the camera is left without the battery for a few days. The settings will be canceled more quickly if the battery was only loaded in the camera for a short time before being removed. Check that the correct date and time have been set before shooting.

Setting the warning tone



You can select the volume of the beep sound used for warnings from OFF, LOW, or HIGH. You can turn the sound off completely by setting OFF.

Mode dial

SET UP

- 1 Select **SETUP** → **■|||** → **OFF, LOW or HIGH**, and press **OK**.

☞ "Menu basics" (P.38)

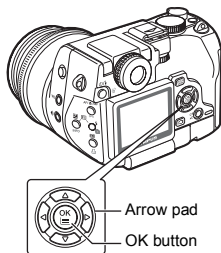

SLEEP – Setting the time until the camera enters sleep mode

The camera automatically enters the sleep mode after being left unoperated for a preset length of time. Press the shutter button or arrow pad to cancel the sleep mode and reactivate the camera.

Mode dial

SET UP

- 1 Select **SETUP** → **SLEEP** → **30 SEC, 1 MIN, 3 MIN, 5 MIN or 10 MIN**, and press **OK**.

☞ "Menu basics" (P.38)

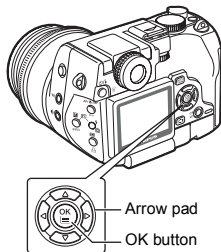

Note

- The camera will not enter sleep mode when powered by the AC adapter.
- In **▶** mode, the camera will enter sleep mode and the monitor will turn off after 3 minutes of non-operation, regardless of the time set in the sleep timer.
- In slideshow mode, the camera will enter sleep mode and the monitor will turn off after 30 minutes.
- In shooting mode, when the powersaving mode is set to ON, the camera will enter sleep mode and the viewfinder will turn off after 10 seconds, regardless of the time set in the sleep timer.

FILE NAME – Assigning a file name

The camera automatically creates file names and folder names for images to be stored in. Files can be numbered from 0001 to 9999 and folders can be numbered from 100 to 999. Examples are shown below.

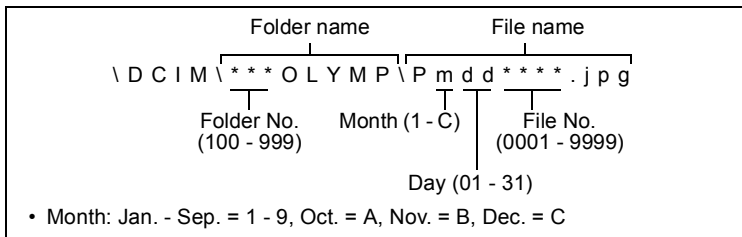

There are two settings from which you can choose: RESET or AUTO. Choose the one that is best for you when transferring images to a PC.

File name settings

RESET The file number and folder number are reset every time a new card is inserted in the camera. The folder number returns to No. 100 and the file number returns to No. 0001. This method is useful when grouping files on separate cards.

AUTO Even if a new card is inserted, the folder number and file number are retained from the previous card, so the same file number is not used on different cards. This helps you to manage multiple cards. This method is useful when you want to manage all your files with sequential numbers.

Mode dial

SET UP

1 In the top menu, select **SETUP** → **FILE NAME** → **RESET** or **AUTO**, and press .

 "Menu basics" (P.38)

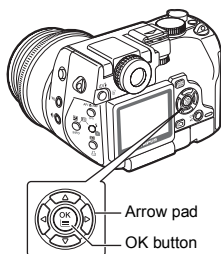





Note

- When the File No. reaches 9999, the file number returns to 0001 and the folder number changes.
- When both the Folder and File No. reach their respective maximum number (999/9999), the number of storable pictures becomes 0 even if the card is not full. No more pictures can be taken. Replace the card with a new one.

BATTERY SAVE

– Reducing battery consumption

This function reduces battery consumption by restricting the following camera operations in the shooting mode.

- The monitor does not turn on when  is pressed.
- The camera automatically enters sleep mode and the viewfinder turns off after 10 seconds of non-operation.
- In **P**     mode, the fastest shutter speed automatically selected by the camera is 1/2000 sec.

Mode dial

SET UP

- 1 Select **SETUP** → **BATTERY SAVE** → **ON** or **OFF**, and press .

 “Menu basics” (P.38)

- To enable the powersaving mode, select ON.

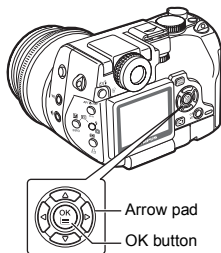

PIXEL MAPPING – Checking the image processing functions

The Pixel Mapping feature allows the camera to check and adjust the CCD and image processing functions. It is not necessary to operate this function frequently. Approximately once a year is recommended. Wait over a minute after the monitor is used or continuous shots are taken to allow for proper performance of the Pixel Mapping function.

Mode dial

SET UP

1 Select SETUP → PIXEL MAPPING, and press .

 “Menu basics” (P.38)

- START appears.

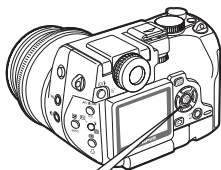

2 Press .

- The **BUSY** bar is displayed during Pixel Mapping. When Pixel Mapping is finished, the screen returns to the **SET UP** mode menu.



9

Camera Settings



Note

- If you accidentally turn the camera off during Pixel Mapping, start again from Step 1.

Adjusting the brightness of the monitor and viewfinder



This function lets you adjust the brightness of the monitor and viewfinder. The brightness of the monitor and viewfinder can be adjusted separately.

Mode dial

SET UP

1 Select **SETUP** → and press .

“Menu basics” (P.38)

2 Press to adjust the brightness of the monitor or viewfinder, and when you have set the desired level, press .

- Pressing brightens the monitor or viewfinder, and pressing darkens it.

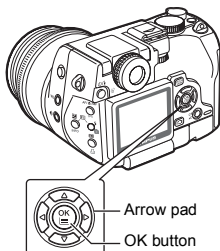

Measurement units

m/ft

The measurement unit can be selected from either meters or feet in the manual focus mode.

- m** At long ranges, the camera measures in meters, and at short ranges in centimeters.
- ft** At long ranges, the camera measures in feet, and at short ranges in inches.

Mode dial

SET UP

1 Select **SETUP** → **m/ft** → **m** or **ft**, and press .

“Menu basics” (P.38)

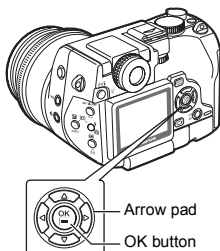

9

Camera Settings

VIDEO OUT – Setting the video signal type

You can select NTSC or PAL according to your TV's video signal type. Select the video signal type before connecting the AV cable. If you use the wrong video signal type, you will not be able to play back the recorded pictures properly on your TV.

Mode dial

SET UP

- 1 Select **SETUP** → **VIDEO OUT** → **NTSC** or **PAL**, and press .

 "Menu basics" (P.38)

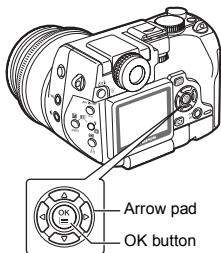

TIPS

TV video signal types & main regions

Check the video signal type before connecting the camera to your TV.

NTSC North America, Japan, Taiwan, Korea

PAL European countries, China

USB setup – Setting the connection destination

Before connecting the USB cable, set the camera to either PC or printer, whichever you intend to connect the camera to.

- PC** Select when connecting the camera to a PC with the USB cable and transferring pictures to the PC. For instructions on how to connect the camera to your PC, refer to the “OPERATION MANUAL” (DIGITAL CAMERA - PC CONNECTION).
- PRINT** Select when connecting the camera to a PictBridge-compatible printer with the USB cable. Pictures can be printed directly without using a PC.  “Connecting the camera to a printer” (P.187)

Mode dial

SET UP

- 1 Select **SETUP** → **USB** → **PC** or **PRINT**, and press .

 “Menu basics” (P.38)

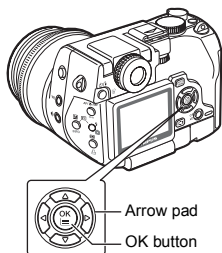



Print reservation allows you to save printing data (the number of prints and date/time information) with the pictures stored on the card.

With print reservation, you can print out pictures easily either at home using a personal DPOF-compatible printer or at a photo lab or a print shop that supports DPOF.

DPOF is a standard format used to record automatic print information from digital cameras. You can print out pictures automatically, at home or in a print shop, by storing such data as which pictures you wish to print and the number of prints on the card.

Pictures with print reservation data can be printed using the following procedures.

Printing using a DPOF-compatible photo lab or print shop.

You can print the pictures using the print reservation data.

Printing using a DPOF-compatible printer.

Printing is possible directly from a card containing print reservation data without using a PC. For more details, refer to the printer's instruction manual. A PC card adapter may also be necessary.



**TIPS****Picture size and printing**

The resolution of a computer/printer is generally based on the number of dots (pixels) per square inch. This is called dpi (dots per inch). The higher the dpi value, the better the printed results. Keep in mind, however, that the dpi of the picture does not change. This means that when you print an image with a higher resolution, the size of the printed picture will be smaller. Although you can print magnified images, picture quality will decrease.

If you want to print large, high-quality pictures, set the record mode as high as possible when taking the pictures.  "Record mode" (P.102)



Note

- DPOF reservations set by another device cannot be changed by this camera. Make changes using the original device.
- If a card contains DPOF reservations set by another device, entering reservations using this camera may overwrite the previous reservations.
- If there is not enough space in the card memory, you may not be able to enter the reservation data. CARD FULL will be displayed.
- You can make DPOF print reservations for up to 999 images per card.
- Even if an image appears with the message "PICTURE ERROR", it may be possible to make print reservations. In this case, the print reservation icon () does not appear when the image is displayed for full view.  appears when multiple images are displayed (index display), allowing you to confirm the print reservation.
- Not all functions may be available on all printers, at all print shops, or at all photo labs.
- Some TIFF images cannot be printed.
- Print reservation may take considerable time when saving printing data to a card.
- Print reservations cannot be made for images recorded in RAW data.

Use this feature to print all the pictures stored on the card. Select the desired number of prints and whether you want the date and time included.

Mode dial



1 Play back a still picture.

- You cannot make print reservations for pictures with .

Print button

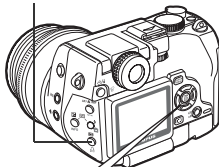

Arrow pad

OK button

2 Press . The PRINT ORDER screen appears.

- If print reservation data is already stored on the card, the PRINT ORDER SETTING screen appears, giving you the choice of resetting the data or keeping it.

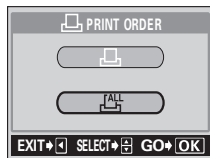



3 Press to select FALL, then press .

4 Press to select x (number of prints) or (date/time), then press .

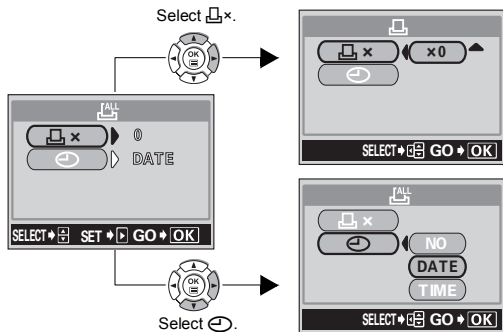
5 Perform each setting as illustrated.



● Set the number of prints

Press   to set the desired number of prints, then press .

 : Increases the number.

 : Decreases the number.

● Set the date/time printing data

Press   to select NO, DATE or TIME, then press .

NO The pictures are printed without the date and time.

DATE All the pictures are printed with the shooting date.

TIME All the pictures are printed with the shooting time.

- After completing the number of prints or the date/time printing data setting, press  to return to the playback screen.

Single-frame reservation



Use this feature to print only selected pictures. Display the picture to be printed and select the desired number of prints.

Mode dial



1 Play back a still picture.

- You cannot make print reservations for pictures with .

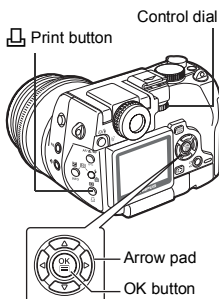

2 Press . The PRINT ORDER screen appears.

- If there is a print reserved data on the card, the PRINT ORDER SETTING screen appears, giving you the choice of resetting the data or keeping it.

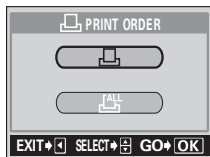

3 Press to select , then press .

4 Select the frame you want to print using the arrow pad or the control dial and press .



5 Select the appropriate item using the arrow pad.

MORE

Sets the number of prints, date/time and trim size. The print reservation data is set and the screen proceeds to Step 6.

SINGLE PRINT

Sets single-frame print. The date/time and trimming settings are not available. → Step 9

CANCEL

Cancels the print reservation for the displayed picture. "To reset the print reservation data for a selected picture" (P.185)

END

Completes the print reservation. → Step 11



Single-frame reservation menu

- 6 Press to select x (number of prints), (date/time) or (trimming), then press .



7 Perform each setting.

● Set the number of prints

Press to set the desired number of prints, then press .

: Increases the number.

: Decreases the number.

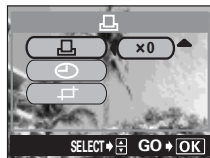

● Set the date/time printing data

Press to select NO, DATE or TIME, then press .

NO The pictures are printed without the date and time.

DATE All the selected pictures are printed with the shooting date.

TIME All the selected pictures are printed with the shooting time.

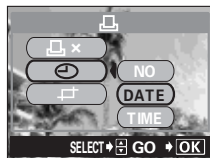

● Trim the picture

"Trimming" (P.182)

- 8 After completing all the print reservations, press to complete the print reservations and return to the screen in Step 4.

- The icon appears on the displayed picture.
- Repeat steps 4 to 8 to make print reservations for other images.

- 9 Press to display the single-frame reservation menu.

- 10 Press to select END.

- The PRINT ORDER screen appears.

- 11 Press again to display the PRINT ORDER SETTING screen, then press once more to complete the print reservations.

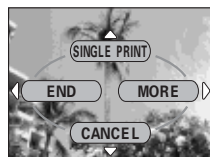



This function enables you to crop part of a recorded picture and print out the enlarged section only.

Mode dial



1 Press on the single-frame reservation screen to select (trimming) and press .

"Single-frame reservation" (P.180)

- If trimming has already been set, the screen appears. Press to select RESET, then press .

2 Use the arrow pad, zoom lever, and control dial to decide the trimming position and size.

- Press to select the trimming frame, and press the zoom lever toward W or T to decide the trimming size.
- Use the control dial to select the height and width of the trimming frame.
- 3:2 trimming size can be selected when the size of the selected picture is 3264 × 2448 or 3264 × 2176.



Control dial

Zoom lever

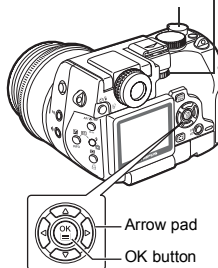

3 Press .



4 Press to select OK, then press .

OK Saves the current trimming size and returns to the single-frame reservation screen.





RESET Sets a new trimming size. → Step 2

CANCEL Cancels the current trimming setting and returns to the single-frame reservation screen.



5 Press to complete the print reservations and return to the picture selection screen. Press again.

6 Press  to select END.

- The  PRINT ORDER screen appears.
- Press  again to display the  PRINT ORDER SETTING screen, then press  once more to complete the print reservations.

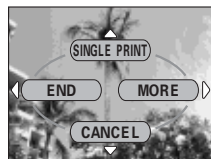

Note

- The size of the printed picture varies depending on the printer settings. If the trimmed picture size is small, printing magnification increases accordingly, resulting in a printed picture with lower resolution.
- For best results with close-up prints, you are recommended to use the TIFF, SHQ or HQ mode.
- The original picture is not trimmed. If your printer does not have a trimming feature, the picture will be printed untrimmed.
- Do not rotate pictures that have been trimmed, otherwise the cropped area will change.

Resetting print reservation data



This function allows you to reset the print reservation data for pictures stored on the card.

You can reset all the print reservation data or just for selected pictures.

● Resetting all print reservation data

Mode dial



1 Press

- The PRINT ORDER SETTING screen appears.

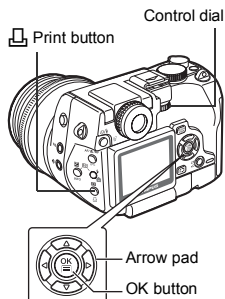

2 Press to select RESET, then press .

















3 Press to exit the menu.

● To reset the print reservation data for a selected picture

Mode dial



- 1 Press .
- 2 Press   to select **KEEP** and press .
 - If there is no print reservation data stored on the card, the  PRINT ORDER SETTING screen does not appear.
- 3 Press   to select , then press .
- 4 Select the frame for which you want to reset the print reservation data using the arrow pad or the control dial and press .
 - The single-frame reservation menu is displayed.
- 5 Press  to select **CANCEL**.
 - The print reservation data is canceled and the screen returns to Step 4.
- 6 If you have finished canceling print reservation data, press .
 - The single-frame reservation menu is displayed.
- 7 Press  to select **END**.
 - Press  repeatedly to return to the playback screen.

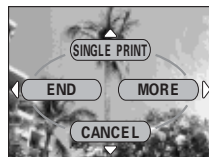



11 Direct printing (PictBridge)

Using the direct printing function

By connecting the camera to a PictBridge-compatible printer with the USB cable, you can print out recorded pictures directly. With the camera connected to the printer, select the pictures you want to print and the number of prints on the camera's monitor. It is also possible to print out pictures using the print reservation data.  "Print setting (DPOF)" (P.176)

To find out if your printer is compatible with PictBridge, refer to the printer's instruction manual.

What is PictBridge? ... It is the standard for connecting digital cameras and printers of different makers and printing out pictures directly.

 **STANDARD** ... All printers that support PictBridge have standard print settings. Selecting  STANDARD on the setting screens ( P.189 to 195), images are printed according to these settings. See the instruction manual for your printer for its standard settings or inquire of the printer manufacturers.



Note

- You are recommended to use the optional AC adapter when printing pictures. If you use the battery, make sure that it is fully charged. If the camera stops operating while communicating with the printer, the printer may malfunction or image data may be lost.
- Images recorded in RAW data and movies cannot be printed.
- The camera will not enter sleep mode when connected to the USB cable.

Connecting the camera to a printer

Use the USB cable provided to connect the camera to a PictBridge-compatible printer.

1 Set the camera's USB mode to PRINT.

☞ "USB setup – Setting the connection destination" (P.175)

- Make sure the card containing the pictures you want to print is selected.

2 Turn the printer on and plug the printer end of the USB cable into the printer's USB port.

- For details of how to turn the printer on and the position of the USB port, refer to the printer's instruction manual.

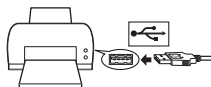

3 Set the camera's mode dial to and plug the USB cable into the camera's USB connector.

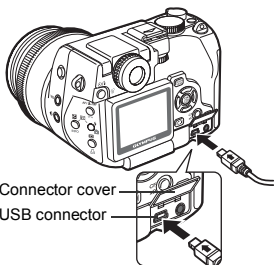

4 Press the power switch to turn the camera on.

- ONE MOMENT is displayed and the camera and printer are connected. The PRINT MODE SELECT screen is displayed on the monitor. Make the print settings on the camera's monitor. Go to ☞ "Printing pictures" (P.188).

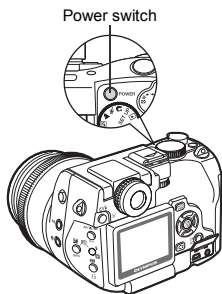

- When the USB mode is set to PC, the PRINT MODE SELECT screen is not displayed. Remove the USB cable, and repeat the procedure from Step 1.

Note

Printing pictures

When the camera is connected correctly to a PictBridge-compatible printer, the PRINT MODE SELECT screen is displayed on the monitor. Use this screen to select the print mode. You can choose from the following print modes.

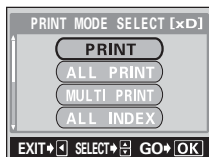

PRINT MODE SELECT screen

- PRINT** Prints the selected picture.
☞ "PRINT/MULTI PRINT" (P.190)
- ALL PRINT** Prints all the pictures stored on the card.
☞ "ALL PRINT" (P.193)
- MULTI PRINT** Prints one picture in multiple layout format.
☞ "PRINT/MULTI PRINT" (P.190)
- ALL INDEX** Prints an index of all the pictures stored on the card.
☞ "ALL INDEX mode/PRINT ORDER mode" (P.195)
- PRINT ORDER** Prints the pictures according to the print reservation data on the card. If no print reservations (P.176) have been made, this option is not available.
☞ "ALL INDEX mode/PRINT ORDER mode" (P.195)

PRINT modes and each setting

Available printing modes, paper sizes etc., vary depending on the printer you use. Please consult with the services of your printer's manufacture or to the printer manual.



Easy printing

The method described below is the easiest way to print out pictures. The selected picture is printed without the date, time or file name.

1 In the PRINT MODE SELECT screen (P.188), press   to select PRINT, then press .

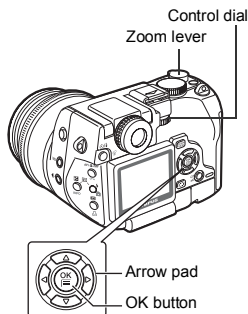

- The PRINT PAPER screen is displayed.





2 Press   to select the paper size, then press .



- When the PRINT PAPER screen is not displayed, SIZE, BORDERLESS and PICS/SHEET are set to  STANDARD. → Go to Step 4.

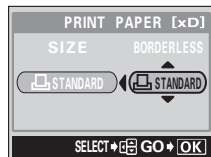

3 Use   to select framed or unframed, then press .

- OFF** () The image is printed inside a blank frame.
- ON** () The image is printed filling the entire page.



4 Press   or turn the control dial to select the picture you want to print and press .

- The PRINT screen is displayed.



5 Press   to select OK, then press .

- Printing starts.
- To cancel printing, select CANCEL and press . The PRINT MODE SELECT screen is displayed.
- When printing is finished, the screen returns to Step 4. Repeat Steps 4 and 5 and print all the pictures you want to print.

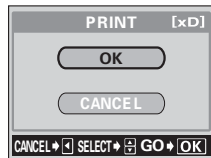

PRINT/MULTI PRINT

1 In the **PRINT MODE SELECT** screen, press to select **PRINT** or **MULTI PRINT**, then press .

- The **PRINT PAPER** screen is displayed.

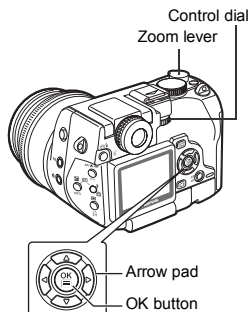

2 Press to select the paper size, then press .

- **PRINT mode:**
→ Go to Step 3.
- **MULTI PRINT mode:**
→ Go to Step 4.
- When the **PRINT PAPER** screen is not displayed, **SIZE**, **BORDERLESS** and **PICS/SHEET** are set to **STANDARD**. → Go to Step 5.

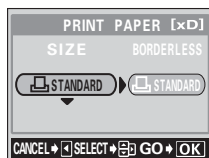

3 Use to select **framed or unframed**, then press . → Go to step 5.

- OFF** () The image is printed inside a blank frame.
- ON** () The image is printed filling the entire page.



4 Press to select **PICS/SHEET**, then press .

- **PICS/SHEET** depends on the paper size set in Step 2 and the capabilities of your printer.

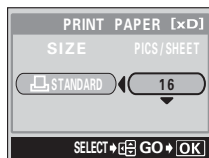

5 Press or turn the control dial to select the picture you want to print.

- Turn the zoom lever toward **W** to display the picture in index format. You can then select the pictures you want to print from the index.





6 Select the print reservation method.

SINGLE PRINT Makes a single-frame print reservation for the selected picture according to standard settings.

MORE Sets the number of prints of the selected picture in the print reservation data. You can also add the date or file name, and trim the picture.

● Set a SINGLE PRINT reservation

Press .

- Press  when the picture with  is displayed to cancel the reservation.

Print reservation mark is displayed.





● Set MORE print reservations

① Press .

- The Print information settings screen is displayed.

② Press   to select the item you want to set, then press .

- Press   to select the item, then press .

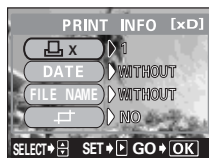

 x

Sets the number of prints. You can select up to 10 prints.

DATE ()

If you select WITH, pictures are printed with the date and time.

FILE NAME ()

If you select WITH, pictures are printed with the file name.



Crops part of a recorded picture so that only the enlarged section is printed.

 "Trim the picture" (P.197)

- DATE and FILE NAME are not available in MULTI PRINT mode.

③ **When you have finished all the settings for MORE, press** .

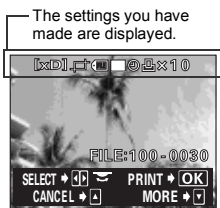

- The screen displayed in Step 5 appears.
- To print more than one picture in PRINT and/or MULTI PRINT mode, repeat Steps 5 and 6 and make single and/or multiple print reservations for all the pictures you want to print.
-  is displayed in MULTI PRINT mode.



7 Press .

- The PRINT screen is displayed.

8 Print the pictures.

- Press  or  to select OK or CANCEL, then press .

OK Printing starts.

CANCEL The settings are canceled and the monitor returns to the PRINT MODE SELECT screen.



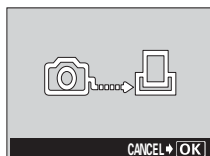

- When printing is finished, the monitor returns to the PRINT MODE SELECT screen.
-  "Exiting direct printing" (P.198)



Data transfer screen

● To cancel printing

Pressing  during print data transfer displays the screen for selecting whether to continue or cancel printing. To cancel printing, press  to select CANCEL, then press .

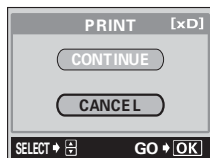

ALL PRINT

- 1** In the **PRINT MODE SELECT** screen, press to select **ALL PRINT**, then press .

- The PRINT PAPER screen is displayed.

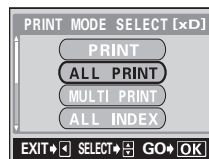

- 2** Press to select the paper size, then press .

- When the PRINT PAPER screen is not displayed, SIZE and BORDERLESS are set to STANDARD.
→ Go to Step 4.

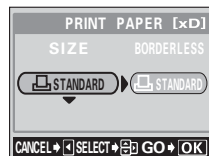

- 3** Use to select framed or unframed, then press .

OFF () The image is printed inside a blank frame.

ON () The image is printed filling the entire page.

- The PRINT INFO screen is displayed.

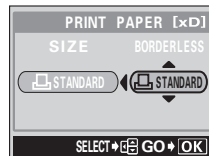

- 4** Press to select the item you want to set, then press .

- Press to select the item, then press .
- If PRINT INFO cannot be set with your printer, go to Step 6.
- Only one print can be made at a time.

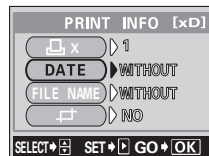



DATE () If you select WITH, pictures are printed with the date and time.

FILE NAME () If you select WITH, pictures are printed with the file name.

5 Press .

- The PRINT screen is displayed.

6 Print the pictures.

- Press   to select OK or CANCEL, then press .

OK Printing starts.

CANCEL The settings are canceled and the monitor returns to the PRINT MODE SELECT screen.



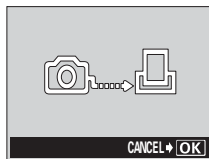
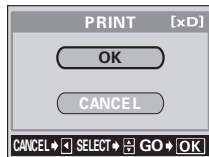

- When printing is finished, the monitor returns to the PRINT MODE SELECT screen.

 "Exiting direct printing" (P.198)



Data transfer screen

● To cancel printing

Pressing  during print data transfer displays the screen for selecting whether to continue or cancel printing. To cancel printing, press   to select CANCEL, then press .

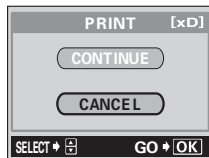

ALL INDEX mode/PRINT ORDER mode

- 1** In the PRINT MODE SELECT screen, press to select ALL INDEX or PRINT ORDER, then press .

- The PRINT PAPER screen is displayed.

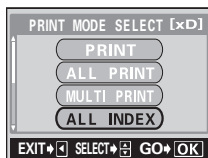

- 2** Press to select the paper size, then press .

- When the PRINT PAPER screen is not displayed, SIZE and BORDERLESS are set to STANDARD. → Go to Step 4.



- 3** Use to select framed or unframed, then press .

OFF () The image is printed inside a blank frame.

ON () The image is printed filling the entire page.

- The PRINT screen is displayed.
- BORDERLESS is not available in ALL INDEX mode. Press and go to Step 4.



- 4** Print the pictures.

- Press to select OK or CANCEL, then press .

OK Printing starts.

CANCEL The settings are canceled and the monitor returns to the PRINT MODE SELECT screen.





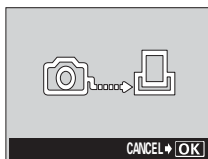

- When printing is finished, the monitor returns to the PRINT MODE SELECT screen.

"Exiting direct printing" (P.198)



Data transfer screen

● To cancel printing

Pressing  during print data transfer displays the screen for selecting whether to continue or cancel printing. To cancel printing, press   to select CANCEL, then press .

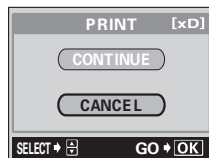

Trim the picture

To set trimming by MORE in PRINT or MULTI PRINT mode, follow the procedure below.

1 Use the arrow pad and zoom lever to select the trimming position and size.

- Press to select the trimming frame, and turn the zoom lever toward W or T to decide the trimming size.
- Use the control dial to select the height and width of the trimming frame.
- 3:2 trimming size can be selected when the size of the selected picture is 3264 × 2448 or 3264 × 2176.
- If trimming has already been set, the screen appears. Press to select RESET, then press .

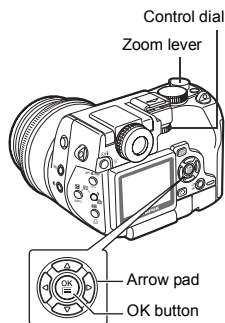

2 Press .



3 Press to select OK, then press .

- OK** Saves the current trimming size.
- RESET** Sets a new trimming size.
→ Repeat the procedure from Step 1.
- CANCEL** Cancels the current trimming setting.



- Press to complete trimming setting and return to the PRINT INFO screen.



- The size of the printed picture varies depending on the printer settings. If the trimmed picture size is small, printing magnification increases accordingly, resulting in a printed picture with lower resolution.
- For best results with close-up prints, you are recommended to use the TIFF, SHQ or HQ mode.

Exiting direct printing

When you have finished printing, disconnect the camera from the printer.

- 1 In the **PRINT MODE SELECT** screen, press .

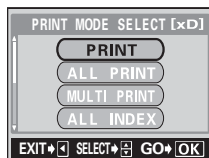

- A message is displayed.

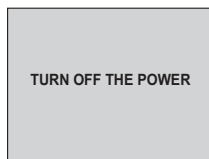

- 2 Press the power switch to turn the camera off.

Power switch

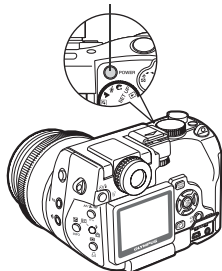

- 3 Remove the USB cable from the camera.

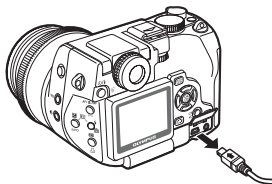



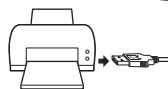

- 4 Remove the USB cable from the printer.



If an error code is displayed

If an error code appears on the camera's monitor during direct print setting or printing, see the following table.

For more details, refer to the printer's instruction manual.

Monitor indication	Possible cause	Corrective action
 NO CONNECTION	The camera is not connected to the printer correctly.	Disconnect the camera and connect it again correctly.
 NO PAPER	There is no paper in the printer.	Load some paper in the printer.
 NO INK	The printer has run out of ink.	Replace the ink cartridge in the printer.
 JAMMED	The paper is jammed.	Remove the jammed paper.
SETTINGS CHANGED	The printer's paper cassette has been removed or the printer has been manipulated while making settings on the camera.	Do not manipulate the printer while making settings on the camera.
 PRINT ERROR	There is a problem with the printer and/or camera.	Turn off the camera and printer. Check the printer and remedy any problems before turning the power on again.











TIPS

- If an error code other than those shown above is displayed, refer to "Error codes" (P.200).

Miscellaneous

Error codes



Monitor indication	Possible cause	Corrective action
 NO CARD	The card is not inserted, or it cannot be recognized.	Insert a card or insert a different card. If the problem persists, format the card. If the card cannot be formatted, it cannot be used.
 CARD ERROR	There is a problem with the card.	This card cannot be used. Insert a new card.
 WRITE-PROTECT	Writing to the card is prohibited.	The recorded image has been protected (read-only) on a PC. Download the image to a PC and cancel the read-only setting.
 CARD FULL	The card is full. No more pictures, movies or information such as print reservations can be recorded.	Replace the card or erase unwanted pictures. Before erasing, download important images to a PC.
 NO PICTURE	There are no pictures on the card.	The card contains no pictures. Record pictures.
 PICTURE ERROR	There is a problem with the selected picture and it cannot be played back on this camera.	Use image processing software to view the picture on a PC. If that cannot be done, the image file is damaged.
 CARD COVER OPEN	The card cover is open.	Close the card cover.
	The card is not formatted.	Format the card. All data on the card will be deleted.
 FILE SIZE SELECTED TOO LARGE	Files with a volume of 57 MB or over (movies of over approx. 64 sec. (SHQ), 70 sec. (HQ) or 685 sec. (SQ)) cannot be copied.	Avoid selecting movies of the type listed left for copying.

Troubleshooting

● Preparatory operations



Possible cause	Corrective action	Ref. page
The camera does not turn on or function buttons do not respond.		
The power is off.	Press the power switch to turn the camera on.	P.25
The battery is exhausted.	Charge the battery.	P.17
The battery is temporarily unable to function because of the cold.	Warm the battery by putting it in your pocket for a while.	—
The camera is in the sleep mode.	Operate the camera (press the shutter button or the zoom lever).	P.26
The camera is connected to a PC.	The camera will not operate while it is connected to a PC.	—









● Shooting

Possible cause	Corrective action	Ref. page
No picture is taken when the shutter button is pressed.		
The battery is exhausted.	Charge the battery.	P.17
The camera is in the playback mode.	Set the mode dial to any position except  .	P.50
The flash has not finished charging.	Remove your finger from the shutter button, and wait until  stops blinking. Press the shutter button again.	P.50, 60
The card is full.	Erase unwanted pictures or insert a new card. Before erasing, download important images to a PC.	P.143
The battery ran out of power during shooting or while the images were being written to the card. (The battery check indicator only blinks.)	Charge the battery. (Wait until the card access lamp turns off when flashing.)	P.17
The memory gauge is full.	Wait until there is room in the memory gauge.	P.14
There is a problem with the card.	Refer to "Error codes".	P.200
The viewfinder does not turn on.		
The monitor is turned on.	Press  to turn the viewfinder on.	P.50



Possible cause	Corrective action	Ref. page
The monitor does not turn on.		
The viewfinder is turned on.	Press  to turn the monitor on.	P.50
The viewfinder or monitor is hard to see.		
The diopter is not adjusted properly.	Adjust the diopter so that the AF target mark is clearly visible.	P.27
There is condensation* inside the camera.	Wait until the camera dries before turning it on again.	—





* Condensation: When it is cold outside, the water vapor in the air is rapidly cooled and turns to droplets of water.
Condensation occurs when the camera is suddenly taken from a cold place into a warm room.





The brightness of the viewfinder or monitor is not adjusted properly.	Select  in the SETUP tab and adjust the brightness.	P.173
The monitor is exposed to direct sunlight.	Position the monitor in the down position or block the sunlight with your hand.	—
Vertical lines appear in the viewfinder or on the monitor screen during shooting.	Aiming the camera at a bright subject in sunlight may cause vertical lines to appear on the screen. This is not a malfunction.	—
The date recorded with the image data is wrong.		
The date/time is not set.	Set the date/time. The clock adjustment is not factory-preset.	P.168
The camera has been left with the battery removed.	If the camera is left for a few days with the battery removed, the date/time setting is canceled. Set the date/time again.	P.18, 168
The settings are returned to the factory default settings when the camera is turned off.		
ALL RESET is set to ON.	Set ALL RESET in the  tab to OFF.	P.145
The picture is out of focus.		
The subject is too close.	Position the camera more than 0.2 m/0.7 ft. from the subject and take the picture. To take pictures closer than 0.2 m/0.7 ft., use the super macro mode.	P.87, 88
Auto focus is not possible.	Use manual focus or focus lock to focus on the subject and then shoot.	P.53, 79
The subject is dark.	Turn the AF illuminator on.	P.78
There is condensation* on the lens.	Wait until the camera dries before turning it on again.	—

Possible cause	Corrective action	Ref. page
The monitor goes off.		
The camera is in the sleep mode.	Operate the camera (press the shutter button or the zoom lever).	P.26
The power is turned off with the monitor off.	If ALL RESET in the  tab is set to OFF, the camera settings before the power was turned off remain unchanged. Turn on the monitor, and turn off the power.	P.50, 145
The flash does not fire.		
The flash is closed.	Press the flash pop-up button to make the flash pop up.	P.59
The flash is set to the flash off mode.	Select a flash mode other than  .	P.59
The subject is illuminated.	If you want the flash to fire on a brightly illuminated subject, set the flash to  .	P.59
Sequential shooting (HI  ,  , AF  , BKT) is set.	The flash does not fire in the sequential shooting mode. Set  in the  menu.	P.92
The camera is in the movie mode.	The flash does not fire in the  mode. Set a different shooting mode.	P.55
Super macro mode is set.	The flash does not fire in the super macro mode. Cancel the super macro mode.	P.88
Panorama mode is set.	The flash does not fire in the panorama mode. Cancel the panorama mode.	P.95
The battery run time is brief.		
You are using the camera in a cold environment.	Battery performance deteriorates in low temperatures. Keep the camera warm by putting it inside your coat or clothing.	—
The remaining battery power is not indicated correctly.	When battery consumption fluctuates considerably, the camera may turn off without displaying the battery warning indicator. Charge the battery.	P.14, 17

● Playback

Possible cause	Corrective action	Ref. page
The picture is out of focus.		
A subject unsuited to AF was taken	Use manual focus or focus lock to focus on the subject and then shoot.	P.53, 79
The camera moved when the shutter button was pressed.	Hold the camera correctly and press the shutter button gently.	P.28
The flash was closed or was set to the flash off mode in a lighting condition requiring use of the flash.	Press the flash pop-up button to make the flash pop up and select a flash mode other than  . Camera movement occurs easily with slower shutter speeds. Use a tripod, or set the flash to AUTO.	P.59
The lens was dirty.	Clean the lens. Use a commercially available blower brush and then wipe with a lens cleaner to remove dust. Mold may form on the lens surface if the lens is left dirty.	P.219
The picture is too bright.		
The flash was set to the  mode.	Select a flash mode other than  .	P.59
The center of the subject is too dark.	If the center of the subject is too dark, the surrounding area emerges as too bright. Adjust the exposure compensation toward minus (-).	P.108
The ISO is at a high setting.	Set the ISO to AUTO or to a low sensitivity: 50	P.107
The aperture value is small in A (M) mode.	Increase the aperture value or set the camera to P mode.	P.70
The shutter speed setting is too slow in S (M) mode.	Increase the shutter speed or set the camera to P mode.	P.71

Possible cause	Corrective action	Ref. page
The picture is too dark.		
The flash was blocked by your finger.	Hold the camera correctly, keeping your fingers away from the flash.	P.28
The subject was out of the working range of the flash.	Shoot within the flash working range.	P.59
The flash was closed or was set to the  mode.	Press the flash pop-up button to make the flash pop up and select a flash mode other than  .	P.59
The subject was too small and was backlit.	Set the flash mode to  , or use the spot metering mode.	P.59, 81
The sequential shooting mode was used.	Higher shutter speeds are used when the sequential shooting mode is selected, which may result in pictures that are darker than usual. Set <input type="checkbox"/> in the sequential shooting menu.	P.92
The center of the subject is too bright.	If the center of the subject is too bright, the image as a whole emerges darker. Adjust the exposure compensation toward plus (+).	P.108
The aperture value setting is too high in A (M) mode.	Decrease the aperture value or set the camera to P mode.	P.70
The shutter speed setting is too fast in S (M) mode.	Reduce the shutter speed or set the camera to P mode.	P.71
The colors of pictures look unnatural.		
Indoor lighting can affect the picture's colors.	Set the white balance according to the lighting.	P.109
No white in the picture.	Include something white in the picture, or set the flash mode to  .	P.59
The white balance setting is wrong.	Adjust the white balance according to the light source.	P.109
Filter was used.	The image may be discolored according to the filter used. Use the one-touch white balance function.	P.111
Part of the picture is too dark		
The lens was partly blocked by your finger or the strap.	Hold the camera correctly, keeping your fingers and the strap away from the lens.	P.28

Possible cause	Corrective action	Ref. page
Halation produces unnatural colors in the picture.		
This may be caused by excessively bright ultraviolet light on the subject, such as sunlight shining through the leaves of trees, window frames in bright light at night, reflection of metal in direct sunlight, etc.	<ul style="list-style-type: none"> Use a UV filter. As this may upset the overall color balance, it should only be used in the conditions described on the left. Process the picture using a graphics application (Photoshop, Paint Shop Pro, etc.). For example, after picking up unnatural colors with a syringe tool, etc. you can select color areas, and try color conversion or saturation adjustment. For details, refer to the manual for the graphics application you are using. 	—
Pictures you have taken do not appear on the monitor.		
The power is off.	Set the mode dial to  before pressing the power switch to turn the camera on.	P.121
The camera is in the shooting mode.	Press the QUICK VIEW button or set the mode dial to  .	P.121, 122
There are no pictures on the card.	NO PICTURE appears on the monitor. Record pictures.	—
There is a problem with the card.	Refer to "Error codes".	P.200
The camera is connected to a TV.	The monitor does not function when the AV cable is connected to the camera.	P.134
Single-frame erase and all-frame erase cannot be performed.		
The pictures are protected.	Display pictures with  and press  button to cancel protection.	P.142
No picture is displayed on the TV when connected to the camera.		
The video output signal is incorrect.	Set the video output signal according to the region where used.	P.174
The TV video signal setting is incorrect.	Set the TV to the video input mode.	P.134
The viewfinder or monitor is hard to see.		
The brightness of the viewfinder or monitor is not adjusted properly.	Select  in the SETUP tab and adjust the brightness.	P.173
The monitor is exposed to direct sunlight.	Position the monitor in the down position or block the sunlight with your hand.	—
Illustrations and explanations are not displayed in English.		
A language other than English has been selected for on-screen display.	Select English for on-screen display.	P.167



























● Connection to a PC or Printer





Possible cause	Corrective action	Ref. page
The camera is not recognized by the PC.		
The USB driver is not installed.	It is necessary to install the USB driver for Windows 98/98SE. For installation instructions, see "OPERATION MANUAL" (Digital camera – PC connection) on the CD-ROM.	—
The camera has not been turned on.	Press the power switch to turn the camera on.	P.25
The printer is selected as the connection destination.	Set the USB option in the SETUP tab to PC.	P.175
The camera cannot be connected to the printer.		
PC is selected as the connection destination.	Set the USB option in the SETUP tab to PRINT.	P.175
The camera or printer has not been turned on.	Turn the camera or printer on.	P.187
The printer does not support PictBridge.	Refer to the printer's instruction manual or contact the manufacturer.	—



List of menus

The shooting mode menus and playback menus for still pictures and movies are shown below.

●P, A, S, M, , , , , mode

Top menu ▶	Tab ▶	Function ▶	Sub-menu ▶	Setting ▶	Ref. page
MODE MENU	CAMERA	FLASH MODE	FLASH MODE	AUTO,  ,  , ⚡ SLOW, 	P.59
				-2.0 to +2.0	P.64
			 FLASH	IN+  ,  SLAVE	P.66, 69
			⚡ SLOW	⚡ SLOW1,  , ⚡ SLOW, ⚡ SLOW2	P.63
		AF/  MF	FOCUS MODE	AF,  , MF,  ,  MF	P.79, 87, 88
			AF MODE	iESP, 	P.74
			FULLTIME AF	OFF, ON	P.75
			P-AF	OFF, ON	P.76
			ESP/ 	ESP,  ,  MULTI, 	P.81
			 *1	 HI,  AF,  BKT	P.92
			 /i	OFF,  , i	P.89, 90
			ISO	AUTO, 50 to 400	P.107
			DIGITAL ZOOM	OFF, ON	P.58
			NOISE REDUCTION *2	OFF, ON	P.118
			FUNCTION	OFF, PANORAMA,  , BLACK & WHITE, SEPIA	P.95, 97, 98
			FRAME ASSIST	OFF, ON	P.99
				OFF, ON	P.100
			MY MODE *3	MY MODE 1 to MY MODE 8	P.73
				OFF,  ON, DIRECT	P.119

PICTURE	WB	AUTO	[WB?], SET	P.109, 112, 113
		PRESET 1	PRESET 1, [WB?], SET	P.110, 112, 113
		PRESET 2	PRESET 2, [WB?], SET	P.110, 112, 113
		CUSTOM	CUSTOM 1 to CUSTOM 4	P.111
			GO, ADJUST, SET	P.111, 112, 113
		RAW	OFF, SHQ, HQ, SQ1, SQ2	P.103, 105, 106
		TIFF	3264 × 2448/ 3264 × 2176 (3:2)/ 2592 × 1944/ 2288 × 1712/ 2048 × 1536/ 1600 × 1200/ 1280 × 960/ 1024 × 768/ 640 × 480	P.102, 105
		SHQ	3264 × 2448/ 3264 × 2176 (3:2)	P.102, 105
		HQ	3264 × 2448/ 3264 × 2176 (3:2)	P.102, 105
		SQ1	2592 × 1944/ 2288 × 1712/ 2048 × 1536	P.102, 105
		SQ2	1600 × 1200/ 1280 × 960/ 1024 × 768/ 640 × 480	P.102, 105
		SCENE MODES ^{*2}	NORMAL,  ,  , 	P.117
		SHARPNESS	-5 to +5	P.114
		CONTRAST	-5 to +5	P.115
		HUE	-5 to +5	P.116
	SATURATION	-5 to +5	P.117	
CARD	CARD SETUP	YES, NO	P.166	

	ALL RESET *4		OFF, ON	P.145
	REC VIEW		OFF, AUTO, 3 SEC, 5 SEC, 10 SEC	P.147
	BEEP		OFF, 1, 2	P.148
	SHUTTER SOUND		OFF, 1, 2	P.149
	DIAL		NORMAL, CUSTOM 1 to CUSTOM 3	P.150
	EV STEP		1/3EV, 1/2EV	P.153
	CUSTOM BUTTON			P.154
	SHORT CUT			P.157
	MY MODE SETUP	CURRENT	MY MODE 1 to MY MODE 8	P.160, 161
		RESET	MY MODE 1 to MY MODE 8	P.160, 162
	CUSTOM	MY MODE 1 to MY MODE 8	P.160, 162	
CONTROL PANEL		OFF, ON	P.163	
 *5			P.92	
(ISO) *5			P.107	
(DIGITAL ZOOM) *5			P.58	

*1 Cannot be selected in  mode.

















*2 Cannot be selected in     mode.

*3 Can be selected only in  mode.

*4 Cannot be selected in  mode.

*5 The function registered in the shortcut menu is displayed.



 mode

Top menu ▶	Tab ▶	Function ▶	Sub-menu ▶	Setting ▶	Ref. page		
MODE MENU	CAMERA	AF/☑/MF	FOCUS MODE	AF, ☑, s☑	P.87, 88		
			FULLTIME AF	OFF, ON	P.75		
		ESP / 		ESP,  	P.81		
		 / 		OFF,  	P.89, 90		
		FUNCTION		OFF, BLACK & WHITE, SEPIA	P.98		
		FRAME ASSIST		OFF, ON	P.99		
		PICTURE	WB		AUTO	 , SET	P.109, 112, 113
					PRESET 1	PRESET 1,  , SET	P.110, 112, 113
					PRESET 2	PRESET 2,  , SET	P.110, 112, 113
					CUSTOM	CUSTOM 1 to CUSTOM 4	P.111
				GO, ADJUST, SET	P.111, 112, 113		
				SHQ, HQ, SQ	P.105		
SCENE MODES				NORMAL,   	P.117		
SHARPNESS				-5 to +5	P.114		
CONTRAST				-5 to +5	P.115		
HUE				-5 to +5	P.116		
SATURATION				-5 to +5	P.117		
CARD	CARD SETUP				YES, NO	P.166	
	ALL RESET				OFF, ON	P.145	
	REC VIEW				OFF, AUTO, 3 SEC, 5 SEC, 10 SEC	P.147	
	BEEP				OFF, 1, 2	P.148	
	DIAL		NORMAL, CUSTOM 1 to CUSTOM 3	P.150			
	EV STEP		1/3EV, 1/2EV	P.153			
	CUSTOM BUTTON			P.154			
	CONTROL PANEL		OFF, ON	P.163			
			OFF, ON	P.101			
ISO			AUTO, 50 to 100	P.107			
DIGITAL ZOOM			OFF, ON	P.58			







● Playback mode (still pictures)

Top menu ▶	Tab ▶	Function ▶	Sub-menu ▶	Setting ▶	Ref. page	
MODE MENU	EDIT	RAW DATA EDIT		TIFF, SHQ, HQ, SQ1, SQ2	P.140	
				-5 to +5	P.140	
			WB	AUTO, PRESET 1, PRESET 2, CUSTOM,	P.140	
				RED 7 to BLUE 7	P.140	
			SCENE MODES	NORMAL, , ,	P.140	
			SHARPNESS	-5 to +5	P.140	
			CONTRAST	-5 to +5	P.140	
			HUE	-5 to +5	P.140	
			SATURATION	-5 to +5	P.140	
			FUNCTION	OFF, BLACK & WHITE, SEPIA	P.140	
					P.140	
				640 × 480, 320 × 240, CANCEL	P.138	
				NEW FILE, CANCEL	P.139	
			COPY	ALL, SELECT	P.141	
			CARD	CARD SETUP	ALL ERASE, FORMAT	P.144, 166
				ALL RESET	OFF, ON	P.145
				BEEP	OFF, 1, 2	P.148
				VOLUME	0 to 5	P.165
					4, 9, 16	P.126
				P.127		
		OFF, ON	P.136			
		OFF, ON	P.137			

● Playback mode (movies)

Top menu ▶	Tab ▶	Function ▶	Sub-menu ▶	Setting ▶	Ref. page
MODE MENU	CARD	CARD SETUP		ALL ERASE, FORMAT	P.144, 166
		ALL RESET		OFF, ON	P.145
		BEEP		OFF, 1, 2	P.148
		VOLUME		0 to 5	P.165
				4, 9, 16	P.126
MOVIE PLAY				MOVIE PLAYBACK, INDEX, EDIT	P.128
COPY				ALL, SELECT	P.141

● SET UP mode

Top menu ▶	Tab ▶	Function ▶	Sub-menu ▶	Setting ▶	Ref. page	
		CARD	CARD SETUP	YES, NO	P.166	
		ALL RESET		OFF, ON	P.145	
		REC VIEW		OFF, AUTO, 3 SEC, 5 SEC, 10 SEC	P.147	
		BEEP		OFF, 1, 2	P.148	
		SHUTTER SOUND		OFF, 1, 2	P.149	
		DIAL		NORMAL, CUSTOM 1 to CUSTOM 3	P.150	
		EV STEP		1/3EV, 1/2EV	P.153	
		CUSTOM BUTTON			P.154	
		SHORT CUT			P.157	
		MY MODE SETUP		RESET	MY MODE 1 to MY MODE 8	P.160, 162
				CUSTOM	MY MODE 1 to MY MODE 8	P.160, 162
		CONTROL PANEL			OFF, ON	P.163
		VOLUME			0 to 5	P.165
					4, 9, 16	P.126
SETUP					ENGLISH, FRANCAIS, DEUTSCH, ESPAÑOL, ITALIANO, РУССКИЙ, PORTUGUES, 日本語	P.167
						
				OFF, LOW, HIGH	P.169	
	SLEEP			30 SEC, 1 MIN, 3 MIN 5 MIN, 10 MIN	P.169	
	FILE NAME			RESET, AUTO	P.170	
	BATTERY SAVE			OFF, ON	P.171	
	PIXEL MAPPING			START	P.172	
					P.173	
	m/ft			m, ft	P.173	
	VIDEO OUT			NTSC, PAL	P.174	
	AF ILLUMINATOR			OFF, ON	P.78	
	USB			PC, PRINT	P.175	

List of factory default settings

The menu functions are set to the following default settings at the time of purchase.

Shooting mode

FNo.	F2.4
Program shift	RESET
SHUTTER	1/1000
Zoom	28mm
LCD/EVF	LCD
CARD	xD
	0.0
FLASH	AUTO (S, M: SLOW,
	0.0
FLASH	IN+
SLAVE	1
SLOW	SLOW1
AF/ MF	AF
AF target mark	Center
AF MODE	iESP
FULLTIME AF	OFF
P-AF	ON
ESP/	ESP
Metering target	Center
BKT	±1.0, 3 pictures
	OFF
ISO	AUTO (A, S, M: 50)
DIGITAL ZOOM	OFF



NOISE REDUCTION	OFF (): fixed ON
FUNCTION	OFF
FRAME ASSIST	OFF
	OFF
(movie)	ON
HISTOGRAM	OFF
Histogram target mark	Center
MY MODE	MY MODE 1
WB	AUTO
	None
CUSTOM WB	Not Registered
	HQ (3264 × 2448, : 320 × 240)
JPEG	OFF
TIFF	3264 × 2448
SHQ	3264 × 2448
HQ	3264 × 2448
SQ1	2048 × 1536 NORMAL
SQ2	640 × 480 NORMAL
SCENE MODES	NORMAL
SHARPNESS	±0
CONTRAST	±0
HUE	±0
SATURATION	±0





Playback mode

INFO	OFF
	OFF
	0°
	OFF

	OFF
	OFF
COPY	ALL

SETUP

ALL RESET	ON
REC VIEW	ON
BEEP	1-LOW
SHUTTER SOUND	1-LOW
DIAL	NORMAL
EV STEP	1/3EV
CUSTOM BUTTON	ISO
SHORT CUT	A:  , B: ISO C: DIGITAL ZOOM
CONTROL PANEL	OFF
VOLUME	3
	9

	ENGLISH
	Y-M-D 2004/01/01 00:00
	LOW
SLEEP	3 MIN
FILE NAME	AUTO
BATTERY SAVE	OFF
	NORMAL
m/ft	m
VIDEO OUT	NTSC or PAL*
AF ILLUMINATOR	ON
USB	PC

* Setting differ according to the region where the camera is sold.

Function	Mode						
	P	A	S	M			
ISO				✓			
		✓			—		✓
WB				✓			
				✓			
CUSTOM WB				✓			
SHARPNESS				✓			
CONTRAST				✓			
HUE				✓			
SATURATION				✓			
SCENE MODES			✓			—	✓
NOISE REDUCTION			✓			—	
ALL RESET				✓ ^{*2}			
REC VIEW				✓			—
BEEP				✓			
SHUTTER SOUND				✓			—
DIAL				✓			
EV STEP				✓			
CUSTOM BUTTON				✓			
SHORT CUT				✓			—
MY MODE				✓			—
CONTROL PANEL				✓			

✓: Available —: Not available

*1 Cannot be selected in mode

*2 Cannot be selected in mode

Camera maintenance

● After use

Turn off the camera, detach the lens hood, and then fit the lens cap on the lens. If you do not intend to use the camera for a long period, remove the battery.

● Cleaning the camera

- 1 Turn off the camera. (☞ P.25)
- 2 Remove the battery (☞ P.18). (If you are using an AC adapter, unplug the AC adapter from the camera first before removing the plug from the AC outlet.)

3 Exterior:

→ Wipe gently with a soft cloth. If the camera is very dirty, soak the cloth in mild soapy water and wring well. Wipe the camera with the damp cloth and then dry it with a dry cloth. If you have used the camera at the beach, use a cloth soaked in clean water and well wrung.

Monitor and viewfinder:

→ Wipe gently with a soft cloth.

Lens

→ Blow dust off the lens with a commercially available blower, then wipe gently with a lens cleaner.

Card

→ Wipe gently with a soft, dry cloth.

● Storage

- When storing the camera for extended periods, remove the battery and the card, and keep in a cool, dry place that is ventilated well.
- Periodically, replace the battery, and test camera functions.



- Do not use strong solvents such as benzene or alcohol, or chemically treated cloth.
- Cleaning should be done only after the battery has been removed or the AC adapter has been disconnected.
- Mold may form on the lens surface if the lens is left dirty.
- Avoid leaving the camera in places where chemical products are handled since this may result in corrosion.

How to replace the battery (CR2025) of the remote control device

- 1 Turn the screw on the bottom of the remote control device counterclockwise to loosen.

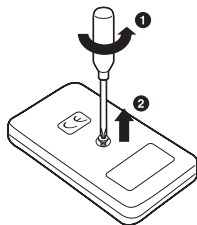

- 2 Turn the remote control device over, and remove the cover. Remove the old battery and insert a new battery (CR2025) with the battery facing up as shown.

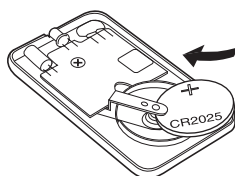

- 3 Replace the cover, turn the remote control device over, and turn the screw on the bottom clockwise to tighten.

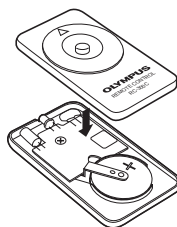

Note

- Do not apply excessive force to the remote control device.
- Never heat the remote control device or dispose of it in fire.
- The working temperature range for the remote control device is -10°C to 40°C (14°F to 104°F).

Specifications

Product type	: Digital camera (for shooting and displaying)
Recording system	
Still picture	: Digital recording, TIFF (non-compression), JPEG (in accordance with Design rule for Camera File system (DCF)), RAW Data
Applicable standards	: Exif 2.2, Digital Print Order Format (DPOF), PRINT Image Matching II, PictBridge
Sound with still pictures	: Wave format
Movie	: QuickTime Motion JPEG support
Memory	: xD-Picture Card (16-512MB), CompactFlash, Microdrive* *340 MB Microdrive cannot be used.
Recording image resolution	: 3264 × 2448 pixels (RAW, TIFF, SHQ, HQ) 3264 × 2176 pixels (3:2, TIFF, SHQ, HQ) 2592 × 1944 pixels (TIFF, SQ1) 2288 × 1712 pixels (TIFF, SQ1) 2048 × 1536 pixels (TIFF, SQ1) 1600 × 1200 pixels (TIFF, SQ2) 1280 × 960 pixels (TIFF, SQ2) 1024 × 768 pixels (TIFF, SQ2) 640 × 480 pixels (TIFF, SQ2)
No. of storable pictures	
When a 32 MB card is used (without sound)	: Approx. 2 frames (RAW : 3264 × 2448) Approx. 1 frame (TIFF : 3264 × 2448) Approx. 8 frames (SHQ : 3264 × 2448) Approx. 16 frames (HQ : 3264 × 2448) Approx. 40 frames (SQ1 : 2048 × 1536 NORMAL) Approx. 331 frames (SQ2 : 640 × 480 NORMAL)
No. of effective pixels	: 8,000,000 pixels
Image pickup device	: 2/3" CCD solid-state image pickup, 8,310,000 pixels
Lens	: Olympus lens 7.1 mm to 35.6 mm, f2.4 to f3.5, 14 elements in 5 groups (equivalent to 28 mm to 140 mm lens on 35 mm camera)
Photometric system	: Digital ESP metering, spot metering system, center-weighted metering system
Aperture	: f2.4 to f8.0
Shutter speed	: 16 to 1/4000 sec. (bulb mode: max. 8 min.)
Shooting range	: 0.8 m (2.6 ft.) to ∞ (normal) 0.2 m to 0.8 m (0.7 ft to 2.6 ft.) (macro mode)
Viewfinder	: 0.44" TFT color LCD display, 240,000 pixels
Monitor	: 1.8" TFT color LCD display, 134,000 pixels

Autofocus	: Dual autofocus Contrast detection system, Phase-difference detection system
Outer connector	: DC-IN jack, USB connector (mini-B), A/V OUT jack
Automatic calendar system	: 2000 up to 2099
Operating environment	
Temperature	: 0°C to 40°C (32°F to 104°F) (operation) -20°C to 60°C (-4°F to 140°F) (storage)
Humidity	: 30% to 90% (operation)/10% to 90% (storage)
Power supply	: Only an Olympus BLM-1 lithium-ion battery AC adapter specified by Olympus (optional)
Dimensions	: 124 mm (W) × 84.5 mm (H) × 99 mm (D) (4.9" × 3.3" × 3.9") (excluding protrusions)
Weight	: Approx. 510 g (1.1 lb.) (without battery and card)

SPECIFICATIONS ARE SUBJECT TO CHANGE WITHOUT ANY NOTICE OR OBLIGATION ON THE PART OF THE MANUFACTURER.

Lens filter - - - - -

A lens filter can be fitted to the lens. For more information, please refer to our web site.

- - - - -

A (Aperture Priority) Mode

You set the aperture yourself and the camera automatically varies the shutter speed so that the picture is taken with the best exposure.

AE (Automatic Exposure)

The camera's built-in exposure meter automatically sets the exposure. The 3 AE modes available on this camera are **P** mode, in which the camera selects both the aperture and shutter speed, **A** mode, in which the user selects the aperture and the camera sets the shutter speed, and **S** mode, in which the user selects the shutter speed and the camera sets the aperture. In **M** mode, the user selects both the aperture and the shutter speed.

Aperture

The adjustable lens opening which controls the amount of light that enters the camera. The larger the aperture, the shorter the depth of field and the fuzzier the background. The smaller the aperture, the greater the depth of field and the sharper the background. Larger aperture values indicate smaller apertures, and smaller aperture values indicate larger apertures.

Backlight

A light source to illuminate the monitor from behind the screen.

CCD (Charge-Coupled Device)

This converts light passing through the lens into electrical signals. On this camera, light is picked up and converted into RGB signals to build a single image.

Contrast Detection System

This is used to measure the distance to the subject. The camera determines if the image is focused by the level of contrast in the subject.

Conventional Photograph

This refers to recording images using silver halide (the method for recording images in conventional, non-digital photography). This system is in contrast to still video and digital photography.

DCF (Design rule for Camera File system)

A standard for image files by the Japan Electronics and Information Technology Industries Association (JEITA).

Depth of field

The subject itself as well as some area to the front and rear of the subject are focused. The entire depth of this focused area, from the front to the rear of the subject, is called "depth of field".

Digital ESP (Electro-Selective Pattern) Light Metering

This determines the exposure by metering and calculating the light levels in the center and other areas of the image separately.

DPOF (Digital Print Order Format)

This is for saving desired print settings on digital cameras. By entering which images to print and the number of copies of each, the user can easily have the desired images printed by a printer or print lab that supports the DPOF format.

Dual Auto Focus

An auto focus system that uses two different focus detection systems in combination. This camera uses the CCD's contrast detection system in combination with the specified sensor's phase difference detection system, nullifying the shortcoming of each system.

Eclipsing (Vignetting)

This refers to when an object obscures part of the field of view so that the whole subject is not photographed. Vignetting also refers to when the image seen through the viewfinder does not exactly match the image shot through the objective lens, so the photographed image includes objects not seen through the viewfinder. In addition, vignetting can occur when an incorrect lens hood is used, causing shadowing to appear in the corners of the image.

EV (Exposure Value)

A system for measuring exposure. EV0 is when the aperture is at F1 and the shutter speed is 1 second. The EV then increases by 1 each time the aperture increases by one F stop or the shutter speed increases by one increment. EV can also be indicated by brightness and ISO settings.

Exposure

The amount of light used to capture an image. The exposure is determined by the time the shutter is open (shutter speed) and the amount of light that passes through the lens (aperture).

Flash Bracket

A mount used to attach an external flash to the camera. Shadows on the subject can be changed by detaching the flash. The flash is used in combination with the flash cable.

ISO

A method for indicating film speed by the International Organization for Standardization (ISO) (e.g. "ISO100"). Higher ISO values indicate greater sensitivity to light, so images can be exposed even in low-light conditions.

JPEG (Joint Photographic Experts Group)

A compression format for still images. Photographs (images) shot using this camera are recorded onto the card in JPEG format when the record mode is set to SHQ, HQ, SQ1 or SQ2. By downloading these images to a personal computer, users can edit them using graphics application software or view the images using an Internet web browser.

M (Manual) Mode

The user sets both the aperture and shutter speed.

NTSC (National Television Systems Committee) / PAL (Phase Alternating Line)

Television formats. NTSC is mainly used in Japan, North America and Korea. PAL is mainly used in Europe and China.

P (Program) Mode

Also called Program AE mode. The camera automatically sets the best shutter speed and aperture for the shot.

Phase-difference Detection System

This system measures the distance to the subject. The distance is calculated by the difference in the image of the subject captured by a pair of sensors.

Pixels

A pixel is the smallest unit (dot) used to make up an image. Clear large-sized printed images require millions of pixels.

Resolution

The size of an image expressed by the number of pixels that make up the image. For instance, a picture taken in 640 × 480 resolution is the same size as the screen when the monitor setting is 640 × 480. However, if the monitor setting is 1024 × 768, the picture only takes up part of the screen.

S (Shutter Priority) Mode

Also called Shutter Priority AE mode. The user selects the shutter speed and the camera automatically varies the aperture so that the picture is taken with the best exposure.

Slave Flash

A wireless flash that is not connected to the camera by a synchronization cord. It flashes in phase with the flash on the camera and can be used for lighting techniques, such as changing the way shadows are cast on a subject.

Sleep Mode

A mode designed to save battery life. The camera automatically enters the sleep mode if you do not operate it for a certain time. To get out of the sleep mode, use any button on the camera (shutter button, arrow pad, etc.).

Synchro Terminals

Terminals on an external flash unit for connecting it to the camera.

TIFF (Tagged Image File Format)

A format used for saving highly detailed black and white or color image data. TIFF image files can be handled by software programs for scanners and graphics applications. This camera uses an uncompressed format.

TFT (Thin-Film Transistor) Color Monitor

















A transistor color monitor constructed using thin-film technology.





















TTL (Through-The-Lens) System





















To help adjust exposure, a light receptor built into the camera directly measures the light passing through the lens.























TTL-AUTO

For use with an external flash. Light emitted by the flash is reflected by the subject and measured by the light receptor in the camera as it passes through the lens. This is used to adjust the external flash intensity.

- 1st curtain  **SLOW1** 61
- 1st curtain with red-eye reduction
  **SLOW1** 62
- 2nd curtain  **SLOW2** 62
- 3:2 103
- A**
- AV OUT jack 9, 134
- AC adapter 19
- AE 223
- AE lock  85
- AE memory  86
- AEL button **AEL** 9, 72, 83, 85
- AF 74, 75, 76, 77, 78
- AF illuminator 9, 78
- AF ILLUMINATOR 78
- AF MODE 74
- AF sensor 9, 76
- AF sequential shooting **AF**  92
- AF target mark 50, 77
- AF/Macro/MF button **AF** /MF
 10, 79, 87, 88
- ALL RESET 145
- All-frame erase  144
- All-frame reservation  178
- Aperture priority shooting **A** 47, 70
- Aperture value 70
- Arrow pad 9, 37, 121
- Auto bracketing **BKT** 93
- Auto focus AF 34
- Auto white balance 109
- Auto-flash 60
- AV cable 134
- B**
- Battery 18
- Battery check 14
- Battery compartment cover .. 10, 18
- Battery compartment lock. ... 10, 18
- BATTERY SAVE 171
- Beep sound  169
- BLACK & WHITE 98
- Bulb shots 72
- C**
- Camera movement warning 50
- CAPTURE 129
- Card 21
- Card access lamp 9, 50
- Card button **CF xD** 9, 23
- Card cover 9, 22
- CARD SETUP 166
- CCD 223
- Center-weighted metering  81
- CF 21, 23
- Charger 17
- Close-up playback **Q** 124
- Cloudy day  110
- Color temperature 110
- Compact Flash 21
- Compression 102
- Connector cover 9, 134, 187
- CONTRAST  115
- Contrast Detection System. ... 76, 223
- Control dial 9, 31, 33, 121, 150
- CONTROL PANEL 163
- COPY 141
- Creating an index 131
- Custom button  10, 154
- CUSTOM BUTTON 154
- Custom white balance 111
- D**
- Date and time  168
- DCF 223
- DC-IN jack 9, 19
- DIAL 150
- Digital ESP Metering 81, 223
- DIGITAL ZOOM 58
- Diopter adjustment ring. 10, 27
- DIRECT 119
- Direct buttons 31

- Direct printing 186
DPOF 176, 223
- E**
- Editing a movie 132
Erase button  9, 143
Error codes 200
EV 224
EV STEP 153
Evening sunlight  110
Exposure 224
Exposure compensation 108
Exposure compensation
 button  10, 108
Exposure differential 72
Exposure Steps 153
External flash 67
- F**
- File name 170
FILE NAME 170
File No. 170
Fill-in flash  61
Flash 9, 59
FLASH  66
Flash charging 60
Flash intensity control 64
Flash intensity control
 button  34
Flash mode 59
Flash mode button  10, 59
Flash off  61
Flash pop-up button  10, 59
Flash stand-by 50
Fluorescent lamp  110
Focus 50, 53, 74
Focus Lock 53
FOCUS MODE 79, 87, 88
FORMAT  166
FRAME ASSIST display 99
FRAME ASSIST shooting  97, 136
- FULLTIME AF 75
Fully 50
FUNCTION 95, 97, 98
- G**
- Green lamp 50
- H**
- Halfway 50
HIGH 102
High speed sequential shooting
 HI  92
Histogram display  119
Histogram target mark 120
Hot shoe 10, 65
HQ 104, 105
HUE  116
- I**
- iESP 74
Index display  125, 126
Information display **INFO** 135
Information display button **INFO**
 10, 135
ISO sensitivity 107, 224
- J**
- JPEG 104, 224
JPEG DUPLICATE SETTING 106
- L**
- Landscape shooting  49
Language   167
Lens 9
Lens cap 16, 25
Lens cap string 16
Lens hood 27
Lithium ion battery 18
- M**
- Macro mode shooting  87

- Manual focus **MF** 79
- Manual shooting **M** 48, 72
- Measurement Unit
m/ft (meters/feet) 173
- Memory gauge 14
- Metering 81
- Metering button  10, 81, 82
- Metering mode 81
- Metering target mark 82
- Microdrive 21
- Microphone 9, 100, 137
- Mode dial 10, 46
- MODE MENU 42
- Monitor 9, 11, 50, 121, 173
- Monitor brightness
 adjustment  173
- Monitor button  9, 50
- MOVIE PLAY 128
- MOVIE PLAYBACK 128
- Movie record  48, 55
- Multi-metering  **MULTI** 83
- My Mode  48, 73
- MY MODE 73
- MY MODE SETUP  160
- N**
- Night Scene shooting  49
- NOISE REDUCTION **NR** 118
- NTSC 174, 224
- Number of storable still pictures 104
- O**
- OK/Menu button  9, 37
- One-touch white balance  111
- Operation sound **BEEP** 148
- Optical zoom 57
- P**
- P-AF 76
- PAL 174, 224
- PANORAMA 95
- PC 175
- Phase difference detection system
 76, 224
- PictBridge 186
- Picture rotation  123
- PIXEL MAPPING 172
- Pixels 224
- Playback mode 13, 41, 44, 121
- Playback on a TV 134
- Portrait shooting  49
- Power battery holder 19
- Power on/off 25
- Power switch 10, 25
- Preset white balance 110
- PRINT 175
- Print button  10, 178
- Print setting 176
- Program shift **Ps** 46
- Program shooting **P** 46
- Protect 142
- Protect button  10, 142
- Q**
- QUICK VIEW 122
- QUICK VIEW button 9, 122
- R**
- RAW 103, 105, 106
- RAW DATA EDIT 140
- REC VIEW 147
- REC. CANCEL 51
- Record mode  102
- Record mode button  10, 105
- Recording sound  100, 101, 137
- Recording sound with
 movies  101
- Recording sound with still
 pictures  100
- Red-eye reduction flash  60
- Remaining recording time 55, 104
- Remote control  90

- Remote control receiver 9, 90
- Resizing  138
- Resolution 102, 225
- Rotation button  10, 123
- S**
- SATURATION  117
- SCENE MODES 117
- Self-timer  89
- Self-timer/Remote control
button  9, 89, 90
- Self-timer/Remote control
lamp 9, 89, 90
- SEPIA 98
- Sequential shooting  92
- SET UP mode 44
- Shade  110
- SHARPNESS  114
- Shoe cover 65
- Shooting mode 11, 40, 42, 46
- SHORT CUT 157
- Shortcut Menus 40
- SHQ 104, 105
- Shutter button 9, 50, 55
- Shutter priority shooting **S** 47, 71
- SHUTTER SOUND 149
- Shutter speed 71
- Single-frame erase  143
- Single-frame reservation  180
- Single-frame shooting  92
- SLAVE 69
- Slave flash 69, 225
- SLEEP 169
- Sleep mode 169, 225
- Slideshow  127
- Slow synchronization
 **SLOW** 61, 63
- Speaker 10
- Sports shooting  49
- Spot (AF mode) 74
- Spot metering  81
- SQ 104, 105
- Standard  **STANDARD** 186
- Strap 16
- Strap eyelet 10, 16
- Sunny day  110
- Super macro MF  88
- Super macro shooting  88
- T**
- Taking still pictures 50
- TIFF 104, 105, 225
- Top menu 37
- Trimming  139, 182, 197
- Tripod socket 10
- Tungsten light  110
- U**
- USB 175
- USB cable 187
- USB connector 9, 187
- V**
- VIDEO OUT 174
- Viewfinder 9, 11, 27, 50, 173
- VOLUME 165
- W**
- White balance **WB** 109
- White balance
adjustment  112
- White balance button **WB** 10, 109
- X**
- xD-Picture Card 21, 23
- Z**
- Zoom lever 10, 57, 124, 125

OLYMPUS®

<http://www.olympus.com/>

OLYMPUS CORPORATION

Shinjuku Monolith, 3-1 Nishi-Shinjuku 2-chome, Shinjuku-ku, Tokyo, Japan

OLYMPUS AMERICA INC.

Two Corporate Center Drive, Melville, NY 11747-3157, U.S.A. Tel. 631-844-5000

Technical Support (USA)

24/7 online automated help: <http://www.olympusamerica.com/support>

Phone customer support: Tel. 1-888-553-4448 (Toll-free)

Our phone customer support is available from 8 am to 10 pm

(Monday to Friday) ET

E-Mail: distec@olympus.com

Olympus software updates can be obtained at: <http://www.olympus.com/digital>

Olympus Europa GmbH

Premises/Goods delivery: Wendenstrasse 14-18, 20097 Hamburg, Germany

Tel: +49 40-23 77 3-0 / Fax: +49 40-23 07 61

Letters: Postfach 10 49 08, 20034 Hamburg, Germany

European Technical Customer Support:

Please visit our homepage <http://www.olympus-europa.com>

or call our TOLL FREE NUMBER* : **00800 - 67 10 83 00**

for Austria, Belgium, Denmark, Finland, France, Germany, Italy, Luxemburg, Netherlands, Norway, Portugal, Spain, Sweden, Switzerland, United Kingdom

* Please note some (mobile) phone services/provider do not permit access or request an additional prefix to +800 numbers.

For all not listed European Countries and in case that you can't get connected to the above mentioned number please make use of the following

CHARGED NUMBERS: **+49 180 5 - 67 10 83** or **+49 40 - 237 73 899**

Our Technical Customer Support is available from 9 am to 6 pm MET (Monday to Friday)

CAMEDIA

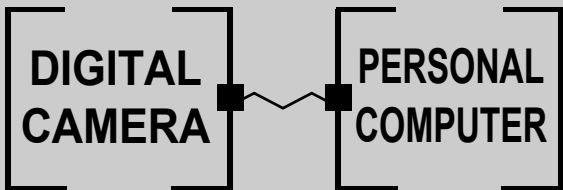

DIGITAL CAMERA — PC CONNECTION
OPERATION MANUAL

How to use your PC to get the most from images taken with your digital camera.

- Thank you for purchasing an Olympus digital camera.
- This manual provides instructions on how to install the USB driver. To ensure correct installation, refer only to these installation procedures.

Introduction

This manual explains in detail how to connect your Olympus digital camera to a computer. Read it carefully and keep it in a safe place for future reference.

About this manual

- The information contained in this manual may be subject to change without notice. For the latest information on the product, please consult your local Olympus representative.
- The information contained in this manual has been compiled by taking all possible measures to ensure its accuracy. However, if you find any errors or incomplete information, please contact your local Olympus representative.
- It is prohibited by copyright laws to duplicate in part or in whole the information contained in this manual, except for personal use. Reproduction without permission of the copyright owner is prohibited.
- The PC screens shown in this manual may differ slightly from the actual displays on some PC models.

Trademarks

- Microsoft and Windows are registered trademarks of Microsoft Corporation.
- Macintosh is a trademark of Apple Computer Inc.
- All other company and product names are registered trademarks and/or trademarks of their respective owners.

INDEX

Flowchart 4

Identifying the OS 6

Windows (98/Me/2000/XP) 8

Windows

Macintosh (OS 9/X). 23

Macintosh

**Downloading image files using other OS
(For other OS users). 31**

Flowchart

By connecting the camera to a computer with the provided USB cable, images on a card can be transferred to the computer. Some OS's (operating systems) may need a special setup before connecting to the camera for the first time. Follow the chart below.

For details, see the Olympus Corporate Site or phone customer support.

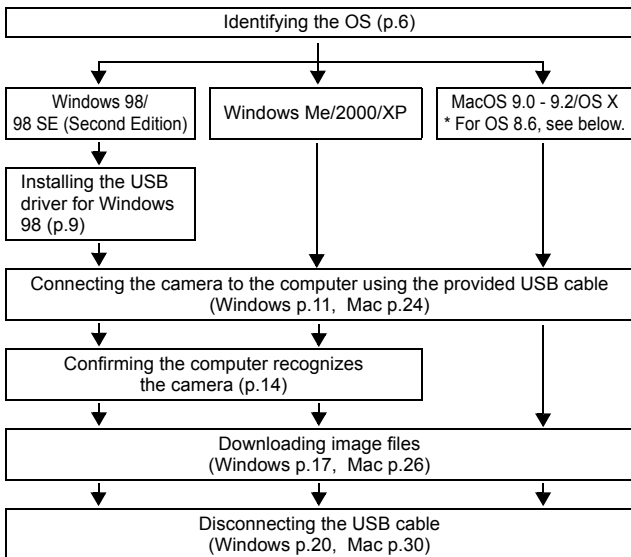

* Even if your computer has a USB connector, data transfer may not function correctly if you are using one of the operating systems listed below or if you have an add-on USB connector (extension card, etc.).

- Windows 95/NT 4.0
- Windows 98/98 SE upgrade from Windows 95
- Mac OS 8.6 or lower (except Mac OS 8.6 equipped with USB MASS Storage Support 1.3.5 installed at the factory)
- Data transfer is not guaranteed on a home-built PC system or PCs with no factory installed OS.



- When connecting the camera to the computer, make sure that there is sufficient remaining battery power. When connected (transmitting) to the computer, the camera does not enter the sleep mode nor will the camera's power turn off automatically. Depending on the camera model, when the battery power runs out or the internal temperature rises, the camera may stop operating automatically. This could cause the computer to malfunction, and any image data (file) being transmitted may be lost. Be careful when downloading files for a long period of time. Use the AC adapter (optional) when downloading files.
- If you connect or disconnect the AC adapter when the camera is connected to the computer and is running on battery power, it may result in the loss of image data on the card or cause a malfunction in the computer. Before connecting or disconnecting the AC adapter, disconnect the camera from the computer and make sure that the camera is turned off.
- To avoid computer malfunctions, do not turn off the camera when the camera is connected to a computer.
- If the camera is connected to the computer via a USB hub, operation may not be stable if there are any compatibility problems between the computer and the hub. In such cases, do not use the hub and connect the camera directly to the computer.



- You can view images using: graphics applications that support the JPEG file format (Paint Shop Pro, Photoshop, etc.); Internet browsers (Netscape Communicator, Microsoft Internet Explorer, etc.); CAMEDIA Master software; or other software. For details on using commercial graphics applications, refer to their instruction manuals.
- QuickTime is needed for playing back movies. QuickTime is included on the provided software CD.
- If you want to process images, make sure to download them to your computer first. Depending on the software, image files may be destroyed if the images are processed (rotated, etc.) while they are on the card.

Identifying the OS

Identify the OS on your computer before connecting the camera. How to identify the OS depends on the computer.

● Windows

- 1 Double-click the “My Computer” icon on your desktop.

When the “My computer” icon is not on your desktop, click “Control Panel” from the “Start” menu.

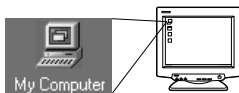

- 2 Double-click the “Control Panel” icon.



- 3 Double-click the “System” icon.



The way the file icons inside the folder appear may vary depending on your version of Windows. If you don't see the icon you are looking for, click on “view all Control Panel options” on the left of the window.

4 A System Properties window will appear. Note and record the “System:” information.

Confirm that your system is Windows 98, 98 SE, Me, 2000 Professional or Windows XP, then press “OK” to close the window.



If your OS is Windows 98/98 SE, proceed to “Installing the USB driver for Windows 98” (👉 p.9).

Users running Windows Me/2000/XP 👉 p.11

Users running other OS 👉 p.31

● Mac OS (Macintosh)

Select “About This Computer” from the Apple menu on the menu bar.

A window appears with the name of the computer’s OS.

Confirm that the OS is OS 9.0-9.2 or OS X.

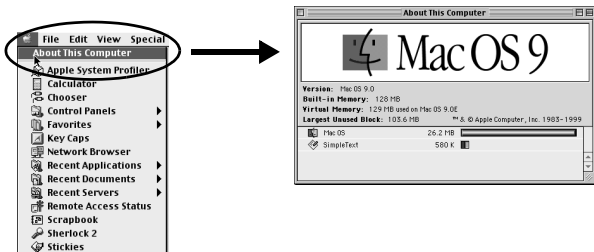

Users running Mac OS 9/X 👉 p.23

Users running other OS 👉 p.31

Windows

Using Windows 98/Me/2000/XP

Make sure that:

- Your computer is turned on and Windows is running.
- If you are running any applications, quit them all.
- You are recommended to power the camera using the optional AC adapter. If the battery power runs out while the computer is accessing the card in the camera, the camera will turn off in the middle of the operation and this could destroy image files (data). If you are using batteries, make sure that there is sufficient remaining battery power.

Installing the USB driver for Windows 98 (When using Windows 98/98 SE)	9
Connecting the camera to the computer	11
Confirming the computer recognizes the camera	14
Confirming the USB driver is installed	15
Downloading images to your computer.....	17
Disconnecting the camera from your computer	20

Installing the USB driver for Windows 98 (When using Windows 98/98 SE)

If your OS is Windows 98/98 SE, you must install the USB driver. Follow the instructions below to install the USB driver in your computer. Once it is fully installed, you do not need to repeat the procedure again.

If your OS is Windows Me/2000/XP, you do not need to install the USB driver. Proceed to “Connecting the camera to the computer” (👉 p.11).

- 1** Insert the provided software CD into your CD-ROM drive.

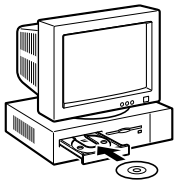

- 2** The Olympus Windows Installer should automatically launch. Click “USB Driver”.

If the USB driver is already installed in your computer, this option will not appear.

- This option will not appear if you are using Windows Me/2000/XP.



If the installer is not automatically launched, select “Run..” on the “Start” menu and then execute “(drive letter):/ Information.exe”.



The drive letter of the CD-ROM varies depending on the computer.
To identify the drive letter, double-click “My Computer” on the desktop.

- 3** Click “Continue”. The installation of the USB driver will start.



- 4** Click “OK” to restart your computer and the installation is complete.

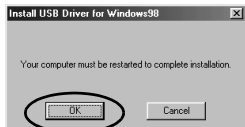

- 5** When the computer has restarted, installation is complete. If the Olympus Windows Installer screen appears, click “Close” and remove the CD-ROM from the CD-ROM drive.

Connecting the camera to the computer

Users running Windows 98/98SE need to install the USB drive before connecting the camera to your computer for the first time. (☞ p.9)

- 1** Some camera models have a “USB” setting in the menu. Make sure that “PC” is selected before connecting. This is not required if your camera does not have this setting. For details on how to operate the menu, refer to your camera's reference manual.

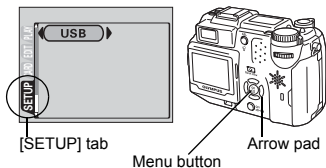

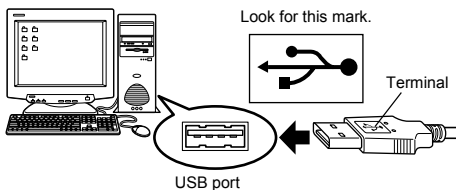

- 2** Insert the marked end of the provided USB cable into the USB port on your computer as shown below.



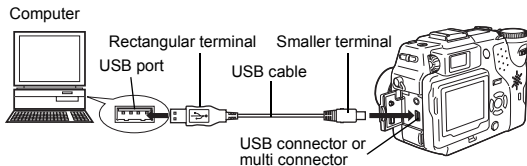

The location of the USB port varies depending on the computer. For details, refer to your computer's manual.

- 3** After making sure that the camera is turned off, connect the end of the USB cable to the USB connector on the camera. The location of the USB connector or multi connector varies depending on the camera model. Refer to the camera manual for details.



4 Turn the camera on in  (playback) mode.

- Most cameras with a lens barrier turn on automatically in Step 3, with the exception of some models which require you to press the  (monitor) button or  button.

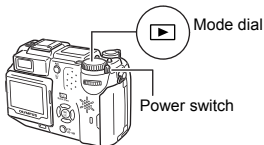
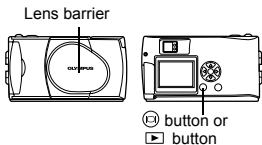

5 When the screen shown right appears on the monitor in Step 4, use the arrow pad to select “PC” and press the OK button.

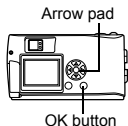
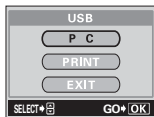

6 The computer recognizes the camera as a new device.

- Depending on the camera model, when you connect the camera to the computer, the lamp on the right of the viewfinder or the self-timer lamp may light.

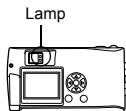

When you connect the camera to the computer for the first time, the computer automatically recognizes the camera. Click “OK” when the message saying that the installation is completed appears. The computer recognizes the camera as a “Removable Disk”.

● **Windows XP**

You can download image files from the camera easily. Select "Copy pictures to folder on my computer using Microsoft Scanner and Camera Wizard", then follow the on-screen instructions. You may also select "take no action" to bypass the Microsoft Scanner and Camera Wizard. You may then use a more advanced image viewing/editing program such as Olympus CAMEDIA Master software. For detailed instructions on downloading, refer to the CAMEDIA Master software user's guide.



When the camera is connected to the computer, none of the camera buttons are functional.

Confirming the computer recognizes the camera

1 Double-click the “My Computer” icon on the desktop.

For users running Windows XP, click “My Computer” from the “Start” menu.

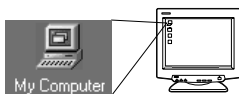

2 Make sure the “Removable Disk” icon appears in the window.

There may already be other “Removable Disk” icons for other devices, such as a removable media drive or USB SmartMedia Reader/Writer. In this case, the digital camera is recognized as another “Removable Disk”.

If you cannot find the icon, the camera and computer are not connected properly. Turn the camera off, disconnect the camera from the computer and connect again, or proceed to “Confirming the USB driver is installed” (p.15) to make sure that the USB driver is fully installed.

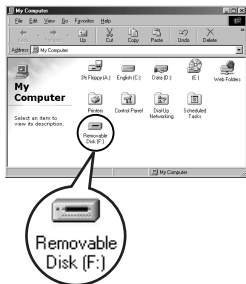

Confirming the USB driver is installed

If the computer does not recognize the camera as a Removable Disk, follow the procedure below to check whether the USB driver has been fully installed.

- 1** Open “My Computer” and double-click the “Control Panel” icon.
For users running Windows XP, open “Control Panel” from the “Start” menu.



- 2** Double-click the “System” icon.

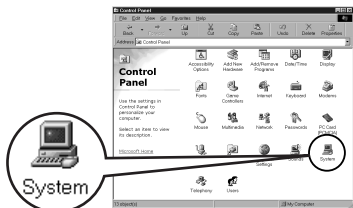

- 3** The System window will appear. Click the “Device Manager” tab.

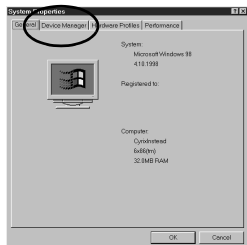

4 Confirm that “OLYMPUS Digital Camera” is in the “Universal Serial Bus Controller” category.

If you cannot find the “OLYMPUS Digital Camera”, turn the camera off, disconnect the camera from the computer and start again.

Users running Windows 98/98 SE start again from “Confirming the USB driver is installed”, and Users running Windows Me/2000/XP start from “Connecting the camera to the computer”.

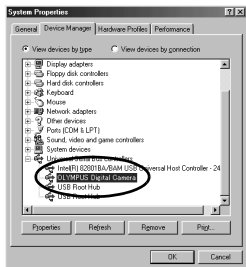

If the USB driver was successfully installed, you can find the following in the “Device Manager”.

- the name of the camera you have connected listed under “Disk drives”
- “OLYMPUS Digital Camera” listed as one of the items in the “Universal Serial Bus Controller” category

Downloading images to your computer

1 Double-click the “My Computer” icon on the desktop.

For users running Windows XP, click “Control Panel” from the “Start” menu.

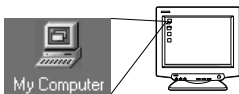

2 Double-click the “Removable Disk” icon.

A new “Removable Disk” icon appears when the camera is connected to the computer, as the digital camera is recognized as a “Removable Disk”.

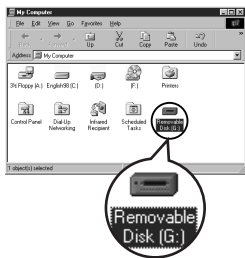

If an error message appears when you double-click the icon, there may be a problem with one of the following:

- ① the camera's power source (the AC adapter is not properly connected or the battery power is low)

Make sure that the AC adapter is correctly connected or that the batteries are not running low.

- ② the card (there is no card in the camera or there is a problem with the card)

Check that you can play back pictures stored on the card on the monitor of your digital camera.

3 Double-click the “Dcim” folder.

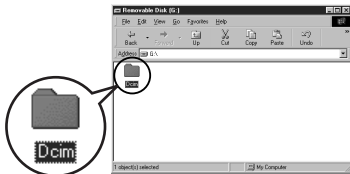

4 Double-click the “100olymp” folder.

Image files (JPEG files) with file names such as “P1010001.jpg” are displayed.

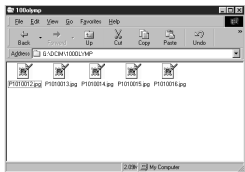

- The camera automatically assigns folder names and file names according to the following rules.

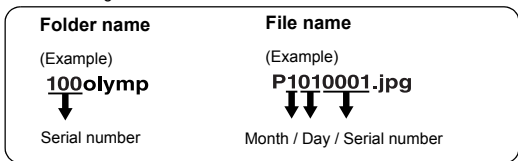

- Serial numbers of image files run from 0001 to 9999.
- Serial numbers of folders run from 100 to 999.
- When file number 9999 is reached, a new folder is created and assigned the next number.
- Months January through September are expressed by the numbers 1 through 9, October by the letter A, November by B and December by C.

5 Double-click the “My Documents” icon on the desktop.

If you cannot find the icon on the desktop, select “Explorer” on the Start menu and double-click the “My Documents” icon.

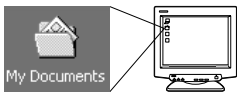

The “My Documents” window is displayed.



6 Drag & drop the image you want to save in the computer (in this case, P1010012.jpg) to the “My Documents” window.

The image is saved in the computer (in My Documents folder).

- To select all files, choose Edit > Select all.

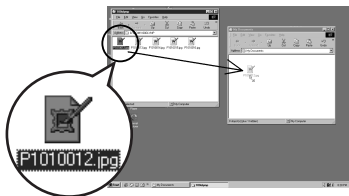

When the image file has been downloaded to the computer, you can view images by double-clicking the image files downloaded to your computer. The files will be opened in the default image viewer of the operating system. If you want to view the image a different size or process it, you will need to open the image with software that supports JPEG or TIFF images files, such as Paint Shop Pro, Photoshop or CAMEDIA Master software.



The lamp on the right of the viewfinder or the card access lamp blinks while the image is being copied. Never open the card cover on the camera, load or remove the batteries, or connect or disconnect the AC adapter while the lamp is blinking as the image files may be destroyed.

Disconnecting the camera from your computer

If your OS is Windows Me/2000, proceed to “Windows Me/2000/XP” (p.21).

● Windows 98

- 1** Make sure that the lamp on the right of the viewfinder or the self-timer lamp (which on some models light while the camera is connected to the computer) or the card access lamp is not blinking. The lamps and their location vary depending on the model. Refer to your camera's reference manual.

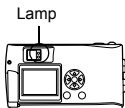

Card access lamp

- 2** Double-click the “My Computer” icon and right-click the “Removable Disk” to display the menu.



Removable
Disk (F:)

- 3** Click “Eject” on the menu.



- 4** Make sure that the lamp on the right of the viewfinder or the self-timer lamp (which on some models light while the camera is connected to the computer) or the card access lamp is not blinking.

Depending on the camera model, the green lamp may light or lamps that were lit while the camera was connected to the computer may go off. If the lamp is not flashing, then the cable can be removed.

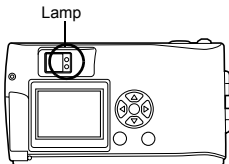

- 5** Remove the USB cable from the camera.

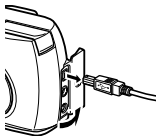

- 6** Remove the USB cable from your computer.

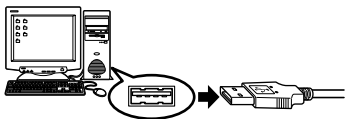

● Windows Me/2000/XP

- 1** Make sure that the lamp on the right of the viewfinder or the self-timer lamp (which on some models light while the camera is connected to the computer) or the card access lamp is not blinking.

The lamps and their location vary depending on the model. Refer to your camera's reference manual.

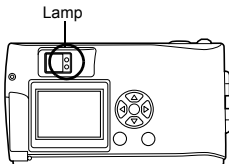

- 2 Click the  “Unplug or Eject Hardware” icon on the task bar.

The message saying that the drive has been stopped appears.

- 3 Click on the message.

The “Unplug or Eject Hardware” window appears.

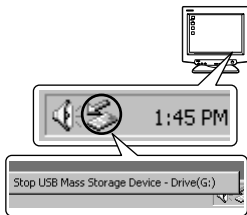

- 4 When a message appears, click “OK”.



- 5 Remove the USB cable from the camera.

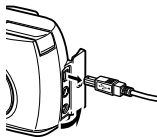

- 6 Remove the USB cable from your computer.

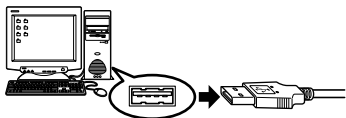

Caution

If the window returns the following message when you click “Unplug or Eject Hardware”, first make sure that no image data is being downloaded from the camera, and then remove the USB cable.



Macintosh

Using Mac OS (9/X)

Make sure that:

- Your computer is turned on and Mac OS is running.
- If you are running any applications, quit them all.
- You are recommended to power the camera using the optional AC adapter. If the battery power runs out while the computer is accessing the card in the camera, the camera will turn off in the middle of the operation and this could destroy image files (data). If you are using batteries, make sure that there is sufficient remaining battery power.

If you are running Mac OS X, the connection to the computer and downloading the image data are verified. Restrictions such as the following may occur due to the OS.

- The image file properties are not displayed correctly.
- Images in the camera cannot be opened without first downloading them. etc.

For more details, visit the Olympus web site.

Connecting the camera to the computer	24
Downloading images to your computer.....	26
Disconnecting the camera from your computer	30

Connecting the camera to the computer

- 1** Some camera models have a “USB” setting in the menu. Make sure that “PC” is selected before connecting. This is not required if your camera does not have this setting. For details on how to operate the menu, refer to your camera's reference manual.

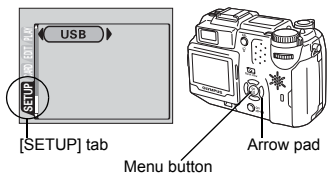

- 2** Insert the marked end of the USB cable into the USB port on your computer as shown below.

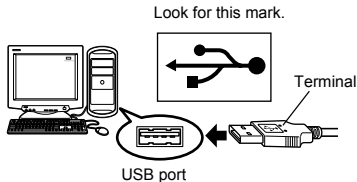

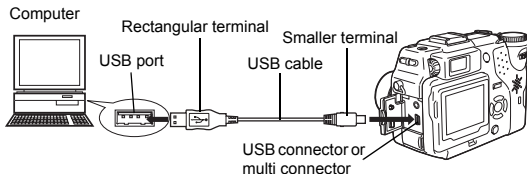

The location of the USB port varies depending on the computer. For details, refer to your computer's manual.

- 3** After making sure that the camera is turned off, connect the end of the USB cable to the USB connector on the camera. The location of the USB connector or multi connector varies depending on the camera model. Refer to the camera manual for details.



4 Turn the camera on in (playback) mode.

- Most cameras with a lens barrier turn on automatically in Step 3, with the exception of some models which require you to press the  (monitor) button or  button.

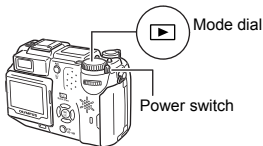
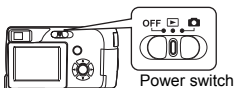
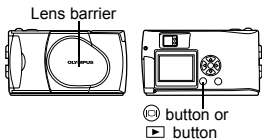

5 When the screen shown right appears on the monitor in Step 4, use the arrow pad to select "PC" and press the OK button.

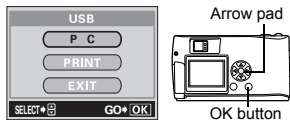

6 The computer recognizes the camera as a new device.

- Depending on the camera model, when you connect the camera to the computer, the lamp on the right of the viewfinder or the self-timer lamp may light.

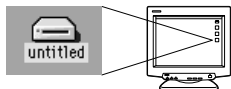

The computer recognizes the camera automatically and an "Untitled" icon appears on the desktop. If you cannot find this icon, turn off the camera and connect again.

• Mac OS X

When the computer has recognized the camera, the Apple Image Capture software automatically launches.  p.29



When the camera is connected to the computer, none of the camera buttons are functional.

Downloading images to your computer

● Mac OS 9

You can download images from the camera and save them in your computer (in this case, in the Hard Disk).

- 1 Double-click the “Untitled” icon displayed on the desktop when the camera is connected to the computer.**

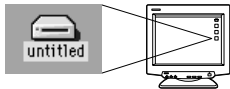

If you cannot find this icon, or if an error message appears when you double-click the icon, there may be a problem with one of the following:

- ① the camera's power source (the AC adapter is not properly connected or the battery power is low)
- ② the card (there is no card in the camera or there is a problem with the card)
Check that you can play back pictures on the monitor of your camera.
- ③ the USB cable (the camera is not properly connected to the computer by the USB cable).
- ④ Apple "File Exchange" extension is not enabled.
 - Please refer to your Apple operating system manual for instructions on how to enable this extension.

- 2 Double-click the “Dcim” folder.**

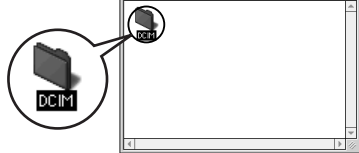

- 3 Double-click the “100OLYMP” folder.**

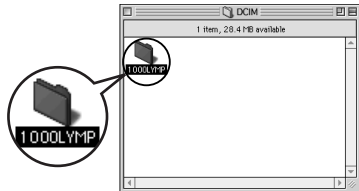
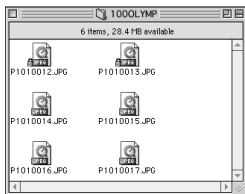
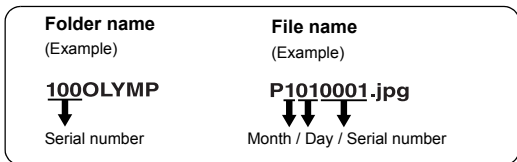

Image files (JPEG files) with file names such as “P1010001.JPG” are displayed.



- The camera automatically assigns folder names and file names according to the following rules.



- Serial numbers of image files run from 0001 to 9999.
- Serial numbers of folders run from 100 to 999.
- When file number 9999 is reached, a new folder is created and assigned the next number.
- Months January through September are expressed by the numbers 1 through 9, October by the letter A, November by B and December by C.

Macintosh

4 Double-click the “Macintosh HD” icon on the desktop.

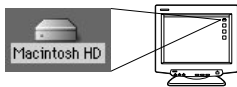

The “Hard Disk” window is displayed.

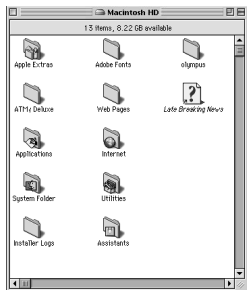

5 Drag & drop the image you want to save in the computer (in this case, **P1010012.JPG**) to the “Hard Disk” window.

The image is saved in the computer (in the Hard disk).

- To select all images, click Edit > Select all.

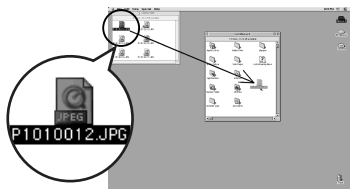

When the image file has been copied to the computer, you can view images by double-clicking the image files in the “Hard Disk” folder. The files will be opened in the default image viewer of the operating system. If you want to view the image a different size or process it, you will need to open the image with software that supports JPEG or TIFF images files, such as Paint Shop Pro, Photoshop or CAMEDIA Master software.



The lamp on the right of the viewfinder or the card access lamp blinks while the image is being copied. Never open the card cover on the camera, load or remove the batteries, or connect or disconnect the AC adapter while the lamp is blinking as the image files may be destroyed.

● Mac OS X

Malfuncions such as the following may occur due to the OS.

- If the camera is not connected correctly, a malfunction occurs in the computer.
- Date and time information of image files is not accurately displayed.
- If the card cover of the camera is opened while connecting to the computer, the “untitled” icon does not disappear from the desktop, etc.

When the computer has recognized the camera, the Apple Image Capture software dialog appears.

1 From the “Download To” menu, select a destination folder.

2 To download all images, click “Download All”.
To selectively download images, click “Download Some” and highlight the desired images.



The images are transferred from the camera to your computer.



If you are operating Mac OS X and you want to download images using the same procedure as for Mac OS 9, select “File > Close” and exit the Apple Image Capture software. At this time, the camera is indicated as “unlabeled”.



If you use the Apple Image Capture software, images downloaded to your computer and transferred back to a card may not play back on the camera or may have other problems.

Disconnecting the camera from your computer

- 1** Make sure that the lamp on the right of the viewfinder or the self-timer lamp (which on some models light while the camera is connected to the computer) or the card access lamp is not blinking.

The lamps and their location vary depending on the model. Refer to your camera's reference manual.

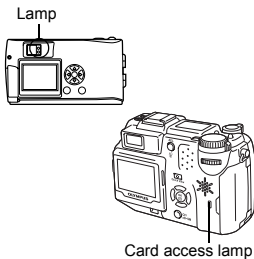

- 2** Drag the "untitled" icon on the desktop to "Trash".



- 3** Make sure that the lamp on the right of the viewfinder or the self-timer lamp (which on some models light while the camera is connected to the computer) or the card access lamp is not blinking.

Depending on the camera model, the green lamp may light or lamps that were lit while the camera was connected to the computer may go off. If the lamp is not flashing, then the cable can be removed.

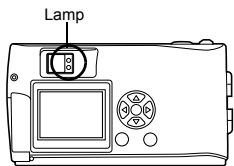

- 4** Remove the USB cable from the camera.

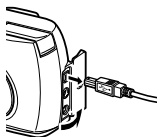

- 5** Remove the USB cable from your computer.

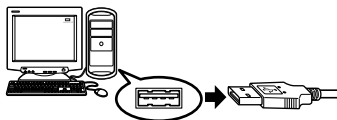

Downloading image files using other OS

(For other OS users)

Users running other OS cannot connect the camera directly to a computer.

- **Windows 95**
- **Windows NT**
- **Mac OS before OS 9**

For an OS listed above, you can download images directly to your computer using an optional floppy disk adapter or PC card adapter.

For details, see the Olympus Corporate Site or phone customer support.

Does your computer have a USB interface?
Is there a port marked  on your computer?

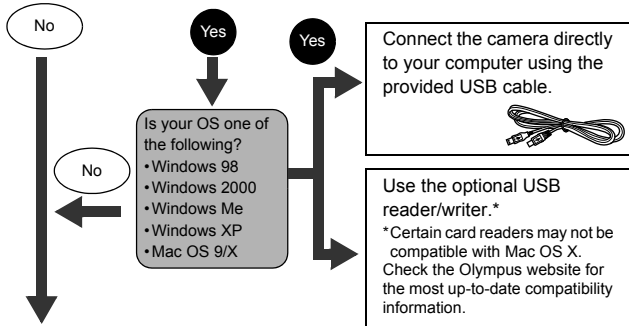

Does your computer have a built-in PC card slot?

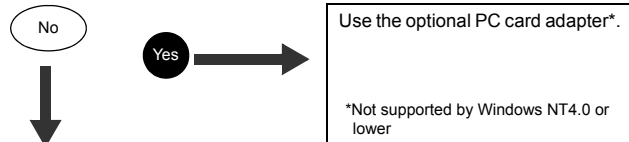

Consult your nearest Olympus representative.

OLYMPUS®

<http://www.olympus.com/>

OLYMPUS CORPORATION

Shinjuku Monolith, 3-1 Nishi-Shinjuku 2-chome, Shinjuku-ku, Tokyo, Japan

OLYMPUS AMERICA INC.

Two Corporate Center Drive, Melville, NY 11747-3157, U.S.A. Tel. 631-844-5000

Technical Support (USA)

24/7 online automated help: <http://www.olympusamerica.com/support>

Phone customer support: Tel. 1-888-553-4448 (Toll-free)

Our phone customer support is available from 8 am to 10 pm

(Monday to Friday) ET

E-Mail: distec@olympus.com

Olympus software updates can be obtained at: <http://www.olympus.com/digital>

Olympus Europa GmbH

Premises/Goods delivery: Wendenstrasse 14-18, 20097 Hamburg, Germany

Tel: +49 40-23 77 3-0 / Fax: +49 40-23 07 61

Letters: Postfach 10 49 08, 20034 Hamburg, Germany

European Technical Customer Support:

Please visit our homepage <http://www.olympus-europa.com>

or call our TOLL FREE NUMBER* : **00800 - 67 10 83 00**

for Austria, Belgium, Denmark, Finland, France, Germany, Italy, Luxemburg, Netherlands, Norway, Portugal, Spain, Sweden, Switzerland, United Kingdom

* Please note some (mobile) phone services/provider do not permit access or request an additional prefix to +800 numbers.

For all not listed European Countries and in case that you can't get connected to the above mentioned number please make use of the following

CHARGED NUMBERS: **+49 180 5 - 67 10 83** or **+49 40 - 237 73 899**

Our Technical Customer Support is available from 9 am to 6 pm MET (Monday to Friday)