

OLYMPUS®

DIGITAL CAMERA

FE-130/X-720/X-740 FE-140/X-725

Advanced Manual

Detailed explanations of all the functions for getting the most out of your camera.

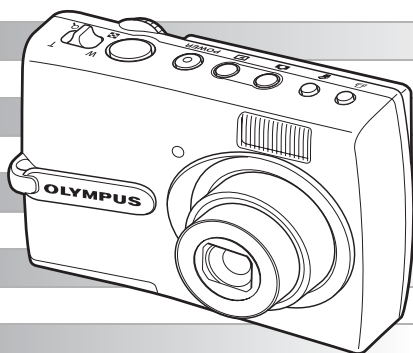

- Thank you for purchasing an Olympus digital camera. Before you start to use your new camera, please read these instructions carefully to enjoy optimum performance and a longer service life. Keep this manual in a safe place for future reference.
- We recommend that you take test shots to get accustomed to your camera before taking important photographs.
- In the interest of continually improving products, Olympus reserves the right to update or modify information contained in this manual.
- The images of the LCD screen and illustrations of the camera used in this manual may differ from the actual product. For this manual, all of the images are based on the FE-130/X-720/X-740 model.

How to use this manual

Search for a topic ▶▶▶ Table of Contents



 P. 3

Contents

How to use this manual	2
Contents	3

1 Button operations 8















Test out the functions of the camera buttons by following the illustrations and actually trying them out on the camera.

POWER button	Turning the camera on and off	8
Shutter button	Shooting picture	8
 button (Playback).....	Switching playback mode/Turning the camera on and off	9
 button (Shooting).....	Switching shooting mode	9
Mode dial	Switching shooting mode	9

Search for a term ▶▶▶ Index

 P. 77

Index

 button (Erase)	13	Card access lamp	50, 60, 73
 button (Exposure compensation)	12	CCD	30, 67
 button (Flash mode)	13	Close-up playback 	11
 button (Macro)	12	COLOR	30
 button (OK)	12	Compression	20
 button (Playback mode)	9	Connector cover	31, 33, 48
 button (Print)	13, 34	Cover lock	72
 button (Self-timer)	13	CUISINE 	21
 button (Shooting mode)	9	CUSTOM PRINT	35
A		D	
AC adapter	73	D IMAGE STABILIZATION 	10
ALL ERASE 	25	Date and time 	30
ALL INDEX	25	DCF	67
		DIGITAL ZOOM	40

Search by Objective ▶▶▶ Shooting tips and information

 P. 55

5 Getting to know your camera better

Shooting tips and information

Tips before you start taking pictures

The camera does not turn on even when a battery is loaded

The batteries are loaded incorrectly

- Reload the batteries correctly.

The batteries are exhausted

- Replace the batteries with new ones, or charge the batteries.

The battery is temporarily unable to function because of the cold

















- Battery performance declines in low temperatures, and the charge may not be sufficient to turn on the camera. Remove the battery and warm it by putting it in your pocket for a while.

Contents

How to use this manual.....	2
Contents.....	3





1 Button operations 8



Test out the functions of the camera buttons by following the illustrations and actually trying them out on the camera.

POWER button	Turning the camera on and off	8
Shutter button	Shooting picture	8
 button (Playback).....		
Switching to playback mode/Turning the camera on and off		9
 button (Shooting).....	Switching to shooting mode	9
Mode dial	Switching shooting mode	9
AUTO	Shooting still picture	9
 , SCN		
Shooting pictures by selecting a scene according to the situation		9
	Shooting pictures using image blur reduction	10
	Recording movie	10
GUIDE	Following shooting guide to set	10
Zoom lever.....	Zooming while shooting/close-up playback	11
MENU button	Displaying the top menu	12
Arrow pad ( /  /  / ).....		12
 button		12
 button.....	Changing picture brightness	12
 button	Shooting pictures close to the subject	12
 button.....	Self-timer shooting	13
 button.....	Flash shooting	13
 button	Erasing pictures	13
 button.....	Printing	13
DISP./? button.....		
Changing the information display/Displaying the menu guide		14

2 Menu operations 15

Learn everything about the menus, from basic operations to the functions of each menu and their various settings.

About the menus	15
Using the menus.....	16
Shooting mode menu	18
CAMERA MENU	18
DIGITAL ZOOM	Zooming in on your subject 18
PANORAMA	Creating a panoramic picture 19
IMAGE QUALITY	Changing the image quality 20
RESET	Resetting the settings to the default 20
SCN (Scene).....	
Shooting pictures by selecting a scene according to the situation	21
Playback mode menu	22
PLAYBACK MENU	22
	Protecting pictures 22
	Rotating pictures 23
SLIDESHOW	Playing back pictures automatically 23
MOVIE PLAY	Playing back movies 24
CALENDAR	Playing back pictures in a calendar 25
INDEX.....	Viewing the pictures as an index 25
ERASE.....	Erasing pictures 25
SEL. IMAGE.....	Erasing selected picture 25
ALL ERASE	
Erasing all pictures in the internal memory or on the card	25
EDIT.....	Editing still pictures 26
	Reducing the size of picture 26
	Zooming in the part of pictures 26
REDEYE FIX.....	Fixing the red-eye in pictures 26
BLACK & WHITE	Changing pictures to black and white 26
SEPIA	Changing pictures to a sepia tone 26
FRAME	Adding frames to the pictures 26
TITLE	Adding titles to the pictures 27
CALENDAR	Adding calendars to the pictures 27
LAYOUT.....	Arranging and combining multiple pictures 27
BRIGHTNESS.....	Changing brightness of the pictures 28
SATURATION.....	Changing color strength of the pictures 28
PRINT ORDER	Making print reservations (DPOF) 28

SETUP menu	29
MEMORY FORMAT (FORMAT)	
Formatting the internal memory or card	29
BACKUP	Copying pictures in the internal memory to the card 29
	Selecting a display language 29
COLOR	Setting the color of the menu screens 30
PIXEL MAPPING	Adjusting the image processing function 30
	Adjusting the monitor brightness 30
	Setting the date and time 30
VIDEO OUT	Playing back pictures on a TV 31

3 Printing pictures32

Learn how to print pictures you have taken.

Direct printing (PictBridge)	33
Using the direct printing function	33
Printing pictures	33
Other print modes and print settings (CUSTOM PRINT)	35
Print settings (DPOF)	39
How to make print reservations	39
Single-frame reservation	40
All-frame reservation	41
Resetting print reservation data	42

4 Connecting the camera to a computer43

Learn how to transfer pictures to a computer and save them.

Flow	43
Using OLYMPUS Master	43
What is OLYMPUS Master?	43
Install the OLYMPUS Master software	44
Connecting the camera to a computer	48
Start up the OLYMPUS Master software	49
Displaying camera images on a computer	50
Downloading and saving images	50
Viewing still pictures and movies	52
Printing pictures	53

To download and save images to a computer without using OLYMPUS Master	54
---	----

5 Getting to know your camera better 55

Find out more about your camera and learn what to do when you have a question regarding operations.

Shooting tips and information	55
Tips before you start taking pictures	55
The camera does not turn on even when a battery is loaded	55
No picture is taken when the shutter button is pressed	55
The time and date have not been set	56
Shooting tips	56
Focusing on the subject	56
Subjects that are difficult to focus on	57
Taking pictures without blurring	57
Taking pictures without the flash	58
The picture is grainy	58
Taking pictures of a white beach or snow scene	58
Taking pictures of a subject against backlight	58
Additional shooting tips and information	59
Increasing the number of pictures that can be taken	59
Using a new card	60
Lamp indicators	60
Extending the useful life of the battery	60
Functions that cannot be selected from menus	61
Selecting the optimal image quality	61
Setting the current camera settings to its default	61
Playback tips	62
Playing back the pictures stored in the internal memory	62
Understanding the settings and other information of pictures taken	62
Quickly displaying a desired picture	62
Viewing pictures on a computer	62
Viewing the entire picture on a computer screen	62
When you get an error message on the camera	63
Functions available in shooting modes and scenes	65
Glossary of terms	67

6 Miscellaneous 69

Read about convenient functions and safety precautions on how to use your camera more effectively.

Camera care	69
The battery	70
Useful use of the accessories	71
The card	71
AC adapter	73
Safety Precautions	74
Index	77

1 Button operations

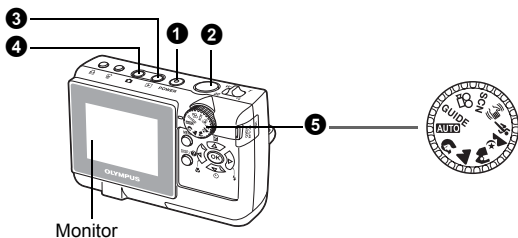

1 POWER button

Turning the camera on and off







Power on: The camera turns on in shooting mode.

- Monitor turns on
- Lens extends

2 Shutter button

Shooting picture

Shooting still picture

Set the mode dial to **AUTO**, , , , , , , **SCN** and lightly press the shutter button (halfway). The green lamp lights when the focus and exposure are locked (focus lock). Now press the shutter button all the way (fully) to shoot a picture.

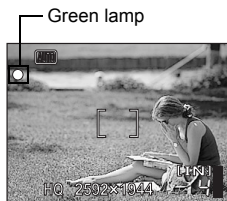



Locking the focus and then composing the shot (focus lock)

Compose your picture with the focus locked, and then fully press the shutter button to shoot a picture.

- When the green lamp blinks, the focus is not adjusted properly. Try locking the focus again.

Recording movie

Set the mode dial to , and then press the shutter button fully to start recording. Press the shutter button again to stop recording.

3  **button (Playback)** Switching to playback mode/Turning the camera on and off

The camera switches to playback mode. The last picture taken is displayed.

- Press the arrow pad to view other pictures.
- Use the zoom lever to switch between close-up playback, index display and calendar display.

 “MOVIE PLAY Playing back movies” (P.24)

When you press the  button while the camera is turned off, the camera will be turned on in playback mode. If you press the button again, the camera will be turned off.

4  **button (Shooting)** Switching to shooting mode

The camera switches to shooting mode.

5 **Mode dial** Switching shooting mode

Set the mode dial to the desired mode to shoot.

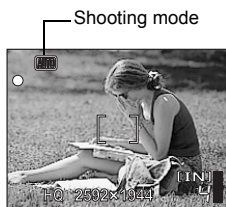
**AUTO** Shooting still picture





The camera determines the optimum settings and shoots the picture.

 **SCN** Shooting pictures by selecting a scene according to the situation

The scene selection screen displays sample images and the shooting mode to best suit the situation.

Selecting another scene

There are two ways to select another scene.

- Turn the mode dial to set to any of the following modes: , , , , .
- Set the mode dial to **SCN**, and press the **MENU** button to select [SCN] and select the other scene.
- If switching to the other scene, the settings of each scene will return to default except a few settings.

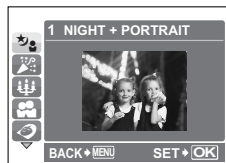

 “SCN (Scene) Shooting pictures by selecting a scene according to the situation.” (P.21)

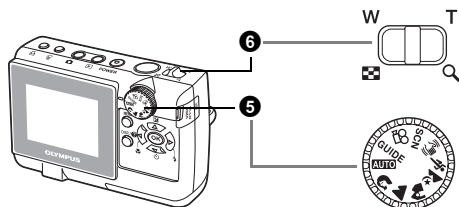

Shooting pictures using image blur reduction

This function reduces the blur incurred by a moving subject or camera movement when taking pictures.

Recording movie

The camera switches to the movie recording mode. Audio recording is not available.

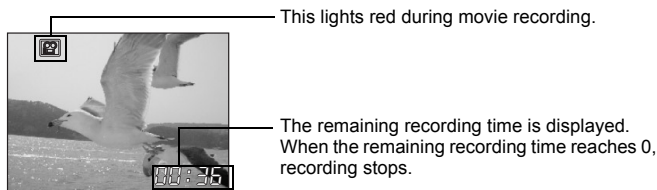

GUIDE Following shooting guide to set

You can set the desired setting following the shooting guide displayed on the monitor.

- Press the **MENU** button to display the shooting guide again.
- When you change the camera setting or playing back images without using the shooting guide, set the mode dial other than **GUIDE** to cancel the shooting guide function first.
- When you press the **MENU** button or change the mode dial, previously set the shooting guide setting returns to default.

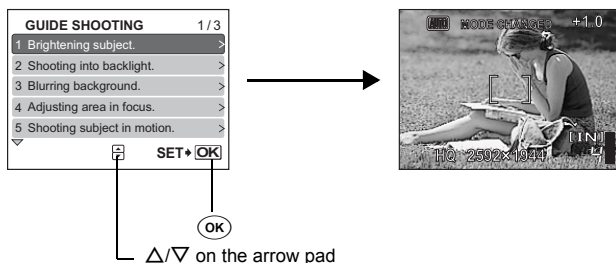

Δ/∇ on the arrow pad

Shooting mode: Zooming in on your subject

Wide-angle:
Push the zoom lever toward **W**.

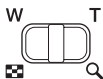

Telephoto:
Pull the zoom lever toward **T**.

Optical zoom magnification: 3X

Playback mode: Switching the picture display

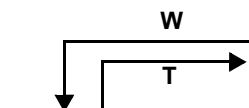

Single-frame playback

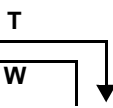

Close-up playback



Index display

- Use the arrow pad to select the picture to play back, and press **OK** to return to single-frame playback.



Returning to single-frame playback

Press **OK**.



Calendar display

- Use the arrow pad to select the date. Press **OK** to return to single-frame playback.

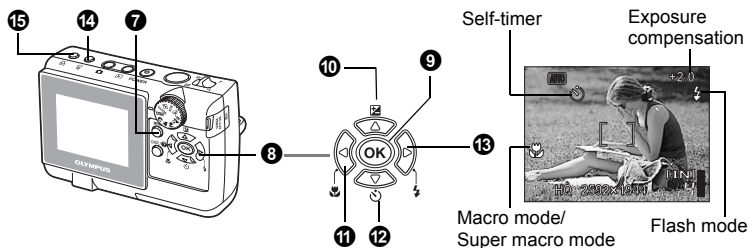

7 MENU button **Displaying the top menu**

Displays the top menu on the monitor.

8 Arrow pad ($\Delta/\nabla/\triangleleft/\triangleright$)

Use the arrow pad to select the playback picture and the items on the menus.

9 OK button

Press to set the settings.



10 Δ  button **Changing picture brightness**





Press the Δ  button in shooting mode.
Press $\triangleleft/\triangleright$ to adjust, and press OK.
 \triangleright : Adjusts toward [+].
 \triangleleft : Adjusts toward [-].



11 \triangleleft  button **Shooting pictures close to the subject**

Press the \triangleleft  button repeatedly in shooting mode. Press OK to set.

 Macro mode	This mode lets you shoot from 10 cm/3.9 in. (Most wide-angle side) to 60 cm/23.6 in. (Most telescopic side) for your subject.
 Super macro mode	This mode lets you shoot from as close as 5cm/2.0 in. to your subject.

12  **button****Self-timer shooting**

Press the  button repeatedly in shooting mode. Press  to set.



 ON	After setting this function, press the shutter button fully.
 OFF	Cancels self-timer function.

- The self-timer lamp lights for approximately 10 seconds, blinks for approximately 2 seconds, and then the picture is taken.
- Press the  button to cancel the self-timer.
- Self-timer shooting is automatically canceled after one shot.

13  **button****Flash shooting**

Press  button repeatedly in shooting mode to select the flash mode.

Press  to set.

AUTO (Auto-flash)	The flash fires automatically in low light or backlight conditions.
 Red-eye reduction flash	This emits pre-flashes for red-eye reduction.
 Fill-in flash	The flash fires regardless of the available light.
 Flash off	The flash does not fire even in low light conditions.

14  **button****Erasing pictures**

In playback mode, select the picture you want to erase, and press the  button.

- Once erased, pictures cannot be restored. Check each picture before erasing to avoid accidentally erasing pictures you want to keep.

 "Protecting pictures" (P.22)

15  **button****Printing**

In playback mode, select the picture you want to print, and press the  button.

 "Direct printing (PictBridge)" (P.33)

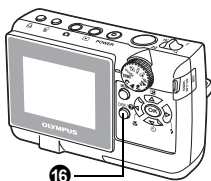

1

16 DISP./? button Changing the information display/Displaying the menu guide

Press the **DISP./?** button to change the display in the following order.

Shooting mode (Other than )

Playback mode

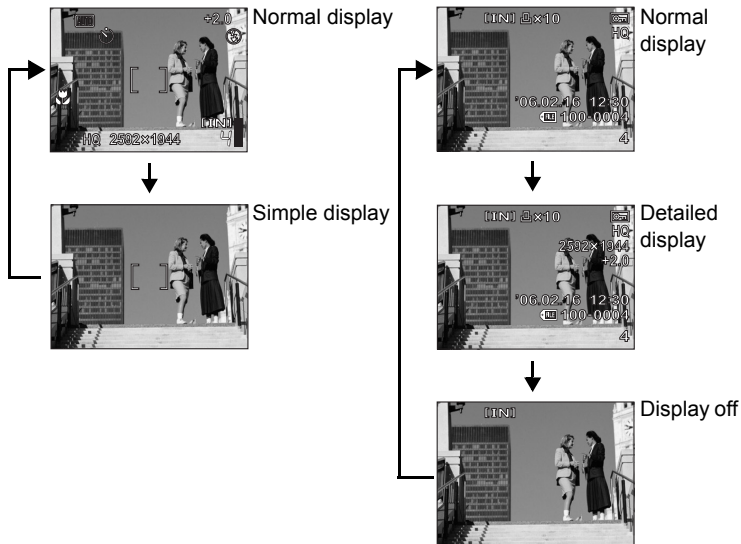

Displaying the menu guide

PIXEL MAPPING

Checks the CCD and image processing functions. This check should be conducted once a year at least one minute after shooting/playback.

With a menu item selected, hold down the **DISP./?** button. Release the **DISP./?** button to close the menu guide.

2 Menu operations

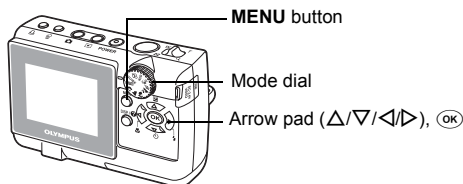

About the menu

Press the **MENU** button to display the top menu.

The menus on the top menu are changed by the modes.

- If you press the **MENU** button while the mode dial is set to **GUIDE**, the shooting guide screen is displayed.

Top menu

Shooting mode

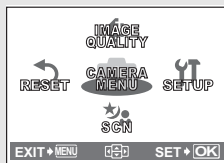

Playback mode

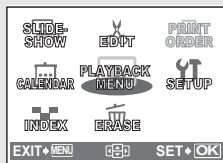

- When you select [CAMERA MENU], [PLAYBACK MENU], [EDIT], [ERASE] or [SETUP], the screen for the further settings will be displayed.

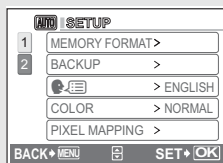

The screen when you select [SETUP]

Using the menus

Use the arrow pad and **OK** to set menu items.

This explains how to use the menu with the [VIDEO OUT] setting as an example.

Set the camera to the desired mode (Shooting mode or playback mode).

- In this section, press the **CAMERA** button to set to the shooting mode, and set the mode dial to the mode other than **GUIDE**.
- Common menus for each mode are retained even if the mode is changed.

1 Press the MENU button to display the top menu, and press **▷ and then press **OK**.**

- [VIDEO OUT] is on a menu in [SETUP]. Press **▷**.

2 Press **Δ/∇ to select a setting, and press **▷**.**

- Unavailable settings cannot be selected.

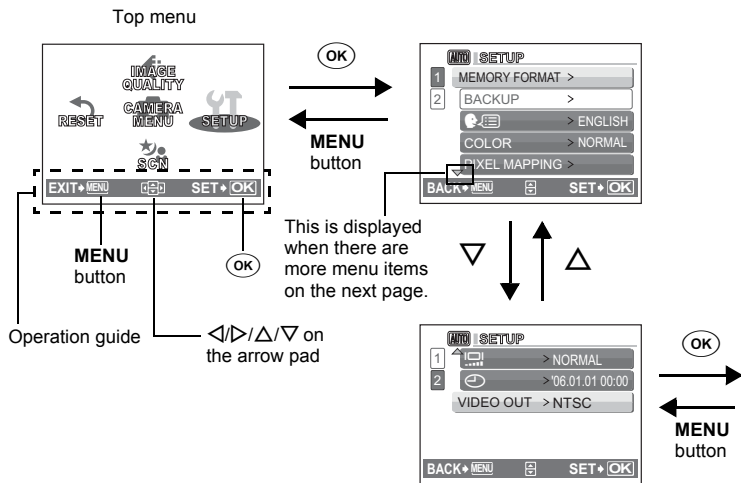

3 Press Δ/∇ to select a setting, and press OK .

- Select the video signal, [NTSC] or [PAL] from [VIDEO OUT] menu and then press OK .
- The menu item is set and the previous menu is displayed.
- Press the **MENU** button repeatedly, to close the menu.
- When the **MENU** button is pressed before pressing OK , a setting you set will not be changed.

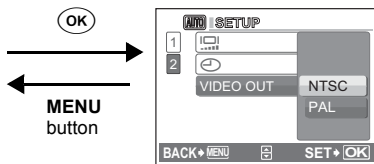

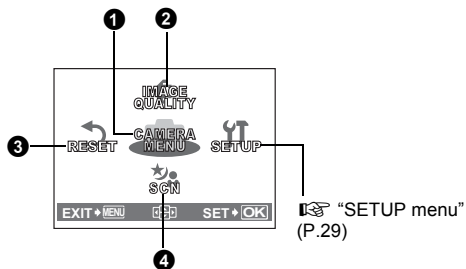

- 1 CAMERA MENU
DIGITAL ZOOM
PANORAMA^{*1}
- 2 IMAGE QUALITY
- 3 RESET
- 4 SCN (Scene)^{*2}

*1 xD-Picture Card (Optional) is required.

*2 Available when SCN is selected.

- The factory default settings are displayed in gray ().

1 CAMERA MENU

DIGITAL ZOOM..... Zooming in on your subject

OFF / ON

The digital zoom can be used to take close-up pictures with stronger magnification than the optical zoom.

(Optical zoom × Digital zoom Max. 12×)

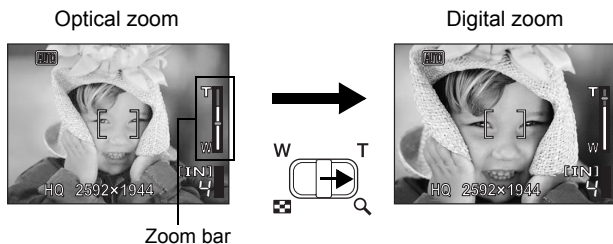

Zoom bar

White area: The optical zoom area

Red area: The digital zoom area

PANORAMA.....Creating a panoramic picture

Panorama shooting lets you create a panoramic picture, using the OLYMPUS Master software from the provided CD-ROM. An Olympus xD-Picture Card (referred to as "Card" in this manual) is required for panorama shooting.

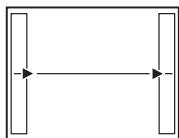

Connects pictures from left to right

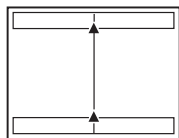

Connects pictures from bottom to top

- ▷: The next picture is connected at the right edge.
- ◁: The next picture is connected at the left edge.

- △: The next picture is connected at the top.
- ▽: The next picture is connected at the bottom.

Use the arrow pad to specify at which edge you want to connect the pictures, and then compose your shots so that the edges of the pictures overlap. The part of the previous picture where it will be joined to the next picture does not remain in the frame. You have to remember what the part in the frame looked like and take the next picture so it overlaps.

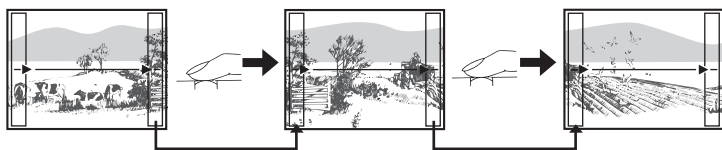

Panorama shooting is possible for up to 10 pictures. Press **OK** to exit panorama shooting.

Image quality for still picture shooting and their applications

Image quality/Image size	Compression	Application
SHQ FE-130/X-720/X-740 2592 × 1944 FE-140/X-725 2816 × 2112	Low compression	<ul style="list-style-type: none"> • This is useful for printing large images on A4-size (8 × 10 size) paper. • This is useful for performing computer image processing, such as contrast adjustment and red-eye reduction.
HQ FE-130/X-720/X-740 2592 × 1944 FE-140/X-725 2816 × 2112	Standard compression	
SQ1 2048 × 1536	Standard compression	<ul style="list-style-type: none"> • This is useful for postcard-sized (4 × 6 size) prints. • This is useful for computer editing such as rotating or adding text to a picture.
SQ2 640 × 480	Standard compression	<ul style="list-style-type: none"> • This is useful for sending as e-mail attachments.

Image quality for movie recording

Image quality/Image size
HQ 320 × 240
SQ 160 × 120



3 RESET

Resetting the settings to the default

NO / YES

To reset the shooting mode settings to the factory default, use the reset function.

Functions that RESET affects and their factory default settings

Function	Factory default setting	Ref. Page
FLASH MODE	AUTO	P.13
	OFF	P.12
	0.0	P.12
IMAGE QUALITY	HQ	P.20
DIGITAL ZOOM	OFF	P.18

4 SCN (Scene) Shooting pictures by selecting a scene according to the situation

NIGHT + PORTRAIT	INDOOR	CANDLE
SELF PORTRAIT	AVAILIABLE LIGHT	SUNSET
FIREWORKS	MUSEUM	BEHIND GLASS
CUISINE	DOCUMENTS	AUCTION
BEACH	SNOW	

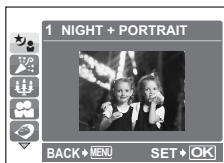

- The scene selection screen displays sample images and the shooting mode to best suit the situation.
- If switching to the other scene, the settings of each scene will return to default except a few settings.

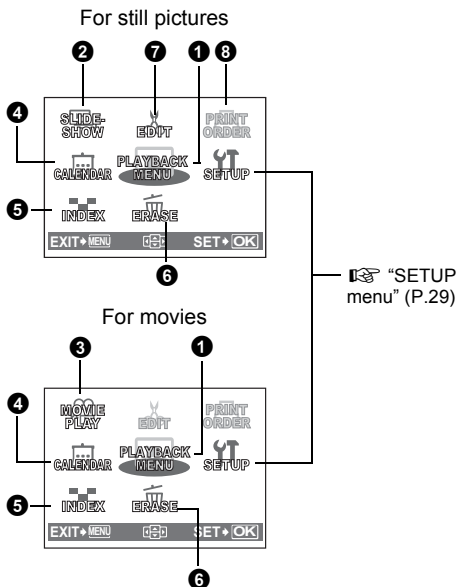

1 PLAYBACK MENU

- 1
- 2 SLIDESHOW
- 3 MOVIE PLAY
- 4 CALENDAR
- 5 INDEX
- 6 ERASE
SEL. IMAGE
ALL ERASE
- 7 EDIT*1
 REEYE FIX
 BLACK & WHITE
 SEPIA
 FRAME
 TITLE
 CALENDAR
 LAYOUT
 BRIGHTNESS
 SATURATION
- 8 PRINT ORDER*1*2

*1 This setting is not available for a movie data.

*2 xD-Picture Card (Optional) is required.

- The factory default settings are displayed in gray ().

1 PLAYBACK MENU

.....Protecting pictures

OFF / ON



Protected pictures cannot be erased by the single-frame/all-frame erase function, but they are all erased by formatting.

- Press / to select a picture, and press / to set the protector [ON]. You can continue to protect other pictures.

+90° / 0° / -90°

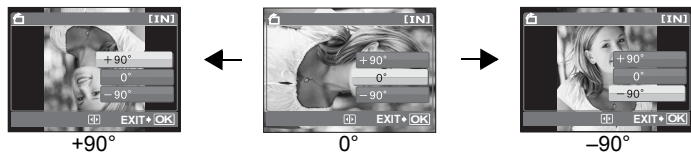

Pictures taken with the camera held vertically are displayed horizontally. This function lets you turn such pictures so that they are displayed vertically. New picture orientations are saved even when the power is turned off.

- You can select the picture to rotate by pressing $\triangleleft/\triangleright$.

2 SLIDESHOW

Playing back pictures automatically

NORMAL /FADER /SLIDE /ZOOM

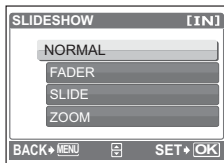

- Select the transition effect between pictures.
- Press OK to start the slideshow.
- Only the first frame of each movie is displayed.
- Press OK again to cancel the slideshow.



Select the data with and press to playback a movie. Selecting [MOVIE PLAY] from the top menu and pressing will also playback a movie.

Operations during movie playback

Press to pause playback. Press again to replay the movie.



Playing time/Total recording time

- : Each time you press the button, the playback speed changes in the following order: 2x; 20x; and back to 1x.
- : Plays the movie in reverse. Each time you press the button, the playback speed changes in the following order: 2x; 20x; and back to 1x.

Operations during pause



- : Displays the first frame.
- : Displays the last frame.

- : Displays the next frame.
- : Displays the previous frame.

- Press the **MENU** button to cancel movie playback.

4 CALENDAR

Playing back pictures in a calendar

When a still picture or movie is recorded, it is automatically registered to the calendar by the date of recording.

“Zoom lever Zooming while shooting/close-up playback” (P.11)

5 INDEX

Viewing the pictures as an index

Pictures are shown on the index display.

“Zoom lever Zooming while shooting/close-up playback” (P.11)

6 ERASE

Erasing pictures

Protected pictures cannot be erased. Cancel the protection before erasing such pictures. Once erased, pictures cannot be restored. Check each picture before erasing to avoid accidentally erasing pictures you want to keep.

SEL. IMAGEErasing selected picture



- Press $\Delta/\nabla/\leftarrow/\rightarrow$ to select a picture, and press OK to add \checkmark .
- Press OK again to cancel the selection.
- Press HOME after selecting pictures to erase.

ALL ERASEErasing all pictures in the internal memory or on the card

- Select [YES], and press OK .
- To erase pictures stored in the internal memory, remove the card from the camera.
- To erase pictures stored on the card, insert the card to a camera.

You can edit a picture recorded on the internal memory or on the card and save it as a new picture.

.....Reducing the size of picture

640 × 480 /320 × 240

This changes the image size of a picture and saves it as a new file.

.....Zooming in the part of pictures

Crops part of a picture and saves it as a new file.



- $\Delta/\nabla/\leftarrow/\rightarrow$: Adjusts the position of the picture.
- Zoom lever: Adjusts the size of the picture.

REDEYE FIX.....Fixing the red-eye in pictures

This function corrects the red-eye look that often occurs when taking pictures with a flash.

BLACK & WHITE.....Changing pictures to black and white

This changes the picture to black and white and saves it as a new file.

SEPIAChanging pictures to a sepia tone

This changes the picture to sepia and saves it as a new file.

FRAME.....Adding frames to the pictures

Adds a selected frame to a picture and saves it as a new picture.

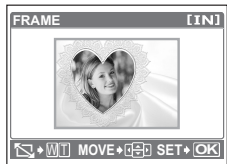

- Press \leftarrow/\rightarrow to select a frame, and press OK .
- Press \leftarrow/\rightarrow to select the picture to which you want to add the frame, and press OK .
Press Δ/∇ to rotate the picture 90° clockwise or counterclockwise.
- Adjust the position and size of the picture, and press OK .

TITLE **Adding titles to the pictures**

Adds a selected title to a picture and saves it as a new picture.



- Press \leftarrow/\rightarrow to select a picture, and press OK .
- Press \leftarrow/\rightarrow to select a title, and press OK .
Press Δ/∇ to rotate the picture 90° clockwise or counterclockwise.
- Adjust the position and size of the title, and press OK .
- Press $\Delta/\nabla/\leftarrow/\rightarrow$ to select the color of the title, and press OK .

CALENDAR **Adding calendars to the pictures**

Adds a calendar to a picture and saves it as a new picture.

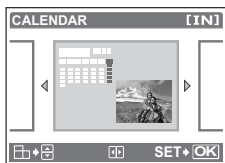

- Press \leftarrow/\rightarrow to select a picture, and press OK .
- Press \leftarrow/\rightarrow to select a calendar, and press OK .
Press Δ/∇ to rotate the picture 90° clockwise or counterclockwise.
- Set the date of the calendar, and press OK .

LAYOUT **Arranging and combining multiple pictures**

ALL IMAGES	All pictures in the internal memory or the card are added to the layout.
CALENDAR	Select the pictures you want to add to the layout by day from the monthly display.
SEL. IMAGE	Select the pictures to be added to the layout individually.

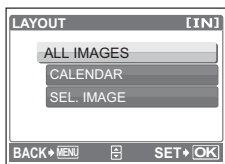

- Press \leftarrow/\rightarrow to select a layout, and press OK .
- Select the type of layout picture, and press OK .
- Select the pictures, and press OK .

BRIGHTNESS Changing brightness of the pictures

Adjusting the brightness of a picture and saves the picture as a new file.

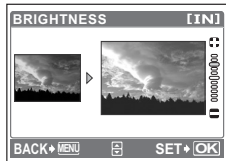

- Adjust the brightness by pressing Δ/∇ .

SATURATION Changing color strength of the pictures

Adjusting the color strength of a picture and saves the picture as a new file.

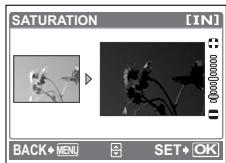

- Adjust the color strength by pressing Δ/∇ .

8 PRINT ORDER**Making print reservations (DPOF)**

This function allows you to save printing data (the number of prints and the date and time information) with the pictures stored on the card.

"Print settings (DPOF)" (P.39)

SETUP menu

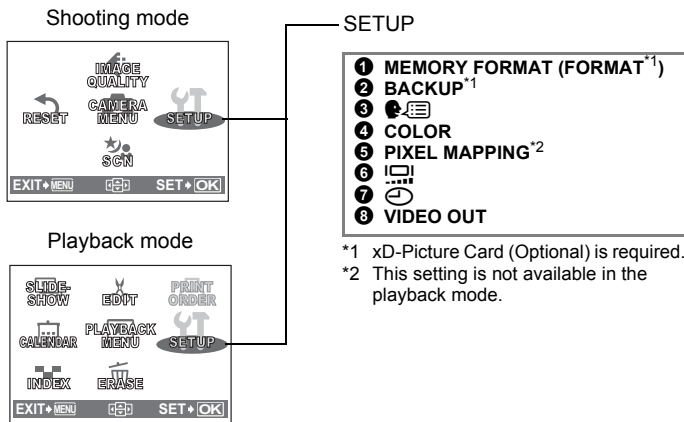

1 MEMORY FORMAT (FORMAT) Formatting the internal memory or card

All existing data, including protected pictures, are erased when the internal memory or the card is formatted. Make sure that you save or transfer important data to a computer before formatting the card.

- Make sure there is no card inserted in the camera when formatting the internal memory.
- Be sure that the card is inserted in the camera when formatting the card.
- Before using non-Olympus cards or cards which have been formatted on a computer, you must format them with this camera.

2 BACKUP Copying pictures in the internal memory to the card

Insert the optional card into the camera. A backup does not erase the picture in the internal memory.

- It takes time copying pictures. Confirm that there is enough battery power remaining. Or use an AC adapter.

3 Selecting a display language

You can select a language for on-screen display. Available languages vary depending on the area where you purchased this camera.

You can add other languages to your camera with the provided OLYMPUS Master software.

4 COLOR**Setting the color of the menu screens**

NORMAL / GREEN / PINK

5 PIXEL MAPPING**Adjusting the image processing function**

The pixel mapping function allows the camera to check and adjust the CCD and image processing functions. It is not necessary to operate this function frequently. Approximately once a year is recommended. Wait at least one minute after taking or viewing pictures to allow the pixel mapping function to perform properly. If you turn the camera off during pixel mapping, start again.

Select [PIXEL MAPPING]. When [START] is displayed, press **OK**.

6 **Adjusting the monitor brightness**

BRIGHT / NORMAL

7 **Setting the date and time**

The date and time is saved with each image, and is used in the file name.

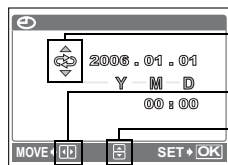

Δ/∇ : Selects the date format (Y-M-D, M-D-Y, D-M-Y).

$\triangleleft/\triangleright$: Moves to the previous or next setting.

Δ/∇ : Sets the date and time.

- The first two digits of the year are fixed.
- The time is displayed in the 24-hour format.
- For more accurate setting, press **OK** when the time signal hits 00 seconds.

NTSC / PAL

The factory default settings differ according to the region where the camera is sold.

To play back camera images on a TV, set the video output according to your TV's video signal type.

- The video signal types for different countries and districts are written below.

Check the video signal type before connecting the camera to the TV.

NTSC: North America, Taiwan, Korea, Japan

PAL: European countries, China

Playing back pictures on a TV

Turn off the camera and the TV before connecting.

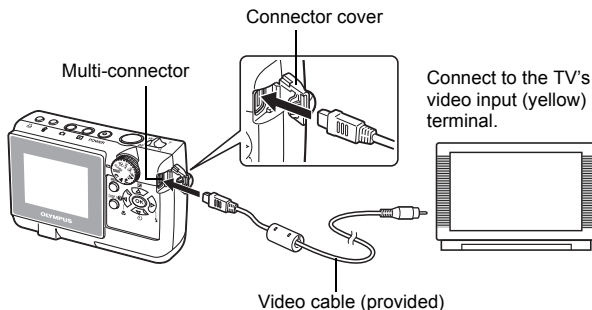

Settings on the camera

Press the  button to turn the camera on.

- The last picture taken is displayed on the TV. Use the arrow pad to select the picture you want to display.

Settings on the TV

Turn the TV on, and set TV's setting to video input mode.

- For details of switching to video input, refer to your TV's instruction manual.

3 Printing pictures

You can print out the pictures you have taken.

If you print the pictures at home, you can either connect the camera directly to the printer or you can connect the camera to a computer and download the pictures to the computer first.

If you go to a photo store, it is a good idea to store the print reservation data on the card first. With print reservation, you can print out pictures easily either at home using a personal DPOF-compatible printer or at a photo store that supports DPOF. DPOF is a standard format used to record automatic print information from digital cameras. It allows you to store data such as which pictures you want to print and the number of prints so that you can print pictures automatically at home or at a photo store.

This chapter explains direct printing and print reservations.

3

Printing pictures

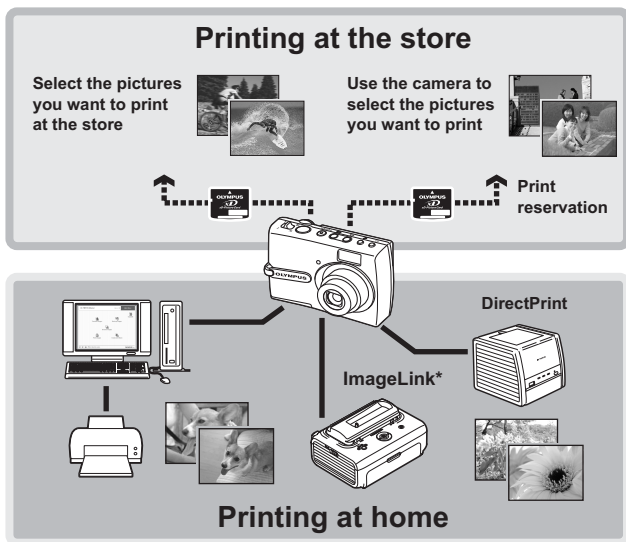

* For more details on printers which are compatible to the ImageLink print system, refer to the printer's instruction manual.

Direct printing (PictBridge)

Using the direct printing function

By connecting the camera to a PictBridge-compatible printer, you can print out pictures directly. Select the pictures you want to print and the number of prints on the camera's monitor.

To find out if your printer is compatible with PictBridge, refer to the printer's instruction manual.

What is PictBridge?

A standard for connecting digital cameras and printers of different makers and printing out pictures directly.

- Available printing modes, paper sizes etc., vary depending on the printer you use. Refer to the instruction manual for your printer.
- For details of printing paper types, ink cassettes, etc., refer to the printer's instruction manual.

Printing pictures

Select [EASY PRINT] to print out the picture displayed on the monitor using the standard setting of your printer. The date and file name are not printed.

Standard settings

All printers that support PictBridge have standard print settings. If [STANDARD] is selected on the settings screens (P.36 and 37), pictures are printed according to these settings. For its standard settings refer to the printer's instruction manual or contact the printer manufacturer.

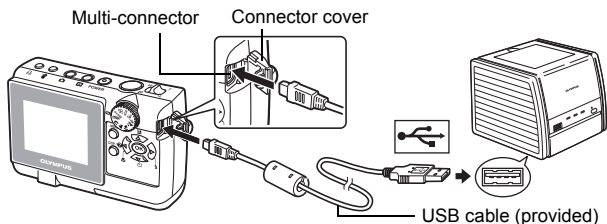

- 1 In the playback mode, display the picture you want to print out on the monitor.**
- 2 Connect one end of the provided USB cable into the camera's multi-connector and the other end into the printer's USB connector.**



- The [EASY PRINT START] screen is displayed.
- For details of how to turn the printer on and the position of the USB port, refer to the printer's instruction manual.

3 Press the button.

- Printing starts.

- When printing is finished, the picture selection screen is displayed. To print another picture, press /  to select a picture, and press the  button.
- When you have finished, disconnect the USB cable from the camera with the picture selection screen displayed.

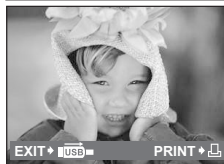

4 Disconnect the USB cable from the camera.

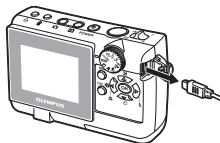

5 Disconnect the USB cable from the printer.

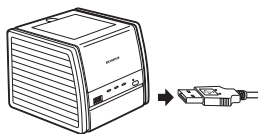

Other print modes and print settings (CUSTOM PRINT)

- 1 Follow the step 1 and 2 on page 33 to display a scene shown right, and press **OK**.

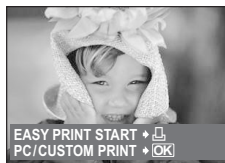

[USB] screen

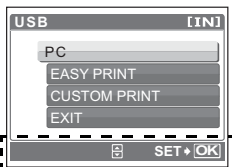

Operation guide

- 2 Select **[CUSTOM PRINT]**, and press **OK**.

- When the camera turned off is connected to a PC with the attached USB cable, the [USB] screen appears on the monitor of the camera.

- 3 Follow the operation guide to set each setting.

Selecting a print mode

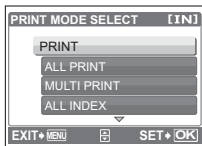

PRINT	Prints the selected picture.
ALL PRINT	Prints all the pictures stored in the internal memory or on the card.
MULTI PRINT	Prints one picture in multiple layout format.
ALL INDEX	Prints an index of all the pictures stored in the internal memory or on the card.
PRINT ORDER	Prints the pictures according to the print reservation data on the card. If no print reservations have been made, this option is not available. ☞ "Print settings (DPOF)" (P.39)

Setting the printing paper

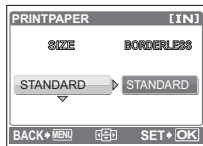



SIZE	Choose from the available paper sizes on your printer.
BORDERLESS	Select framed or unframed. In [MULTI PRINT] mode, this function is not available.
OFF (<input type="checkbox"/>)	The picture is printed inside a blank frame.
ON (<input type="checkbox"/>)	The picture is printed filling the entire page.
PICS/SHEET	Available in [MULTI PRINT] mode only. The number of prints that can be printed vary depending on the printer.

If the [PRINTPAPER] screen is not displayed, [SIZE], [BORDERLESS] and [PICS/SHEET] are set to [STANDARD].

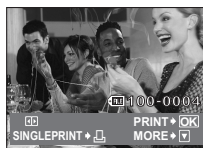
Selecting the picture to print



PRINT	Prints one copy of the selected picture. When [SINGLE PRINT] or [MORE] is set to a picture, the picture will be printed with the setting.  Go to Step 4.
SINGLE PRINT	Makes a print reservation for the displayed picture.
MORE	Sets the number of prints and data to be printed for the displayed picture.

Press  to select the picture you want to print. You can also use the zoom lever and select a picture from the index display.

Setting the number of prints and data to be printed

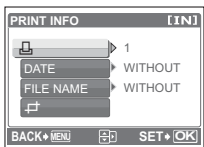

	Sets the number of prints. You can select up to 10 prints.
DATE (🕒)	If you select [WITH], pictures are printed with the date.
FILE NAME (📄)	If you select [WITH], pictures are printed with the file name.
	Crops part of a picture and prints it. <ul style="list-style-type: none"> Use the zoom lever to adjust the trimming size and the arrow pad to adjust the trimming position, and press OK.

4 Select [PRINT], and press **OK**.

- Printing starts.
- When printing is finished, the [PRINT MODE SELECT] screen is displayed.

To cancel printing

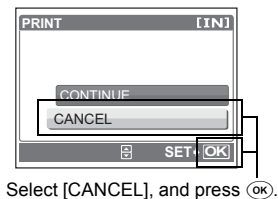
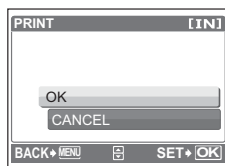
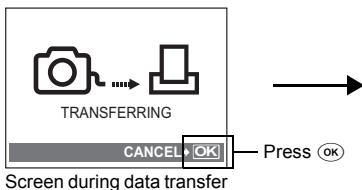

5 In the [PRINT MODE SELECT] screen, press the **MENU** button.

- A message is displayed.

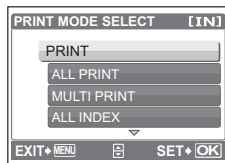

6 Disconnect the USB cable from the camera.

- The camera turns off.

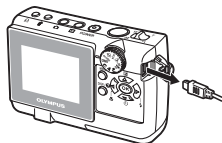
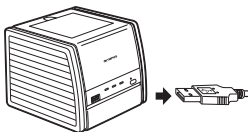
**7 Disconnect the USB cable from the printer.**

Print settings (DPOF)

How to make print reservations

Print reservation allows you to save printing data (the number of prints and the date and time information) with the pictures stored on the card.

Only the images stored on the card can be reserved to print. Insert a card with recorded pictures into the camera before making print reservations.

Pictures with print reservations can be printed using the following procedures.

Printing using a DPOF-compatible photo store:

You can print the pictures using the print reservation data.

Printing using a DPOF-compatible printer:

Printing is possible directly from a card containing print reservation data, without using a computer. For more details, refer to the printer's instruction manual. A PC card adapter may also be necessary.

Note

- This camera cannot change DPOF reservations set by another device. Make changes using the original device. If a card contains DPOF reservations set by another device, entering reservations using this camera may overwrite the previous reservations.
- Not all functions may be available on all printers, or at all photo stores.

Using print services without using DPOF

- Pictures stored in the internal memory cannot be printed at a photo store. The pictures need to be copied to a card before taking them.

 "BACKUP Copying pictures in the internal memory to the card" (P.29)

Single-frame reservation

Follow the operation guide to make a print reservation for a selected picture.

1 In the playback mode, press the **MENU** button to display the top menu.

2 Select [PRINT ORDER] ▶ [⏏], and press **OK**.

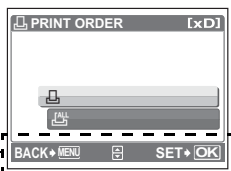

Operation guide

3 Press **</>** to select the frames for print reservations, and then press **Δ/∇** to set the number of prints.

- You cannot make print reservations for pictures with .
- Repeat this step to make print reservations for other pictures.



Trimming the picture

- Push the zoom lever to **W**, or pull the zoom lever to **T**.
- Use the zoom lever to adjust the trimming size and the arrow pad to adjust the trimming position, and press **OK**.



4 When you finish making print reservations, press **OK**.

5 Select the date and time print setting, and press OK .

- NO** The pictures are printed without the date and time.
DATE The selected pictures are printed with the shooting date.
TIME The selected pictures are printed with the shooting time.

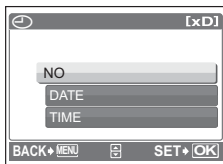

6 Select [SET], and press OK .

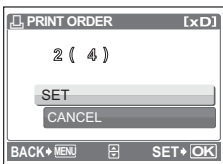

All-frame reservation

Reserves all the pictures stored on the card. The number of prints is set at one print per picture.

1 In the playback mode, press the MENU button to display the top menu.

2 Select [PRINT ORDER] \blacktriangleright [ALL], and press OK .

3 Select the date and time print setting, and press OK .

- NO** The pictures are printed without the date and time.
DATE All pictures are printed with the shooting date.
TIME All pictures are printed with the shooting time.

4 Select [SET], and press OK .

Resetting print reservation data

You can reset all the print reservation data or just for selected pictures.

- 1 Select the top menu ▶ [PRINT ORDER], and press (OK).

To reset the print reservation data for all the pictures

- 2 Select [] or [ALL], and press (OK).
- 3 Select [RESET], and press (OK).

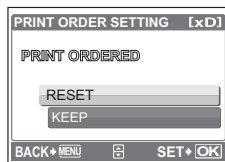

To reset the print reservation data for a selected picture

- 2 Select [], and press (OK).
- 3 Select [KEEP], and press (OK).
- 4 Press </> to select the picture with the print reservations you want to cancel, and press ∇ to decrease the number of prints to 0.
 - Repeat this step to cancel print reservations for other pictures.
- 5 When you have finished canceling print reservations, press (OK).
- 6 Select the date and time print setting, and press (OK).
 - The setting is applied to the remaining pictures with print reservations.
- 7 Select [SET], and press (OK).

4 Connecting the camera to a computer

Flow

Using the USB cable provided with your camera, you can connect the camera to a computer and download (transfer) the images to your computer using the OLYMPUS Master software, also provided with the camera.

Prepare the following items before starting.



OLYMPUS Master CD-ROM



USB cable



Computer equipped with a USB port

Install the OLYMPUS Master software P.44

Connect the camera to the computer using the USB cable P.48

Start up the OLYMPUS Master software P.49

Download image files to the computer P.50

Disconnect the camera from the computer P.50

Using OLYMPUS Master

What is OLYMPUS Master?

OLYMPUS Master is an application software for editing images taken with a digital camera on a computer. Installing it on your computer lets you do the following:

- **Download images from the camera or other media**
- **View images and movies**
You can run a slideshow and playback movies.
- **Manage images**
You can organize your images using the calendar display. Search the image you want by date or keyword.
- **Edit images**
You can rotate images, trim them and change the size.
- **Edit images with the filter and correction functions**



- **Print images**
You can print images and make indexes, calendars and postcards.
- **Make panoramic images**
You can make panoramic images using pictures taken in panorama mode.

For details of other functions and operations, refer to the "Help" guide and OLYMPUS Master reference manual.

Install the OLYMPUS Master software

Before installing the OLYMPUS Master software, please confirm that your computer is compatible with the following system requirements.

For newer operating systems, please refer to the Olympus web site as shown on the back cover of this manual.

Operating environment

Windows

OS	Windows 98SE/Me/2000 Professional/XP
CPU	Pentium III 500 MHz or later
RAM	128 MB or more (at least 256 MB is recommended)
Hard disk capacity	300 MB or more
Connector	USB port
Monitor	1,024 × 768 pixels, 65,536 colors or more

Note

- Data transfer is only guaranteed on computers with a factory installed OS.
- To install the software in Windows 2000 Professional/XP, you must log on as a user with administrators' privileges.
- Internet Explorer and QuickTime 6 or later should be installed on your computer.
- Windows XP corresponds to Windows XP Professional/Home Edition.
- Windows 2000 corresponds to Windows 2000 Professional.
- If you are using Windows 98SE, the USB driver is installed automatically.

Macintosh

OS	Mac OS X 10.2 or later
CPU	Power PC G3 500 MHz or later
RAM	128 MB or more (at least 256 MB is recommended)
Hard disk capacity	300 MB or more
Connector	USB port
Monitor	1,024 × 768 pixels, 32,000 colors or more

Note

- Operation is only guaranteed on a Macintosh equipped with a built-in USB port.
- QuickTime 6 or later and Safari 1.0 or later should be installed on your computer.
- Be sure to remove the media (drag & drop onto the trash icon) before performing the following operations. Failure to do so could result in unstable computer operation and the need to reboot.
 - Disconnect the cable connecting the camera to the computer.
 - Turn off the camera.
- Open the camera's battery compartment/card cover.

Windows

1 Insert the CD-ROM into the CD-ROM drive.

- The OLYMPUS Master setup screen is displayed.
- If the screen is not displayed, double-click the "My Computer" icon and click the CD-ROM icon.



2 Click "OLYMPUS Master".

- The QuickTime installation screen is displayed.
- QuickTime is required to use OLYMPUS Master. If the QuickTime screen is not displayed, QuickTime 6 or later is already installed on the computer. In this case, go to step 4.

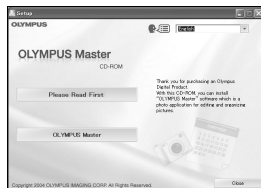

3 Click "Next" and follow the on-screen instructions.

- When the QuickTime licensing agreement is displayed, read the agreement and click "Agree" to proceed with the installation.
- The OLYMPUS Master installation screen is displayed.

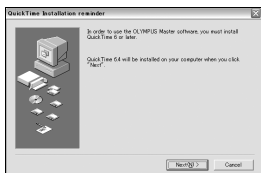

4 Follow the on-screen instructions.

- When the OLYMPUS Master licensing agreement is displayed, read the agreement and click “Yes” to proceed with the installation.

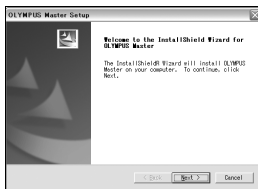

- When the “User Information” dialog box is displayed, enter your “Name” and “OLYMPUS Master Serial Number”; select your region and click “Next”. For the serial number, refer to the sticker on the CD-ROM package.

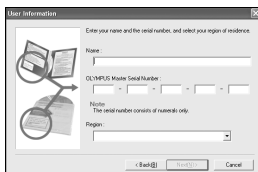

- When the DirectX licensing agreement is displayed, read the agreement and click “Yes”.
- A screen asking whether or not you want to install Adobe Reader is displayed. Adobe Reader is required to read the OLYMPUS Master instruction manual. To install Adobe Reader, click “OK”. If this screen is not displayed, Adobe Reader is already installed on your computer.

5 Follow the on-screen instructions.

- The screen confirming that installation is completed is displayed. Click “Finish”.

6 Select the option to restart immediately when the screen asking you if you wish to restart the computer is displayed and click “OK”.

- The computer restarts.
- Remove the CD-ROM from the CD-ROM drive and store it.

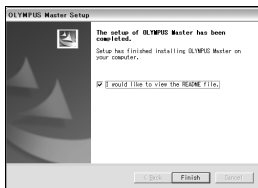

Macintosh

1 Insert the CD-ROM into the CD-ROM drive.

- The CD-ROM window is displayed.
- If the CD-ROM window is not displayed, double-click the CD-ROM icon on the desktop.



2 Double-click on the desired language folder.

3 Double-click the “Installer” icon.

- The OLYMPUS Master installer starts up.
- Follow the on-screen instructions.
- When the OLYMPUS Master licensing agreement is displayed, read the agreement and click “Continue” and then “Agree” to proceed with the installation.
- The screen confirming that installation is completed is displayed.



4 Click “Finish”.

- The first screen is displayed.

5 Click “Restart”.

- The computer restarts.
- Remove the CD-ROM from the CD-ROM drive and store it.

Connecting the camera to a computer

1 Make sure the camera is turned off.

- The monitor is off.
- The lens is retracted.

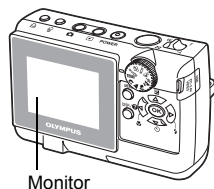

2 Connect the multi-connector on the camera to the USB port on the computer using the provided USB cable.

- Refer to your computer's instruction manual to locate the position of the USB port.
- The camera turns on automatically.
- The monitor turns on and the selection screen for the USB connection is displayed.

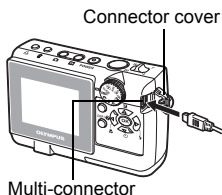

3 Select [PC], and press **OK**.

4 The camera is recognized by the computer.

• Windows

When you connect the camera to the computer for the first time, the computer attempts to recognize the camera. Click "OK" to exit the message that is displayed. The camera is recognized as a "Removable Disk".

• Macintosh

The iPhoto program is the default application for managing digital images. When you connect the camera for the first time, the iPhoto application starts automatically, so close this application and start OLYMPUS Master.

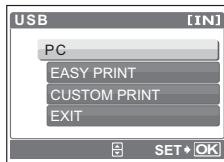

Note

- The camera functions are disabled while the camera is connected to a computer.

Start up the OLYMPUS Master software

Windows

1 Double-click the “OLYMPUS Master” icon on the desktop.

- The main menu is displayed.
- When OLYMPUS Master is started up for the first time after installation, the “Registration” dialog box is displayed before the main menu. Follow the prompts and fill in the registration form.

Macintosh

1 Double-click the “OLYMPUS Master” icon in the “OLYMPUS Master” folder.

- The main menu is displayed.
- When OLYMPUS Master is started up for the first time, the “User Information” dialog box is displayed before the main menu. Enter your “Name” and “OLYMPUS Master Serial Number”, and select your region.
- After the “User Information” dialog box, the “Registration” dialog box is displayed. Follow the prompts and fill in the registration form.

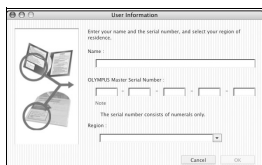

OLYMPUS Master main menu

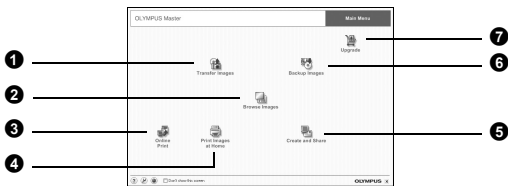

- 1 “Transfer Images” button**
Downloads images from the camera or other media.
- 2 “Browse Images” button**
The “Browse” window is displayed.
- 3 “Online Print” button**
The online print window is displayed.
- 4 “Print Images at Home” button**
The print menu is displayed.
- 5 “Create and Share” button**
The editing menu is displayed.
- 6 “Backup Images” button**
Creates backup images.
- 7 “Upgrade” button**
Displays window for optional upgrade to OLYMPUS Master Plus.

To exit OLYMPUS Master

1 Click “Exit” on the main menu.

- OLYMPUS Master is exited.

Displaying camera images on a computer

Downloading and saving images

1 Click “Transfer Images” on the OLYMPUS Master main menu.

- The menu for selecting the source is displayed.

2 Click “From Camera” .

- The window for selecting images is displayed. All the images in the camera are displayed.

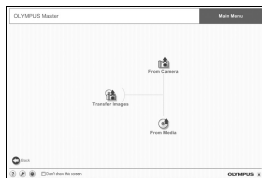

3 Select the image files and click “Transfer Images”.

- A window indicating that the download is complete is displayed.

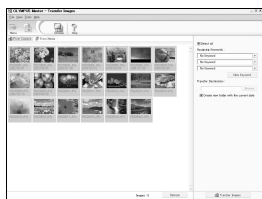

4 Click “Browse images now”.

- The downloaded images are displayed in the browse window.
- Click “Menu” in the “Browse” window, to return to the main menu.

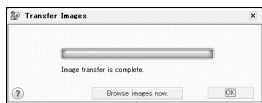

To disconnect the camera

1 Make sure that the card access lamp is not blinking.

Card access lamp

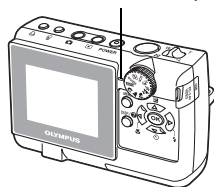

2 Make the following preparations for disconnecting the USB cable.

Windows 98SE

- ① Double-click the “My Computer” icon and right-click the “Removable Disk” icon to display the menu.
- ② Click “Eject” on the menu.



Windows Me/2000/XP

- ① Click the “Unplug or Eject Hardware” icon  in the system tray.
- ② Click the message that is displayed.
- ③ When a message is displayed saying that the hardware can be ejected safely, click “OK”.

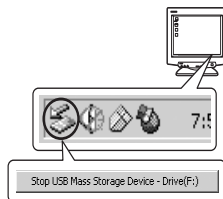

Macintosh

- ① The trash icon changes to the eject icon when the “Untitled” or “NO_NAME” icon on the desktop is dragged. Drag and drop it on the eject icon.



3 Disconnect the USB cable from the camera.

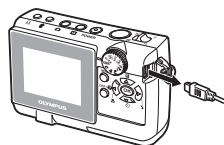

Note

- Windows Me/2000/XP: When you click “Unplug or Eject Hardware”, a warning message may be displayed. Make sure that image data is not being downloaded from the camera and that all applications are closed. Click the “Unplug or Eject Hardware” icon again and disconnect the cable.

Viewing still pictures and movies

1 Click “Browse Images” on the OLYMPUS Master main menu.

- The “Browse” window is displayed.

2 Double-click the still picture thumbnail that you want to view.

Thumbnail

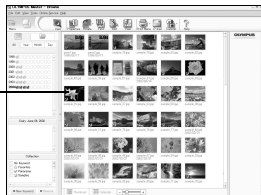

- The camera switches to view mode and the picture is enlarged.
- To return to the main menu, click “Menu” in the “Browse” window.

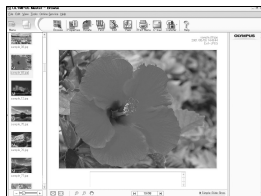

To view a movie

1 Double-click the movie thumbnail that you want to see in the “Browse” window.

- The camera switches to view mode and the first frame of the movie is displayed.

2 Click the playback button at the bottom of the screen, to play back the movie.

The names and functions of the controller parts are shown below.



Item	Description
1 Playback slider	Move the slider to select a frame.
2 Time display	Displays the time that has elapsed during playback.
3 Playback (pause) button	Plays back the movie. Functions as the pause button during playback.
4 Back button	Displays the previous frame.
5 Forward button	Displays the next frame.
6 Stop button	Stops playback and returns to the first frame.
7 Repeat button	Plays back the movie repeatedly.
8 Volume button	Displays the volume adjustment slider.

Printing pictures

Pictures can be printed from the photo, index, postcard and calendar menus. The explanation below uses the photo menu.

1 Click “Print Images at Home”  on the OLYMPUS Master main menu.

- The print menu is displayed.

2 Click “Photo” .

- The “Photo Print” window is displayed.

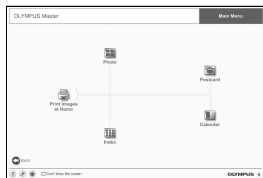

3 Click “Settings” in the “Photo Print” window.

- The printer settings screen is displayed. Make the necessary printer settings.

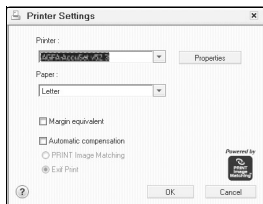

4 Select a layout and size.

- To print the date and time with your image, check the box next to “Print Date”, and select between “Date” and “Date & Time”.

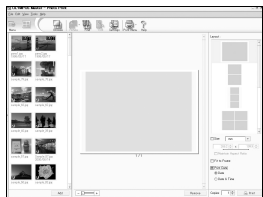

5 Select the thumbnail image that you want to print and click “Add”.

- A preview of the selected image is displayed on the layout.

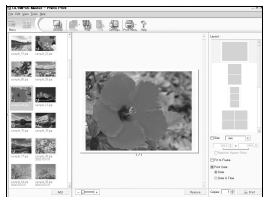

6 Select the number of copies.

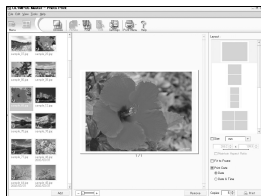

7 Click "Print".

- Printing starts.
- Click "Menu" in the "Photo Print" window, to return to the main menu.

To download and save images to a computer without using OLYMPUS Master

This camera is compatible with USB mass storage. You can connect the camera to the computer using the USB cable provided with the camera to download and save images without using OLYMPUS Master. The following environment is required to use the USB cable to connect the camera to the computer.

Windows: Windows 98SE/Me/2000 Professional/XP

Macintosh: Mac OS 9.0 to 9.2/X

Note

- If the computer is running Windows 98SE, you will need to install the USB driver. Before connecting the camera to the computer with the USB cable, double-click the files from the following folders on the provided OLYMPUS Master CD-ROM.
(Drive name): \USB\INSTALL.EXE
- Data transfer is not guaranteed in the following environments, even if the computer is equipped with a USB port.
 - Windows 95/98/NT 4.0
 - Windows 98SE upgrades from Windows 95/98
 - Mac OS 8.6 or earlier
 - Computers with a USB port added by means of an extension card, etc.
 - Computers without a factory-installed OS and home-built computers

5 Getting to know your camera better

Shooting tips and information

Tips before you start taking pictures

The camera does not turn on even when a battery is loaded

The batteries are loaded incorrectly

- Reload the batteries correctly.

The batteries are exhausted

- Replace the batteries with new ones, or charge the batteries.

The battery is temporarily unable to function because of the cold

- Battery performance declines in low temperatures, and the charge may not be sufficient to turn on the camera. Remove the battery and warm it by putting it in your pocket for a while.

No picture is taken when the shutter button is pressed

The camera is in sleep mode

- To save battery power, the camera automatically switches to sleep mode and the monitor turns off if there is no operation when the camera is turned on (when the lens is extended and the monitor is on). No picture is taken even if the shutter button is fully pressed in this mode. Operate the zoom lever or other buttons to restore the camera from sleep mode before taking a picture. If the camera is left for several hours, it automatically turns off (the lens retracts and the monitor turns off). And when the camera is turned on with playback mode, the camera does not switch to sleep mode and the camera will turn off automatically when it left for about 3 minutes. Press the **POWER** button to turn the camera on.

The mode dial is set to **GUIDE**

- You cannot take pictures while the guide is displayed. To take a picture, complete the desired setting by following the guide, or set the mode dial to other than **GUIDE** for the shooting mode.

The flash is charging

- Wait until the  (flash charge) mark stops blinking then press the shutter button again.

The memory gauge is full

- No pictures can be taken when the memory gauge is full. Wait until there is space in the memory gauge.

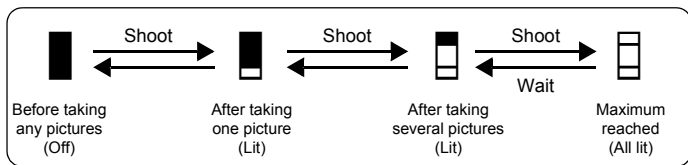

The time and date have not been set

Using the camera with the default setting

- The default setting of the date and time is not correct. Set the correct time and date.

“Setting the date and time” (P.30)

The battery has been removed

- When the camera is left for about three days without the battery, the time and date will be returned to the factory default. Confirm the time and date before taking any pictures.

Shooting tips

Focusing on the subject

There are several ways to focus, depending on the subject.

When the subject is not in the center of the frame

- Place the subject in the center of the frame, lock the focus on the subject, and then recompose your picture.

“Shutter button Shooting picture” (P.8)

The subject is moving quickly

- Focus the camera on a point roughly the same distance away as the subject you want to shoot (by pressing the shutter button halfway), and then recompose your picture and wait for the subject to enter the frame.
- Set the mode dial to to shoot.

Subjects that are difficult to focus on

- Under certain types of conditions, it is difficult to focus using auto focus. The green lamp on the monitor lights, allowing you to check if the focus is locked.

The green lamp blinks.
The subject cannot be brought into focus.

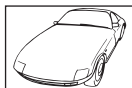

Subject with low contrast



Subject with an extremely bright area in the center of the frame

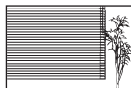

Subject without vertical lines

The green lamp lights, but the subject cannot be brought into focus.



Subjects at different distances

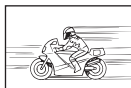

Fast-moving subject



Subject not in the center of the frame

In these cases, focus (focus lock) on an object with high contrast at the same distance as the intended subject, recompose your shot and then take the picture. If the subject has no vertical lines, hold the camera vertically and focus the camera using the focus lock function by pressing the shutter button halfway, and then return the camera to the horizontal position while keeping the button pressed halfway and take the picture.

Taking pictures without blurring

Hold the camera properly and press the shutter button gently.

Shoot with the  mode to avoid blurring.

The following factors may cause blurring.

- Shooting with the higher magnifications such as digital zoom or optical zoom.
- Shooting a dark subject with a low shutter speed.
- When you select the SCN mode which cannot use a flash or the SCN mode with a low shutter speed.

Taking pictures without the flash

The flash fires automatically when there is insufficient light. If the subject is too far away, the flash may have no effect. Here is how to take pictures without the flash in this type of situation.

Set the camera to mode

- The sensitivity of the CCD increases automatically, you can hold the camera and take pictures in darker places with the flash off.

 “ Shooting pictures using image blur reduction” (P.10)

Set the flash mode to (Flash off).

- The flash does not fire even in low light conditions.

 “ button Flash shooting” (P.13)

The picture is grainy

There are several factors that can cause the picture to appear grainy.

Using the digital zoom to take close-up pictures

- With the digital zoom, part of the image is cropped and enlarged. The greater the magnification, the grainier the picture appears.

 “DIGITAL ZOOM Zooming in on your subject” (P.18)



Pictures taken with , , , , or in SCN mode



- When pictures of a dark subject are taken with any of the above functions in SCN mode, noise reduction functions to create clearer images. If noise reduction does not function, the picture may appear grainy.

 “SCN (Scene) Shooting pictures by selecting a scene according to the situation” (P.21)

Taking pictures of a white beach or snow scene



- Often, bright subjects (such as snow) turn out darker than their natural colors. Adjust  toward [+] to make these subjects closer to their real shades. Conversely, when you are shooting dark subjects, it can be effective to adjust toward the [-]. Sometimes, using the flash may not produce the brightness (exposure) that was intended.

 “ button Changing picture brightness” (P.12)

- Take pictures with   in SCN mode. Suitable for taking pictures on a sunny day at the beach or in the snow.

 “SCN (Scene) Shooting pictures by selecting a scene according to the situation” (P.21)

Taking pictures of a subject against backlight

- Set the flash to  to activate fill-in-flash. You can shoot a subject against backlight without the face of the subject appearing dark. The  mode is effective not only for the shooting against the sun but for the shooting under artificial lighting such as the fluorescent light.

 “ button Flash shooting” (P.13)

Increasing the number of pictures that can be taken

There are two ways to record the pictures you take with this camera.

Recording pictures to the internal memory

- Pictures are recorded to the internal memory, and when the number of storable still pictures reaches 0, you must connect the camera to a computer to download the pictures, and then erase the pictures from the internal memory.

Using a card (xD-Picture Card) (optional)

- Pictures are recorded to the card when inserted in the camera. When the card is full, you must download the pictures to a computer, and then either erase the pictures from the card, or use a new card.
- Pictures are not recorded to the internal memory when a card is inserted in the camera. Pictures in the internal memory can be copied to the card using the [BACKUP] function.

 "BACKUP Copying pictures in the internal memory to the card" (P.29)
"The card" (P.71)

Number of the storable still pictures in the internal memory and on a card / Storable recording time

Still picture

Image quality	Image size	Number of storable still pictures	
		Internal memory	Card (Using a 128 MB card)
SHQ	FE-130/X-720/X-740: 2592 × 1944	5	34
	FE-140/X-725: 2816 × 2112	5	29
HQ	FE-130/X-720/X-740: 2592 × 1944	17	102
	FE-140/X-725: 2816 × 2112	14	86
SQ1	2048 × 1536	27	162
SQ2	640 × 480	226	1,330

Movie

Image quality	Image size	Recording time	
		Internal memory	Card (Using a 128 MB card)
HQ	320 × 240 (15 frames/sec.)	1 min. 5 sec.	6 min. 26 sec.
SQ	160 × 120 (15 frames/sec.)	4 min. 48 sec.	28 min. 21 sec.

Using a new card

- If you use a non-Olympus card or a card used for another application, such as for a computer, the message [CARD ERROR] is displayed. To use this card with this camera, use the [FORMAT] function to format the card.
-  "MEMORY FORMAT (FORMAT) Formatting the internal memory or card" (P.29)

Lamp indicators

This camera uses several lamps to indicate the camera status.

Lamp	Status
Self-timer lamp	The lamp lights for approximately 10 seconds, blinks for approximately 2 seconds, and then the picture is taken.
Card access lamp	<p>Blinking: A picture is being recorded, the camera is reading a movie, or images are being downloaded (when connected to a computer).</p> <ul style="list-style-type: none"> • Do not do any of the following while the card access lamp is blinking. Doing so may prevent the image data from being saved and render the internal memory or card unusable. <ul style="list-style-type: none"> • Open the camera's battery compartment/card cover • Remove the battery. • Connect or disconnect the AC adapter.
Green lamp on the monitor	<p>Lit: The focus and exposure are locked.</p> <p>Blinking: The focus is not locked.</p> <ul style="list-style-type: none"> • Release your finger from the shutter button, re-position the AF target mark on the subject and press the shutter button halfway again.

Extending the useful life of the battery

- Doing any of the following operations when not actually taking pictures can deplete the battery power.
 - Repeatedly pressing the shutter button halfway
 - Repeatedly using the zoom
- To save battery power, turn off the camera whenever it is not in use.

Functions that cannot be selected from menus

- Some items may not be selectable from the menus when using the arrow pad.
 - Items that cannot be set with the current shooting mode
 - Items that cannot be set because of the combination of the items that have already been set:
[S₁] and [FLASH MODE], etc.
- Some functions cannot be used when there is no card in the camera.
[PANORAMA], [FORMAT], [BACKUP], [PRINT ORDER] mode

Selecting the optimal image quality

An image quality expresses a combination of desired image size and compression level. Use the following examples to help determine the optimal image quality when shooting.

To print large images on full-size paper/To edit and process images on a computer

- [SHQ] or [HQ]

To print postcard-size images

- [SQ1]

To send as an e-mail attachment or post on a web site

- [SQ2]

 "IMAGE QUALITY Changing the image quality" (P.20)

Setting the current camera settings to its default

- To set the shooting mode settings which have been changed during use to default, use [RESET] function.
-  "RESET Resetting the settings to the default" (P.20)
- When the camera is turned off, all the shooting settings other than [IMAGE QUALITY] and [DIGITAL ZOOM] return to default.
[IMAGE QUALITY] and [DIGITAL ZOOM] settings will not return to default even when the camera is turned off.

Playback tips

Playing back the pictures stored in the internal memory

The card is inserted

- When the card is inserted to the camera, the pictures stored in the internal memory cannot be played back. Remove the card first, and play back the pictures.

Understanding the settings and other information of pictures taken

- Play back a picture, and press the **DISP./?** button. Press the **DISP./?** button repeatedly to change the amount of information displayed.
-  **DISP./?** button Changing the information display/Displaying the menu guide" (P.14)

Quickly displaying a desired picture

- Push the zoom lever toward **W** to view the multiple pictures in a list (index display) or in a calendar format (calendar display).
-  "Zoom lever Zooming while shooting/close-up playback" (P.11)

Viewing pictures on a computer

Viewing the entire picture on a computer screen

The size of the picture displayed on a computer screen changes depending on the computer settings. When the monitor setting is 1,024 × 768 and you are using Internet Explorer to view a picture with an image size of 2,048 × 1,536 at 100%, the entire picture cannot be viewed without scrolling. There are several ways you can view the entire picture on the computer screen.









View the picture using image browsing software







- Install the OLYMPUS Master software from the provided CD-ROM.

Change the monitor setting

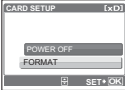
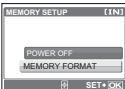
- The icons on the computer desktop may be rearranged. For details of changing the settings on the computer, refer to the computer's instruction manual.

When you get an error message on the camera...

Monitor indication	Possible cause	Corrective action
 CARD ERROR	There is a problem with the card.	This card cannot be used. Insert a new card.
 WRITE-PROTECT	Writing to the card is prohibited.	The recorded image has been protected (read-only) on a computer. Download the image to a computer and cancel the read-only setting.
 MEMORY FULL	The internal memory has no available memory and cannot store any new data.	Erase unwanted data. Before erasing, insert a card to back up all data or download important pictures to a computer.
 CARD FULL	The card has no available memory and cannot store any new data.	Replace the card or erase unwanted data. Before erasing, download important pictures to a computer.
 NO PICTURE	There are no pictures in the internal memory or on the card.	The internal memory or the card contains no pictures. Record pictures.
 PICTURE ERROR	There is a problem with the selected picture and it cannot be played back on this camera.	Use image processing software to view the picture on a computer. If that cannot be done, the image file is damaged.
 CARD-COVER OPEN	The card cover is open.	Close the card cover.
 BATTERY EMPTY	The battery is empty.	Replace the batteries with new ones, or charge the batteries.
 Y/M/D	When the camera is used for the first time or the battery has been removed for a long time, the date and time are on the factory default setting.	Set the date and time.

Monitor indication	Possible cause	Corrective action
	This card cannot be used in this camera. Or, the card is not formatted.	Format the card or replace. <ul style="list-style-type: none"> • Select [POWER OFF] and press OK. Insert a new card. • Select [FORMAT] ► [YES] and press OK. All data on the card is erased.
	There is an error in the internal memory.	Select [MEMORY FORMAT] ► [YES] and press OK . All data in the internal memory is erased.
 NO CONNECTION	The camera is not connected to the printer correctly.	Disconnect the camera and connect it again correctly.
 NO PAPER	There is no paper in the printer.	Load some paper in the printer.
 NO INK	The printer has run out of ink.	Replace the ink cartridge in the printer.
 JAMMED	The paper is jammed.	Remove the jammed paper.
SETTINGS CHANGED	The printer's paper tray has been removed or the printer has been operated while changing settings on the camera.	Do not operate the printer while changing settings on the camera.
 PRINT ERROR	There is a problem with the printer and/or camera.	Turn off the camera and printer. Check the printer and remedy any problems before turning the power on again.
 CANNOT PRINT	Pictures recorded on other cameras may not be printed on this camera.	Use a computer to print.

Functions available in shooting modes and scenes

Some functions cannot be set in certain shooting modes. For more details, refer to the table below.

Grayed out areas () in the SCN column indicate that to enable the shooting scene in SCN mode, there are restrictions to the functions that can be set.













☞ “Functions with restrictions in shooting scenes” (P.66)

Functions available in shooting modes

Function	Shooting mode								
	AUTO							SCN	
	✓			—		✓			✓
	✓			—		✓			✓
				✓					✓
Flash				✓					—
Information display (DISP)				✓					
Optical zoom				✓					✓
SCN				—				✓	—
				✓					
IMAGE QUALITY		✓			✓*	✓			✓
DIGITAL ZOOM				✓					—
PANORAMA				✓					—
RESET				✓					
MEMORY FORMAT (FORMAT)				✓					
BACKUP				✓					
				✓					
COLOR				✓					
PIXEL MAPPING				✓					
				✓					
				✓					
VIDEO OUT				✓					

* Only [2048 × 1536] and [640 × 480] are available.

Functions with restrictions in shooting scenes

Function	Scene									
										
	✓		—		✓		—	✓		—
	✓		—		✓		—	✓		—
	✓									
Flash	✓		—		✓		—			
Optical zoom	✓			—			✓			
IMAGE QUALITY	✓	*1		✓		✓		*1		*2
DIGITAL ZOOM	✓			—			✓			
PANORAMA	✓									

*1 Only [2048 × 1536] and [640 × 480] are available.

*2 Only [640 × 480] are available.

Glossary of terms

CCD (Charge-Coupled Device)

This converts light passing through the lens into electrical signals. On this camera, light is picked up and converted into RGB signals to build a single image.

DCF (Design Rule for Camera File System)

A standard for image files by the Japan Electronics and Information Technology Industries Association (JEITA).

DPOF (Digital Print Order Format)

This is for saving desired print settings on digital cameras. By entering which images to print and the number of copies of each, the user can easily have the desired images printed by a printer or print lab that supports the DPOF format.

EV (Exposure Value)

A system for measuring exposure. EV0 is when the aperture is at F1 and the shutter speed is 1 second. The EV then increases by 1 each time the aperture increases by one F stop or the shutter speed increases by one increment. EV can also be used to indicate brightness and ISO.

Exposure

The amount of light used to capture an image. The exposure is determined by the time the shutter is open (shutter speed) and the amount of light that passes through the lens (aperture).

Image size

The size of an image expressed by the number of pixels that make up the image. For instance, a picture taken with an image size of 640 × 480 fills the computer screen when the monitor setting is 640 × 480. However, if the monitor setting is 1,024 × 768, the picture only takes up part of the screen.

JPEG (Joint Photographic Experts Group)

A compression format for still images. Photographs (pictures) taken using this camera are recorded onto the card in JPEG format. By downloading these images to a computer, users can edit them using graphics application software or view the images using an Internet web browser.

Noise reduction

When shooting in dark places, shutter speeds become slower as there is less light focused on the CCD. During long exposures, signals are generated by parts of the CCD where no light is focused and are recorded on the picture as noise. When noise reduction works, the camera automatically reduces the noise to produce clearer images.

NTSC (National Television Systems Committee) / PAL (Phase Alternating Line)

Television formats. NTSC is mainly used in Japan, North America and Korea. PAL is mainly used in Europe and China.

PictBridge

A standard for connecting digital cameras and printers of different makers and printing out pictures directly.

Pixels

A pixel is the smallest unit (dot) used to make up an image. Clear large-sized printed images require millions of pixels.

Sleep mode

A mode designed to save battery life. The camera automatically enters the sleep mode if you do not operate it for a certain time. To exit the sleep mode, use any button on the camera (shutter button, arrow pad, etc.).

TFT (Thin-Film Transistor) Color Monitor

A transistor color monitor constructed using thin-film technology.

Camera care

Cleaning the camera

Exterior:

- Wipe gently with a soft cloth. If the camera is very dirty, soak the cloth in mild soapy water and wring well. Wipe the camera with the damp cloth and then dry it with a dry cloth. If you have used the camera at the beach, use a cloth soaked in clean water and wrung well.

Monitor:

- Wipe gently with a soft cloth.

Lens:

- Blow dust off the lens with a commercial blower, then wipe gently with a lens cleaner.

! Note

- Do not use strong solvents such as benzene or alcohol, or chemically treated cloth.
- Mold may form on the lens surface if the lens is left dirty.

Storage

- When storing the camera for extended periods of time, remove the battery, AC adapter and card, and keep it in a cool, dry place that is well ventilated.
- Periodically insert the battery and test the camera functions.

! Note

- Avoid leaving the camera in places where chemical products are handled since this may result in corrosion.

The battery

- In addition to the batteries provided with the camera, the following types of battery can be used. Choose the power source best suited to the situation.

AA alkaline batteries/ Oxyride batteries

The number of pictures that you can take may vary considerably depending on the battery manufacturer and shooting conditions.

AA NiMH batteries (rechargeable batteries)

Olympus NiMH batteries are rechargeable and economical. For details, refer to the instruction manual for your charger.

- **Lithium battery packs (CR-V3) and AA manganese (zinc-carbon) batteries cannot be used.**
- Power consumption by the camera varies depending on which functions are used.
- Power is consumed continuously during the conditions described below causing batteries to become exhausted quickly.
 - The zoom is used repeatedly.
 - The shutter button is pressed halfway repeatedly in shooting mode, activating the auto focus.
 - The monitor is left on for an extended period of time.
 - The camera is connected to a computer or printer.
- The battery life varies greatly depending on the type of battery, manufacturer, shooting conditions, etc. Because of this, there may be cases where the camera turns itself off without displaying the battery level warning, or displays the battery level warning sooner than usual.

Useful use of the accessories

The card

Pictures can be recorded on the optional xD-Picture Card.

The internal memory and card are the camera's media for recording pictures, similar to film in a film camera.

Pictures recorded to the internal memory or card can be easily erased on the camera or processed using a computer.

Unlike portable storage media, the internal memory cannot be removed or exchanged.

The number of recordable pictures can be increased by using a card with a larger capacity.

- ① Index area
You can use this space to write the contents of the card.

- ② Contact area
The part where the data transferred from the camera enters the card.

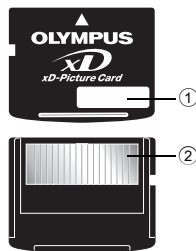

Compatible cards

xD-Picture Card (16MB – 1GB)

Using the internal memory or card

You can confirm on the monitor whether the internal memory or card is being used during shooting and playback operations.

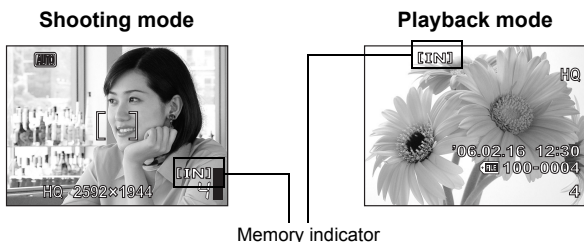

Inserting and removing the card

- 1 Turn off the camera.
- 2 Open the battery compartment/card cover.

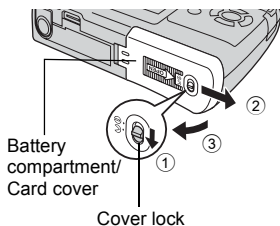

Inserting the card

- 3 Orient the card, and insert it into the card slot as shown in the illustration.

- Insert the card straight in.
- Insert the card until it clicks into place.

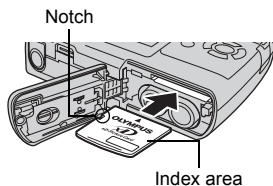

Removing the card

- 3 Push the card all the way in and release slowly.

- The card protrudes slightly and stops.

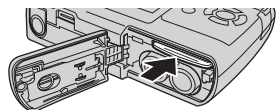

- Grasp the card and remove.

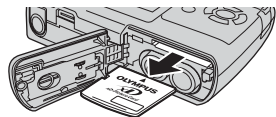

- 4 Close the battery compartment/card cover.

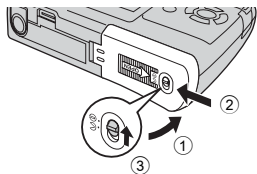

! Note

- The card access lamp blinks while the camera is reading the images. Reading of images may take some time. Do not open the Battery compartment/ Card cover while the card access lamp is blinking. Doing so may damage the data in the internal memory or the card and render the internal memory or card unusable.

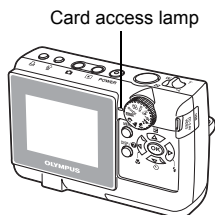

AC adapter

An AC adapter is useful for time-consuming tasks such as image downloads to a computer or when running a slideshow for a long period of time.

To use the AC adapter with this camera, the optional multi-adapter (CB-MA1) is necessary. Do not use any other AC adapter with this camera.

! Note

- Do not remove or load the battery or connect or disconnect the AC adapter or multi-adapter while the camera is on or the camera is connected to the other equipment. Doing so could affect the camera's internal settings or functions.
- The AC adapter can be used within the range of AC 100 V to AC 240 V (50/60 Hz). When using the shape of abroad, you may need a plug adapter to convert the plug to match the AC wall outlet. For details, ask at your local electrical shop or travel agent.
- Do not use travel voltage converters as they could damage the AC adapter.
- Be sure to read the instruction manual for the AC adapter.

Safety Precautions

Caution for Usage Environment

- To protect the high-precision technology contained in this product, never leave the camera in the places listed below, no matter if in use or storage:
 - Places where temperatures and/or humidity are high or go through extreme changes. Direct sunlight, beaches, locked cars, or near other heat sources (stove, radiator, etc.) or humidifiers.
 - In sandy or dusty environments.
 - Near flammable items or explosives.
 - In wet places, such as bathrooms or in the rain. When using products with weatherproof designs, read their manuals as well.
 - In places prone to strong vibrations.
- Never drop the camera or subject it to severe shocks or vibrations.
- When mounted on a tripod, adjust the position of the camera with the tripod head. Do not twist the camera.
- Do not touch electric contacts on cameras.
- Do not leave the camera pointed directly at the sun. This may cause lens or shutter curtain damage, color failure, ghosting on the CCD, or may possibly cause fires.
- Do not push or pull severely on the lens.
- Before storing the camera for a long period, remove the battery. Select a cool, dry location for storage to prevent condensation or mold from forming inside the camera. After storage, test the camera by turning it on and pressing the shutter release button to make sure that it is operating normally.
- Always observe the operating environment restrictions described in the camera's manual.

Battery Handling Precautions

- Olympus NiMH batteries (included in some areas) are intended for use only with Olympus digital cameras. Never use these batteries with any other device.
- Always charge NiMH batteries (included in some areas) before using them for the first time, or if they have not been used for a long period.
- Always charge sets of batteries (included in some areas) (2 or 4) together.
- Do not use alkaline batteries unless it is absolutely necessary. In some cases, alkaline batteries may have a shorter service life than NiMH battery packs. Alkaline battery performance is limited, especially at low temperatures. The use of NiMH batteries is recommended.
- CR-V3 lithium battery packs and AA manganese (Zinc-Carbon) batteries cannot be used with this camera.
- When operating the camera with battery power at low temperatures, try to keep the camera and spare batteries as warm as possible. Batteries which run down at low temperatures may be restored after they are warmed at room temperature.
- Recommended temperature ranges for NiMH batteries:
 - Operation.....0°C to 40°C (32°F to 104°F)
 - Charge.....0°C to 40°C (32°F to 104°F)
 - Storage.....-20°C to 30°C (-4°F to 86°F)

- Using, charging, or storing the batteries outside these ranges could shorten battery life or affect battery performance. Always unload the batteries from the camera before storing the camera for a long period.
- Before using NiMH or NiCd batteries, always read the provided instructions.
- The number of pictures you can take may vary depending on the shooting conditions or batteries.
- Before going on a long trip, and especially before traveling abroad, purchase an ample supply of extra batteries. The recommended batteries may be difficult to obtain while traveling.

LCD Monitor

- Do not push the monitor forcibly; otherwise the image may become vague, resulting in a playback mode failure or damage to the monitor.
- A strip of light may appear on the top/bottom of the monitor, but this is not a malfunction.
- When a subject is viewed diagonally in the camera, the edges may appear zigzagged on the monitor. This is not a malfunction; it will be less noticeable in playback mode.
- In places subject to low temperatures, the LCD monitor may take a long time to turn on or its color may change temporarily. When using the camera in extremely cold places, it is a good idea to occasionally place it in a warm place. An LCD monitor exhibiting poor performance due to low temperatures will recover in normal temperatures.
- The LCD used for the monitor is made with high-precision technology. However, black spots or bright spots of light may appear constantly on the LCD Monitor. Due to its characteristics or the angle at which you are viewing the monitor, the spot may not be uniform in color and brightness. This is not a malfunction.

Legal and Other Notices

- Olympus makes no representations or warranties regarding any damages, or benefit expected by using this unit lawfully, or any request from a third person, which are caused by the inappropriate use of this product.
- Olympus makes no representations or warranties regarding any damages or any benefit expected by using this unit lawfully which are caused by erasing picture data.

Disclaimer of Warranty

- Olympus makes no representations or warranties, either expressed or implied, by or concerning any content of these written materials or software, and in no event shall be liable for any implied warranty of merchantability or fitness for any particular purpose or for any consequential, incidental or indirect damages (including but not limited to damages for loss of business profits, business interruption and loss of business information) arising from the use or inability to use these written materials or software or equipment. Some countries do not allow the exclusion or limitation of liability for consequential or incidental damages, so the above limitations may not apply to you.
- Olympus reserves all rights to this manual.

Warning

Unauthorized photographing or use of copyrighted material may violate applicable copyright laws. Olympus assumes no responsibility for unauthorized photographing, use or other acts that infringe upon the rights of copyright owners.

Copyright Notice

All rights reserved. No part of these written materials or this software may be reproduced or used in any form or by any means, electronic or mechanical, including photocopying and recording or the use of any type of information storage and retrieval system, without the prior written permission of Olympus. No liability is assumed with respect to the use of the information contained in these written materials or software, or for damages resulting from the use of the information contained therein. Olympus reserves the right to alter the features and contents of this publication or software without obligation or advance notice.

FCC Notice

• Radio and Television Interference

Changes or modifications not expressly approved by the manufacturer may void the user's authority to operate this equipment. This equipment has been tested and found to comply with the limits for a Class B digital device, pursuant to Part 15 of the FCC Rules. These limits are designed to provide reasonable protection against harmful interference in a residential installation.

This equipment generates, uses, and can radiate radio frequency energy and, if not installed and used in accordance with the instructions, may cause harmful interference to radio communications.

However, there is no guarantee that interference will not occur in a particular installation. If this equipment does cause harmful interference to radio or television reception, which can be determined by turning the equipment off and on, the user is encouraged to try to correct the interference by one or more of the following measures:

- Adjust or relocate the receiving antenna.
- Increase the distance between the camera and receiver.
- Connect the equipment to an outlet on a circuit different from that to which the receiver is connected.
- Consult your dealer or an experienced radio/TV technician for help. Only the OLYMPUS-supplied USB cable should be used to connect the camera to USB enabled personal computers (PC).

Any unauthorized changes or modifications to this equipment would void the user's authority to operate it.

Index

button (Erase)	13
button (Exposure compensation)	12
button (Flash mode)	13
button (Macro)	12
button (OK)	12
button (Playback mode)	9
button (Print)	13, 34
button (Self-timer)	13
button (Shooting mode)	9

A

AC adapter	73
ALL ERASE	25
ALL INDEX	35
ALL PRINT	35
All-frame reservation	41
Arrow pad ()	12
AUCTION	21
AUTO (Flash)	13
Auto (Shooting) AUTO	9
Auto focus	57
AVAILABLE LIGHT	21

B

BACKUP	29
Battery	70, 74
Battery compartment/ Card cover	72
BEACH	21
BEHIND GLASS	21
BLACK & WHITE	26
BRIGHTNESS	28

C

CALENDAR (Edit)	27
CALENDAR (Playback)	25
Calendar display	11
CAMERA MENU	18
CANDLE	21
Card	19, 29, 71

Card access lamp	50, 60, 73
CCD	30, 67
Close-up playback	11
COLOR	30
Compression	20
Connector cover	31, 33, 48
Cover lock	72
CUISINE	21
CUSTOM PRINT	35

D









D IMAGE STABILIZATION ()	10
Date and time	30
DCF	67
DIGITAL ZOOM	18
Direct printing	33
DISP./? button	14
DOCUMENTS	21
DPOF	39, 67









E

EASY PRINT	33
EDIT	26
ERASE	25
Error message	63
EV	67
Exposure	8, 67
Exposure compensation	12

F











FADER	23
Fill-in flash	13
FIREWORKS	21
Flash	13
Flash charge	55
Flash mode	13
Flash off	13
Focus	8
Focus lock	8
FORMAT	29

Formatting	29
FRAME	26
G	
Green lamp	8, 60
GUIDE SHOOTING	10
H	
HQ	20
I	
IMAGE QUALITY	20
Image size	20, 67
INDEX	25
Index display 	11
INDOOR 	21
Internal memory	29, 71
J	
JPEG	67
L	
LANDSCAPE + PORTRAIT 	9
LANDSCAPE 	9
LAYOUT	27
M	
Macro mode 	12
MEMORY FORMAT 	29
Memory gauge	56
Menu	15
MENU button	12, 15
Menu guide	14
Mode dial	9
Monitor	8
Monitor brightness adjustment 	30
MOVIE PLAY	24
MULTI PRINT	35
Multi-adaptor	73
Multi-connector	31, 33, 48
MUSEUM 	21

N	
NIGHT + PORTRAIT 	21
NIGHT SCENE 	9
NiMH batteries	70
Noise reduction	67
NORMAL (COLOR)	30
NORMAL (Monitor)	30
NORMAL (SLIDESHOW)	23
NTSC	31, 67
Number of storable still pictures	59
O	
OLYMPUS Master	19, 43
Operation guide	16
Optical zoom	18
P	
PAL	31, 67
PANORAMA	19
PC	48
PictBridge	33, 67
Picture rotation 	23
PIXEL MAPPING	30
Pixels	68
PLAYBACK MENU	22
Playback mode 	9, 22
Playback on a TV	31
Playing time	24
PORTRAIT 	9
POWER button	8
Press fully	8
Press halfway	8
PRINT ORDER 	28, 35, 39
Protect 	22
R	
Recording movie 	10
Recording time	59
REDEYE FIX	26
Red-eye reduction flash 	13

Remaining recording time	10
RESET	20
Resizing 	26

S

SATURATION	28
SCN (Scene)	9, 21
SEL. IMAGE 	25
Selecting a language 	29
SELF PORTRAIT 	21
Self-timer 	13
Self-timer lamp	13, 60
SEPIA	26
SETUP	29
Shooting mode 	8, 9, 18
Shooting still picture	8
SHQ	20
Shutter button	8
Single-frame playback	11
Single-frame reservation 	40
Sleep mode	55, 68
SLIDE	23
SLIDESHOW	23
SNOW 	21
SPORT 	9
SQ	20
SQ1	20
SQ2	20
STANDARD	33
SUNSET 	21
Super macro mode 	12

T

TFT	68
TITLE	27
Top menu	15
Total recording time	24
Trimming 	26, 37

U

USB cable	33, 43, 48, 54
USB driver	44, 54

V

Video cable	31
VIDEO OUT	31

X

xD-Picture Card	19, 71
-----------------	--------

Z

Zoom	11
ZOOM (SLIDE SHOW)	23
Zoom bar	18
Zoom lever	11, 55

OLYMPUS®

<http://www.olympus.com/>

OLYMPUS IMAGING CORP.

Shinjuku Monolith, 3-1 Nishi-Shinjuku 2-chome, Shinjuku-ku, Tokyo, Japan

OLYMPUS IMAGING AMERICA INC.

Two Corporate Center Drive, P.O. Box 9058, Melville, NY 11747-9058, U.S.A. Tel. 631-844-5000

Technical Support (USA)

24/7 online automated help: <http://www.olympusamerica.com/support>

Phone customer support: Tel. 1-888-553-4448 (Toll-free)

Our phone customer support is available from 8 am to 10 pm

(Monday to Friday) ET

E-Mail: distec@olympus.com

Olympus software updates can be obtained at: <http://www.olympus.com/digital>

OLYMPUS IMAGING EUROPA GMBH

Premises: Wendenstrasse 14-18, 20097 Hamburg, Germany

Tel: +49 40-23 77 3-0 / Fax: +49 40-23 07 61

Goods delivery: Bredowstrasse 20, 22113 Hamburg, Germany

Letters: Postfach 10 49 08, 20034 Hamburg, Germany

European Technical Customer Support:

Please visit our homepage <http://www.olympus-europa.com>

or call our TOLL FREE NUMBER* : **00800 - 67 10 83 00**

for Austria, Belgium, Denmark, Finland, France, Germany, Italy, Luxemburg, Netherlands,
Norway, Portugal, Spain, Sweden, Switzerland, United Kingdom

* Please note some (mobile) phone services providers do not permit access or request an
additional prefix to +800 numbers.

For all European Countries not listed and in case that you can't get connected
to the above mentioned number, please make use of the following

CHARGED NUMBERS: +49 180 5 - 67 10 83 or +49 40 - 237 73 899

Our Technical Customer Support is available from 9 am to 6 pm MET (Monday to Friday)