

The Samsung logo is located in the top left corner of the page. It consists of the word "SAMSUNG" in a bold, white, sans-serif font, enclosed within a white oval shape that has a slight gradient and shadow effect.

User Manual

PL150/PL151

This user manual includes detailed usage instructions for your camera. Please read this manual thoroughly.

 [Click a topic](#)

Common questions

Quick reference

Contents

Basic functions

Extended functions

Shooting options

Playback/Editing

Appendixes

Index

Health and safety information

Always comply with the following precautions and usage tips to avoid dangerous situations and ensure peak performance of your camera.



Warning—situations that could cause injury to yourself or others



Caution—situations that could cause damage to your camera or other equipment



Note—notes, usage tips, or additional information



Safety warnings

Do not use your camera near flammable or explosive gases and liquids

Do not use your camera near fuels, combustibles, or flammable chemicals. Do not store or carry flammable liquids, gases, or explosive materials in the same compartment as the camera or its accessories.

Keep your camera away from small children and pets

Keep your camera and all accessories out of the reach of small children and animals. Small parts may cause choking or serious injury if swallowed. Moving parts and accessories may present physical dangers as well.

Prevent damage to subjects' eyesight

Do not use the flash in close proximity (closer than 1 m/3 ft) to people or animals. Using the flash too close to your subject's eyes can cause temporary or permanent damage.

Handle and dispose of batteries and chargers with care

- Use only Samsung-approved batteries and chargers. Incompatible batteries and chargers can cause serious injuries or damage to your camera.
- Never dispose of batteries in a fire. Follow all local regulations when disposing of used batteries.
- Never place batteries or cameras on or in heating devices, such as microwave ovens, stoves, or radiators. Batteries may explode when overheated.
- Do not use a damaged power supply cord, plug, or loose outlet when charging batteries. This may cause a fire or electric shock.



CAUTION

Safety precautions

Handle and store your camera carefully and sensibly

- Do not allow your camera to get wet—liquids can cause serious damage. Do not handle your camera with wet hands. Water damage to your camera can void your manufacturer's warranty.
- Do not expose the camera to direct sunlight or high temperatures for an extended period of time. Prolonged exposure to sunlight or extreme temperatures can cause permanent damage to your camera's internal components.
- Avoid using or storing your camera in dusty, dirty, humid, or poorly-ventilated areas to prevent damage to moving parts and internal components.
- Remove the batteries from your camera when storing it for an extended period of time. Installed batteries may leak or corrode over time and cause serious damage to your camera.
- Protect your camera from sand and dirt when using it on beaches or in other similar areas.
- Protect your camera from impact, rough handling, and excessive vibration to avoid serious damage.
- Exercise caution when connecting cables or adapters and installing batteries and memory cards. Forcing the connectors, improperly connecting cables, or improperly installing batteries and memory cards can damage ports, connectors, and accessories.

- Do not insert foreign objects into any of your camera's compartments, slots, or access points. Damage due to improper use may not be covered by your warranty.
- Do not swing your camera by the strap. This may cause injury to yourself or others.
- Do not paint your camera, as paint can clog moving parts and prevent proper operation.
- Paint or metal on the outside of the camera may cause allergies, itchy skin, eczema, or swelling for people with sensitive skin. If you have experience any of these symptoms, stop using the camera immediately and consult a doctor.

Protect batteries, chargers, and memory cards from damage

- Avoid exposing batteries or memory cards to very cold or very hot temperatures (below 0° C/32° F or above 40° C/104° F). Extreme temperatures can reduce the charging capacity of your batteries and can cause memory cards to malfunction.
- Prevent batteries from making contact with metal objects, as this can create a connection between the + and – terminals of your battery and lead to temporary or permanent battery damage. Also, this may cause a fire or electric shock.
- Prevent memory cards from making contact with liquids, dirt, or foreign substances. If dirty, wipe the memory card clean with a soft cloth before inserting in your camera.
- Turn off the camera when inserting or removing the memory card.

- Do not bend, drop, or subject memory cards to heavy impact or pressure.
- Do not use memory cards that have been formatted by other cameras or by a computer. Reformat the memory card with your camera.
- Never use a damaged charger, battery, or memory card.

Use only Samsung-approved accessories

Using incompatible accessories may damage your camera, cause injury, or void your warranty.

Protect your camera's lens

- Do not expose the lens to direct sunlight, as this may discolor the image sensor or cause it to malfunction.
- Protect your lens from fingerprints and scratches. Clean your lens with a soft, clean, debris-free lens cloth.



Important usage information

Allow only qualified personnel to service your camera

Do not allow unqualified personnel to service the camera or attempt to service the camera yourself. Any damage that results from unqualified service is not covered by your warranty.

Ensure maximum battery and charger life

- Overcharging batteries may shorten battery life. After charging is finished, disconnect the cable from your camera.
- Over time, unused batteries will discharge and must be recharged before use.
- Disconnect chargers from power sources when not in use.
- Use batteries only for their intended purpose.

Exercise caution when using the camera in humid environments

When transferring the camera from a cold environment to a warm and humid one, condensation can form on the delicate electronic circuitry and memory card. In this situation, wait for at least 1 hour until all moisture has evaporated before using the camera.

Check that the camera is operating properly before use

The manufacturer takes no responsibility for any loss of files or damage that may result from camera malfunction or improper use.

Copyright information

- Microsoft Windows and the Windows logo are registered trademarks of the Microsoft Corporation.
- Mac is a registered trademark of the Apple Corporation.
- HDMI, the HDMI logo and the term "High Definition Multimedia Interface" are trademarks or registered trademarks of HDMI Licensing LLC.

- Camera specifications or contents of this manual may be changed without prior notice due to upgrade of camera functions.
- For Open Source License information, refer to the "OpenSourceInfo.pdf" in the provided CD-ROM.

Organization of the user manual

Basic functions 11

Learn about your camera's layout, icons, and basic functions for shooting.

Extended functions 28

Learn how to take a photo by selecting a mode and how to record a video or voice memo.

Shooting options 41

Learn about the options you can set in shooting mode.









Playback/Editing 61

Learn how to play back photos, videos, or voice memos and edit photos or videos. Also, learn how to connect your camera to your computer, photo printer, TV, or HDTV.

Appendixes 84

Refer to settings, error messages, specifications, and maintenance tips.

Indications used in this manual

Shooting mode	Indication
Smart Auto	
Auto	
Program	
DUAL IS	
Beauty Shot	
Night	
Scene	
Movie	

Shooting mode icons

These icons indicate that a function is available in the corresponding modes. The **SCN** mode may not support functions for all scenes.

e.g.)

Adjusting the exposure manually

(EV) 

Depending on the intensity of the ambient light, your photos may be too bright or dark. In these cases, you can adjust the exposure to get a better photo.



Darker (-)





Neutral (0)



Brighter (+)

Available in the Program, DUAL IS, and Movie modes

Icons used in this manual

Icon	Function
	Additional information
	Safety warnings and precautions
[]	Camera buttons; for example: [Shutter] (represents the shutter button)
()	Page number of related information
→	The order of options or menus you must select to perform a step; for example: Select Shooting → White Balance (represents select Shooting , and then White Balance).
*	Annotation

Abbreviations used in this manual

Abbreviation	Definition
ACB	Auto Contrast Balance
AEB	Auto Exposure Bracket
AF	Auto Focus
DIS	Digital Image Stabilization
DPOF	Digital Print Order Format
EV	Exposure Value
OIS	Optical Image Stabilization
WB	White Balance

Expressions used in this manual

Pressing the shutter

- Half-press [**Shutter**]: press the shutter halfway down
- Press [**Shutter**]: press the shutter all the way down

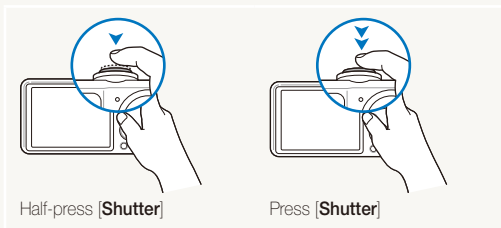

Exposure (Brightness)

The amount of light that enters your camera determines the exposure. You can alter the exposure with shutter speed, aperture value, and ISO speed. By altering the exposure, your photos will be darker or lighter.

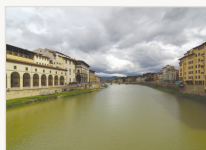

Normal exposure

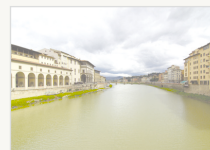

Overexposure (too bright)





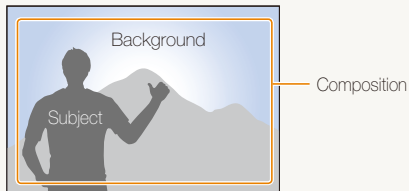







Subject, background, and composition

- **Subject**: the main object of a scene, such as a person, animal, or still life
- **Background**: the objects around the subject
- **Composition**: the combination of a subject and background



Common questions

You can get answers to common questions. Solve problems easily by setting shooting options.

	The subject's eyes appear red.	<p>This is caused by a reflection from the camera flash.</p> <ul style="list-style-type: none">• Set the flash option to  Red-eye or  Red-eye Fix. (p. 45)• If the photo has already been taken, select  Red-eye Fix in the edit menu. (p. 73)
	Photos have dust spots.	<p>Dust particles floating in the air may be captured in photos when using the flash.</p> <ul style="list-style-type: none">• Turn off the flash or avoid taking photos in a dusty place.• Set ISO speed options. (p. 46)
	Photos are blurred.	<p>This may be caused by taking photos in low light conditions or holding the camera incorrectly.</p> <ul style="list-style-type: none">• Press [Shutter] halfway down to make sure the subject is focused. (p. 26)• Use the  DUAL mode. (p. 33)
	Photos are blurred when shooting at night.	<p>As the camera tries to let in more light, the shutter speed slows. This can make it difficult to steady the camera and may result in camera shake.</p> <ul style="list-style-type: none">• Rotate the mode dial to . (p. 31)• Turn on the flash. (p. 45)• Set ISO speed options. (p. 46)• Use a tripod to prevent your camera from shaking.
	Subjects come out too dark because of backlighting.	<p>When the light source is behind the subject or when there is a high contrast between the light and dark areas, the subject may come out shaded.</p> <ul style="list-style-type: none">• Avoid shooting in front of the sun.• Select  Backlight in the SCN mode. (p. 30)• Set the flash option to  Fill in. (p. 45)• Set the Auto Contrast Balance (ACB) option. (p. 54)• Adjust the exposure. (p. 54)• Set the metering option to  Spot if a bright subject is in the center of the frame. (p. 55)

Quick reference



Taking photos of people

- **SCN** mode > Portrait ▶ 30
-  mode ▶ 32
- Self-portrait mode ▶ 37
- Children mode ▶ 38
- Couple mode ▶ 38
- Red-eye, Red-eye Fix (to prevent or correct red-eye) ▶ 45
- Face Detection ▶ 50



Taking photos at night or in the dark

- **SCN** mode > Sunset, Dawn, Fireworks ▶ 30
-  mode ▶ 31
- Flash options ▶ 45
- ISO speed (to adjust the sensitivity to light) ▶ 46



Taking action photos

- Continuous, Motion Capture ▶ 57



Taking photos of text, insects, or flowers

- **SCN** mode > Close Up, Text ▶ 30
- Macro, Auto Macro (to take close-up photos) ▶ 47
- White Balance (to change the color tone) ▶ 55



Adjusting the exposure (brightness)

- ISO speed (to adjust the sensitivity to light) ▶ 46
- EV (to adjust exposure) ▶ 54
- ACB (to compensate for subjects against bright backgrounds) ▶ 54
- Metering ▶ 55
- AEB (to take three photos of the same scene with different exposures) ▶ 57



Applying a different effect

- Photo styles (to apply tones) ▶ 58
- Smart filter effects ▶ 59
- Image adjustment (to adjust saturation, sharpness, or contrast) ▶ 60



Reducing camera shake

- Optical Image Stabilization (OIS) ▶ 24
-  mode ▶ 33

- Viewing files by category in Smart Album ▶ 63
- Deleting all files on the memory card ▶ 65
- Viewing files as a slide show ▶ 67
- Viewing files on a TV or HDTV ▶ 75
- Connecting your camera to a computer ▶ 77
- Adjusting sound and volume ▶ 86
- Adjusting the brightness of the display ▶ 86
- Changing the display language ▶ 86
- Setting the date and time ▶ 87
- Formatting the memory card ▶ 87
- Troubleshooting ▶ 96

Contents

Basic functions	11	Recording a video	34
Unpacking	12	Using the Smart Scene Detection mode	36
Camera layout	13	Taking photos with the front display	37
Inserting the battery and memory card	15	Using the Self-portrait mode	37
Charging the battery and turning your camera on	16	Using the Couple mode	38
Charging the battery	16	Using the Children mode	38
Turning on your camera	16	Recording a video with the front display	39
Performing the initial setup	17	Recording voice memos	40
Learning icons	18	Recording a voice memo	40
Selecting options	19	Adding a voice memo to a photo	40
Setting the display and sound	21	Shooting options	41
Changing the display type	21	Selecting a resolution and quality	42
Setting the sound	21	Selecting a resolution	42
Taking photos	22	Selecting image quality	42
Turning on the front display	23	Using the timer	43
Zooming	23	Shooting in the dark	45
Reducing camera shake (OIS)	24	Preventing red-eye	45
Tips for getting a clearer photo	26	Using the flash	45
Extended functions	28	Adjusting the ISO speed	46
Shooting modes	29	Changing the camera's focus	47
Using the Smart Auto mode	29	Using macro	47
Using the Scene mode	30	Using auto focus	47
Using the frame guide	31	Using tracking auto focus	48
Using the Night mode	31	Adjusting the focus area	49
Using the Beauty Shot mode	32	Using face detection	50
Using the DUAL IS mode	33	Detecting faces	50
Using the Program mode	34	Taking a smile shot	51
		Detecting eye blinking	51

Using smart face recognition	52	Transferring files to your computer (for Windows)	77
Registering faces as your favorites (My Star)	53	Transferring files using Intelli-studio	78
Adjusting brightness and color	54	Transferring files by connecting the camera as a removable disk	80
Adjusting the exposure manually (EV)	54	Disconnecting the camera (for Windows XP)	81
Compensating for backlighting (ACB)	54	Transferring files to your computer (for Mac)	82
Changing the metering option	55	Printing photos with a photo printer (PictBridge)	83
Selecting a light source (White balance)	55		
Using burst modes	57		
Improving your photos	58	Appendixes	84
Applying photo styles	58	Camera settings menu	85
Applying smart filter effects	59	Accessing the settings menu	85
Adjusting your photos	60	Sound	86
		Display	86
Playback/Editing	61	Settings	87
Playing back	62	Error messages	90
Starting Playback mode	62	Camera maintenance	91
Viewing photos	66	Cleaning your camera	91
Playing a video	68	About memory cards	92
Playing voice memos	69	About the battery	93
Editing a photo	70	Before contacting a service center	96
Resizing photos	70	Camera specifications	99
Rotating a photo	70	Index	104
Applying photo styles	71		
Applying smart filter effects	72		
Correcting exposure problems	73		
Creating a print order (DPOF)	74		
Viewing files on a TV or HDTV	75		

Basic functions

Learn about your camera's layout, icons, and basic functions for shooting.

Unpacking	12
Camera layout	13
Inserting the battery and memory card	15
Charging the battery and turning your camera on	16
Charging the battery	16
Turning on your camera	16
Performing the initial setup	17
Learning icons	18
Selecting options	19
Setting the display and sound	21
Changing the display type	21
Setting the sound	21
Taking photos	22
Turning on the front display	23
Zooming	23
Reducing camera shake (OIS)	24
Tips for getting a clearer photo	26

Unpacking

Check your product box for the following items.

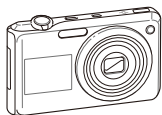

Camera



AC adapter/USB cable

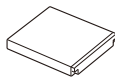

Rechargeable battery



Strap



User Manual CD-ROM

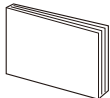

Quick Start Manual



The illustrations may differ from your actual items.

Optional accessories



Camera case



Memory card
(microSD™)

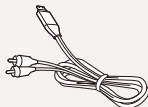

AV cable

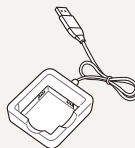

Battery charger

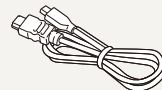

HDMI cable

Camera layout

Before you start, familiarize yourself with your camera's parts and their functions.

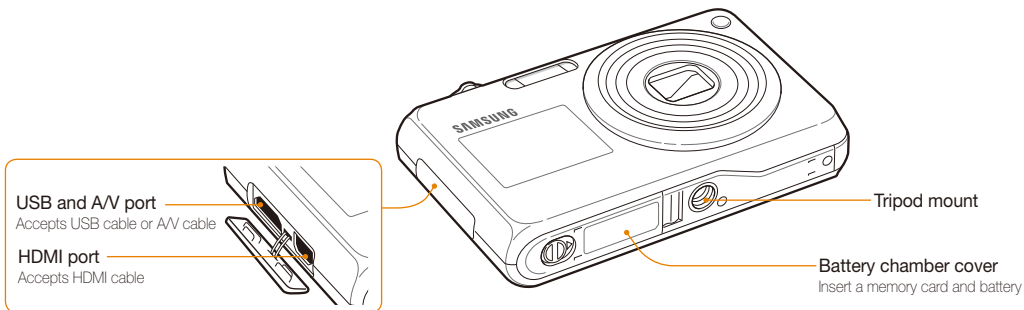
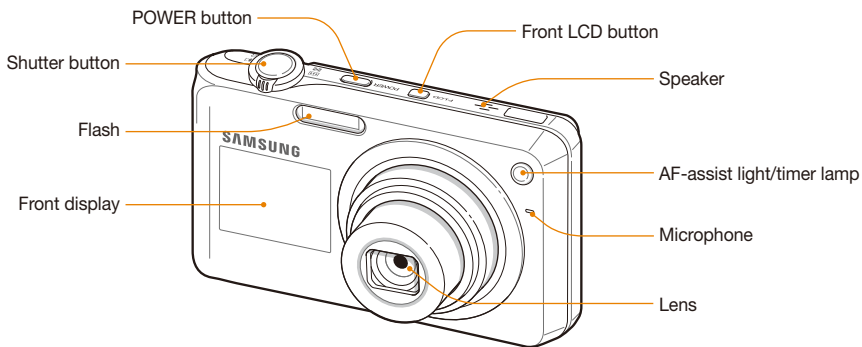

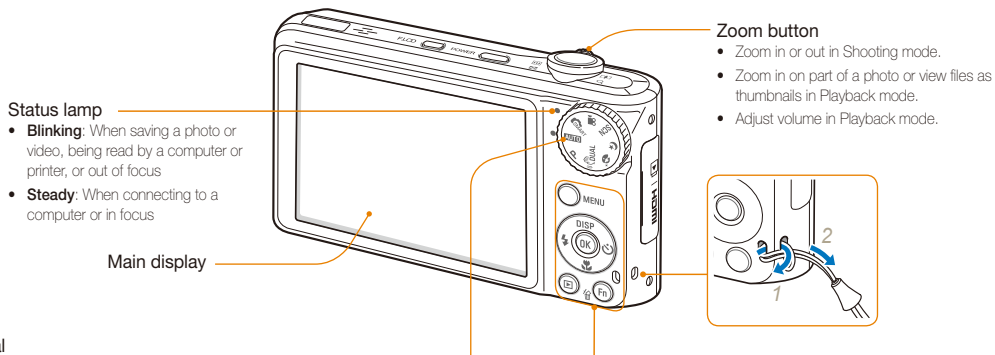

Mode dial

Icon	Mode	Description
	Smart Auto	Take a photo by letting the camera select a scene mode as it detects
	Auto	Take a photo quickly and easily with minimal settings
	Program	Take a photo by setting options
	DUAL IS	Take a photo with options suitable for reducing camera shake
	Beauty Shot	Take a photo of a person with options to hide facial imperfections
	Night	Take a photo with options for shooting at night
	Scene	Take a photo with options preset for a specific scene
	Movie	Record a video

Button	Description															
	MENU Access options or menus															
	Navigation <table border="1"> <tr> <td></td> <td>In Shooting mode</td> <td>While setting</td> </tr> <tr> <td></td> <td>Change the display option</td> <td>Move up</td> </tr> <tr> <td></td> <td>Change the macro option</td> <td>Move down</td> </tr> <tr> <td></td> <td>Change the flash option</td> <td>Move left</td> </tr> <tr> <td></td> <td>Change the timer option</td> <td>Move right</td> </tr> </table>		In Shooting mode	While setting		Change the display option	Move up		Change the macro option	Move down		Change the flash option	Move left		Change the timer option	Move right
	In Shooting mode	While setting														
	Change the display option	Move up														
	Change the macro option	Move down														
	Change the flash option	Move left														
	Change the timer option	Move right														
	OK Confirm the highlighted option or menu															
	Playback Enter Playback mode															
	Function <ul style="list-style-type: none"> • Access options in Shooting mode • Delete files in Playback mode 															

Inserting the battery and memory card

Learn to insert the battery and an optional microSD™ memory card into the camera.

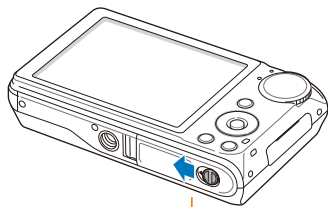

Insert a memory card with the gold-colored contacts facing up.

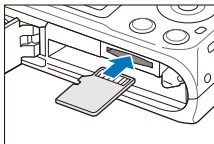

Insert the battery with the Samsung logo facing up.

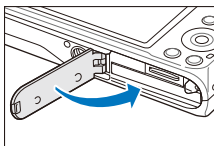
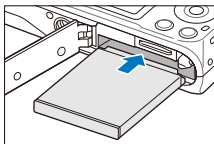

Removing the battery and memory card

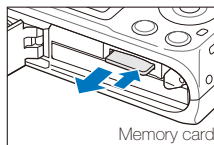

Push gently until the card disengages from the camera and then pull it out of the slot.

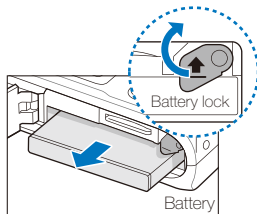

Push the lock up to release the battery.



The internal memory can be used as a temporary storage device when the memory card is not inserted.

Charging the battery and turning your camera on

Charging the battery

Before using the camera for the first time, you must charge the battery. Attach the USB cable to the AC adapter and then plug the end of cable with the indicator light into your camera.

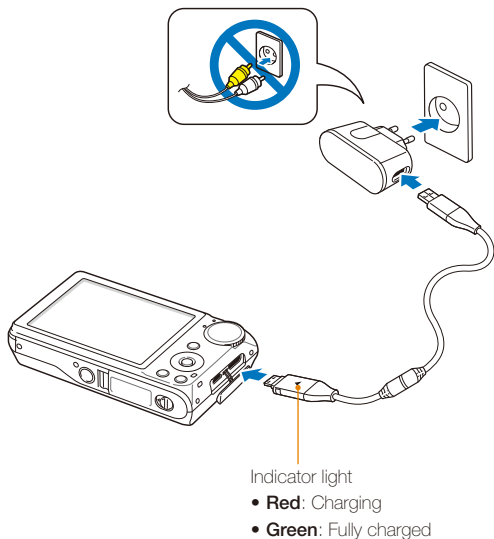

Turning on your camera

Press **[POWER]** to turn your camera on or off.

- The initial setup screen appears when you turn on the camera for the first time. (p. 17)

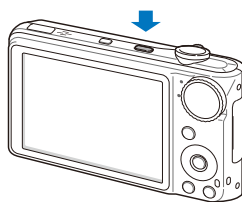

Turning on your camera in Playback mode

Press **[▶]**. The camera turns on and accesses Playback mode immediately.

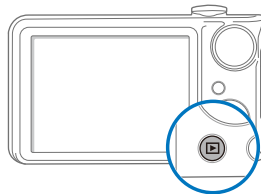

When you turn on your camera by pressing and holding **[▶]** for about 5 seconds, the camera does not emit any camera sounds.

Performing the initial setup

The initial setup screen appears to allow you to configure the camera's basic settings.

- 1 Press [POWER].
 - The initial setup screen appears when you turn on the camera for the first time.
- 2 Press [OK] to select **Language** and press [OK] or [OK].

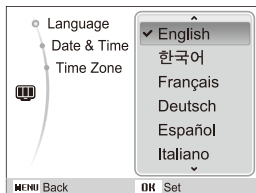

- 3 Press [DISP] or [OK] to select a language and press [OK].
- 4 Press [DISP] or [OK] to select **Time Zone** (Time Zone) and press [OK] or [OK].

- 5 Press [DISP] or [OK] to select a time zone and press [OK].
 - To set the daylight-saving time, press [DISP].

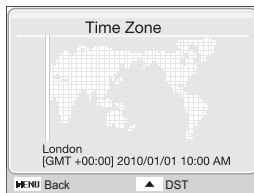

- 6 Press [DISP] or [OK] to select **Date & Time** (Date & Time) and press [OK] or [OK].
- 7 Press [DISP] or [OK] to select an item.

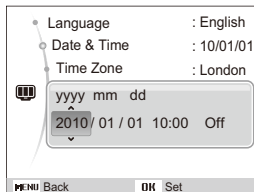

- 8 Press [DISP] or [OK] to set the date and time or select a date format, and press [OK].

Learning icons

The icons displayed will change according to the mode you select or the options you set.

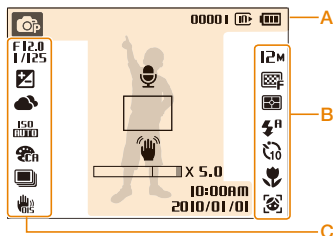

A. Information

Icon	Description
	Selected shooting mode
00001	Available number of photos
00:00:20	Available recording time
	Internal memory
	Memory card inserted
	<ul style="list-style-type: none"> : Fully charged : Partially charged (Red) : Charging needed
	Voice memo

Icon	Description
	Auto focus frame
	Camera shake
X 5.0	Zoom ratio
10:00 AM 2010/01/01	Current date and time

B. Icons on the right

Icon	Description
12M	Photo resolution
1280 1080	Video resolution
30 	Frame rate
	Photo quality
	Metering option
	Flash option
	Timer option
	Auto focus option
	Face detection
	Voice muted

C. Icons on the left



Icon	Description
F12.0 1/125	Aperture and shutter speed
LT	Long time shutter
	Exposure value
	White balance
	Face tone
	Face retouch
50 1600	ISO speed
	Photo style
	Smart filter effect
	Image adjustment (contrast, sharpness, saturation)
	Burst type
	Optical Image Stabilization (OIS)

Selecting options

You can select options by pressing **[MENU]** and using the navigation buttons (**[DISP]**, **[**], **[**], **[**]).



You can also access shooting options by pressing **[Fn]** but some options are not available.

- 1 In Shooting mode, press **[MENU]**.
- 2 Use the navigation buttons to scroll to an option or menu.
 - To move left or right, press **[**] or **[**].
 - To move up or down, press **[DISP]** or **[**].

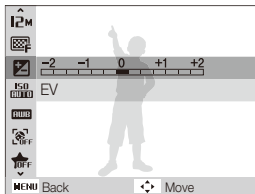

- 3 Press **[OK]** to confirm the highlighted option or menu.

Going back to the previous menu

Press **[MENU]** again to go back to the previous menu.



Press **[Shutter]** to return to Shooting mode.

E.g. Selecting a white balance option in the P mode

1 Rotate the mode dial to **P**.



2 Press **[MENU]**.

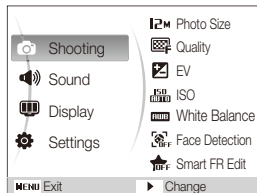

3 Press **[DISP]** or to scroll to **Shooting** and then press or **[OK]**.

4 Press **[DISP]** or to scroll to **White Balance** and then press or **[OK]**.

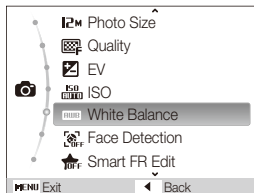

5 Press or to scroll to a white balance option.

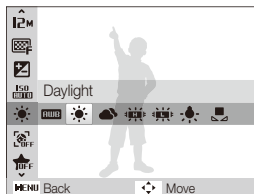

6 Press **[OK]**.

Setting the display and sound

Learn how to change the basic settings for the display and sound according to your preferences.

Changing the display type

Select a style of display for Shooting or Playback mode.

Press **[DISP]** repeatedly to change a display type.

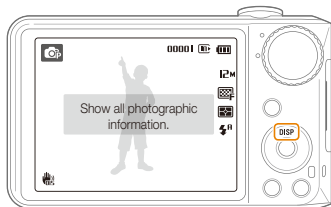

Mode	Description
Shooting	<ul style="list-style-type: none">• Display all information about shooting• Hide information about shooting, except the available number of photos (or available recording time) and the battery icon
Playback	<ul style="list-style-type: none">• Display all information about the current photo• Hide all information about the current file• Display information about the current file, except the shooting settings and captured date

Setting the sound

Set whether your camera emits a specified sound when you operate your camera.

- 1 In Shooting or Playback mode, press **[MENU]**.
- 2 Select **Sound** → **Beep Sound** → an option.

Option	Description
Off	The camera does not emit any sounds.
1/2/3	The camera emits sounds.

Taking photos

Learn basic actions to take photos easily and quickly in the Auto mode.

- 1 Rotate the mode dial to **AUTO**.



- 2 Align your subject in the frame.

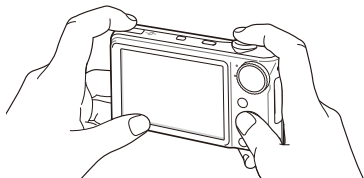

- 3 Half-press **[Shutter]** to focus.
 - A green frame means the subject in focus.

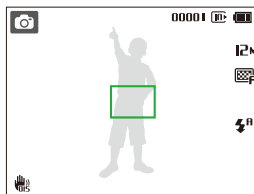

- 4 Press **[Shutter]** to take a photo.



See page 26 for tips to get clearer photos.

Turning on the front display

The front display will help you take self-portraits or photos of children. You can also use the Couple mode with the front display. (p. 37)

Press **[Front LCD]** to turn on the front display.

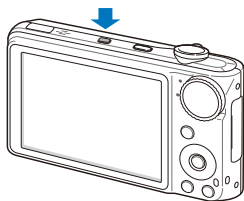

- When you set timer options, the front display will remain active. (p. 43)
- When you turn on the front display, the icons on the main display may not be shown and the main display may dim.
- When you use the camera in brightly lit or sunny areas, you may not be able to see the front display clearly.

Zooming

You can shoot close-up photos by adjusting the zoom. Your camera has a 5X optical zoom and 5X digital zoom. By using both, you can zoom in up to 25 times.

Rotate **[Zoom]** right to zoom in on your subject. Rotate **[Zoom]** left to zoom out.

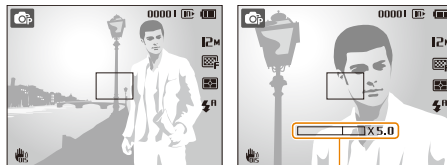

Zoom ratio

Zoom out



Zoom in

Digital zoom

If the zoom indicator is in the digital range, your camera is using the digital zoom. The picture quality may deteriorate when you use the digital zoom.

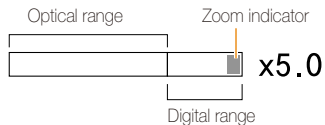

- The digital zoom is not available when using **SMART**, **DUAL**, **SCN** (in some scenes), **C**, and **AF** modes and when used with **Face Detection** and **Smart Filter**.
- It may take longer to save a photo when using the digital zoom.

Reducing camera shake (OIS) AUTO P

Reduce camera shake optically in Shooting mode.

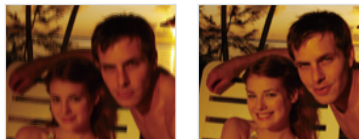

Before correction

After correction

- 1 In Shooting mode, press **[MENU]**.
- 2 Select **Shooting** → **OIS** → an option.

Option	Description
	Off: Deactivate the OIS function.
	On: Activate the OIS function.



- OIS may not function properly when:
 - you move your camera to follow a moving subject
 - you use digital zoom
 - there is too much camera shake
 - the shutter speed is slow (e.g., when in the  mode)
 - the battery is low
 - you take a close-up shot
- If you use the OIS function with a tripod, your images may be blurred by the vibration of the OIS sensor. Deactivate the OIS function when you use a tripod.
- If the camera is impacted, the display will be blurry. In this case, turn off the camera and turn it on again to use the OIS function correctly.
- In some scene modes, the OIS function is unavailable.

Tips for getting a clearer photo

Holding your camera correctly

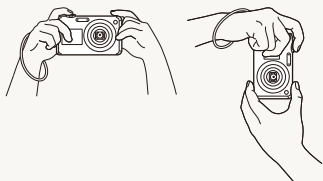

Make sure nothing is blocking the lens.

Half-pressing the shutter button

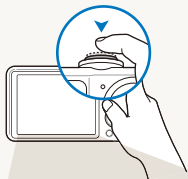

Half-press **[Shutter]** and adjust the focus. Focus and exposure will be adjusted automatically.

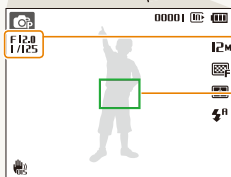

The aperture value and shutter speed are automatically set.

Focus frame

- Press **[Shutter]** to take the photo if displayed in green.
- Change the frame and half-press **[Shutter]** again if displayed in red.

Reducing camera shake



- Set the Optical Image Stabilization option to reduce camera shake optically. (p. 24)
- Select the **DUAL** mode to reduce camera shake both optically and digitally. (p. 33)

When is displayed

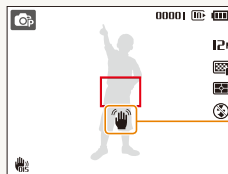

Camera shake

When shooting in the dark, avoid setting the flash option to **Slow Sync** or **Off**. The aperture remains open longer and it may be harder to hold the camera still.

- Use a tripod or set the flash option to **Fill in**. (p. 45)
- Set ISO speed options. (p. 46)

Preventing your subject from being out of focus

It may be difficult to get your subject in focus when:

- there is little contrast between the subject and background
(When your subject is wearing a color of clothing that is similar to the background)
- the light source behind the subject is too bright
- the subject is shiny
- the subject includes horizontal patterns, such as blinds
- the subject is not positioned in the center of the frame



Use the focus lock

Half-press **[Shutter]** to focus. When the subject is in focus, you can reposition the frame to change the composition.

When you are ready, press **[Shutter]** to take your photo.

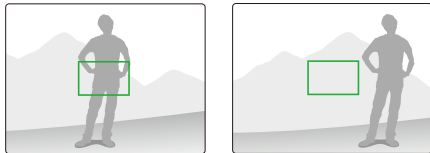

- When you take photos in low light



Turn on the flash.
(p. 45)

- When subjects are moving fast

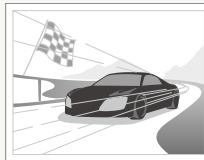

Use the continuous
or motion capture
function. (p. 57)

Extended functions

Learn how to take a photo by selecting a mode and how to record a video or voice memo.

Shooting modes	29
Using the Smart Auto mode	29
Using the Scene mode	30
Using the frame guide	31
Using the Night mode	31
Using the Beauty Shot mode	32
Using the DUAL IS mode	33
Using the Program mode	34
Recording a video	34
Using the Smart Scene Detection mode	36
Taking photos with the front display	37
Using the Self-portrait mode	37
Using the Couple mode	38
Using the Children mode	38
Recording a video with the front display	39
Recording voice memos	40
Recording a voice memo	40
Adding a voice memo to a photo	40

Shooting modes

Take photos or record videos by selecting the best shooting mode for the conditions.

Using the Smart Auto mode



In this mode, your camera automatically chooses the appropriate camera settings based on a detected type of scene. It will be helpful if you are not familiar with the camera settings for various scenes.

1 Rotate the mode dial to .

2 Align your subject in the frame.

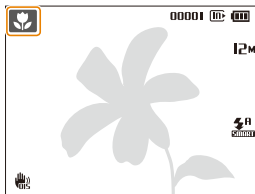
- The camera selects a scene automatically. An appropriate mode icon will appear at the top left of the screen.





Icon	Description
	Appears when taking photos of landscapes.
	Appears when taking photos of bright white backgrounds.
	Appears when taking photos of landscapes at night. This is available only when the flash is off.

Icon	Description
	Appears when taking portraits at night.
	Appears when taking photos of landscapes with backlighting.
	Appears when taking portraits with backlighting.
	Appears when taking portraits.
	Appears when taking close-up photos of objects.
	Appears when taking close-up photos of text.
	Appears when taking photos of sunsets.
	Appears when taking photos of clear skies.
	Appears when taking photos of forested areas.
	Appears when taking close-up photos of colorful subjects.
	Appears when taking close-up portraits of people.
	Appears when the camera and subject are stable for a while. This is available only when you are shooting in the dark.
	Appears when taking photos of actively moving subjects.
	Appears when taking photos of fireworks. This is available only when you use a tripod.

3 Half-press [**Shutter**] to focus.

4 Press [**Shutter**] to take the photo.



- If the camera does not recognize a proper scene mode,  will appear and the default settings will be used.
- Even if there is a face detected, the camera may not select a portrait mode depending on the subject's position or lighting.
- The camera may not select the correct scene depending on shooting environments, such as camera shake, lighting, and distance to the subject.
- Even if you use a tripod, the  mode may not be detected depending on the subject's movement.

Using the Scene mode

Take a photo with options preset for a specific scene.

1 Rotate the mode dial to **SCN**.

2 Select a scene.

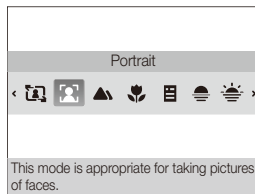

- To change the scene mode, press [**MENU**] and select **Scene** → a scene.
- For the Frame Guide mode, see "Using the frame guide" on page 31.
- For the Night mode, see "Using the Night mode" on page 31.

3 Align your subject in the frame and half-press [**Shutter**] to focus.

4 Press [**Shutter**] to take the photo.

Using the frame guide

When you want another person to take a photo of you, you can compose the scene with the frame guide feature. The frame guide will help the other person take a photo of you by showing the part of the pre-composed scene.

- 1 Rotate the mode dial to **SCN**.
- 2 Select **Frame Guide**.
- 3 Align your subject in the frame and press **[Shutter]**.
 - Transparent guides will appear on the left and right of the frame.

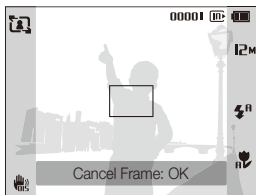

- 4 Ask another person to take a photo.
 - The person must align the subject in the frame by using the guides, and then press **[Shutter]** to take the photo.
- 5 To cancel the guides, press **[OK]**.

Using the Night mode

Use the Night mode to take a photo with options for shooting at night. Use a tripod to prevent your camera from shaking.

- 1 Rotate the mode dial to **☾**.
- 2 Align your subject in the frame and half-press **[Shutter]** to focus.
- 3 Press **[Shutter]** to take the photo.

Adjusting the exposure in the Night mode

In the Night mode, you can catch brief flashes of light as curved streaks by extending the exposure. Use a slow shutter speed to extend the time until the shutter closes. Increase the aperture value to prevent overexposure.

- 1 Rotate the mode dial to **☾**.
- 2 Press **[MENU]**.
- 3 Select **Shooting** → **Long Time Shutter**.

- 4 Select the aperture value or shutter speed.

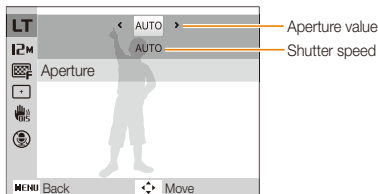

- 5 Select an option.
 - If you select **AUTO**, the aperture value or shutter speed will be adjusted automatically.
- 6 Align your subject in the frame and half-press [**Shutter**] to focus.
- 7 Press [**Shutter**] to take the photo.



Use a tripod to prevent your photos from blurring.

Using the Beauty Shot mode

Take a photo of a person with options to hide facial imperfections.

- 1 Rotate the mode dial to .
- 2 To make the subject's skin tone appear lighter (face only), press [**MENU**].
- 3 Select **Shooting** → **Face Tone** → an option.
 - Select a higher setting to make skin tone appear lighter.

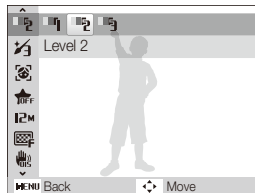

- 4 To hide facial imperfections, press [**MENU**].

- 5 Select **Shooting** → **Face Retouch** → an option.
- Select a higher setting to hide a greater number of imperfections.

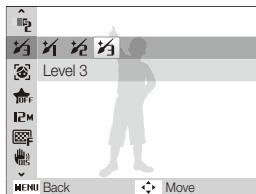

- 6 Align your subject in the frame and half-press [**Shutter**] to focus.
- 7 Press [**Shutter**] to take the photo.

 The focus distance will be set to **Auto Macro**.

Using the DUAL IS mode

Reduce camera shake and prevent blurred photos with Optical and Digital Image Stabilization functions.

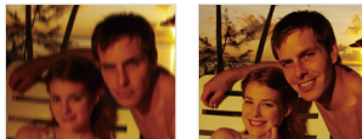

Before correction

After correction

- 1 Rotate the mode dial to .
- 2 Align your subject in the frame and half-press [**Shutter**] to focus.
- 3 Press [**Shutter**] to take the photo.

-  The digital zoom will not work in this mode.
- The photo will be corrected optically only when taken with a light source that is brighter than fluorescent light.
- If your subject is moving rapidly, the photo may be blurry.
- Set the Optical Image Stabilization option to reduce camera shake in different shooting modes. (p. 24)

Using the Program mode

Set various options (except for shutter speed and aperture value) in the Program mode.

- 1 Rotate the mode dial to **P**.
- 2 Set options.
(For a list of options, refer to "Shooting options.")
- 3 Align your subject in the frame and half-press [**Shutter**] to focus.
- 4 Press [**Shutter**] to take the photo.

Recording a video

Record videos of up to 20 minutes in length in high definition. The recorded video is saved as an H.264 (MPEG-4.AVC) file.





- H.264 (MPEG-4 part10/AVC) is a high-compression video format established by international standard organizations ISO/IEC and ITU-T.
- Some memory cards may not support high definition recording. In this case, set a lower resolution. (p. 42)
- When the Optical Image Stabilization is activated, your video may be recorded with the OIS operation sound.

- 1 Rotate the mode dial to **MOV**.
- 2 Press [**MENU**].
- 3 Select **Movie** → **Frame Rate** → a frame rate (the number of frames per second).
 - As the number of frames increases, action appears more natural, but the file size is increased.



60 FPS is available only when the video resolution is 320 x 240.

- 4 Press **[MENU]**.
- 5 Select **Movie** → **Voice** → a sound option.

Option	Description
	On: Record a video with sound. (While you are zooming, sound recording will be interrupted.)
	Off: Record a video without sound.

- 6 Set other options as desired.
(For options, refer to “Shooting options.”)
- 7 Press **[Shutter]** to start recording.
- 8 Press **[Shutter]** again to stop recording.

To pause recording

The camera allows you to pause temporarily while recording a video. With this function, you can record your favorite scenes as a single video.

Press **[OK]** to pause while recording. Press it again to resume.

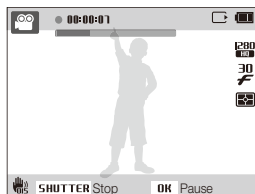

Using the Smart Scene Detection mode

In this mode, your camera automatically chooses the appropriate camera settings based on a detected type of scene.

- 1 Rotate the mode dial to .
- 2 Press **[MENU]**.
- 3 Select **Movie** → **Smart Scene Detection** → **On**.
- 4 Align your subject in the frame.
 - The camera selects a scene automatically. An appropriate mode icon will appear at the top left of the screen.



Icon	Description
	Appears when recording videos of landscapes.
	Appears when recording videos of clear skies.
	Appears when recording videos of forested areas.
	Appears when recording videos of sunsets.

5 Press **[Shutter]** to start recording.

6 Press **[Shutter]** again to stop recording.



- If the camera does not recognize a proper scene mode,  will not change and the default settings will be used.
- The camera may not select the correct scene depending on shooting environments, such as camera shake, lighting and distance to the subject.

Taking photos with the front display

The front display will help take self-portraits or photos of children. You can also use the Couple mode with the front display.



- When you press **[Front LCD]** repeatedly, the shooting mode changes from Self-portrait mode to Couple mode or to Children mode. When recording videos, you cannot use the Couple mode.
- In some shooting modes, the front display does not display a frame to indicate the detected face and the Self-portrait mode and the Couple mode are not available.

Using the Self-portrait mode

Take photos of yourself conveniently using the front display.



You can set the camera to automatically release the shutter when it detects a smiling face while taking a photo with the front display. (p. 89)

1 In Shooting mode, press **[Front LCD]** once.

- Your camera will detect your face automatically and display a frame to indicate the detected face.

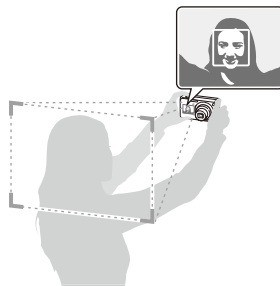

2 Half-press **[Shutter]** to focus.

3 Press **[Shutter]** to take the photo.

Using the Couple mode

This mode detects two subjects leaning in toward each other and automatically captures images of posing couples.

- 1 In Shooting mode, press **[Front LCD]** twice.

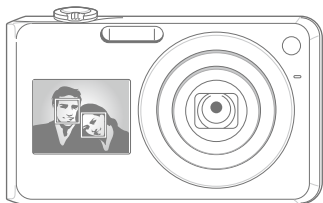

- The white frame means that the faces are recognized.
- The green frame means that the faces are in focus when you half-press **[Shutter]**.

- 2 Lean in toward each other in the frame.



- The camera will detect two faces of the subjects at the same distance from the camera.
- The camera may not detect the composition depending on the pose of couples.

Using the Children mode

In this mode, you can draw children's attention to the camera by showing a short animation on the front display.

- 1 In Shooting mode, press **[Front LCD]** three times.
 - An animation will play.

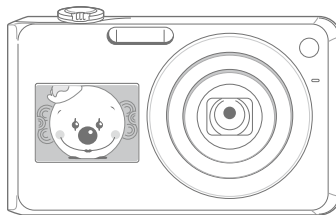

- 2 Align your subject in the frame and half-press **[Shutter]**.
- 3 Press **[Shutter]** to take the photo.



- You can download animations from the website. Visit www.samsung.com or www.samsungimaging.com for more information.
- You can add sounds to animations to draw children's attention. (p. 86)
- You can set the camera to automatically release the shutter when it detects a smiling face while using the Children mode. (p. 89)

Recording a video with the front display

Recording a video in the Self-portrait mode

- 1 Rotate the mode dial to .
- 2 Press [**Front LCD**] once.
- 3 Press [**Shutter**] to start recording.
- 4 Press [**Shutter**] again to stop recording.

Recording a video in the Children mode

- 1 Rotate the mode dial to .
- 2 Press [**Front LCD**] twice.
- 3 Press [**Shutter**] to start recording.
- 4 Press [**Shutter**] again to stop recording.

Recording voice memos

AUTO P DUAL Q SCN

Learn how to record a voice memo that you can play back at any time. You can add a voice memo to a photo as a short reminder of shooting conditions.



You will get the best sound quality when recording 40 cm away from the camera.

Recording a voice memo

- 1 In Shooting mode, press **[MENU]**.
- 2 Select **Shooting** → **Voice** → **Record**.
- 3 Press **[Shutter]** to record.
 - You can record voice memos of up to 10 hours in length.
 - Press **[OK]** to pause or resume recording.



- 4 Press **[Shutter]** to stop.
 - Press **[Shutter]** again to record a new voice memo.
- 5 Press **[MENU]** to switch to Shooting mode.

Adding a voice memo to a photo

- 1 In Shooting mode, press **[MENU]**.
- 2 Select **Shooting** → **Voice** → **Memo**.
- 3 Align your subject in the frame and take a photo.
 - You will begin recording a voice memo right after taking the photo.
- 4 Record a short voice memo (10 seconds maximum).
 - Press **[Shutter]** to stop recording a voice memo.

Shooting options

Learn about the options you can set in shooting mode.

Selecting a resolution and quality	42	Adjusting brightness and color	54
Selecting a resolution	42	Adjusting the exposure manually (EV)	54
Selecting image quality	42	Compensating for backlighting (ACB)	54
Using the timer	43	Changing the metering option	55
Shooting in the dark	45	Selecting a light source (White balance)	55
Preventing red-eye	45	Using burst modes	57
Using the flash	45	Improving your photos	58
Adjusting the ISO speed	46	Applying photo styles	58
Changing the camera's focus	47	Applying smart filter effects	59
Using macro	47	Adjusting your photos	60
Using auto focus	47		
Using tracking auto focus	48		
Adjusting the focus area	49		
Using face detection	50		
Detecting faces	50		
Taking a smile shot	51		
Detecting eye blinking	51		
Using smart face recognition	52		
Registering faces as your favorites (My Star) ...	53		

Selecting a resolution and quality





Learn how to change the image resolution and quality settings.

Selecting a resolution

As you increase the resolution, your photo or video will include more pixels, so it can be printed on larger paper or displayed on a larger screen. When you use a high resolution, the file size will also increase.

When taking a photo:

- 1 In Shooting mode, press **[MENU]**.
- 2 Select **Shooting** → **Photo Size** → an option.

Option	Description
	4000 X 3000: Print on A1 paper.
	3984 X 2656: Print on A2 paper in wide ratio (3:2).
	3840 X 2160: Print on A2 paper in panorama ratio (16:9) or play back on an HDTV.
8M	3264 X 2448: Print on A3 paper.
5M	2560 X 1920: Print on A4 paper.
3M	2048 X 1536: Print on A5 paper.
	1920 X 1080: Print on A5 paper in panorama ratio (16:9) or play back on an HDTV.
1M	1024 X 768: Attach to email.

When recording a video:



- 1 In the  mode, press **[MENU]**.
- 2 Select **Movie** → **Movie Size** → an option.

Option	Description
	1280 X 720 HQ: Play back high-quality files on an HDTV.
1280	1280 X 720: Play back on an HDTV.
640	640 X 480: Play back on a general TV.
320	320 X 240: Post on a web page.

Selecting image quality

Photos you take are compressed and saved in JPEG format. Higher quality images will result in larger sizes.

- 1 In Shooting mode, press **[MENU]**.
- 2 Select **Shooting** → **Quality** → an option.

Option	Description
	Super Fine
	Fine
	Normal

The options may differ depending on the shooting mode.

Using the timer

AUTO P DUAL [i] SCN [i] SMART

Learn how to set the timer to delay shooting.

1 In Shooting mode, press [⏻].

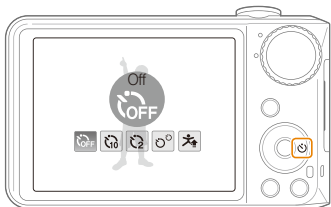

2 Select an option.

Option	Description
[OFF]	Off: The timer is not active.
[10]	10 Sec: Take a photo in 10 seconds.
[2]	2 Sec: Take a photo in 2 seconds.
[Double]	Double: Take a photo in 10 seconds and take another in 2 seconds.
[Jump Shot]	Jump Shot: Activate the jump shot timer. (p. 44)

The options may differ depending on the shooting mode.

3 Press [Shutter] to start the timer.

- The AF-assist light/timer lamp blinks. The camera will automatically take a photo at the specified time.
- The front display will start the countdown a few seconds before shooting.

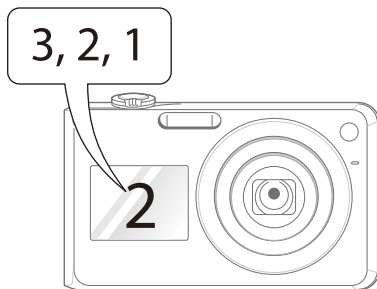

- Press [⏻] to cancel the timer.
- Depending on the selected face detection option, the timer is not available or some timer options are not available.

Using the jump shot timer

Take a photo of people jumping. The jump shot timer tells you when to jump by displaying an icon on the front display.



- 1 In Shooting mode, press [📷].
- 2 Select **Jump Shot**.
 - The front display will turn on.
- 3 Press [Shutter].
 - The front display will start the countdown a few seconds before shooting.

- 4 Jump when the jump icon appears on the front display.

- The camera will take 3 photos in succession.

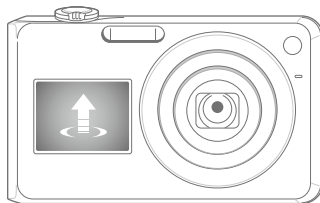

If you are taking photos using the jump shot timer in low light conditions or indoors, photos may be dark.

Shooting in the dark

Learn how to take photos at night or in low light conditions.

Preventing red-eye

If the flash fires when you take a photo of a person in the dark, a red glow may appear in the eyes. To prevent this, select **Red-eye** or **Red-eye Fix**. Refer to flash options in "Using the flash."







Using the flash

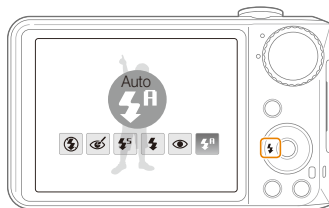



Use the flash when taking photos in the dark or when you need more light on your photos.

1 In Shooting mode, press .



2 Select an option.

Option	Description
	Off: <ul style="list-style-type: none">The flash will not fire.Camera shake warning () will be displayed when shooting in low light.
	Auto: The camera will select a proper flash setting for the detected scene in the  mode.

Option	Description
	<p>Red-eye Fix*:</p> <ul style="list-style-type: none"> The flash fires when the subject or background is dark. The camera corrects red-eyes through its advanced software analysis.
	<p>Slow Sync:</p> <ul style="list-style-type: none"> The flash fires and the shutter stays open longer. Select this when you want to capture ambient light to reveal more details in the background. Use a tripod to prevent your photos from blurring.
	<p>Fill in:</p> <ul style="list-style-type: none"> The flash always fires. Light intensity is adjusted automatically.
	<p>Red-eye*:</p> <ul style="list-style-type: none"> The flash fires when the subject or background is dark. The camera reduces red-eyes.
	<p>Auto: The flash fires automatically when the subject or background is dark.</p>

The options may differ depending on the shooting mode.

* There is an interval between two bursts of the flash. Do not move until the flash fires a second time.



- Flash options are not available if you set burst options or select **Blink Detection**.
- Make sure that your subjects are within the recommended distance from the flash. (p. 99)
- If there is reflected light or much dust in the air, tiny spots may appear on your photo.

Adjusting the ISO speed P

The ISO speed is the measure of a film's sensitivity to light as defined by the International Organization for Standardization (ISO). The higher ISO speed you select, the more sensitive to light your camera becomes. With a higher ISO speed, you can get a better photo without using the flash.

1 In Shooting mode, press **[MENU]**.

2 Select **Shooting** → **ISO** → an option.

- Select  to use an appropriate ISO speed based on the brightness of the subject and lighting.



- The higher ISO speed you select, the more image noise you may get.
- When **Motion Capture** is set, ISO speed will be set to **Auto**.

Changing the camera's focus

Learn how to adjust the camera's focus according to your subjects.

Using macro

Use macro to take close-up photos of subjects, such as flowers or insects. Refer to macro options in "Using auto focus."



- Try to hold the camera very still to prevent blurry photos.
- Turn off the flash if the distance to the subject is less than 40 cm.



Using auto focus

To take sharp photos, select the appropriate focus according to your distance from the subject.

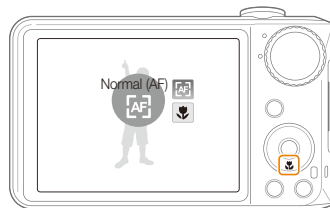
1 In Shooting mode, press .



2 Select an option.

Option	Description
	Normal (AF): Focus on a subject farther than 80 cm (farther than 1 m when using zoom).
	Macro: Focus on a subject 5-80 cm (1-1.5 m when using zoom).
	Auto Macro: Focus on a subject farther than 5 cm (farther than 1 m when using zoom).

The options may differ depending on the shooting mode.

Using tracking auto focus AUTO P DUAL SCN

Tracking AF allows you to track and auto focus on your subject, even when you are moving.

- 1 In Shooting mode, press **[MENU]**.
- 2 Select **Shooting** → **Focus Area** → **Tracking AF**.
- 3 Focus on the subject you want to track and press **[OK]**.
 - A focus frame will appear on the subject and will follow the subject as you move the camera.

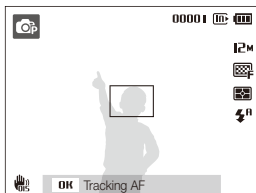

- The white frame means that your camera is tracking the subject.
- The green frame means that your subject is in focus when you half-press **[Shutter]**.





- Tracking a subject may fail when:
 - the subject is too small or the subject moves excessively
 - the subject is backlit or you are shooting in a dark place
 - colors or patterns on the subject and the background are the same
 - the camera shakes excessivelyIn these cases, the focus frame will appear as a white single-line frame.
- If the camera fails to track the subject, you must reselect the subject to track.
- If the camera fails to fix the focus, the focus frame will change to a red single-line frame.
- If you use this function, you cannot set face detection, photo style options, and smart filter effects.

Adjusting the focus area

You can get clearer photos by selecting an appropriate focus area according to your subject's location in the scene.

- 1 In Shooting mode, press **[MENU]**.
- 2 Select **Shooting** → **Focus Area** → an option.

Option	Description
	Center AF: Focus on the center (suitable when subjects are located in the center).
	Multi AF: Focus on one or more of 9 possible areas.
	Tracking AF: Focus on and track the subject. (p. 48)

The options may differ depending on the shooting mode.

Using face detection

AUTO P QUAL SCN

If you use face detection options, your camera can automatically detect a human face. When you focus on a human face, the camera adjusts the exposure automatically. Take photos quickly and easily by using **Blink Detection** to detect closed eyes or **Smile Shot** to capture a smiling face. You can also use **Smart Face Recognition** to register faces and prioritize the focus on them.



- In some scene modes, face detection is unavailable.
- Face detection may not be effective when:
 - the subject is far from the camera (The focus frame will appear orange for **Smile Shot** and **Blink Detection**)
 - it is too bright or too dark
 - the subject is not facing the camera
 - the subject is wearing sunglasses or a mask
 - the subject is in backlighting or the lighting condition is unstable
 - the subject's facial expression changes remarkably
- Face detection is not available when using a photo style, smart filter effect, or image adjustment option or when used with **Tracking AF**.
- Face detection is not available when using the digital zoom.
- Depending on the selected face detection option, the timer is not available or some timer options are not available.
- Depending on the selected face detection option, some burst options are not available.
- When you take photos of detected faces, they will be registered in the face list.
- You can view registered faces in order of priority in Playback mode. (p. 63) Even though faces are registered successfully, they may not be classified in Playback mode.
- The detected face in Shooting mode may not appear in the face list or Smart Album.

Detecting faces

Your camera automatically detects human faces (up to 10 human faces).

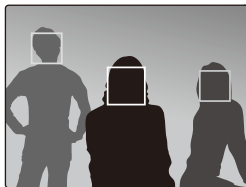

- 1 In Shooting mode, press **[MENU]**.
- 2 Select **Shooting** → **Face Detection** → **Normal**.
 - The nearest face appears in a white focus frame and the rest of the faces appear in gray focus frames.



- The closer you are to the subject, the quicker your camera will detect faces.
- When you use the burst option, the detected faces may not be recognized.

Taking a smile shot

The camera automatically releases the shutter when it detects a smiling face.



- 1 In Shooting mode, press **[MENU]**.
- 2 Select **Shooting** → **Face Detection** → **Smile Shot**.
 - When your subject smiles broadly, your camera can detect the smile more easily.

Detecting eye blinking

If your camera detects closed eyes, it will automatically take 2 photos in succession.



- 1 In Shooting mode, press **[MENU]**.
- 2 Select **Shooting** → **Face Detection** → **Blink Detection**.



- Hold your camera still while **"Capturing"** is displayed on the screen.
- When blink detection fails, **"Picture taken with eyes closed."** message appears. Take another photo.

Using smart face recognition

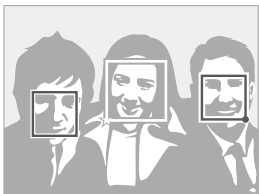

The camera automatically registers faces that you frequently photograph (up to 10 people). This feature will automatically prioritize the focus on those faces. This feature is available only when you use a memory card.



- The camera may recognize and register faces incorrectly depending on lighting conditions, remarkable changes in the subject's pose or face, and whether or not the subject is wearing glasses.
- The camera can automatically register up to 12 faces. If the camera recognizes a new face when there are 12 registered faces, it will replace the face in the lowest priority with the new one.
- The camera can detect up to 10 faces in one scene.

1 In Shooting mode, press **[MENU]**.

2 Select **Shooting** → **Face Detection** → **Smart Face Recognition**.

- The nearest face appears in a white focus frame and the rest of the faces appear in gray focus frames.
-  : Indicate favorite faces (To register favorite faces, see page 53).
-  : Indicate faces that the camera automatically registers.

Registering faces as your favorites (My Star)

You can register your favorite faces to prioritize the focus and exposure on those faces. This feature is available only when you use a memory card.

- 1 In Shooting mode, press **[MENU]**.
- 2 Select **Shooting** → **Smart FR Edit** → **My Star**.
- 3 Align your subject's face with the oval guideline and press **[Shutter]** to register the face.
 - If the subject's face is not aligned with the oval guideline, the white frame will not appear.
 - You can take photos of a subject's face directly from the front, to the left side, to the right side, from above, or from below.
 - Take photos of one person at a time when registering faces.

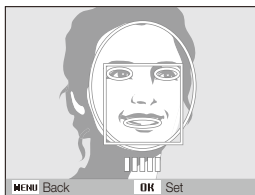

- 4 When you are finished taking the photos, the face list appears.

- Your favorite faces are indicated with a ★ on the face list.



- You can register up to 8 favorite faces.
- The flash option will be set to **Off**.
- If you register the same face twice, you can delete one of the faces in the face list.

Viewing your favorite faces

- 1 In Shooting mode, press **[MENU]**.
- 2 Select **Shooting** → **Smart FR Edit** → **Face List**.



- To change the ranking of the favorite faces, press **[Fn]** and select **Edit Ranking**. (p. 63)
- To cancel the favorite faces, press **[Fn]** and select **Delete My Star**. (p. 63)

Adjusting brightness and color

Learn how to adjust the brightness and color for better image quality.

Adjusting the exposure manually

(EV) P  

Depending on the intensity of the ambient light, your photos may be too bright or dark. In these cases, you can adjust the exposure to get a better photo.



Darker (-)



Neutral (0)



Brighter (+)

- 1 In Shooting mode, press **[MENU]**.
- 2 Select **Shooting** → **EV**.
- 3 Select a value to adjust the exposure.



- Once you adjust the exposure, the setting will remain the same. You may need to change the exposure value later to avoid overexposure or underexposure.
- If you cannot decide on an appropriate exposure, select **AEB** (Auto Exposure Bracket). The camera takes photos with different exposures: normal, underexposed, and overexposed. (p. 57)

Compensating for backlighting (ACB) P

When the light source is behind your subject or there is high contrast between your subject and the background, your subject is likely to appear dark in the photo. In this case, set the Auto Contrast Balance (ACB) option.



Without ACB



With ACB

- 1 In Shooting mode, press **[MENU]**.
- 2 Select **Shooting** → **ACB** → an option.

Option	Description
 Off	Off: ACB is off.
 On	On: ACB is on.





- The ACB feature is always on in the **AUTO** mode.
- You cannot set burst options when this feature is on.

Changing the metering option

The metering mode refers to the way in which a camera measures the quantity of light. The brightness and lighting of your photos will vary depending on the metering mode you select.

- 1 In Shooting mode, press **[MENU]**.
- 2 Select **Shooting** → **Metering** → an option.

Option	Description
	<p>Multi:</p> <ul style="list-style-type: none"> Your camera divides the scene into several areas, and then measures the light intensity of each area. Suitable for general photos.
	<p>Spot:</p> <ul style="list-style-type: none"> Your camera measures only the light intensity of the very center of the frame. If a subject is not in the center of the scene, your photo may be improperly exposed. Suitable for a subject with backlighting.
	<p>Center-weighted:</p> <ul style="list-style-type: none"> Your camera averages the meter reading of the entire frame with emphasis placed on the center. Suitable for photos with subjects in the center of the frame.

Selecting a light source (White balance)

The color of your photo depends on the type and quality of the light source. If you want the color of your photo to be realistic, select an appropriate lighting condition to calibrate the white balance, such as Auto WB, Daylight, Cloudy, or Tungsten.



 (Auto WB)



 (Daylight)









 (Cloudy)



 (Tungsten)

- 1 In Shooting mode, press **[MENU]**.
- 2 Select **Shooting** → **White Balance** → an option.

Icon	Description
	Auto WB: Use automatic settings depending on the lighting conditions.
	Daylight: Select when taking outdoor photos on a sunny day.
	Cloudy: Select when taking outdoor photos on a cloudy day or in shadows.
	Fluorescent_H: Select when shooting under a daylight fluorescent or three-way fluorescent light.
	Fluorescent_L: Select when shooting under white fluorescent light.
	Tungsten: Select when taking indoor photos under incandescent bulbs or halogen lamps.
	Measure: Shutter (Custom setting): Use your pre-defined settings.

Defining your own white balance

- 1 In Shooting mode, press **[MENU]**.
- 2 Select **Shooting** → **White Balance** → **Measure: Shutter**.
- 3 Aim the lens at a piece of white paper.

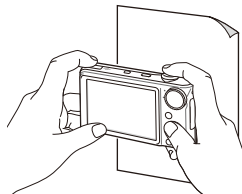



- 4 Press **[Shutter]**.

Using burst modes P

It can be difficult to take photos of fast-moving subjects or capture natural facial expressions and gestures of your subjects in photos. In these cases, select one of the burst modes.



- 1 In Shooting mode, press **[MENU]**.
- 2 Select **Shooting** → **Drive** → an option.

Option	Description
	Single: Take a single photo.
	Continuous: <ul style="list-style-type: none">• While you are pressing [Shutter], the camera takes photos continuously.• The maximum number of photos depends on the capacity of your memory card.
	Motion Capture: <ul style="list-style-type: none">• While you are pressing [Shutter], the camera takes VGA photos (6 photos per second; maximum of 30 photos).• The camera automatically shows you the photos just taken and then saves them.

Option	Description
	AEB: <ul style="list-style-type: none">• Take 3 photos with different exposures: normal, underexposed, and overexposed.• Use a tripod to prevent blurry photos.

The options may differ depending on the shooting mode.



- You can use the flash, timer, and ACB only when you select **Single**.
- When you select **Motion Capture**, the resolution will be set to VGA and the ISO speed will be set to **Auto**.
- Depending on the selected face detection option, some burst options are not available.

Improving your photos

Learn how to improve your photos by applying photo styles, colors, or smart filter effects, or make some adjustments.

Applying photo styles AUTO P DUAL

Apply a different photo style to your photos, such as Soft, Vivid, or Forest.



Soft



Vivid



Forest

- 1 In Shooting mode, press **[MENU]**.
- 2 Select **Shooting** → **Photo Style Selector** → an option.
 - Select **Custom RGB** to define your own RGB tone.



- When you select **Sketch**, the photo will be automatically resized to **5M** or smaller.
- If you use this function, you cannot set the smart filter and image adjustment options.

Defining your own RGB tone

- 1 In Shooting mode, press **[MENU]**.
- 2 Select **Shooting** → **Photo Style Selector** → **Custom RGB**.
- 3 Select a color (R: Red, G: Green, B: Blue).

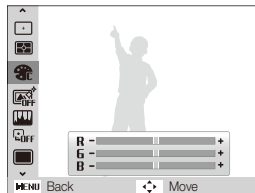

- 4 Adjust the amount of the selected color.
(-: less or +: more)

Applying smart filter effects AUTO P 4K DUAL 6K

Apply various filter effects to your photos to create unique images.



Miniature



Vignetting







Fish-eye 1



Fish-eye 2

- 1 In Shooting mode, press **[MENU]**.
- 2 Select **Shooting** → **Smart Filter**.
- 3 Select an effect.

Option	Description
	Normal: No effect.
	Miniature: Make a photo of a life-size location or object look like a photo of a miniature scale model. Blurring parts of the photo makes the scene seem much smaller than it actually is.
	Vignetting: Apply the retro-looking colors, high contrast, and strong vignette effect.
	Fish-eye 1: Distort close objects to imitate the visual effect of a fisheye lens.
	Fish-eye 2: Blacken the edges of the frame and distort objects to imitate the visual effect of a fisheye lens.



- If you select **Miniature** when recording a video, the miniature recording time is displayed with the  icon and is shorter than the real recording time.
- If you select **Miniature** when recording a video, the sound will not be recorded.
- When you apply a smart filter effect while recording a video, the video will be automatically resized to **640** or smaller.
- If you use this function, you cannot set the photo style and image adjustment options.

Adjusting your photos P

Adjust the contrast, sharpness, and saturation of your photos.

- 1 In Shooting mode, press **[MENU]**.
- 2 Select **Shooting** → **Image Adjust**.
- 3 Select an adjustment option.
 - Contrast
 - Sharpness
 - Saturation
- 4 Select a value to adjust the selected item.

Contrast option	Description
-	Decrease the color and brightness.
+	Increase the color and brightness.

Sharpness option	Description
-	Soften the edges on your photos (suitable for editing the photos on your computer).
+	Sharpen the edges to improve the clarity of your photos. This may also increase the noise on your photos.

Saturation option	Description
-	Decrease the saturation.
+	Increase the saturation.



- Select **0** if you do not want to apply any effects. (suitable for printing)
- If you use this function, you cannot set the photo style and smart filter effects.

Playback/Editing

Learn how to play back photos, videos, or voice memos and edit photos or videos. Also, learn how to connect your camera to your computer, photo printer, TV, or HDTV.

Playing back	62	Transferring files to your computer	
Starting Playback mode	62	(for Windows)	77
Viewing photos	66	Transferring files using Intelli-studio	78
Playing a video	68	Transferring files by connecting the camera	
Playing voice memos	69	as a removable disk	80
Editing a photo	70	Disconnecting the camera (for Windows XP)	81
Resizing photos	70	Transferring files to your computer	
Rotating a photo	70	(for Mac)	82
Applying photo styles	71	Printing photos with a photo printer	
Applying smart filter effects	72	(PictBridge)	83
Correcting exposure problems	73		
Creating a print order (DPOF)	74		
Viewing files on a TV or HDTV	75		

Playing back

Learn actions to play back photos, videos, or voice memos, and managing files.

Starting Playback mode

View photos or play videos and voice memos stored in your camera.

- 1 Press [▶].
 - The most recent file you have taken or recorded will be displayed.
 - If the camera is off, it will turn on.
- 2 Press [⚡] or [⏪] to scroll through files.
 - Press and hold to scroll through files quickly.



- If you want to view files stored in the internal memory, remove your memory card.
- The camera will not properly play back files that are too large or those taken with cameras from other manufacturers.

Display in Playback mode

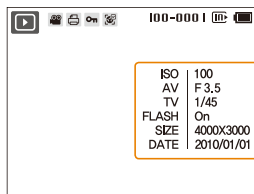

Information

Icon	Description
	Photo includes a voice memo
	Video file
	Print order has been set (DPOF)
	Protected file
	Photo includes a registered face; Available only when you use a memory card
100-0001	Folder name – File name

Ranking your favorite faces

You can change the ranking of your favorite faces or delete them. This feature is available only when you use a memory card.

- 1 In Playback mode, press **[MENU]**.
- 2 Select **File Options** → **Face List Edit** → **Edit Ranking**.
- 3 Select a face from the list and press **[OK]**.

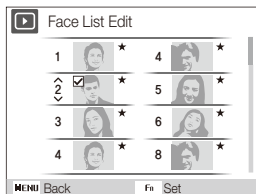

- 4 Press **[DISP]** or **[**] to change the ranking of the face, and press **[Fn]**.

Canceling your favorite faces

- 1 In Playback mode, press **[MENU]**.
- 2 Select **File Options** → **Face List Edit** → **Delete My Star**.
- 3 Select a face and press **[OK]**.
- 4 Press **[Fn]**.
- 5 Select **Yes**.

Viewing files by category in Smart Album

View and manage files by categories, such as date, file type, or week.

- 1 In Playback mode, rotate **[Zoom]** left.
- 2 Press **[MENU]**.

3 Select a category.

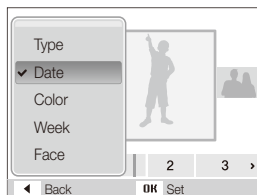

Option	Description
Type	View files by the file type.
Date	View files by the date they were saved.
Color	View files by the dominant color of the image.
Week	View files by the weekday they were saved.
Face	View files by recognized faces and favorite faces. (Up to 20 people)



It may take some time for the camera to open Smart Album or to change the category and recognize files.

- 4 Press **[⚡]** or **[⏪]** to scroll through files.
- Press and hold to scroll through files quickly.

- 5 Press **[OK]** to return to the normal view.

Viewing files as thumbnails

Scan thumbnails of files.



In Playback mode, rotate **[Zoom]** left to display 9 or 20 thumbnails (rotate **[Zoom]** right to return to the previous mode).

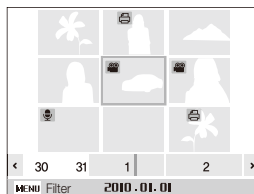

To	Do this
Scroll through files	Press [DISP] , [👉] , [⚡] , or [⏪] .
Delete files	Press [Fn] and select Yes .

Protecting files

Protect your files from accidental deletion.

- 1 In Playback mode, press **[MENU]**.
- 2 Select **File Options** → **Protect** → **Select**.
 - To protect all files, select **All** → **Lock**.
- 3 Select the file you want to protect and press **[OK]**.
 - Press **[OK]** again to cancel your selection.

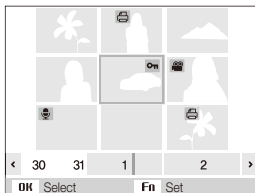

- 4 Press **[Fn]**.

Deleting files

Delete single files or all files at once. You cannot delete protected files.

To delete a single file,

- 1 In Playback mode, select a file and press **[Fn]**.
- 2 Select **Yes** to delete the file.

To delete multiple files,

- 1 In Playback mode, press **[Fn]**.
- 2 Select **Multiple Delete**.
- 3 Select files you want to delete and press **[OK]**.
 - Press **[OK]** again to cancel your selection.
- 4 Press **[Fn]**.
- 5 Select **Yes**.

To delete all files,

- 1 In Playback mode, press **[MENU]**.
- 2 Select **File Options** → **Delete** → **All** → **Yes**.

Copying files to the memory card

You can copy files from the internal memory to a memory card.

- 1 In Playback mode, press **[MENU]**.
- 2 Select **File Options** → **Copy to Card**.
- 3 Select **Yes** to copy files.

Viewing photos

Zoom in on part of a photo or view photos in a slide show.

Enlarging a photo

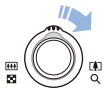

In Playback mode, rotate **[Zoom]** right to enlarge a photo (rotate **[Zoom]** left to reduce a photo).

The enlarged area and zoom ratio are indicated on the top of the screen. The maximum zoom ratio may vary depending on the resolution.

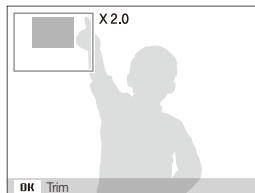

To	Do this
Move the enlarged area	Press [DISP] , [ZOOM] , [ZOOM] , or [ZOOM] .
Trim the enlarged photo	Press [OK] (it will be saved as a new file).

Starting a slide show

You can apply effects and audio to your slide show.

- 1 In Playback mode, press **[MENU]**.
- 2 Select **Multi Slide Show**.
- 3 Select a slide show effect option.
 - Skip to step 5 to start a slide show with no effects.

Option	Description
Images	Set the photos you want to view as a slide show. <ul style="list-style-type: none"> • All: View all photos in a slide show. • Date: View photos captured on a specific date in a slide show. • Select: View selected photos in a slide show.
Interval	<ul style="list-style-type: none"> • Set the interval between photos. • This is available when Off is selected in the effect option.
Music	Select a background audio.
Effect	<ul style="list-style-type: none"> • Select a transition effect. • Select Off for no effects.

- 4 Set the slide show effect.
- 5 Select **Start** → **Play**.
 - To loop the slide show, select **Repeat**.
 - Press **[OK]** to pause or resume the slide show.



To stop the slide show and switch to Playback mode, press **[OK]** and then **[⏏]** or **[⏮]**.

Playing a video

You can play a video, capture an image from a video, or crop a video.

- 1 In Playback mode, select a video and press **[OK]**.

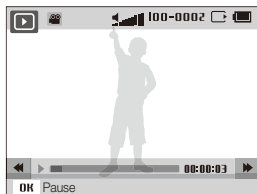

- 2 Use the following buttons to control playback.

Press	To
[↶]	Scan backward.
[OK]	Pause or resume playback.
[↷]	Scan forward.
[Zoom] left or right	Adjust the volume level.

Trimming a video during playback

- 1 Press **[OK]** at the point where you want the new video to begin and rotate **[Zoom]** right.
- 2 Press **[OK]** to resume playback.
- 3 Press **[OK]** at the point where you want the new video to end and rotate **[Zoom]** right.
- 4 Select **Yes**.



- The original video should be at least 10 seconds long.
- The edited video will be saved as a new file.

Capturing an image during playback

- 1 Press **[OK]** at the point where you want to save a still image.
- 2 Press **[👉]**.





- A captured image will have the same file size as the original video file and will be saved as a new file.

Playing voice memos

Playing a voice memo

- 1 In Playback mode, select a voice memo and press **[OK]**.
- 2 Use the following buttons to control playback.

Press	To
 [←]	Scan backward.
[OK]	Pause or resume playback.
 [→]	Scan forward.
 [⏏]	Stop playback.
[Zoom] left or right	Adjust the volume level.

Adding a voice memo to a photo

- 1 In Playback mode, select a photo and press **[MENU]**.
- 2 Select **File Options** → **Voice memo** → **On**.
- 3 Press **[Shutter]** to record a short voice memo (10 seconds maximum).
 - Press **[Shutter]** to stop recording a voice memo.

Playing a voice memo added to a photo

- In Playback mode, select a photo that includes a voice memo and press **[OK]**.
- Press **[OK]** to pause or resume playback.

Editing a photo

Perform photo editing tasks, such as resizing, rotating, eliminating red-eyes, and adjusting brightness, contrast, or saturation.



Edited photos will be saved as new files.

Resizing photos

- 1 In Playback mode, select a photo and press **[MENU]**.
- 2 Select **Edit** → **Resize** → an option.
 - Select  to save the photo as a start image. (p. 86)

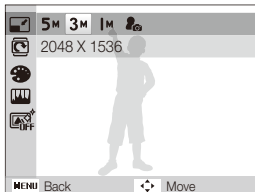

Available options differ depending on the size of the selected photo.

Rotating a photo

- 1 In Playback mode, select a photo and press **[MENU]**.
- 2 Select **Edit** → **Rotate** → an option.

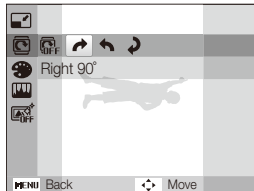

Applying photo styles

Apply a different photo style to the photo, such as Soft, Vivid, or Forest.



Soft



Vivid



Forest

- 1 In Playback mode, select a photo and press **[MENU]**.
- 2 Select **Edit** → **Photo Style Selector** → an option.
 - Select **Custom RGB** to define your own RGB tone.

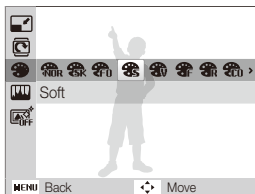

Defining your own RGB tone

- 1 In Playback mode, select a photo and press **[MENU]**.
- 2 Select **Edit** → **Photo Style Selector** → **Custom RGB**.
- 3 Select a color (R: Red, G: Green, B: Blue).

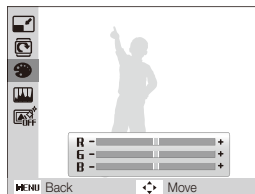

- 4 Adjust the amount of the selected color.
(-: less or +: more)

Applying smart filter effects

Apply various filter effects to your photos to create unique images.



Miniature



Vignetting



Fish-eye 1



Fish-eye 2

- 1 In Playback mode, select a photo and press **[MENU]**.
- 2 Select **Edit** → **Smart Filter**.
- 3 Select an effect.

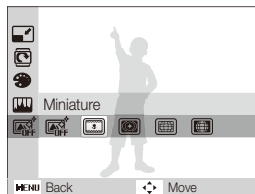

Correcting exposure problems

Adjust ACB (Auto Contrast Balance), brightness, contrast, or saturation; remove red-eye; hide facial imperfections; or add noise to the photo.

Adjusting ACB (Auto Contrast Balance)

- 1 In Playback mode, select a photo and press **[MENU]**.
- 2 Select **Edit** → **Image Adjust** → **ACB**.



Removing red-eye

- 1 In Playback mode, select a photo and press **[MENU]**.
- 2 Select **Edit** → **Image Adjust** → **Red-eye Fix**.

Hiding facial imperfections

- 1 In Playback mode, select a photo and press **[MENU]**.
- 2 Select **Edit** → **Image Adjust** → **Face Retouch**.
- 3 Select a level.
 - As the number increases, the face becomes clearer.

Adjusting brightness/contrast/saturation

- 1 In Playback mode, select a photo and press **[MENU]**.
- 2 Select **Edit** → **Image Adjust**.
- 3 Select an adjustment option.
 - : Brightness
 - : Contrast
 - : Saturation
- 4 Select a value to adjust the selected item.
(-: less or +: more)

Adding noise to the photo

- 1 In Playback mode, select a photo and press **[MENU]**.
- 2 Select **Edit** → **Image Adjust** → **Add Noise**.

Creating a print order (DPOF)

Select photos to be printed and set options, such as number of copies or paper size.



- The memory card can be taken to a print shop that supports DPOF (Digital Print Order Format) or you can print photos directly through a DPOF-compatible printer at home.
- Wide photos may print with the left and right edges cut off, so be aware of the dimensions of your photos.
- You cannot set the DPOF for the photos stored in the internal memory.

1 In Playback mode, press **[MENU]**.

2 Select **File Options** → **DPOF** → **Standard** → an option.

Option	Description
Select	Print the selected photos.
All	Print all photos.
Reset	Reset your settings.

3 If you select **Select**, scroll to a photo and rotate **[Zoom]** left or right to select the number of copies. Repeat for the photos you want and press **[Fn]**.

- If you select **All**, press **[DISP]** or **[👉]** to select the number of copies and press **[OK]**.

4 Press **[MENU]**.

5 Select **File Options** → **DPOF** → **Size** → an option.

Option	Description
Select	Specify the print size for the selected photo.
All	Specify the print size for all photos.
Reset	Reset your settings.

6 If you select **Select**, scroll to a photo and rotate **[Zoom]** left or right to select the print size. Repeat for the photos you want and press **[Fn]**.

- If you select **All**, press **[DISP]** or **[👉]** to select the print size and press **[OK]**.

Printing photos as thumbnails

1 In Playback mode, press **[MENU]**.

2 Select **File Options** → **DPOF** → **Index** → **Yes**.



If you specify the print size, you can print photos only with DPOF 1.1-compatible printers.

Viewing files on a TV or HDTV

Play back photos or videos by connecting your camera to a TV using the A/V cable.

- 1 In Shooting or Playback mode, press **[MENU]**.
- 2 Select **Settings** → **Video Out**.
- 3 Select a video signal output according to your country or region.
- 4 Turn off your camera and TV.
- 5 Connect your camera to your TV using the A/V cable.

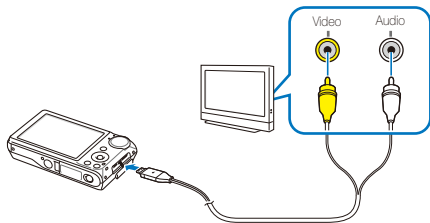

- 6 Turn on your TV and select the video output mode using the TV remote control.
- 7 Turn on your camera and press **[▶]**.
- 8 View photos or play videos using the buttons on your camera.



- On some TVs, digital noise may occur or part of an image may not appear.
- Images may not appear centered on the TV screen depending on your TV settings.
- You can capture photos or videos while the camera is connected to a TV.

Viewing files on an HDTV

You can view high-quality and uncompressed photos or videos on an HDTV using the optional HDMI cable. HDMI (High Definition Multimedia Interface) is supported by most HDTVs.

- 1 In Shooting or Playback mode, press **[MENU]**.
- 2 Select **Settings** → **HDMI Size**.
- 3 Select an HDMI resolution.
- 4 Turn off your camera and HDTV.

- 5 Connect your camera to your HDTV using the optional HDMI cable.

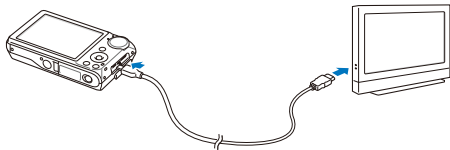

- 6 Turn on your camera.
- The HDTV will be powered on automatically and the camera screen will be displayed.
- 7 View files using the buttons on your camera or a remote control of your HDTV.



If your HDTV supports the Anynet+(CEC) profile, turn the Anynet+ on in the settings menu (p. 88) to control all connected Samsung AV devices with the TV remote control.

Transferring files to your computer (for Windows)

Transfer files to your computer using the built-in Intelli-studio program. You can also edit files or upload files to your favorite websites.

Requirements for Intelli-studio

Item	Requirements
CPU	Intel Pentium 4, 3.2 GHz or higher/ AMD Athlon™ FX 2.6 GHz or higher
RAM	Minimum 512 MB RAM (1 GB and above recommended)
OS	Windows XP SP2/Vista/7
Hard disk capacity	250 MB or more (1 GB or more recommended)
Others	<ul style="list-style-type: none">• CD-ROM drive• nVIDIA Geforce 7600GT or higher/ATI X1600 series or higher• 1024 x 768 pixels, 16-bit color display compatible monitor (1280 x 1024 pixels, 32-bit color display recommended)• USB port, Microsoft DirectX 9.0c or later



- Intelli-studio may not perform correctly on some computers, even when the computer meets the requirements.
- If your computer does not meet the requirements, videos may not play correctly or it may take longer to edit videos.
- Install DirectX 9.0c or above before you use the program.
- You must use Windows XP/Vista/7 or Mac OS 10.4 or later to connect the camera as a removable disk.



Using a self-assembled PC or a PC and OS that are not supported may void your warranty.

Transferring files using Intelli-studio

Intelli-studio will start automatically when you connect the camera to your computer with the USB cable.

 The battery will be charged while the camera is connected to a computer with the USB cable.

- 1 In Shooting or Playback mode, press **[MENU]**.
- 2 Select **Settings** → **PC Software** → **On**.
- 3 Turn off the camera.
- 4 Connect the camera to your computer with the USB cable.

 You must plug the end of the cable with the indicator light (▲) into your camera. If the cable is reversed, it may damage your files. The manufacturer is not responsible for any loss of data.

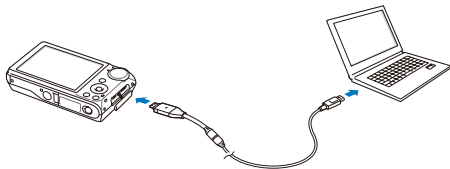

- 5 Turn on the camera.
 - The computer recognizes the camera automatically.
- 6 Select a folder on your computer to save new files.
 - If your camera has no new files, the pop-up window for saving new files will not appear.
- 7 Select **Yes**.
 - New files will be transferred to the computer.

 For Windows Vista, select **Run iStudio.exe** from the AutoPlay window.

Using Intelli-studio

Intelli-studio is a built-in program that allows you to play back and edit files. You can also upload files to websites, such as Flickr or YouTube. For details, select **Help** → **Help** in the program.



- If you install Intelli-studio on your computer, the program will launch more quickly. To install the program, select **Tool** → **Install Intelli-studio on PC**.
- You cannot edit files directly on the camera. Transfer files to a folder on your computer before editing.
- You cannot copy files in your computer to the camera.
- Intelli-studio supports the following formats:
 - Videos: MP4 (Video: H.264, Audio: AAC), WMV (WMV 7/8/9), AVI (MJPEG)
 - Photos: JPG, GIF, BMP, PNG, TIFF

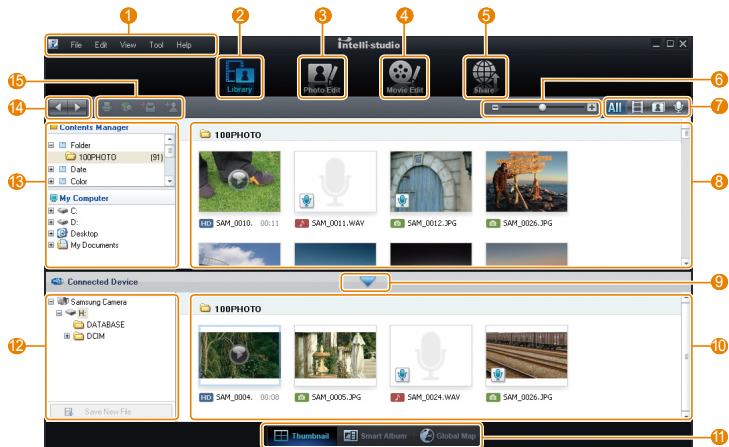

Icon	Description
1	Open menus
2	Display files in the selected folder
3	Change to the Photo edit mode
4	Change to the Video edit mode
5	Change to the Sharing mode (You can send files by email or upload files to websites, such as Flickr or YouTube.)
6	Enlarge or reduce the thumbnails in the list
7	Select a file type
8	View files of the selected folder on your computer
9	Show or hide files of the connected camera
10	View files of the selected folder on the camera
11	View files as thumbnails, in Smart Album, or on a map
12	Browse folders in the connected device
13	Browse folders in your computer
14	Move to the previous or next folder
15	Print files, view files on a map, store files in My Folder, or register faces

Transferring files by connecting the camera as a removable disk

You can connect the camera to your computer as a removable disk.

- 1 In Shooting or Playback mode, press **[MENU]**.
- 2 Select **Settings** → **PC Software** → **Off**.
- 3 Turn off the camera.
- 4 Connect the camera to your computer with the USB cable.



You must plug the end of the cable with the indicator light (▲) into your camera. If the cable is reversed, it may damage your files. The manufacturer is not responsible for any loss of data.

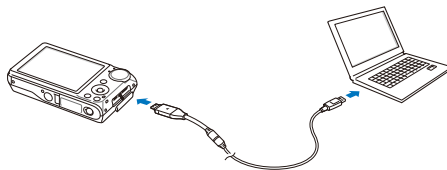

5 Turn on the camera.

- The computer recognizes the camera automatically.



If you set the USB option to **Select Mode**, select **Computer** from the pop-up window.

6 On your computer, select **My Computer** → **Removable Disk** → **DCIM** → **100PHOTO**.

7 Select the files you want and drag or save them to your computer.

Disconnecting the camera (for Windows XP)

The way to disconnect the USB cable for Windows Vista/7 is similar.

- 1 If the status lamp on your camera is blinking, wait until it stops.
- 2 Click  on the tool bar at the bottom right of your PC screen.



- 3 Click the pop-up message.
- 4 Remove the USB cable.



The camera may not be removed safely when Intelli-studio is running. End the program before disconnecting the camera.

Transferring files to your computer (for Mac)

When you connect the camera to a Macintosh computer, the computer will recognize the device automatically. You can transfer files directly from the camera to the computer without installing any programs.

 Mac OS 10.4 or later is supported.

1 Connect your camera to a Macintosh computer with the USB cable.

 You must plug the end of the cable with the indicator light (▲) into your camera. If the cable is reversed, it may damage your files. The manufacturer is not responsible for any loss of data.

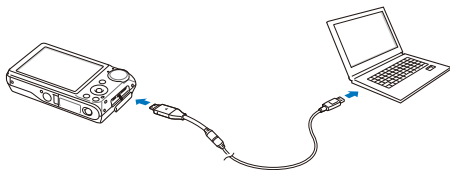

2 Turn on the camera.

- The computer recognizes the camera automatically and a removable disk icon will be displayed.

 If you set the USB option to **Select Mode**, select **Computer** from the pop-up window.

3 Double-click the removable disk icon.

4 Transfer photos or videos to the computer.

Printing photos with a photo printer (PictBridge)

Print photos with a PictBridge-compatible printer by connecting your camera directly to the printer.



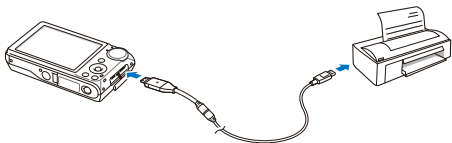



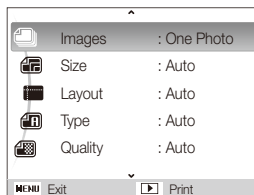

- 1 In Shooting mode, press **[MENU]**.
- 2 Select **Settings** → **USB**.
- 3 Select **Printer**.
- 4 With the printer on, connect your camera to the printer with the USB cable.



- 5 Turn on your camera.
 - The printer recognizes the camera automatically.
- 6 Press [**⚡**] or [**☺**] to select a photo.
 - Press **[MENU]** to set printing options. See "Configuring print settings."
- 7 Press **[OK]** to print.
 - Printing starts. Press [**⚡**] to cancel printing.

Configuring print settings



Option	Description
	Images: Select whether to print the current photo or all photos.
	Size: Specify the size of the print.
	Layout: Create thumbnail prints.
	Type: Select the type of paper.
	Quality: Set the printing quality.
	Date: Set to print the date.
	File Name: Set to print the name of the file.
	Reset: Reset the print options.



Some options are not supported by some printers.

Appendixes

Refer to settings, error messages, specifications, and maintenance tips.

Camera settings menu	85
Accessing the settings menu	85
Sound	86
Display	86
Settings	87
Error messages	90
Camera maintenance	91
Cleaning your camera	91
About memory cards	92
About the battery	93
Before contacting a service center	96
Camera specifications	99
Index	104



Camera settings menu

Learn about various options to configure your camera's settings.

Accessing the settings menu

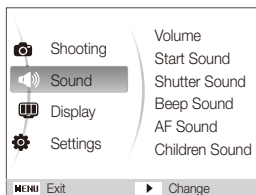
- 1 In Shooting or Playback mode, press **[MENU]**.
- 2 Select a menu.



Menu	Description
	Sound: Set various camera sounds and volume. (p. 86)
	Display: Customize the display settings, such as language and brightness. (p. 86)
	Settings: Change the settings for the camera system, such as memory format, default file name, and USB mode. (p. 87)

- 3 Select an option and save your settings.

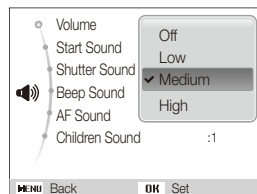

- 4 Press **[MENU]** to return to the previous screen.



Sound

* Default

Item	Description
Volume	Adjust the volume of any sound. (Off, Low, Medium*, High)
Start Sound	Select a sound to be emitted when turning on your camera. (Off*, 1, 2, 3)
Shutter Sound	Select a sound to be emitted when pressing the shutter button. (Off, 1*, 2, 3)
Beep Sound	Select a sound to be emitted when pressing the buttons or switching modes. (Off, 1*, 2, 3)
AF Sound	Set a sound to be emitted when half-pressing the shutter button. (Off, On*)
Children Sound	Set a sound to be emitted in the Children mode. (Off, 1*, 2, 3)

Display

* Default

Item	Description
Language	Select a language for the display text.
Function Description	Display a brief description of an option or menu. (Off, On*)
Start Image	<p>Set a start image to display when the camera turns on.</p> <ul style="list-style-type: none"> • Off*: Display no start image. • Logo: Display a default image stored in the internal memory. • User Image: Display the image you want. (p. 70)  <ul style="list-style-type: none"> • Only one start image will be saved in the internal memory. • If you select a new photo as a start image or reset your camera, the current image will be deleted. • A wide image or image in 3:2 ratio cannot be set as a start image.
Display Brightness	<p>Adjust the brightness of the screen. (Auto*, Dark, Normal, Bright)</p>  Normal is fixed in Playback mode even if Auto is selected.

* Default

Item	Description
Quick View	Set the duration for reviewing a captured image before returning to Shooting mode. (Off, 0.5 sec*, 1 sec, 3 sec)
Power Save	If you perform no operations for 30 seconds, the camera automatically switches to Power save mode (press any button to deactivate the Power save mode). (Off*, On)  If the Power save mode is deactivated, the main display will dim to save battery life when you perform no operations for about 30 seconds.

Settings



* Default

Item	Description
Format	Format the internal memory and the memory card (all files-including the protected files-will be deleted). (Yes, No)  If you use a memory card used with cameras from different manufacturers or a memory card reader, or one formatted on a computer, your camera may read the card incorrectly. Format the card before using it.

* Default

Item	Description
Reset	Reset menus and shooting options (date and time, language, and video output settings will not be reset). (Yes, No)
Date & Time	Set the date and time and select a date format. (Off*, dd/mm/yyyy, mm/dd/yyyy, yyyy/mm/dd)
Time Zone	Select a region and set the daylight-saving time (DST).
File No.	Specify how to name files. <ul style="list-style-type: none"> • Reset: Set the file number to start from 0001 when inserting a new memory card, formatting a memory card, or deleting all files. • Series*: Set the file number to follow the previous file number when inserting a new memory card, formatting a memory card, or deleting all files.  <ul style="list-style-type: none"> • The default name of the first folder is 100PHOTO and the default name of the first file is SAM_0001. • The file number increases one by one from SAM_0001 to SAM_9999. • The folder number increases one by one from 100PHOTO to 999PHOTO. • The maximum number of files that can be stored in one folder is 9999. • The camera defines file names according to the Digital rule for Camera File system (DCF) standard. If you change the names of files intentionally, the camera may not play back the files.

* Default

Item	Description
Imprint	<p>Set whether to display the date and time on your photos when printing. (Off*, Date, Date & Time)</p>  <ul style="list-style-type: none"> The date and time will be displayed on the bottom-right corner of the photo in yellow. The date and time may not be printed on some printer models. If you select Text in the SCN mode, the date and time will not be displayed.
Auto Power Off	<p>Set the camera to automatically turn off when you are not using it. (Off, 1 min, 3 min*, 5 min, 10 min)</p>  <ul style="list-style-type: none"> Your settings will not change after replacing the battery. The camera will not automatically turn off when: <ul style="list-style-type: none"> it is connected to a computer or printer you are playing a slide show or videos you are recording a voice memo
Video Out	<p>Set the video signal output according to your region.</p> <ul style="list-style-type: none"> NTSC*: USA, Canada, Japan, Korea, Taiwan, Mexico. PAL (supports only BDGHI): Australia, Austria, Belgium, China, Denmark, Finland, Germany, England, Italy, Kuwait, Malaysia, New Zealand, Singapore, Spain, Sweden, Switzerland, Thailand, Norway.

* Default

Item	Description
AF Lamp	<p>Set an assistant light to help you focus in dark places. (Off, On*)</p>
Anynet+ (HDMI-CEC)	<p>Set to control the camera connected to a Samsung HDTV that supports Anynet+(CEC) with the TV remote control.</p> <ul style="list-style-type: none"> On*: Control the camera with an HDTV remote control. Off: View files without using an HDTV remote control.
HDMI Size	<p>Select the resolution of photos when playing back files on an HDTV with the HDMI cable. (NTSC: 1080i*, 720p, 480p/ PAL: 1080i*, 720p, 576p)</p>  <ul style="list-style-type: none"> If the HDTV does not support the selected resolution, the HDTV automatically selects the next lower resolution. If you select 480p or 576p, the playback menus and Smart Album will not be available when connected to a TV.

* Default

Item	Description
USB	<p>Set the function to use via a USB connection with a computer or printer.</p> <ul style="list-style-type: none"> • Computer*: Connect your camera to a computer for transferring files. • Printer: Connect your camera to a printer for printing files. • Select Mode: Select a USB mode when you connect your camera to another device.
PC Software	<p>Set Intelli-studio to start automatically when you connect your camera to your computer. (Off, On*)</p>
Front Smile Shot	<p>Set the camera to automatically release the shutter when it detects a smiling face while using the Self-portrait mode. (On*, Off)</p>
Children Smile Shot	<p>Set the camera to automatically release the shutter when it detects a smiling face while using the Children mode. (On*, Off)</p>
Front Display Demo	<p>Set the camera to play the animation with sound through the front display when you turn it on (for shop display). (Off*, On)</p>  <ul style="list-style-type: none"> • In Demo mode, you cannot take photos or record videos. To switch to Shooting mode, press [OK]. • Demo mode is not available if you turn on the camera in Playback mode or when the camera is connected with another device.

Error messages

When the following error messages appear, try these remedies.

Error message	Suggested remedies
Card Error	<ul style="list-style-type: none">• Turn off your camera and then turn it on again.• Remove your memory card and insert it again.• Format your memory card. (p. 87)
Card not supported.	The inserted memory card is not available with your camera. Insert a microSD™ memory card.
DCF Full Error	File names do not match the DCF standard. Transfer the files on the memory card to your computer and format the card. (p. 87)
File Error	Delete the damaged file or contact a service center.
Low Battery	Insert a charged battery or recharge the battery.
Memory Full	Delete unnecessary files or insert a new memory card.
No Image File	Take photos or insert a memory card that has some photos.

Camera maintenance

Cleaning your camera

Camera lens and display

Use a blower brush to remove dust and wipe the lens gently with a soft cloth. If any dust remains, apply lens cleaning liquid to a piece of cleaning paper and wipe gently.

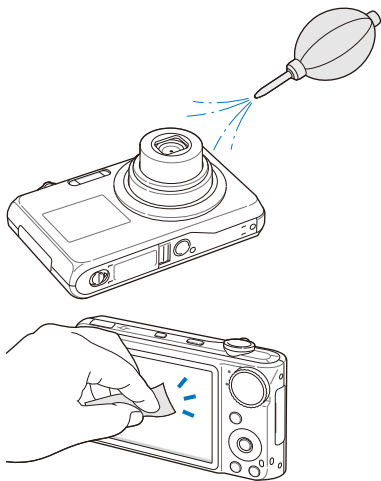

Camera body

Wipe gently with a soft, dry cloth.

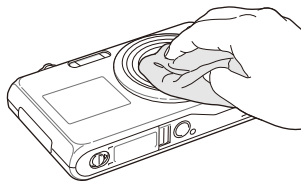

- Never use benzene, thinners, or alcohol to clean the device. These solutions can damage the camera or cause it to malfunction.
- Do not press on the lens cover or use a blower brush on the lens cover.

About memory cards

Memory cards you can use

You can use microSD™ (Secure Digital) memory cards.

Memory card capacity

The memory capacity may differ depending on shooting scenes or shooting conditions. These capacities are based on a 1 GB microSD™ card:

	Size	Super Fine	Fine	Normal	60 FPS	30 FPS	15 FPS
P h o t o s	12M	145	281	399	-	-	-
	10M	166	310	436	-	-	-
	9M	200	363	522	-	-	-
	8M	209	370	531	-	-	-
	5M	335	560	783	-	-	-
	3M	526	793	1,053	-	-	-
	2M	860	1,131	1,421	-	-	-
	1M	1,455	1,651	1,851	-	-	-
* V i d e o s	1280 HD	-	-	-	-	Approx. 12' 40"	Approx. 23' 07"
	1280	-	-	-	-	Approx. 14' 17"	Approx. 25' 46"
	640	-	-	-	-	Approx. 24' 43"	Approx. 47' 30"
	320	-	-	-	Approx. 50' 20"	Approx. 72' 37"	Approx. 93' 17"

* The recordable time may vary if you use the zoom.
Several videos were recorded in succession to determine the total recording time.

About the battery

Use only Samsung-approved batteries.

Battery specifications

Mode	SLB-07
Type	Lithium-ion battery
Cell capacity	760 mAh
Voltage	3.8 V
Charging time (when the camera is switched off)	Approx. 150 min

Battery life

Shooting time / Number of photos		Shooting conditions (when the battery is fully charged)
Photos	Approx. 100 min/ Approx. 200	<p>This is measured under the following conditions: in the AUTO mode, 12M resolution, Fine quality, OIS on.</p> <ol style="list-style-type: none"> 1. Set the flash option to Fill in, take a single shot, and zoom in or out. 2. Set the flash option to Off, take a single shot, and zoom in or out. 3. Perform steps 1 and 2 for 30 seconds and repeat for 5 minutes. Then turn off the camera for 1 minute. 4. Repeat steps 1 to 3.
Videos	Approx. 70 min	Record videos at 1280 X 720 HQ resolution and 30 fps.

- The figures above are measured by Samsung's standards and may differ depending on actual usage.
- Several videos were recorded in succession to determine the total recording time.

Notes about charging the battery

- If the indicator light is off, make sure that the battery is inserted correctly.
- Turn off your camera when charging.
- Turn on your camera after charging the battery for more than 10 minutes.
- Using the flash or recording videos depletes the battery quickly. Charge the battery until the indicator light turns green.
- If the indicator light blinks in orange or does not illuminate, reconnect the cable, or remove the battery and insert it again.
- If you charge the battery when the cable is overheated or the temperature is too high, the indicator light may turn orange. Charging will start when the battery cools down.

Notes about charging with a computer connected

- Use only the provided USB cable.
- The battery may not be charged when:
 - you use a USB hub
 - other USB devices are connected to your computer
 - you connect the cable to the port on the front side of your computer
 - the USB port of your computer does not support the power output standard (5 V, 500 mA)



Personal injury or death can occur if the battery is handled carelessly or improperly. For your safety, follow these instructions for proper battery handling:

- The battery can ignite or explode if not handled properly. If you notice any deformities, cracks, or other abnormalities in the battery, immediately discontinue use of the battery and contact your manufacturer.
- Use only authentic, manufacturer-recommended battery chargers and adapters and charge the battery only by the method described in this user manual.
- Do not place the battery near heating devices or expose to excessively warm environments, such as the inside of an enclosed car in the summertime.
- Do not place the battery in a microwave oven.
- Avoid storing or using the battery in hot, humid places, such as spas or shower enclosures.
- Do not rest the device on flammable surfaces, such as bedding, carpets, or electric blankets for a prolonged period.
- When the device is switched on, do not leave it in any confined space for a prolonged period.
- Do not allow battery terminals to come in contact with metallic objects, such as necklaces, coins, keys, or watches.
- Use only authentic, manufacturer-recommended, Lithium-ion replacement batteries.

- Do not disassemble or puncture the battery with any sharp object.
- Avoid exposing the battery to high pressure or crushing forces.
- Avoid exposing the battery to major impacts, such as dropping it from high places.
- Do not expose the battery to temperatures of 60 °C (140° F) or above.
- Do not allow the battery to come in contact with moisture or liquids.

Disposal guidelines

- Dispose of the battery with care.
- Do not dispose of the battery in a fire.
- Disposal regulations may differ by country or region. Dispose of the battery in accordance with all local and federal regulations.



Guidelines for charging the battery

Charge the battery only by the method described in this user manual. The battery can ignite or explode if not charged properly.

Before contacting a service center

If you are having trouble with your camera, try these troubleshooting procedures before contacting a service center. If you have attempted the troubleshooting solution and are still having problems with your device, contact your local dealer or service center.

Situation	Suggested remedies
Cannot turn on the camera	<ul style="list-style-type: none"> • Make sure that the battery is inserted. • Make sure that the battery is inserted correctly. • Charge the battery.
The power turns off suddenly	<ul style="list-style-type: none"> • Charge the battery. • Your camera may be in Power save mode. (p. 87) • The camera may turn off to prevent the memory card from being damaged due to an impact. Turn on your camera again.
The camera is losing battery power quickly	<ul style="list-style-type: none"> • The battery may lose power more quickly in low temperatures (below 0° C). Keep the battery warm by putting it into your pocket. • Using the flash or recording videos depletes the battery quickly. Recharge if needed. • Batteries are consumable parts that must be replaced over time. Get a new battery if the battery life is diminishing quickly.

Situation	Suggested remedies
Cannot take photos	<ul style="list-style-type: none"> • There is no space on the memory card. Delete unnecessary files or insert a new card. • Format the memory card. (p. 87) • The memory card is defective. Get a new memory card. • Make sure that the camera is switched on. • Charge the battery. • Make sure that the battery is inserted correctly.
The camera freezes	Remove the battery and insert it again.
The flash does not work	<ul style="list-style-type: none"> • The flash option may be set to Off. (p. 45) • You cannot use the flash in the  DUAL,  or some SCN modes.
The flash fires unexpectedly	The flash may fire due to static electricity. This is not a malfunction of the camera.
The date and time are incorrect	Set the date and time in the display settings menu. (p. 87)

Situation	Suggested remedies
The display or buttons do not work	Remove the battery and insert it again.
The camera screen works poorly	If you use your camera at low temperatures, it will cause the camera screen to malfunction or discolor. For better performance of your camera screen, use your camera at normal temperatures.
The memory card has an error	The memory card has not been reset. Format the card. (p. 87)
Cannot play back files	If you change the name of a file, your camera may not play the file (the name of the file should meet the DCF standard). If you encounter this situation, play back files on your computer.
The photo is blurry	<ul style="list-style-type: none"> • Make sure that the focus option you set is suitable for close-up shots. (p. 47) • Make sure that the lens is clean. If not, clean the lens. (p. 91) • Make sure that the subject is within range of the flash. (p. 99)
The colors in the photo do not match the actual scene	An incorrect white balance can create unrealistic color. Select the proper white balance option to suit the light source. (p. 55)

Situation	Suggested remedies
The photo is too bright	<ul style="list-style-type: none"> • Turn off the flash. (p. 45) • Your photo is overexposed. Adjust the exposure value. (p. 54)
The photo is too dark	Your photo is underexposed. <ul style="list-style-type: none"> • Turn on the flash. (p. 45) • Adjust the ISO speed. (p. 46) • Adjust the exposure value. (p. 54)
The TV does not display your photos	<ul style="list-style-type: none"> • Make sure that the camera is correctly connected to the external monitor with the A/V cable. • Make sure that your memory card contains photos.
Your computer does not recognize your camera	<ul style="list-style-type: none"> • Make sure that the USB cable is connected correctly. • Make sure that your camera is switched on. • Make sure that you are using a supported operating system.
Your computer disconnects the camera while transferring files	The file transmission may be interrupted by static electricity. Disconnect the USB cable and connect it again.

Situation	Suggested remedies
Your camera cannot play videos	<ul style="list-style-type: none">• You can play videos only with the Intelli-studio program. Install the program on your computer. (p. 79)• Make sure that the USB cable is connected correctly.
Intelli-studio is not functioning properly	<ul style="list-style-type: none">• End Intelli-studio and restart the program.• You cannot use Intelli-studio on Macintosh computers.• Make sure that the PC Software is set to On in the settings menu. (p. 89)• Depending on your computer's specification and environments, the program may not launch automatically. In this case, click Start → My Computer → Intelli-studio → iStudio.exe on your computer.

Camera specifications

Image sensor			
Type	1/2.33" (Approx. 7.79 mm) CCD		
Effective pixels	Approx. 12.4 mega-pixels		
Total pixels	Approx. 12.7 mega-pixels		
Lens			
Focal length	Samsung lens f = 4.9 - 24.5 mm (35 mm film equivalent: 27 - 135 mm)		
F-stop range	F3.5 (W) - F5.9 (T)		
Digital zoom	<ul style="list-style-type: none"> Still image mode: 1.0X - 5.0X Play mode: 1.0X - 12.5X (depending on image size) 		
Display			
Type	TFT LCD		
Feature	<ul style="list-style-type: none"> Main Display: 3.0" (7.6 cm) QVGA (230 K) Front Display: 1.5" (3.8 cm) 61 K TFT LCD 		
Focusing			
Type	TTL auto focus (Multi AF, Center AF, Face Detection AF, Tracking AF, Smart Face Recognition AF)		
Range		Wide (W)	Tele (T)
	Normal	80 cm - infinity	1 m - infinity
	Macro	5 cm - 80 cm	1 m - 1.5 m
	Auto Macro	5 cm - infinity	1 m - infinity

Shutter speed

- Auto: 1/8 - 1/2,000 sec.
- Program: 1 - 1/2,000 sec.
- Night: 8 - 1/2,000 sec.
- Fireworks: 2 sec.

Exposure

Control	Program AE
Metering	Multi, Spot, Center-weighted, Face Detection AE
Compensation	±2EV (1/3EV steps)
ISO equivalent	Auto, 80, 100, 200, 400, 800, 1600, 3200

Flash

Mode	Off, Auto, Red-eye, Fill in, Slow Sync, Red-eye Fix
Range	<ul style="list-style-type: none"> • WIDE: 0.2 m - 3.4 m (ISO Auto) • TELE: 0.5 m - 2.0 m (ISO Auto)
Recharging time	Approx. 4 sec. (depending on battery condition)

Shake reduction

DUAL IS [Optical Image Stabilization (OIS) + Digital Image Stabilization (DIS)]

Effect	
Shooting mode	<ul style="list-style-type: none"> • Photo Style Selector: Normal, Sketch, Defog, Soft, Vivid, Forest, Retro, Cool, Calm, Classic, Negative, Custom RGB • Image Adjust: Sharpness, Contrast, Saturation • Smart Filter: Normal, Miniature, Vignetting, Fish-eye 1, Fish-eye 2
White Balance	
Auto WB, Daylight, Cloudy, Fluorescent_H, Fluorescent_L, Tungsten, Custom Set	
Date Imprinting	
Date & Time, Date, Off	
Shooting	
Photos	<ul style="list-style-type: none"> • Modes: Smart Auto (White, Macro Color, Fireworks, Portrait, Night Portrait, Backlight Portrait, Macro Portrait, Backlight, Landscape, Action, Tripod, Night, Macro, Macro Text, Blue Sky, Sunset, Natural Green), Auto, Program, DUAL IS, Beauty Shot, Night, Scene (Frame Guide, Portrait, Landscape, Close Up, Text, Sunset, Dawn, Backlight, Fireworks, Beach & Snow) • Drive: Single, Continuous, Motion Capture, AEB • Timer: 10 Sec, 2 Sec, Double, Jump Shot

Videos	<ul style="list-style-type: none"> • Modes: Smart Scene Detection (Landscape, Blue Sky, Natural Green, Sunset Sky), Movie • Format: H.264 (MPEG-4, AVC) (Max recording time: 20 min) • Size: 1280 X 720 HQ (30 FPS, 15 FPS), 1280 X 720 (30 FPS, 15 FPS), 640 X 480 (30 FPS, 15 FPS), 320 X 240 (60 FPS, 30 FPS, 15 FPS) • Frame Rate: 60 FPS, 30 FPS, 15 FPS • Voice: Off, On (sound is muted when operating the zoom function) • OIS: On, Off • Video editing (embedded): Pause during recording, Still image capture, Time trimming
Playback	
Type	Single image, Thumbnails, Multi slide show, Movie clip, Smart Album * Smart Album category: Type, Date, Color, Week, Face
Edit	Resize, Rotate, Photo Style Selector, Image Adjust

Camera specifications

Effect	<ul style="list-style-type: none"> • Photo Style Selector: Normal, Sketch, Defog, Soft, Vivid, Forest, Retro, Cool, Calm, Classic, Negative, Custom RGB • Image Adjust: ACB, Red-eye Fix, Face Retouch, Brightness, Contrast, Saturation, Add Noise • Smart Filter: Normal, Miniature, Vignetting, Fish-eye 1, Fish-eye 2
Voice recording	
	<ul style="list-style-type: none"> • Voice Recording (Max 10 hours) • Voice Memo in a photo (Max. 10 sec.)
Storage	
Media	<ul style="list-style-type: none"> • Internal memory: Approx. 30 MB • External memory (Optional): <ul style="list-style-type: none"> - microSD™ card (up to 2 GB guaranteed) - microSDHC™ card (up to 8 GB guaranteed) <p>Internal memory capacity may not match these specifications.</p>
File format	<ul style="list-style-type: none"> • Photo: JPEG (DCF), EXIF 2.21, DPOF 1.1, PictBridge 1.0 • Video: H.264 (MPEG-4.AVC) • Audio: WAV

Image size	For 1GB microSD™				
			Super Fine	Fine	Normal
	12M	4000 X 3000	145	281	399
	10M	3984 X 2656	166	310	436
	9M	3840 X 2160	200	363	522
	8M	3264 X 2448	209	370	531
	5M	2560 X 1920	335	560	783
	3M	2048 X 1536	526	793	1,053
	2M	1920 X 1080	860	1,131	1,421
	1M	1024 X 768	1,455	1,651	1,851
These figures are measured under Samsung's standard conditions and may vary depending on shooting conditions and camera settings.					
Interface					
Digital output connector	USB 2.0				
Audio output	Mono (Internal speaker), Mono (Microphone)				
Video output	<ul style="list-style-type: none"> • A/V: NTSC, PAL (selectable) SCC-AV20 • HDMI 1.4: NTSC, PAL (selectable) 				
DC power input connector	20 pin, 4.4 V				

Camera specifications

Power source

Rechargeable
battery

Lithium-ion battery (SLB-07, 760 mAh)

The power source may differ depending on your region.

Dimensions (W x H x D)

99.2 x 59 x 19.9 mm

Weight

136.6 g (without battery and memory card)

Operating temperature

0 - 40° C

Operating humidity

5 - 85 %

Software

Intelli-studio

Specifications are subject to change without prior notice.



Correct Disposal of This Product (Waste Electrical & Electronic Equipment)



(Applicable in the European Union and other European countries with separate collection systems)

This marking on the product, accessories or literature indicates that the product and its electronic accessories (e.g. charger, headset, USB cable) should not be disposed of with other household waste at the end of their working life. To prevent possible harm to the environment or human health from uncontrolled waste disposal, please separate these items from other types of waste and recycle them responsibly to promote the sustainable reuse of material resources. Household users should contact either the retailer where they purchased this product, or their local government office, for details of where and how they can take these items for environmentally safe recycling. Business users should contact their supplier and check the terms and conditions of the purchase contract. This product and its electronic accessories should not be mixed with other commercial wastes for disposal.



Samsung Eco-mark

It is Samsung's own symbol mark is used to effectively communicate Samsung's environmental friendly product activities to the consumers. The mark represents Samsung's continuous effort on development of environmental conscious products.



Correct disposal of batteries in this product

(Applicable in the European Union and other European countries with separate battery return systems)

This marking on the battery, manual or packaging indicates that the batteries in this product should not be disposed of with other household waste at the end of their working life. Where marked, the chemical symbols Hg, Cd or Pb indicate that the battery contains mercury, cadmium or lead above the reference levels in EC Directive 2006/66. If batteries are not properly disposed of, these substances can cause harm to human health or the environment.

To protect natural resources and to promote material reuse, please separate batteries from other types of waste and recycle them through your local, free battery return system.

This Class [B] digital apparatus complies with Canadian ICES-003.

Index

A

ACB

- in Playback mode 73
- in Shooting mode 54

Adjusting

- Brightness 73
- Contrast
 - in Playback mode 73
 - in Shooting mode 60
- Saturation
 - in Playback mode 73
 - in Shooting mode 60
- Sharpness 60

AF Lamp 88

AF Sound 86

Anynet+ 88

Aperture 31

Auto Contrast Balance (ACB) 54

Auto mode 22

B

Battery

- Charging 94
- Life 93
- Specifications 93

Beauty Shot mode 32

Blink detection 51

Burst

- Auto Exposure Bracket (AEB) 57
- Continuous 57
- Motion capture 57

C

Camera shake 26

Capturing an image from a video 68

Children mode

- Photo 38
- Video 39

Cleaning

- Body 91
- Display 91
- Lens 91

Couple mode 38

D

Date and time 87

Deleting files 65

Demo mode 89

Digital Image Stabilization 33

Digital zoom 24

Disconnecting the device 81

Display brightness 86

Display type 21

DPOF 74

Dual IS mode 33

E

Editing 70

Enlarging 66

Error messages 90

Exposure 54

F

Face detection

- Blink Detection 51
- Normal 50
- Smart Face Recognition 52
- Smile Shot 51

Facial brightness 32

Facial imperfections 32

Flash

- Auto 46
- Fill in 46
- Off 45
- Red-eye 46
- Red-eye Fix 46
- Slow Sync 46

Focus area

- Center AF 49
- Multi AF 49
- Tracking AF 49

Focus distance

- Auto Macro 47
- Macro 47
- Normal (AF) 47

Format 87

Frame guide 31

Frame rate 34

Front display

- Camera layout 13
- Demo mode 89
- Shooting mode 37
- Turning on 23

Function button 14

Function description 86

H

Half-pressing 6

HDMI Size 88

HDTV 75

I

Icons 18

Image adjust

- ACB 73
- add noise 73
- brightness 73
- contrast 73
- face retouch 73
- red-eye fix 73
- saturation 73

Imprint 88

Intelli-studio 79

ISO speed 46

J

Jump shot 44

L

Light source (White balance) 55

Long time shutter 31

M

Macro 47

Maintenance 91

Memory card

- Capacity 92
- microSD 92

MENU button 14

Metering

- Center-weighted 55
- Multi 55
- Spot 55

Mode dial 14

Movie mode 34

Muting

- Camera 16
- Video 35

My Star

- Canceling faces 63
- Ranking 63
- Registering faces 53

N

Navigation button 14

Night mode 31

O

Optical Image Stabilization (OIS) 24, 33

P

Photo quality 42

Photo styles

- in Playback mode 71
- in Shooting mode 58

Playback button 16

Playback mode 62

Printing photos 83

Print order 74

Program mode 34

Protecting files 65

Q

Quick View 87

R

Recording

Video 34

Voice memo 40

Red-eye

in Playback mode 73

in Shooting mode 45

Reset 87

Resizing 70

Resolution

Photo 42

Video 42

RGB tone

in Playback mode 71

in Shooting mode 58

Rotating 70

S

Scene mode 30

Self-portrait mode

Photo 37

Video 39

Service center 96

Settings

Accessing 85

Camera 87

Display 86

Sound 86

Shooting mode

Auto 22

Beauty Shot 32

Dual IS 33

Movie 34

Night 31

Program 34

Scene 30

Smart Auto 29

Shutter speed 31

Slide show 67

Smart Album 63

Smart Auto mode 29

Smart Face Recognition 52

Smart filter effect

in Playback mode 72

in Shooting mode 59

Smart Scene Detection mode 36

Smile shot 51

Start image 86

T

Timer 43

Tracking focus 48

Transferring files

for Mac 82

for Windows 77

V

Video

Playing 68

Recording 34

Video Out 88

Viewing files

as thumbnails 64

by category 63

on TV 75

Slide show 67

Voice memo

Playing 69

Recording 40

Volume 86

W

White Balance 55

Z

Zoom button 14

Zooming 23



Please refer to the warranty that came with your product or visit our website <http://www.samsungimaging.com/> for after-sales service or inquiries.

