

SD Card/Hard Disk
Palmcorder®
CAMCORDER

Panasonic®

Operating Instructions
SD Card/Hard Disk Video Camera

Model No. **SDR-H40P/PC**

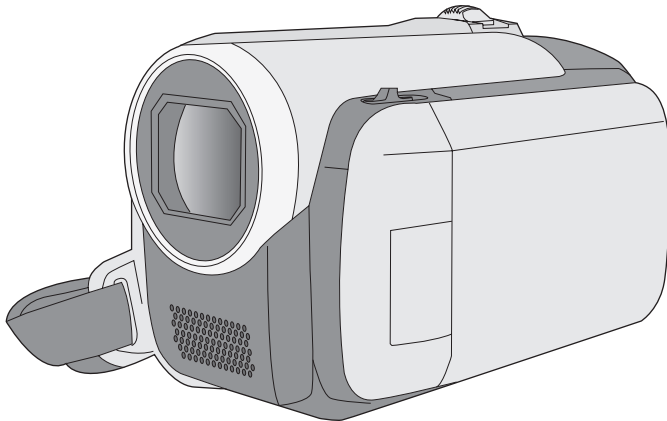

Before connecting, operating or adjusting this product, please read the instructions completely.
Spanish Quick Use Guide is included.
Guía para rápida consulta en español está incluida.



For USA assistance, please call: 1-800-211-PANA(7262) or, contact us via the web at: <http://www.panasonic.com/contactinfo>

For Canadian assistance, please call: 1-800-561-5505 or visit us at www.panasonic.ca

LSQT1337 A

Things You Should Know

Thank you for choosing Panasonic!

You have purchased one of the most sophisticated and reliable products on the market today. Used properly, we're sure it will bring you and your family years of enjoyment. Please take time to fill in the information on the right.

The serial number is on the tag located on the underside of your camera. Be sure to **retain this manual** as your convenient camera information source.

Date of Purchase

Dealer Purchased From

Dealer Address

Dealer Phone No.



Model No.

Serial No.

Safety Precautions

CAUTION: DANGER OF EXPLOSION IF BATTERY IS INCORRECTLY REPLACED.
REPLACE ONLY WITH THE SAME OR EQUIVALENT TYPE.

The following mark and symbols are located on bottom of the unit.

	CAUTION RISK OF ELECTRIC SHOCK DO NOT OPEN	
CAUTION: TO REDUCE THE RISK OF ELECTRIC SHOCK, DO NOT REMOVE SCREWS. NO USER-SERVICEABLE PARTS INSIDE. REFER SERVICING TO QUALIFIED SERVICE PERSONNEL.		



The lightning flash with arrowhead symbol, within an equilateral triangle, is intended to alert the user to the presence of uninsulated "dangerous voltage" within the product's enclosure that may be of sufficient magnitude to constitute a risk of electric shock to persons.



The exclamation point within an equilateral triangle is intended to alert the user to the presence of important operating and maintenance (servicing) instructions in the literature accompanying the appliance.

WARNING:

TO REDUCE THE RISK OF FIRE, ELECTRIC SHOCK OR PRODUCT DAMAGE,

- DO NOT EXPOSE THIS APPARATUS TO RAIN, MOISTURE, DRIPPING OR SPLASHING AND THAT NO OBJECTS FILLED WITH LIQUIDS, SUCH AS VASES, SHALL BE PLACED ON THE APPARATUS.
- USE ONLY THE RECOMMENDED ACCESSORIES.
- DO NOT REMOVE THE COVER (OR BACK); THERE ARE NO USER SERVICEABLE PARTS INSIDE. REFER SERVICING TO QUALIFIED SERVICE PERSONNEL.

CAUTION!

DO NOT INSTALL OR PLACE THIS UNIT IN A BOOKCASE, BUILT-IN CABINET OR IN ANOTHER CONFINED SPACE. ENSURE THE UNIT IS WELL VENTILATED. TO PREVENT RISK OF ELECTRIC SHOCK OR FIRE HAZARD DUE TO OVERHEATING, ENSURE THAT CURTAINS AND ANY OTHER MATERIALS DO NOT OBSTRUCT THE VENTILATION VENTS.

⚠ WARNING

- **AS WITH ANY SMALL OBJECT, SD CARDS CAN BE SWALLOWED BY YOUNG CHILDREN. DO NOT ALLOW CHILDREN TO HANDLE THE SD CARD.**

THE FOLLOWING APPLIES ONLY IN THE U.S.A.

FCC Note: This equipment has been tested and found to comply with the limits for a Class B digital device, pursuant to Part 15 of the FCC Rules. These limits are designed to provide reasonable protection against harmful interference in a residential installation. This equipment generates, uses, and can radiate radio frequency energy and, if not installed and used in accordance with the instructions, may cause harmful interference to radio communications. However, there is no guarantee that interference will not occur in a particular installation. If this equipment does cause harmful interference to radio or television reception, which can be determined by turning the equipment off and on, the user is encouraged to try to correct the interference by one or more of the following measures:

- Reorient or relocate the receiving antenna.
- Increase the separation between the equipment and receiver.
- Connect the equipment into an outlet on a circuit different from that to which the receiver is connected.
- Consult the dealer or an experienced radio/TV technician for help.

FCC Caution: To assure continued compliance, follow the attached installation instructions and use only shielded interface cables with ferrite core when connecting to computer or peripheral devices. Any changes or modifications not expressly approved by the party responsible for compliance could void the user's authority to operate this equipment.

Declaration of Conformity

Trade Name: Panasonic
Model No.: SDR-H40P
Responsible party: Panasonic Corporation of North America
One Panasonic Way, Secaucus, NJ 07094
Support Contact: Panasonic Consumer Electronics Company
1-800-211-PANA (7262)

This device complies with Part 15 of the FCC Rules. Operation is subject to the following two conditions: (1) This device may not cause harmful interference, and (2) this device must accept any interference received, including interference that may cause undesired operation.

Panasonic SDR-H40P

FC Tested To Comply
With FCC Standards

FOR HOME OR OFFICE USE

THE FOLLOWING APPLIES ONLY IN CANADA.

This Class B digital apparatus complies with Canadian ICES-003.

IMPORTANT SAFETY INSTRUCTIONS

Read these operating instructions carefully before using the unit. Follow the safety instructions on the unit and the applicable safety instructions listed below. Keep these operating instructions handy for future reference.

- 1) Read these instructions.
- 2) Keep these instructions.
- 3) Heed all warnings.
- 4) Follow all instructions.
- 5) Do not use this apparatus near water.
- 6) Clean only with dry cloth.
- 7) Do not block any ventilation openings. Install in accordance with the manufacturer's instructions.
- 8) Do not install near any heat sources such as radiators, heat registers, stoves, or other apparatus (including amplifiers) that produce heat.
- 9) Do not defeat the safety purpose of the polarized or grounding-type plug. A polarized plug has two blades with one wider than the other. A grounding type plug has two blades and a third grounding prong. The wide blade or the third prong are provided for your safety. If the provided plug does not fit into your outlet, consult an electrician for replacement of the obsolete outlet.
- 10) Protect the power cord from being walked on or pinched particularly at plugs, convenience receptacles, and the point where they exit from the apparatus.
- 11) Only use attachments/accessories specified by the manufacturer.

- 12) Use only with the cart, stand, tripod, bracket, or the table specified by the manufacturer, or sold with the apparatus. When a cart is used, use caution when moving the cart/apparatus combination to avoid injury from tip-over.



- 13) Unplug this apparatus during lightning storms or when it will be left unused for long periods of time.
- 14) Refer all servicing to qualified service personnel. Servicing is required when the apparatus has been damaged in any way, such as when the power-supply cord or plug is damaged, liquid has been spilled or objects have fallen into the apparatus, the apparatus has been exposed to rain or moisture, does not operate normally, or has been dropped.

Precautions

USE & LOCATION

WARNING

- **TO AVOID SHOCK HAZARD** ... Your camera and power supply should not be exposed to rain or moisture. Do not connect the power supply or operate your camera if it gets wet. Your camera has been designed for outdoor use, however it is not designed to sustain direct exposure to water, rain, sleet, snow, sand, dust, or a direct splashing from a pool or even a cup of coffee. This action could permanently damage the internal parts of your camera. Do not attempt to disassemble this unit. There are no user serviceable parts inside. Unplug your camera from the power supply before cleaning.

CAUTION

- **DO NOT AIM YOUR CAMERA AT THE SUN OR OTHER BRIGHT OBJECTS**
- **DO NOT EXPOSE YOUR CAMERA TO EXTENDED HIGH TEMPERATURE** ... Such as, in direct sunlight, inside a closed car, next to a heater, etc... This action could permanently damage the internal parts of your camera.

- **AVOID SUDDEN CHANGES IN TEMPERATURE** ... If the unit is suddenly moved from a cold place to a warm place, moisture may form on the HDD and inside the unit.
- **DO NOT LEAVE YOUR CAMERA OR THE POWER SUPPLY TURNED ON WHEN NOT IN USE.**
- **STORAGE OF YOUR CAMERA** ... Store and handle your camera in a manner that will not subject it to unnecessary movement (avoid shaking and striking). Your camera contains a sensitive pick-up device which could be damaged by improper handling or storage.

CARE

- **TO CLEAN YOUR CAMERA** ... Do not use strong or abrasive detergents when cleaning your camera body.
- **TO PROTECT THE LENS** ... Do not touch the surface of the lens with your hand. Use a commercial camera lens solution and lens paper when cleaning the lens. Improper cleaning can scratch the lens coating.
- **TO PROTECT THE FINISH OF YOUR CAMERA** ... Before handling your camera, make sure your hands and face are free from any chemical products, such as suntan lotion, as it may damage the finish.

■ Indemnity concerning recording content

The manufacturer shall in no event be liable for the loss of recordings due to malfunction or defect of this unit, its accessories or recordable media.

IMPORTANT

■ Carefully observe copyright laws

Whatever you have recorded and created can be used for your personal entertainment only. Under copyright laws, other materials cannot be used without obtaining permission from the holders of the copyrights.

Battery pack (Lithium ion battery pack)

- Use the specified unit to recharge the battery pack.
- Do not use the battery pack with equipment other than the specified unit.
- Do not get dirt, sand, liquids, or other foreign matter on the terminals.
- Do not touch the plug terminals (+ and -) with metal objects.
- Do not disassemble, remodel, heat or throw into fire.

If any electrolyte should come into contact with your hands or clothes, wash it off thoroughly with water.

If any electrolyte should come into contact with your eyes, never rub the eyes. Rinse eyes thoroughly with water, and then consult a doctor.

Warning

Risk of fire, explosion and burns. Do not disassemble, heat above 60 °C (140 °F) or incinerate.

AC adaptor

This AC adaptor operates on AC between 110 V and 240 V.

But

- In the U.S.A. and Canada, the AC adaptor must be connected to a 120 V AC power supply only.
- When connecting to an AC supply outside of the U.S.A. or Canada, use a plug adaptor to suit the AC outlet configuration.
- When connecting to a supply of greater than AC 125 V, ensure the cord you use is suited to the voltage of the AC supply and the rated current of the AC adaptor.
- Contact an electrical parts distributor for assistance in selecting a suitable AC plug adaptor or AC cord set.

The socket outlet shall be installed near the equipment and easily accessible. The mains plug of the power supply cord shall remain readily operable. To completely disconnect this apparatus from the AC Mains, disconnect the power supply cord plug from AC receptacle.

Product Identification Marking is located on the bottom of units.

U.S.A./CANADA CONSUMERS: ATTENTION:



A lithium ion/polymer battery that is recyclable powers the product you have purchased. Please call 1-800-8-BATTERY for information on how to recycle this battery.

-If you see this symbol-



Information on Disposal in other Countries outside the European Union

This symbol is only valid in the European Union.

If you wish to discard this product, please contact your local authorities or dealer and ask for the correct method of disposal.

Contents

Accessories.....	9
Features.....	10
Quick Guide.....	11

Preparation

Before using

1	Parts identification and handling.....	14
2	Power supply.....	18
	Charging the battery.....	18
	Inserting the battery.....	19
	Charging time and recordable time.....	20
	Connecting to the AC outlet.....	21
3	About HDD and SD cards.....	22
	About SD cards.....	23
	HDD handling.....	25
	Access lamp.....	25
4	Inserting/removing an SD card.....	26

Setup

1	Turning the unit on/off	
	Selecting a mode.....	27
2	Using the menu screen.....	28
	Language selection.....	29
	Menu list.....	29
3	Setting date and time.....	31
4	Adjusting LCD monitor.....	32

Recording

Recording (Basic)

1	Before recording.....	34
2	Recording motion pictures.....	35
	Recording modes and recordable time.....	37
3	Recording still pictures.....	38
	Number of pixels and picture quality ...	39
4	Recording functions.....	40
	Zoom in/out function.....	40
	Recording yourself.....	41
	Quick start.....	42
	Image stabilizer function.....	42

Recording (Advanced)

1	Recording functions of operation icons.....	43
	Operation icons.....	44
	Backlight compensation/Fade/Help mode/ MagicPix/Soft skin mode/Self-timer	
2	Recording functions of menus.....	47
	Menus.....	47
	Guideline/Aspect ratio/Wind noise reduction/Auto slow shutter	
3	Manual recording functions.....	48
	Scene mode.....	49
	Manual focus adjustment.....	50
	White balance.....	50
	Manual shutter speed/aperture adjustment.....	52

Playback

Playback

1	Motion picture playback.....	54
2	Still picture playback.....	57

Editing

1	Deleting scenes/files.....	59
	Deleting scenes/files one at a time.....	59
	Deleting multiple scenes/files.....	59
	Deleting the copied scenes collectively.....	60
2	Editing scenes.....	61
3	Using playlists.....	64
	Creating a new playlist.....	64
	Editing a playlist.....	65
4	Editing still pictures.....	67

Media management

1	HDD and SD card management.....	71
	Formatting HDD.....	71
	Displaying HDD information.....	71
	Formatting an SD card.....	71

With other products

1 Playback on TV	72
2 With a DVD burner	73
Connecting this unit to the DVD burner	74
DVD COPY function	75
FAVOURITE SCENES function	76
Notes for copying data to discs using the DVD burner	78
Playing back a disc inserted in the DVD burner	79
3 With other video devices	80
Recording (dubbing) images onto other video devices	80
4 With a printer (PictBridge)	81

With a PC

Before using

1 What you can do with a PC	84
2 Operating environment	85
End User License Agreement	87

Setup

1 Installation	88
Installing VideoCam Suite	88
Uninstalling the software	89
2 Connection and recognition	90
About the PC display	90
To disconnect USB cable safely	91

Using software

1 Using VideoCam Suite	92
Reading the operating instructions of the software	92
DVD COPY function	93

Using a Macintosh

1 If using a Macintosh	94
-------------------------------------	-----------

Others

Indications

1 Indications	96
2 Messages	99

Helpful hints

1 Functions that cannot be used simultaneously	101
2 Frequently asked questions	102
3 Troubleshooting	104

Cautions for use

Explanation of terms

Specifications

Number of recordable pictures on the HDD or an SD card	117
--	-----

Optional accessories

Accessory Order Form (For USA Customers)	119
--	-----

Request for Service Notice

(USA Only)

Limited Warranty

(For USA Customers)

Customer Services Directory

Warranty (For Canadian Customers)

Index

Spanish Quick Use Guide/Guía española

para el uso rápido

Accessories

Check the accessories before using this unit.

Battery pack
VW-VBG070A



AV cable
K2KZ9CB00002



AC adaptor
VSK0697



USB cable
K1HA05CD0017



AC cable
K2CA2CA00029 or
K2CA2CA00025



CD-ROM
LSFT0757



DC cable
K2GJ2DC00021



Features

Extended recording!

Since motion pictures are recorded on the HDD in this unit, it is possible to record images for many hours without changing the media, such as tapes and discs. It is also possible to record motion pictures and still pictures on an SD card.

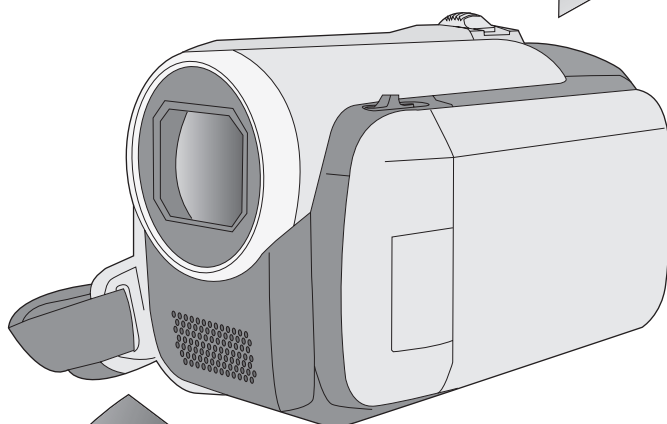

Using with a DVD burner!

Use the DVD burner to create the backup discs for motion pictures and still pictures recorded on this unit without using a PC. (→ 73)

Using with a PC!

If you use the supplied software, you can create a backup DVD of the scenes recorded on this unit.

You can also make an original DVD-Video by exporting the scenes to a PC and then editing them. (→ 84)

Quick Guide

■ Charging the battery

- 1 Connect the AC cable to the AC adaptor and the AC outlet.
- 2 Insert the battery into the battery charger by aligning the arrows.

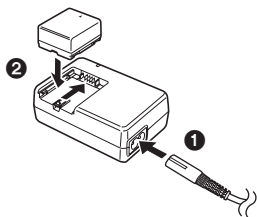

■ Inserting the battery

Insert the battery until it clicks while paying attention to the direction of the battery.

- A Push the center of the battery until it locks.

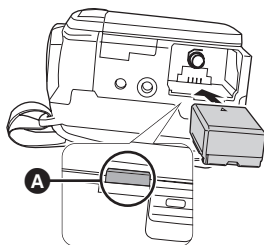

■ Removing the battery

While pressing the button A, move B in the direction of the arrow to unlock it and then remove the battery.

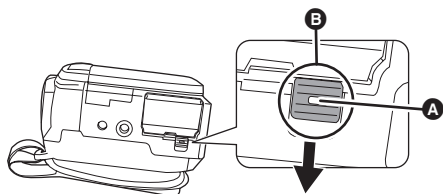

■ How to turn on the power

While pressing the lock release button A, set the mode dial to , , or .

- Align with the status indicator B.

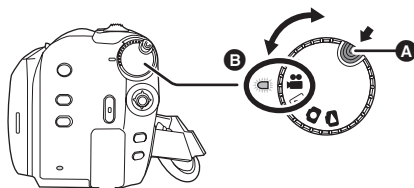

- To turn off the power, set the mode dial to OFF.

■ Inserting an SD card

- 1 Open the SD card slot cover then insert the SD card into the card slot.

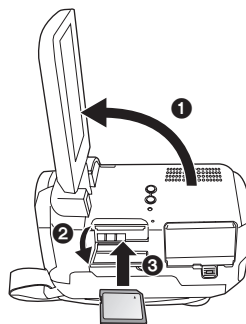

- 2 Securely close the SD card slot cover.

■ Recording motion pictures

- Rotate the mode dial to select .

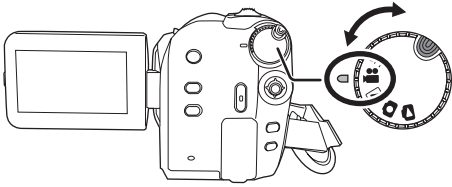

- 1 Press the MENU button, then select [MEDIA SELECT] → [HDD] or [SD CARD] to select the recording destination and press the joystick.
- 2 Press the recording start/stop button to start recording.

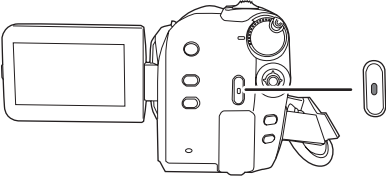

- 3 Press the recording start/stop button again to pause recording.

■ Recording still pictures

- Rotate the mode dial to select .

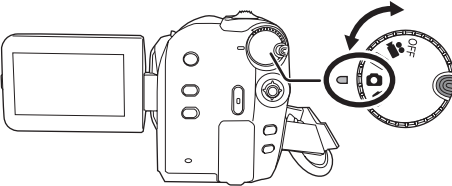

- 1 Press the MENU button, then select [MEDIA SELECT] → [HDD] or [SD CARD] to select the recording destination and press the joystick.
- 2 Press the recording start/stop button.

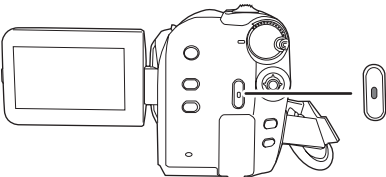

■ Playback

- Rotate the mode dial to select  or .

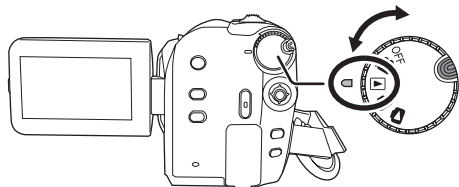





- 1 Press the MENU button, then select [MEDIA SELECT] → [HDD] or [SD CARD] to select the desired medium and press the joystick.
- 2 Select the scene/file to be played back, then press the joystick.







- 3 Select the playback operation with the joystick.



Motion picture playback

- : Playback/Pause
- : Skip playback (backward)
- : Skip playback (forward)
- : Stops the playback and shows the thumbnails.

Still picture playback

- : Slide show start/pause.
- : Plays back the previous picture.
- : Plays back the next picture.
- : Stops the playback and shows the thumbnails.

Preparation

Recording

Playback

With a PC

Others

14 Before using

27 Setup

Parts identification and handling

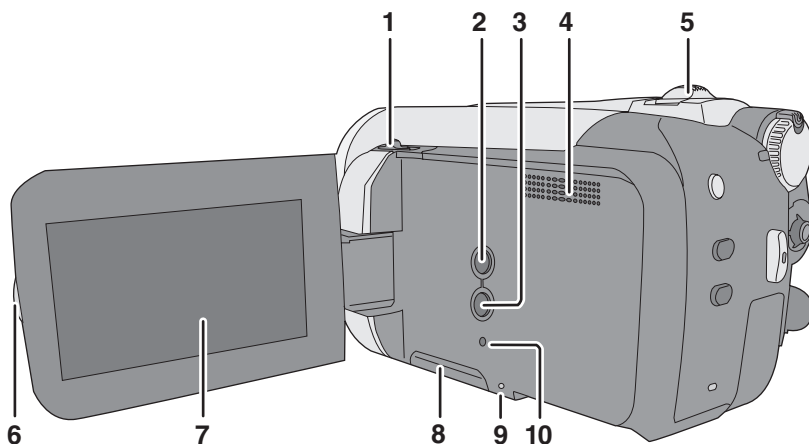

- 1 **Open/close switch for the lens cover**
- 2 **Auto button [AUTO] (→ 34)**
- 3 **Manual button [MANUAL AF/MF] (→ 48)**
- 4 **Speaker**
- 5 **When recording: Zoom lever [W/T] (→ 40)**
When playing back: Volume lever
[-VOL+] (→ 55)
- 6 **LCD monitor open part**
- 7 **LCD monitor**

Due to limitations in LCD production technology, there may be some tiny bright or dark spots on the LCD monitor screen. However, this is not a malfunction and does not affect the recorded picture.

- 8 **SD card slot cover [SD CARD] (→ 26)**
- 9 **SD card access lamp [ACCESS] (→ 25, 90)**
- 10 **Reset button [RESET] (→ 107)**

Lens cover

For the lens protection, be sure to close the lens cover when not in use.

Slide open/close switch for the lens cover.

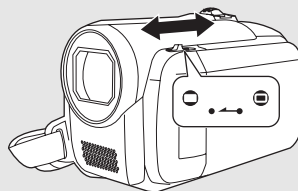

LCD monitor

Pull the LCD monitor out in the direction of the arrow with your fingers.

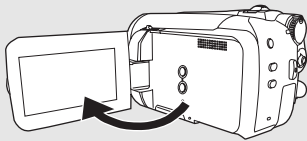

- It can open up to 90°.

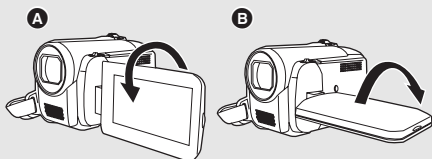

- It can rotate up to 180° **A** towards the lens or 90° **B** towards the opposite direction.
- The brightness and color level of the LCD monitor can be adjusted. (→ 32)

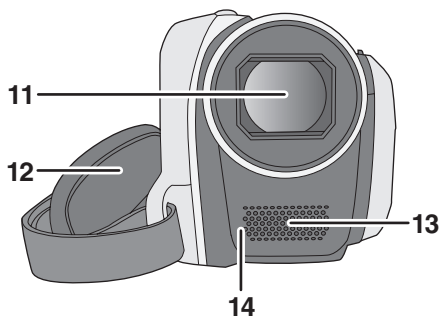

- 11 Lens
- 12 Grip belt
- 13 Microphone (built-in, stereo)
- 14 White balance sensor (→ 51)

Grip belt

Adjust the belt length and the pad position.

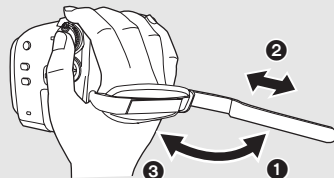

- 1 Flip the belt.
- 2 Adjust the length.
- 3 Replace the belt.

(U.S.A. only):

When this unit is purchased, a sensor tag is attached to the grip belt. Remove the tag before use.

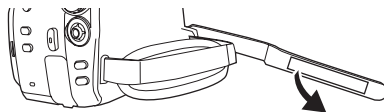

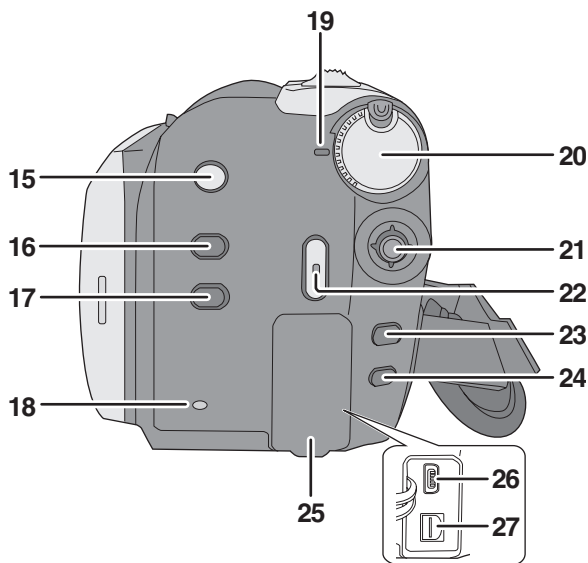

- 15 Image stabilizer button [], O.I.S.] (→ 42)
- 16 Power LCD plus button [POWER LCD PLUS] (→ 32)
- 17 DVD COPY button [DVD COPY] (→ 93)
- 18 HDD access lamp [ACCESS HDD] (→ 25, 90)
- 19 Status indicator (→ 27)
- 20 Mode dial (→ 27)
- 21 Joystick
- 22 Recording start/stop button (→ 35, 38)
- 23 Menu button [MENU] (→ 28)
- 24 Delete button [] (→ 59)
- 25 Terminal cover
- 26 USB terminal [] (→ 74, 81, 90)
- 27 Audio-video output terminal [A/V] (→ 72, 80)

Joystick

Use the joystick to select the recording functions and playback operations, and to operate the menu screen.

Move the joystick up, down, left, or right to select a setting or scene, and then press the joystick to set it.



- ① Select by moving up, down, left, or right.
- ② Set by pressing the center.
 - Menu screen operations (→ 28)
 - To select the recording functions (→ 43)
 - To adjust manually (→ 48)
 - Playback operations (→ 54, 57)

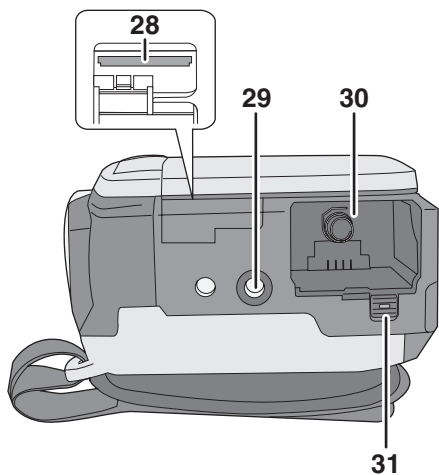

- 28 SD card slot (→ 26)
- 29 Tripod receptacle
- 30 Battery holder (→ 19, 21)
- 31 Battery release lever [BATTERY]
(→ 19, 21)

Tripod receptacle

This is a hole for attaching the unit to the optional tripod.

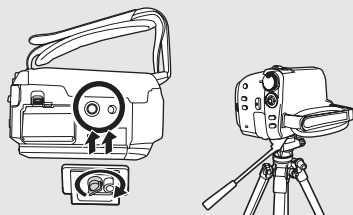

- When the tripod is used, the SD card slot cover cannot be opened. Insert an SD card and the battery before attaching this unit to the tripod. (→ 19, 26)

■ About batteries that you can use with this unit

The Panasonic battery that can be used with this unit is Supplied battery/VW-VBG130/VW-VBG260/VW-VBG6.

Supplied battery/VW-VBG130/VW-VBG260/VW-VBG6 come with a function to check whether the battery and unit can be safely used together.

- The battery pack holder kit VW-VH04 (optional) is necessary if using VW-VBG260/VW-VBG6.
- Batteries made by other companies which have been certified by Panasonic may be used with this unit, but we offer no guarantee as to the quality, performance or safety of such batteries.
- In order to safely use the unit we recommend that you use genuine Panasonic batteries which have been subject to our quality control process.
- We cannot accept any liability whatsoever for damages to the unit or accidents caused by non-genuine Panasonic batteries (including those that have been certified by Panasonic).
- Exercise care when purchasing batteries. Many fake or imitation batteries have been found among those sold at unusually low prices and those which customers cannot check for themselves before purchasing.

Charging the battery

When this unit is purchased, the battery is not charged. Charge the battery before using this unit.

Important:

If the DC cable is connected to the AC adaptor, the battery will not charge. Remove the DC cable from the AC adaptor.

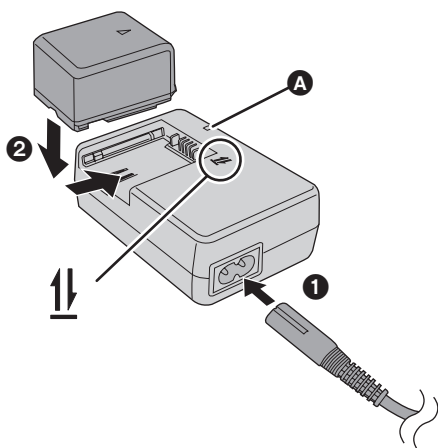

Charging lamp [CHARGE] **A**

Lights up:

Charging (→ 20, Charging time)

Goes off:

Charging completed

Flashing:

- When the battery temperature is excessively high or low, the lamp flashes and the charging time will be longer than normal.

- Remove dirt, foreign objects or dust on the terminals of the battery or the AC adaptor. If the lamp is still flashing, something may be wrong with the battery or AC adaptor.

Contact consumer support (→ 122, 123).

1 Connect the AC cable to the AC adaptor and the AC outlet.

2 Insert the battery on the battery charger by aligning the arrows.

- We recommend using Panasonic batteries. (→ 9, 20, 118)
- If you use other batteries, we cannot guarantee the quality of this product.

Inserting the battery

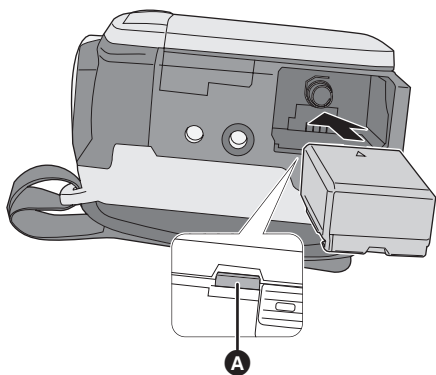

Removing the battery

While pressing button **B**, move **C** in the direction of the arrow to unlock it and then remove the battery.

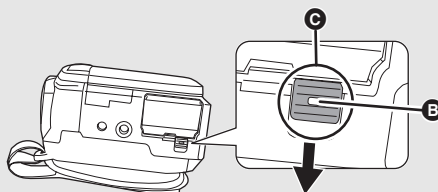

- Hold the battery with your hand so that it does not fall.

Insert the battery until it clicks while paying attention to the direction of the battery.

A Push the center of the battery until it locks.

- Be sure to set the mode dial to OFF and check that the status indicator is off before removing the battery.
- Do not heat or expose to flame.
- Do not leave a battery pack in an automobile exposed to direct sunlight for a long period of time with doors and windows closed.

CAUTION

Danger of explosion if battery is incorrectly replaced. Replace only with the same or equivalent type recommended by the manufacturer. Dispose of used batteries according to the manufacturer's instructions.

Charging time and recordable time

■ Charging time

- Temperature: 25 °C (77 °F)/humidity: 60%

Battery model number	Voltage/capacity	Charging time
Supplied battery	7.2 V/770 mAh	1 h 35 min
VW-VBG130 (optional)	7.2 V/1320 mAh	2 h 35 min
VW-VBG260 (optional)	7.2 V/2640 mAh	4 h 40 min
VW-VBG6 (optional)	7.2 V/5800 mAh	9 h 25 min

- If the temperature is higher or lower than 25 °C (77 °F), the charging time will become longer.

■ Recordable time

- Temperature: 25 °C (77 °F)/humidity: 60%

Battery model number	Voltage/capacity	Recording destination	Maximum continuously recordable time	Actual recordable time
Supplied battery	7.2 V/770 mAh	HDD	1 h 35 min	50 min
		SD	1 h 45 min	55 min
VW-VBG130 (optional)	7.2 V/1320 mAh	HDD	2 h 55 min	1 h 30 min
		SD	3 h 10 min	1 h 45 min
VW-VBG260 (optional)	7.2 V/2640 mAh	HDD	5 h 50 min	3 h 5 min
		SD	6 h 20 min	3 h 35 min
VW-VBG6 (optional)	7.2 V/5800 mAh	HDD	13 h 25 min	7 h 10 min
		SD	14 h 30 min	8 h 15 min

- These times are approximations.
- The actual recordable time refers to the recordable time when repeatedly starting/stopping recording, turning the unit on/off, moving the zoom lever, etc.
- The recordable times will vary depending on the status of use. The recordable time will become shorter when you use this unit with the LCD monitor lit up by pressing the POWER LCD PLUS button.
- Be aware that low temperatures will shorten the amount of time the battery will remain charged. We recommend carrying a spare battery.
- The batteries heat up after use or charging. This unit will also heat up while being used. This is not a malfunction.

Battery capacity indication

- The display changes to the following indications step-by-step as the battery capacity decreases.



- If the battery discharges, then  () will flash.

Connecting to the AC outlet

Important:

While the DC cable is connected to the AC adaptor, the battery will not charge.

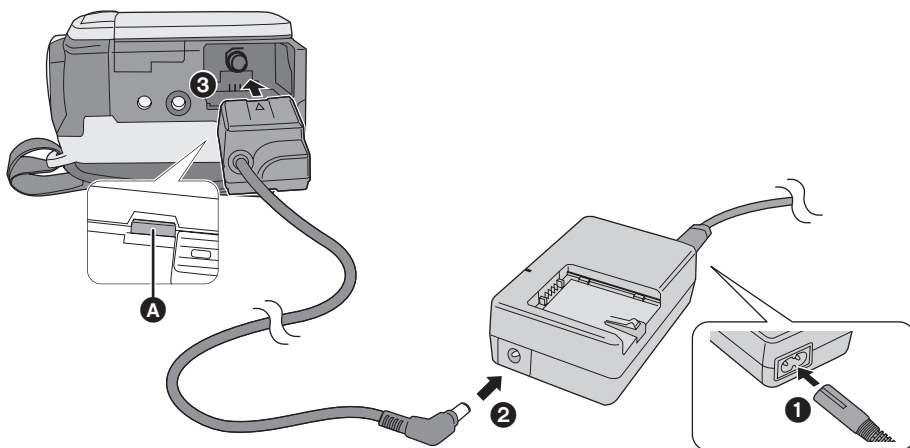

1 Connect the AC cable to the AC adaptor and the AC outlet.

2 Connect the DC cable to the AC adaptor.

3 Connect the DC cable to this unit.

A Push the center until it locks.

- Do not use the AC cable with any other equipment as it is designed only for this unit. Do not use the AC cable from other equipment with this unit.

Removing the DC cable

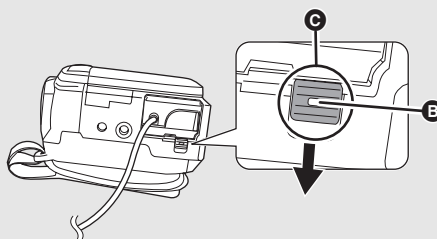

While pressing button **B**, move **C** in the direction of the arrow to unlock it and then remove the DC cable.



- Hold the DC cable with your hand so it does not fall.

About HDD and SD cards

This unit can be used for recording motion pictures and still pictures to the internal HDD and an SD card.

	Internal HDD (Hard Disk Drive)	SD Memory Card			SDHC Memory Card
Display on the screen					
Indication in these instructions	HDD	SD			
Capacity	40 GB* ¹	8 MB/ 16 MB	32 MB/ 64 MB/ 128 MB	256 MB/ 512 MB/ 1 GB/ 2 GB	4 GB/ 8 GB
Functions					
Recording motion pictures	●	–	●* ²	●	
Recording still pictures	●	●			
Creating playlists	●	–			

●: applicable –: not applicable

*¹ The 40 GB hard drive utilizes a portion of the storage space for formatting, file management and other purposes. 40 GB is 40,000,000,000 bytes. Usable capacity will be less.

*² Cannot be guaranteed in operation.

About SD cards

This unit is compatible with both SD Memory cards and SDHC Memory cards. You can only use SDHC Memory cards on devices that are compatible with them. You cannot use SDHC Memory cards on devices that are only compatible with SD Memory cards. (When using an SDHC Memory card on another device, be sure to read the operating instructions for that device.)

- For the purposes of these operating instructions, SD Memory Card and SDHC Memory Card are referred to as the “SD card”.
- Please confirm the latest information on the following website. (This website is in English only.)
http://panasonic.jp/support/global/cs/e_cam
- This unit supports SD Memory Cards formatted in FAT12 system and FAT16 system based on SD Memory Card Specifications and SDHC Memory Cards formatted in FAT32 system.
- If you wish to use Memory Cards that are 4 GB and 8 GB only SDHC Memory Cards can be used.
- 4 GB (or more) Memory Cards that do not have the SDHC logo are not based on SD Memory Card Specifications.
- Use this unit to format SD cards. If an SD card is formatted on other products (such as a PC), the time spent for recording may become longer and you may not be able to use the SD card. (→ 71)
- We recommend that you use a Panasonic brand SD card.
- When using an SD card on which data has been written many times, the remaining time left for recording may be reduced.
- When the write-protect switch **A** on SD card is locked, no recording, deletion or editing will be possible on the card.
- Keep the Memory Card out of reach of children to prevent swallowing.
- A MultiMediaCard cannot be used on this unit.

■ About the miniSD Card

- Be sure to insert miniSD Cards in the dedicated card adaptor before use. Inserting a card in this unit without the adaptor may damage the unit or the card.
- Do not insert an empty card adaptor in this unit. Do not leave the adaptor in this unit while inserting or removing miniSD Cards. This may cause the unit to malfunction.

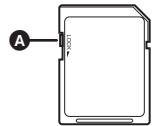

About SD cards that you can use for motion picture recording

We recommend using SD cards conforming to Class 2 or higher of the SD Speed Class Rating or the following SD cards made by Panasonic for motion picture recording. (If another kind of SD card is used, the recording may suddenly stop during motion picture recording.)

	High Speed SD Memory Card	Class 2 SD/SDHC Memory Card	Class 4 SD/SDHC Memory Card	Class 6 SD/SDHC Memory Card
256 MB	RP-SDH256	RP-SDR256	–	–
512 MB	RP-SDK512	RP-SDR512	–	–
1 GB	RP-SDH01G	RP-SDR01G	–	RP-SDV01G
2 GB	RP-SDK02G	RP-SDR02G	RP-SDM02G	RP-SDV02G
4 GB	–	RP-SDR04G	RP-SDM04G	RP-SDV04G
8 GB	–	–	–	RP-SDV08G

- Operation in motion picture recording is not guaranteed with the following SD cards.
 - SD cards from 32 MB to 128 MB
 - SD cards from 256 MB to 8 GB other than the ones mentioned above

SD card handling

- Do not touch the terminals on the back of the card.
- Do not expose the terminals of the card to water, garbage or dust.
- Do not leave SD card in the following areas:
 - In direct sunlight.
 - In very dusty or humid areas.
 - Near a heater.
 - Locations susceptible to significant difference in temperature (condensation can occur).
 - Where static electricity or electromagnetic waves occur.
- To protect SD cards, keep them in their cases when not being used.
- Electrical noise, static electricity, or failure of this unit or the SD card may damage or erase the data stored on the SD card. We recommend saving the SD data to a PC.

HDD handling

This unit has an internal HDD. The HDD is a precision instrument so take care when handling it.

■ Do not cause any vibrations or impacts to this unit

The HDD may no longer be recognized or recording or playback may no longer be possible. In particular, do not cause any vibrations or impacts during recording or playback.

■ Do not drop this unit

The HDD may be damaged if this unit receives a strong impact due to being dropped etc.

This unit has a drop detection function to protect the HDD from impact if the unit is dropped. If it detects that the unit has been dropped during motion picture recording, the HDD protection operation sound may be recorded. Also if it detects that the unit is being continuously dropped, recording or playback may stop.

■ Take note of the temperature of this unit

It may no longer be possible to record or playback if the temperature of this unit is too high or low. A warning message will appear on this unit's LCD monitor if an irregularity in the temperature is detected. (→ 99)

■ Do not use the unit in a low pressure area

The HDD may be damaged if you use this unit where the altitude is more than 3000 m (9800 feet).

■ Back up important recorded data to protect it

Save recorded data periodically on a PC, DVD disc, etc. for backup purposes.

If the HDD fails, the recorded data cannot be repaired.

■ Cautions for disposing of this unit

Even if some scenes on the HDD are deleted or formatted, the information is seemingly erased but may still remain. To dispose of this unit, the physical destruction is recommended.

■ Indemnity about recorded content

Panasonic does not accept any responsibility for damages directly or indirectly due to any type of problems that result in loss of recording or edited content, and does not guarantee any content if recording or editing does not work properly. Likewise, the above also applies in a case where any type of repair is made to the unit (including any other non-HDD related component).

Access lamp

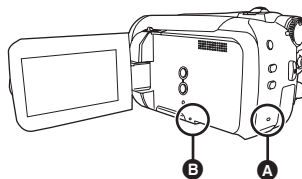

A HDD access lamp [ACCESS HDD]

- When this unit accesses the HDD, the lamp lights up.
- When lamp is on, do not
 - Expose the unit to strong vibrations or impacts
 - Operate the mode dial
 - Remove the battery or disconnect the AC adaptor
- Performing the above while lamp is on may result in damage to data/HDD or this unit.

B SD card access lamp [ACCESS]

- When this unit accesses the SD card, the lamp lights up.
- When lamp is on, do not
 - Open the SD card slot cover and remove the SD card
 - Operate the mode dial
 - Remove the battery or disconnect the AC adaptor
- Performing the above while lamp is on may result in damage to data/SD card or this unit.

Inserting/removing an SD card

Caution:

If the SD card is inserted or removed while the power is on, this unit may malfunction or the data recorded on the SD card may be lost.

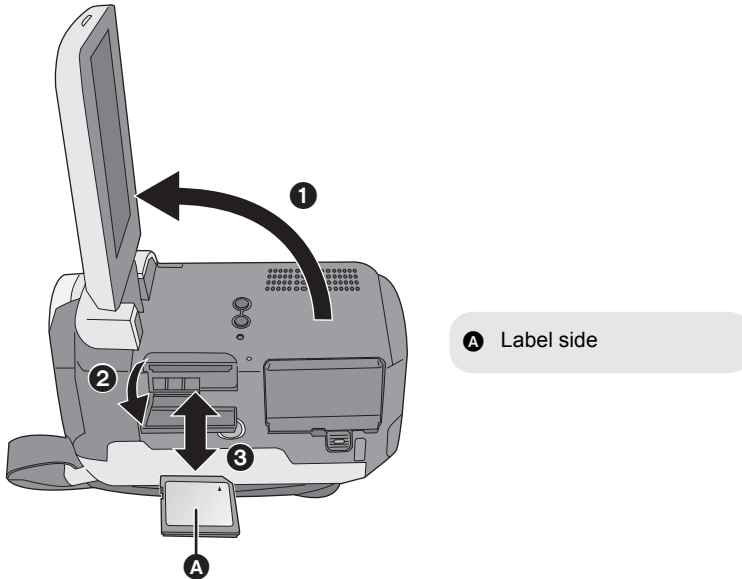
**1 Rotate the mode dial to OFF.**

- Check that the status indicator has gone off.

2 Open the LCD monitor and then open the SD card slot cover.**3 Insert/remove the SD card.**

- Press the SD card straight in as far as it will go.
- Press the center of the SD card and then pull it straight out.

4 Securely close the SD card slot cover.



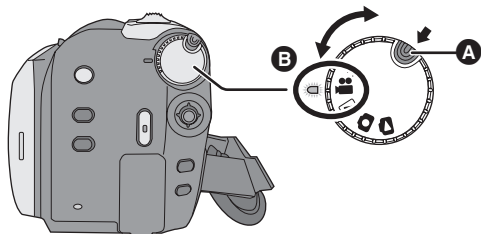

1

Turning the unit on/off Selecting a mode

Rotate the mode dial to switch to recording, playback or power OFF.



- Rotate the mode dial while at the same time pressing in the lock release button **A** if changing from OFF to another mode.
- Align with the status indicator **B**.

While pressing the lock release button, set the mode dial to , ,  or  to turn on the power.





The status indicator lights and the power turns on.

- When the unit is turned on for the first time, a message asking you to set the date and time will appear. Select [YES] and set the date and time. (→ 31)
- When the unit is turned on for the first time, the media select screen for recording will appear. Select [HDD] or [SD CARD] and press the joystick.



To turn off the power

Set the mode dial to OFF.

- The status indicator goes off and the power turns off.

	Video recording mode (→ 35)
	Video playback mode (→ 54)
	Picture recording mode (→ 38)
	Picture playback mode (→ 57)
OFF	

How to turn the power on and off with the LCD monitor

When the mode dial is set to  or , the power can be turned on and off with the LCD monitor.

■ To turn on

Open the LCD monitor.

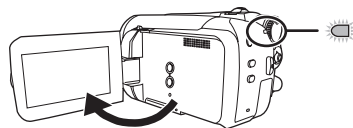

The status indicator lights.

■ To turn off

Close the LCD monitor.

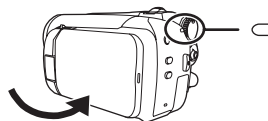

The status indicator goes off.

- When quick start is set to [ON], the status indicator flashes green. To turn off the power immediately after closing the LCD monitor, set quick start to [OFF]. (→ 42)

Set the mode dial to OFF when this unit is not being used.

Using the menu screen

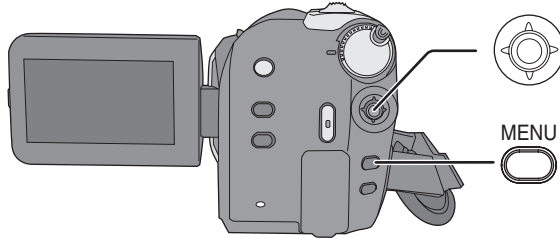

1 Press the MENU button.

The menu displayed differs depending on the position of the mode dial.

2 Select the desired top menu, then move the joystick right or press the joystick.

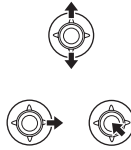

3 Select the submenu item, then move the joystick right or press the joystick.

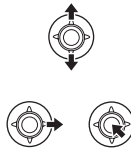
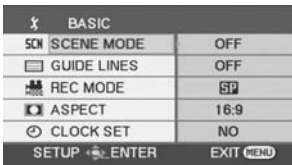

4 Select the desired setting, then press the joystick to enter the selection.

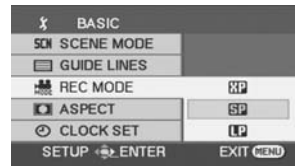

To get back to the previous screen

Move the joystick left.

To exit the menu screen

Press the MENU button.

- Do not switch the mode dial when the menu is displayed.
- The menu screen does not appear during recording or playing. You cannot start other operations while the menu screen is displayed.

Language selection

You can select the language displayed on the screen.

1 Press the MENU button, then select [LANGUAGE] and press the joystick.

2 Select [English] and press the joystick.

Menu list

Motion picture recording menus

■ [BASIC]

[SCENE MODE] (→ 49)

[GUIDE LINES] (→ 47)

[REC MODE] (→ 37)

[ASPECT] (→ 47)

[CLOCK SET] (→ 31)

■ [ADVANCED]

[D.ZOOM] (→ 40)

[FADE COLOR] (→ 45)

[WIND CUT] (→ 47)

[ZOOM MIC] (→ 41)

[AUTO SLW SHTR] (→ 47)

■ [MEDIA SELECT]

[HDD] (→ 35)

[SD CARD] (→ 35)

■ [SETUP]

[DISPLAY]

• [OFF]

• [ON]

The screen indications are selected as shown in the illustration below.

[OFF]

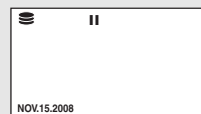

[ON]

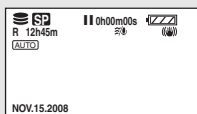

[DATE/TIME] (→ 31)

[DATE FORMAT] (→ 31)

[FORMAT CARD]^{*1} (→ 71)

[QUICK START] (→ 42)

[POWER SAVE]

• [OFF]

• [5 MINUTES]

[OFF]:

The power saving function is not activated.

[5 MINUTES]:

When about 5 minutes have passed without any operation, this unit automatically turns off to save battery life. To use this unit, turn it on again.

• When using the AC adaptor, connecting the unit to a PC, DVD burner or printer via the USB cable, the power saving function will not activate.

[AUDIO REC]^{*1} (→ 36)

[BEEP SOUND]

• [OFF]

• [ON]

This allows operations such as starting and ending recording to be signaled by a beep.

1 Beep

When you start recording

When you turn on the power

When this unit is recognized by the PC or the printer, etc.

2 Beeps

When you pause recording

When you turn off the power

2 Beeps for 4 times

When an error occurs e.g. recording not starting. Check the sentence displayed on the screen. (→ 99)

[LCD SET] (→ 32)

[INITIAL SET]

• [YES]

• [NO]



When there is a menu that cannot be selected due to another function or mode being activated, set to [YES] for changing the menu settings back to the default condition.

(The language setting cannot be changed back to the default condition.)

[DEMO MODE]

- [OFF]
- [ON]

This setting is used to start the unit demonstration.

(Only when using the AC adaptor and the mode dial is at the  or  position)

If you set this to [ON] without inserting an SD card, this unit is automatically set to the demonstration mode for introducing its functions. If any button is pressed or operated, the demonstration mode is canceled. If no operations take place for approx. 10 minutes, the demonstration mode automatically starts. To terminate the demonstration mode, set this to [OFF]. For normal use, set this function to [OFF].

■ [LANGUAGE] (→ 29)

Still picture recording menus

■ [BASIC]

[SCENE MODE] (→ 49)
[GUIDE LINES] (→ 47)
[PICTURE SIZE] (→ 39)
[PICT.QUALITY] (→ 39)
[CLOCK SET] (→ 31)

■ [ADVANCED]

[SHTR EFFECT] (→ 39)
[AUTO SLW SHTR] (→ 47)

■ [MEDIA SELECT]

[HDD] (→ 38)
[SD CARD] (→ 38)

■ [SETUP]

Refer to the motion picture recording menus.

■ [LANGUAGE] (→ 29)

Motion picture playback menus

■ [EDIT SCENE]

[LOCK SET] (→ 61)
[SPLIT&DELETE]^{*2} (→ 62)
[DELETE] (→ 59)

(In playlist playback mode)

■ [EDIT]

[ADD] (→ 66)
[MOVE] (→ 66)
[DELETE] (→ 59, 65)

■ [MEDIA SELECT]

[HDD] (→ 54)
[SD CARD] (→ 54)

■ [SETUP]

[RESUME PLAY] (→ 55)
[TV ASPECT] (→ 72)
[FORMAT HDD]^{*2} (→ 71)
[INFORMATION]^{*2} (→ 71)
[FORMAT CARD]^{*1} (→ 71)

For other items, refer to the motion picture recording menus.

■ [LANGUAGE] (→ 29)

Still picture playback menus

■ [PICT. SETUP]

[LOCK SET] (→ 67)
[DPOF SET]^{*1} (→ 68)
[COPY] (→ 69)
[DELETE] (→ 59)

■ [MEDIA SELECT]

[HDD] (→ 57)
[SD CARD] (→ 57)

■ [SETUP]

[TV ASPECT] (→ 72)
For other items, refer to the motion picture recording menus.

■ [LANGUAGE] (→ 29)

*1 Only when [MEDIA SELECT] is set to [SD CARD]

*2 Only when [MEDIA SELECT] is set to [HDD]

When the unit is turned on for the first time, a message asking you to set the date and time will appear. Select [YES] and press the joystick. Perform steps 2 and 3 below to set the date and time.

◇ Rotate the mode dial to select  or .

1 Select the menu. (→ 28)

[BASIC] → [CLOCK SET] → [YES]

2 Select the date or time, then adjust the desired value with the joystick.

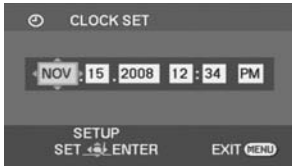

- The year will change as follows: 2000, 2001, ..., 2099, 2000, ...
- The 12-hour system is used to display the time.

3 Press the joystick to enter the selection.

- The clock function starts at [00] seconds when the joystick is pressed.

4 Press the MENU button to finish the setting.

- Check the date and time displayed.

■ Changing the date and time display mode

Select the menu. (→ 28)

[SETUP] → [DATE/TIME] → desired display style

[DATE]

NOV.15.2008

[D/T]

NOV.15.2008 12:34 PM

[OFF]

■ Changing the date format

Select the menu. (→ 28)

[SETUP] → [DATE FORMAT] → desired display style

Display style	Screen display
[Y/M/D]	2008.NOV.15
[M/D/Y]	NOV.15.2008
[D/M/Y]	15.NOV.2008

- The date and time function is driven by a built-in lithium battery.
- If the time display is [- -], the built-in lithium battery needs to be charged. Use the following steps to charge the battery, and then set the date and time.

To recharge the built-in lithium battery

Connect the AC adaptor or insert the battery to the unit, and the built-in lithium battery will be recharged. Leave the unit as it is for approx. 24 hours and the battery will save the date and time for approx. 6 months. (Even if the mode dial is set to OFF, the battery is still being recharged.)

- These settings will not affect the images actually recorded.

Adjusting the brightness and color level

1 Select the menu. (→ 28)

[SETUP] → [LCD SET] → [YES]

2 Select the item and then adjust the settings with the joystick.



[BRIGHTNESS]:

Brightness of the LCD monitor

[COLOR]:

Color level of the LCD monitor

Increasing and decreasing the brightness of the entire LCD monitor

Press the **POWER LCD PLUS** button.

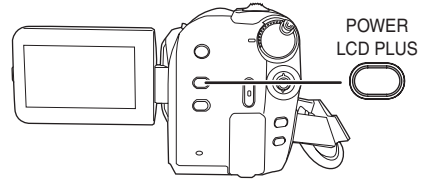

Each time you press the button:

- 1 Original brightness
- 2 Bright
- 3 Brighter
- 4 Darker
- 5 Dark

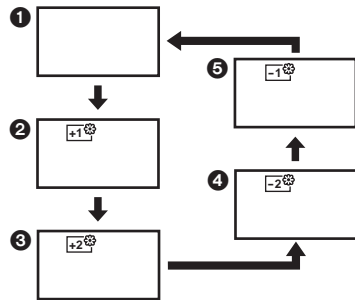

- If you turn on the unit when the AC adaptor is used, this function will automatically be "Bright".

Preparation

Recording

Playback

With a PC

Others

- 34** Recording (Basic)
- 43** Recording (Advanced)

Basic camera positioning

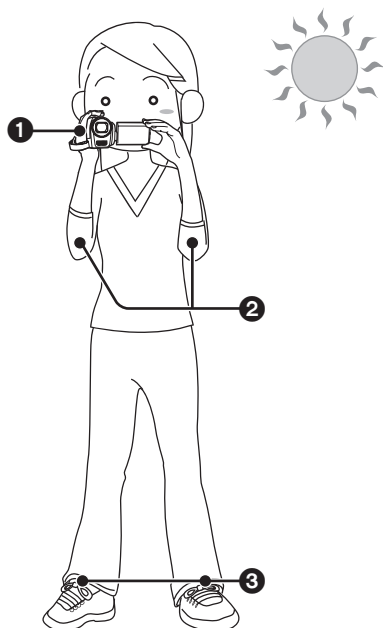

- ❶ Hold the camera with both hands. Put your hand through the grip belt. Do not cover the microphones or sensor with your hands.

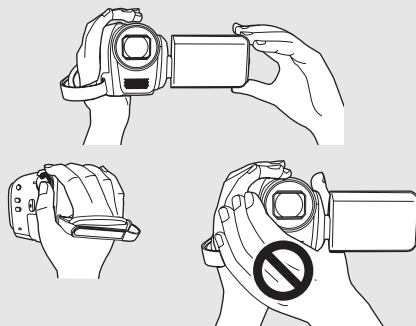

- ❷ Keep your arms near your body.
- ❸ Separate your legs for better balance.
 - When you are outdoors, record pictures with the sunlight behind you. If the subject is backlit, it will become dark in the recording.
 - When recording, make sure your footing is stable and there is no danger of colliding with another person or an object.

■ About auto mode

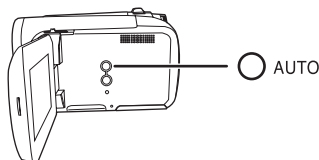

Press the AUTO button, color balance (white balance) and focusing will be adjusted automatically.

(The auto mode icon [**AUTO**] appears.)

- Auto white balance (→ 112)
- Auto focusing (→ 112)

Depending on the brightness of the subject etc., the aperture and shutter speed are automatically adjusted for optimum brightness.

(When set to the video recording mode:

The shutter speed is adjusted to a maximum of 1/250.)

- Color balance and focus may not be adjusted automatically depending on light sources or scenes. If so, manually adjust these settings. (→ 48)

HDD SD

- Open the lens cover before turning the unit on.

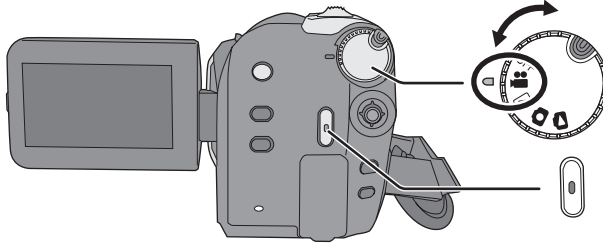

1 Rotate the mode dial to select  and open the LCD monitor.

2 Select the recording destination by the menu. (→ 28)

[MEDIA SELECT] → [HDD] or [SD CARD]

3 Press the recording start/stop button to start recording.



To end the recording

Press the recording start/stop button again.

- [●] and [||] are red during recording. Do not move this unit until [||] is green.

- The images recorded between pressing the recording start/stop button to start recording and pressing it again to pause recording become one scene.

The scene is automatically divided when the recorded data exceeds 3.9 GB. (The recording will continue.)

- When about 5 minutes have passed without any operation in recording pause, the unit automatically turns off to save battery life. To use the unit, turn it on again. This power save feature can also be set to [OFF]. (→ 29, [POWER SAVE])

■ Screen indications



- A Recording mode**
- B Selected recording destination**
- C Remaining time left for recording**
When the remaining time is less than 1 minute, [R 0h00m] flashes red.
- D Recording time elapsed**
Each time the unit enters the recording pause mode, the counter display will be reset to "0h00m00s".

-
- While motion picture recording is in progress, the recording will not stop even if the LCD monitor is closed.
 - While motion picture recording is in progress, do not disconnect the AC adaptor or remove the battery. If you do, a repair message may be displayed when the power is turned back on. (→ 100, About recovery)

Audio recording modes

SD

This mode switches the method for recording audio to an SD card.

- ◇ Select [SD CARD] in [MEDIA SELECT].

Select the menu. (→ 28)

[SETUP] → [AUDIO REC] → [DOLBY] or [MPEG]

[DOLBY] (Dolby AC-3):

This is a recording method suitable for copying motion pictures recorded on an SD card to a DVD disc by connecting the unit to a DVD burner.

[MPEG] (MPEG-1 Audio Layer 2):

This is a recording method suitable for playing back audio using a device conforming to the SD-Video standard.

-
- This unit is not capable of converting the audio recording method after recording motion pictures.
By using the supplied software, audio can be recorded in [DOLBY] mode on a disc and in [MPEG] mode on an SD card.
 - This function's default setting is [DOLBY].

Recording modes and recordable time

To change the picture quality of the motion picture

Select the menu. (→ 28)

[BASIC] → [REC MODE] → desired setting

■ HDD

Capacity	Recording mode		
	XP (High quality)	SP (Normal)	LP (Long play)
40 GB	9 h	18 h	36 h

Image quality prioritized ↔ Recording time prioritized

■ SD card

Capacity	Recording mode		
	XP (High quality)	SP (Normal)	LP (Long play)
256 MB	3 min	6 min	12 min
512 MB	6 min	12 min	25 min
1 GB	12 min	25 min	50 min
2 GB	25 min	50 min	1 h 40 min
4 GB	50 min	1 h 40 min	3 h 20 min
8 GB	1 h 40 min	3 h 20 min	6 h 40 min

Image quality prioritized ↔ Recording time prioritized

- The recordable times shown in the table are approximations.
 - This unit records in VBR (Variable Bit Rate). VBR recording automatically varies the bit rate (amount of data in a fixed time) depending on the subject being recorded. This means if a recording with a lot of movements is recorded, the recording time is reduced.
-
- Mosaic-pattern noise may appear on a playback image in the following cases.
 - When there is a complicated pattern in the background
 - When the unit is moved too fast
 - When a subject with sharp movements has been recorded (Particularly if it has been recorded in [LP] mode.)
 - If you record still pictures on the HDD or an SD card, the recordable time available for the motion picture will become shorter.

HDD SD

- Open the lens cover before turning the unit on.

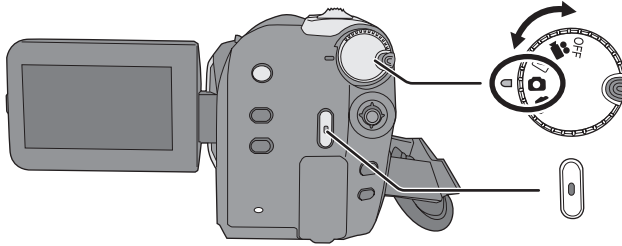

1 Rotate the mode dial to select  and open the LCD monitor.

2 Select the recording destination by the menu. (→ 28)

[MEDIA SELECT] → [HDD] or [SD CARD]

3 Press the recording start/stop button.

The unit automatically focuses on the subject at the center of screen (when auto focus is selected).

- About the number of recordable still pictures (→ 117)

■ Screen indications



- A** Size of still pictures
- B** Selected recording destination
- C** Remaining number of still pictures
Flashes in red when [R 0] appears.
- D** Quality of still pictures

■ To record still pictures clearly

- When zooming in on the subject with a magnification of 4× or higher, it is difficult to reduce the slight shaking from holding this unit by hand. We recommend decreasing the zoom magnification and approaching the subject when recording.
- When recording still pictures, hold the unit firmly with your hands and keep your arms stationary at your side so as not to shake the unit.
- You can record stable pictures without shaking by using a tripod.

Recording with a shutter sound effect

Select the menu. (→ 28)

[ADVANCED] → [SHTR EFFECT] → [ON]



- This function's default setting is [ON].

Number of pixels and picture quality

■ [PICTURE SIZE]

Select the menu. (→ 28)

[BASIC] → [PICTURE SIZE] → desired setting



Icon	Aspect	Number of pixels
	4:3	640×480
	16:9	640×360

- Default [PICTURE SIZE] is set to []. The sides of pictures recorded in a 16:9 aspect ratio may be cut when printed. Check before printing.

■ [PICT.QUALITY]

Select the menu. (→ 28)

[BASIC] → [PICT.QUALITY] → desired setting



- : Still pictures with a high picture quality are recorded.
- : Priority is given to the number of still pictures recorded. Still pictures are recorded in normal picture quality.

- If the [PICT.QUALITY] is set to [], mosaic-pattern noise may appear on a playback image depending on the picture content.

HDD SD

Zoom in/out function

You can zoom in up to 42x optically.

◇ Rotate the mode dial to select  or .

Move the zoom lever.

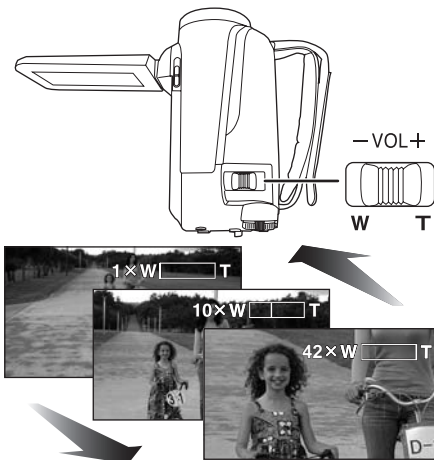

T side:

Close-up recording (zoom in)

W side:

Wide-angle recording (zoom out)

- The zoom speed varies depending on the range over which the zoom lever is moved.
- If you take your finger off the zoom lever during zoom operation, the operation sound may be recorded. When returning the zoom lever to the original position, move it quietly.
- When distant subjects are brought closer, they are focused at about 1.3 m (4.3 feet) or more.
- When the zoom magnification is 1x, this unit can focus on a subject approx. 2 cm (0.8") away from the lens. (Macro function)
- When the zoom speed is high, the subject may not be focused easily.

Digital zoom function

If the zoom magnification exceeds 42x, then the digital zoom function will be activated. The maximum magnification provided by the digital zoom can be switched.

◇ Rotate the mode dial to select .

Select the menu. (→ 28)

[ADVANCED] → [D.ZOOM] → desired setting

[OFF]: Optical zoom only (Up to 42x)

[70x]: Up to 70x

[2000x]: Up to 2000x

- If [70x] or [2000x] is selected, the digital zoom range is displayed in blue while zooming.

- The larger the digital zoom magnification, the more the image quality is degraded.
- This function cannot be used in picture recording mode.

To use the zoom microphone function

The zoom microphone is linked to the zooming operation so that far-away sounds with a tele-shot and close-up sounds with a wide-angle shot are recorded more clearly.

◇ Rotate the mode dial to select .

Select the menu. (→ 28)

[ADVANCED] → [ZOOM MIC] → [ON]

Recording yourself

◇ Rotate the mode dial to select  or .

Rotate the LCD monitor towards the lens side.

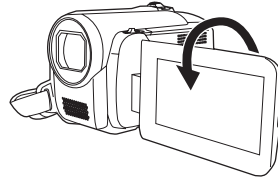



- The image is horizontally flipped as if you see a mirror image. (However the image recorded is the same as a normal recording.)
- When the LCD monitor is rotated towards the lens side, the icon will not be displayed even if you press the joystick.
- Only some indications will appear on the screen. When [] appears, return the direction of the LCD monitor to normal position and check the warning/alarm indication. (→ 99)

Quick start

This unit will resume recording/pause mode about 1.7 seconds after the LCD monitor is reopened.

- When in quick start standby mode about 60% of the power used in recording pause mode is being consumed, so the recording time will be reduced.

◇ Rotate the mode dial to select  or .

1 Select the menu. (→ 28)

[SETUP] → [QUICK START] → [ON]

2 Close the LCD monitor while the mode dial is set to or .

The status indicator  flashes green and the unit goes into quick start standby mode.

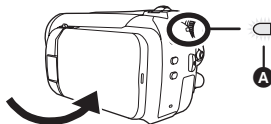

3 Open the LCD monitor.

The status indicator  lights red and the unit is put into recording pause approx. 1.7 seconds after it is turned on.



To cancel Quick start

Select [SETUP] → [QUICK START] → [OFF]

- The default setting is on.
- Quick start standby mode is canceled if
 - about 5 minutes elapsed
 - the mode dial is switched
 - the battery is removed or the AC adaptor is disconnected
- In the quick start mode it may take some time for automatic white balance to adjust, if the scene being recorded has a light source

different from the scene last recorded. (When the MagicPix function is used, however, the white balance of the scene last recorded is retained.)

- In the quick start mode, the zoom magnification becomes 2× and the picture size may differ from what it was before quick start standby mode.
- If [POWER SAVE] (→ 29) is set to [5 MINUTES] and the unit automatically goes into quick start standby mode, close the LCD monitor and then open it again.

Image stabilizer function

Reduces the image shaking (jitter) due to hand movement when recording.

◇ Rotate the mode dial to select  or .

Press the O.I.S. button.

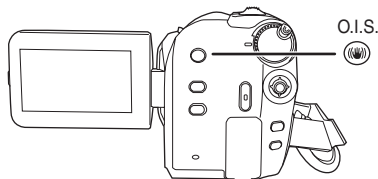

The image stabilizer icon [] appears.

To cancel the image stabilizer function

Press the O.I.S. button again.

- The default setting is on.
- In the following cases, the image stabilizer function may not work effectively.
 - When the digital zoom is used
 - When the unit is shaken greatly
 - When you record a moving subject while tracking it

Recording functions of operation icons

HDD SD

Set the recording functions by selecting the operation icons to add different effects to the recorded images.

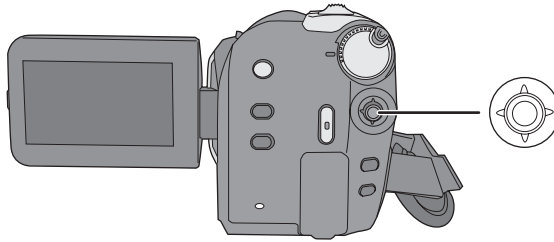

◇ Rotate the mode dial to select  or .

1 Press the joystick, and icons will be displayed on the screen.



- The indication changes each time the joystick is moved down.
- The indication disappears when the center of the joystick is pressed again.

2 Select an icon with the joystick.







To cancel the function

Select the icon again.

Operation icons

Backlight compensation/Fade/Help mode/MagicPix/Soft skin mode/Self-timer











📹 Video recording mode

	<p> Backlight compensation</p> 	<p> Fade</p> 	<p> Help mode</p> 
	<p> MagicPix</p> 	<p> Soft skin mode</p> 	









- The shaded operation icons are not displayed while recording.

- If you turn off the power or operate the mode dial, the backlight compensation and the MagicPix functions are canceled.
- If you turn off the power, the fade function is canceled.

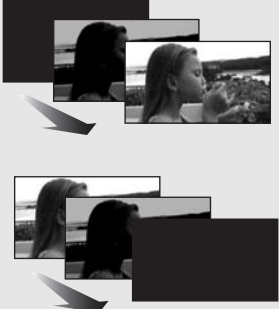
📷 Picture recording mode

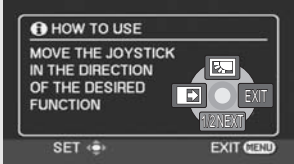
	<p> Backlight compensation</p> 	<p> Self-timer</p> 	<p> Help mode</p> 
	<p> Soft skin mode</p> 		

- If you turn off the power or operate the mode dial, the backlight compensation function is canceled.
- If you turn off the power, the self-timer function is canceled.

Function	Effect
 Backlight compensation	<p>This makes the image brighter to prevent darkening of a backlit subject.</p>
 Fade 	<p>When you start recording, the image/audio gradually appears. (Fade in) When you pause recording, the image/audio gradually disappears. (Fade out)</p> <ul style="list-style-type: none"> After the image/audio completely disappears, the recording stops and the fade setting is canceled. <p>■ To select the color for fade in/out Select the menu. (→ 28) [ADVANCED] → [FADE COLOR] → [WHITE] or [BLACK]</p>
 Help mode 	<p>This explains the recording functions. (Only for icons that can be selected in auto mode) Select the desired icon with the joystick to display an explanation on the screen.</p> <hr/> <p><i>To exit the help mode</i> Press the MENU button or select [EXIT].</p>
 MagicPix	<p>This allows you to record color subjects in dark locations to stand out against the background.</p> <ul style="list-style-type: none"> Minimum required illumination: approx. 2 lx Attach this unit to a tripod, and you can record images free from vibration. If it is difficult to focus, adjust the focus manually. (→ 50)
 Soft skin mode	<p>This makes skin colors appear softer for a more attractive appearance. This is more effective if you record a person closely from the torso up.</p>
 Self-timer	<p>This is for recording still pictures using the timer. Use this function to include yourself in the picture. Press the recording start/stop button, the [⌚] indication blinks for about 10 seconds and then the still picture is recorded.</p> <ul style="list-style-type: none"> After recording, the self-timer is canceled. <hr/> <p><i>To stop the timer midway through</i> Press the MENU button. (The self-timer setting is canceled.)</p>

 **Fade:**

- The thumbnails of scenes recorded using fade in become black (or white).

 **Help mode:**

- When the help mode is used, functions cannot be set.
- When the help mode is used, motion pictures and still pictures cannot be recorded.

 **MagicPix:**

- Recorded scene is seen as if frames were missed.
- The MagicPix function makes the signal charging time of CCD up to approximately 30× longer than usual, so that dark scenes can be recorded brightly. For this reason, bright dots that are usually invisible may be seen, but this is not a malfunction.
- If set in a bright place, the screen may become washed out for a while.

 **Soft skin mode:**

- If the background or anything else in the scene has colors similar to the skin color, they will also be smoothed.
- If the brightness is insufficient, the effect may not be clear.
- You may not be able to see the face clearly when recording a distant person. In this case, cancel soft skin mode or zoom in on the face.



Recording functions of menus

HDD SD

Menus

Guideline/Aspect ratio/Wind noise reduction/Auto slow shutter

◇ Rotate the mode dial to select  or .

Function	Effect/Setting method
Guideline function	You can check if the image is level while recording by using the guidelines displayed on the screen. Select the menu. (→ 28) [BASIC] → [GUIDE LINES] → [ON] • To cancel the function, select [OFF].
Aspect ratio (Only when the mode dial is set to  .)	This allows you to record images compatible with wide-screen TVs (16:9) and regular TVs (4:3). Select the menu. (→ 28) [BASIC] → [ASPECT] → [16:9] or [4:3] • The default setting is [16:9].
Wind noise reduction function (Only when the mode dial is set to  .)	This reduces the winding noise picked up by the microphone. Select the menu. (→ 28) [ADVANCED] → [WIND CUT] → [ON] • The default setting is [ON]. • To cancel the function, select [OFF].
Auto slow shutter mode	You can record bright pictures even in dark places by slowing the shutter speed. Select the menu. (→ 28) [ADVANCED] → [AUTO SLW SHTR] → [ON] • The default setting is [ON]. • To cancel the function, select [OFF].

Guideline function:

- The guidelines do not appear on the images actually recorded.
- The guidelines are not displayed while rotating the LCD monitor frontward to record yourself.

Wind noise reduction function:

- The wind noise reduction depends on the wind strength. (If this function is activated in strong winds, the stereo effect may be reduced. When the wind weakens, the stereo effect will be restored.)

Auto slow shutter mode:

- When the auto slow shutter mode is selected, the slowest shutter speed changes from 1/60 to 1/30.
- When the shutter speed becomes 1/30, the screen display may be seen as if frames are missed and afterimages may appear.
- If the scene is low in brightness or contrast, the subject may not be focused on.

HDD SD

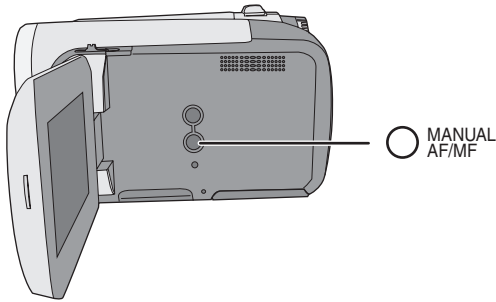

1



2



Each time you press the MANUAL AF/MF button:

1 Manual mode

The icon shown in the illustration appears.

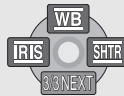

WB White balance

IRIS Aperture adjustment

SHTR Shutter speed

2 Manual focus mode

The manual focus indication [MF] and the icon shown in the illustration appear.



MF \mp Manual focus adjustment

◇ Rotate the mode dial to select  or .

Press the MANUAL AF/MF button.





Scene mode

When you record images in different situations, this mode automatically sets optimum shutter speeds and apertures.

1 Select the manual mode. (→ 48)

2 Select the menu. (→ 28)

[BASIC] → [SCENE MODE] → desired setting

Icon	Mode/Recording conditions
	Sports To record sports scenes or scenes where there are quick motions
	Portrait To make people stand out against the background
	Low light To make the scene brighter in dark conditions
	Spotlight To make the subject under a spotlight look more attractive
	Surf & snow To record images in bright places such as ski slopes and beaches

To cancel the scene mode function

Set [SCENE MODE] to [OFF].

- You can also cancel the scene mode function by pressing the AUTO button.

Sports mode

- For slow-motion playback or playback pause of recorded pictures, this mode helps diminish camera shake.
- During normal playback, the image movement may not look smooth.
- Avoid recording under fluorescent light, mercury light or sodium light because the color and brightness of the playback image may change.

- If you record a subject illuminated with bright light or a highly reflective subject, vertical lines of light may appear.

- If the brightness is insufficient, the sports mode does not function. The [] display flashes.

- If this mode is used indoors, the screen may flicker.

Portrait mode

- If this mode is used indoors, the screen may flicker. If so, change the scene mode setting to [OFF].

Low light mode

- Extremely dark scenes may not be able to be recorded finely.

Spotlight mode

- If the recording subject is extremely bright, the subject may become washed out and the periphery extremely darkened.

Surf & snow mode

- If the subject is extremely bright, the recorded image may become washed out.

Manual focus adjustment

If auto focusing is difficult due to the conditions, then use manual focus.

- 1 Select the manual focus mode. (→ 48)

- 2 Bring the subject into focus with the joystick.



To restore to the automatic adjustment

Press the MANUAL AF/MF button again.

- You can also restore the auto focusing by pressing the AUTO button.

White balance

The automatic white balance function may not reproduce natural colors depending on the scenes or lighting conditions. If so, you can adjust the white balance manually.

- 1 Select the manual mode. (→ 48)

- 2 Select [WB] with the joystick.



- 3 Select the white balance mode with the joystick.



Icon	Mode/Recording conditions
	Auto white balance adjustment
	Indoor mode (for recording under incandescent lamps) Incandescent lights, halogen lamps
	Outdoor mode Outdoors under a clear sky
	Manual adjustment mode <ul style="list-style-type: none"> • Mercury-vapor lamps, sodium lamps, some fluorescent lights • Lights used for wedding receptions at hotels, stage spotlights in theaters • Sunrise, sunset, etc.

To restore to the automatic adjustment

Set the white balance mode to [AWB].

- You can also restore the automatic adjustment by pressing the AUTO button.

To set the white balance manually

- 1 Select [WB] with the joystick, and fill the screen with a white subject.

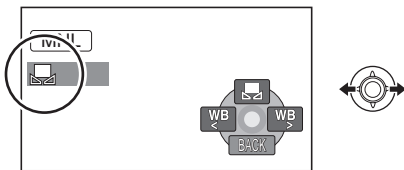

- 2 Select [MNL] with the joystick.

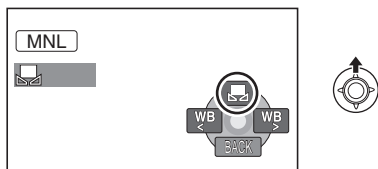

When the [WB] display stops flashing, the setting is complete.

- If the [WB] display continues flashing, the white balance cannot be set because it is too dark. In this case, use the automatic white balance.

■ White balance sensor **A**

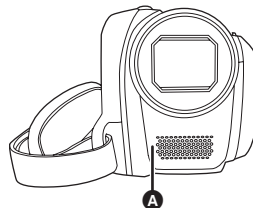

The white balance sensor detects the type of light source during recording.

Do not cover the white balance sensor during recording, or it may not function properly.

- When the unit is turned on with the lens cover closed, the automatic white balance adjustment may not function properly. Please turn the unit on after opening the lens cover.
- When the [WB] display flashes, the manual white balance previously adjusted is stored. Whenever recording conditions change, re-set the white balance for correct adjustment.
- When setting both the white balance and the iris/gain, set the white balance first.

Manual shutter speed/ aperture adjustment

SHTR Shutter Speed:

Adjust it when recording fast-moving subjects.

IRIS Aperture:

Adjust it when the screen is too bright or too dark.

1 Select the manual mode. (→ 48)

2 Select **[IRIS]** or **[SHTR]** with the joystick.



3 Adjust the settings with the joystick.

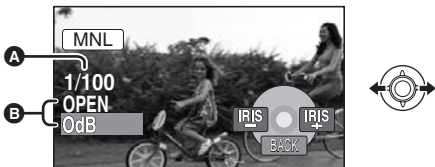

A Shutter speed:

 1/30 to 1/8000

 1/30 to 1/500

- The shutter speed closer to 1/8000 is faster.
- If [AUTO SLW SHTR] is set to [OFF], the slowest shutter speed is 1/60.

B Iris/Gain value:

CLOSE → (F16 to F2.0) → OPEN →
(0dB to 18dB)

- Value closer to [CLOSE] darkens the image.
- Value closer to [18dB] brightens the image.
- When the iris value is adjusted to brighter than [OPEN], it changes to the gain value.

- When setting both the shutter speed and the iris/gain value, set the shutter speed and then set the iris/gain value.

■ Manual shutter speed adjustment

- Avoid recording under fluorescent light, mercury light or sodium light because the color and brightness of the playback image may change.
- If you increase the shutter speed manually, the noise on the screen may increase.
- You may see vertical lines of light in the playback image of a brightly shining subject or highly reflective subject, but this is not a malfunction.
- During normal playback, image movement may not look smooth.
- When recording in an extremely bright place, the screen may change color or flicker. If so adjust the shutter speed manually to [1/60] or [1/100].

■ Manual iris/gain adjustment

- If the gain value is increased, the noise on the screen increases.
- Depending on the zoom magnification, there are iris values that are not displayed.

To restore to automatic adjustment

Press the AUTO button.

Preparation

Recording

Playback

With a PC

Others

- 54** Playback
- 59** Editing
- 71** Media management
- 72** With other products

HDD SD

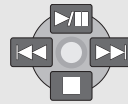
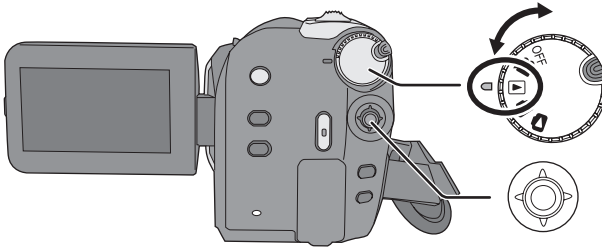

- ▶/||: Playback/Pause
- ◀◀: Skip playback (backward)
- ▶▶: Skip playback (forward)
- : Stops the playback and shows the thumbnails.

1 Rotate the mode dial to select

2 Select the playback medium by the menu. (→ 28)

[MEDIA SELECT] → [HDD] or [SD CARD]

3 Select the scene to be played back, then press the joystick.

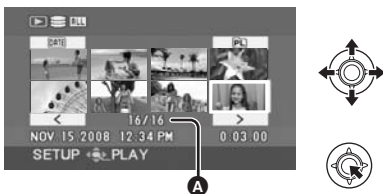

A Scene number (Page number: When /[] is selected.)

The selected scene is played back, and the operation icon is automatically displayed on the screen.

4 Select the playback operation with the joystick.



Selecting pages

- Select []/[] and then press the joystick.
- If you move and hold the joystick left or right, you can fast forward or fast rewind the pages. The screen will not change at this time, but the scene or page numbers will change. Release the joystick when you have arrived at the page with the scene you want to display.

- Sound will be heard only during normal playback.
- When the amount of time recorded on the scene is too short, playback may not be possible.
- When a scene is displayed as [(!)] on the thumbnail display, playback is not possible.
- When set to the video playback mode, the power will not turn off even when the LCD monitor is closed.
- When playing back motion pictures recorded on an SD card with other products on this unit or playing back motion pictures recorded on an SD card with this unit on other products, the picture quality may deteriorate and it may be unplayable. (The message "CANNOT PLAY." appears.)
- The time displayed may be different from the recording time and it may take time to display the thumbnail display when playing back motion pictures recorded on an SD card with other products.
- The recording time is not displayed on the screen during playback of scenes recorded on an SD card with other products.

To change the playback speed

- Normal playback is restored when you move the joystick up.

■ Fast forward/rewind playback

Move and hold the joystick left or right during playback until fast forward/rewind starts.

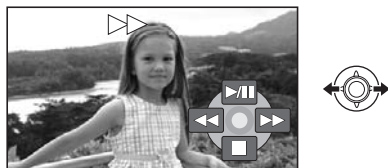

- Move the joystick again to increase the speed.

■ Slow-motion playback

1 Pause the playback.

2 Move and hold the joystick left or right.

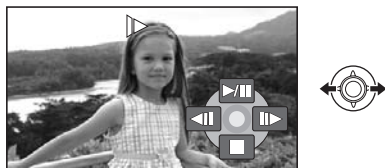

■ Frame-by-frame playback

1 Pause the playback.

2 Move the joystick left or right.

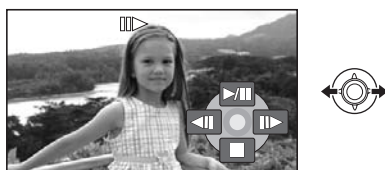

To adjust the speaker volume during playback

Move the volume lever.

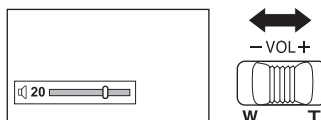

Towards "+": increases the volume

Towards "-": decreases the volume

Resuming the previous playback

Select the menu. (→ 28)

[SETUP] → [RESUME PLAY] → [ON]

If playback of a motion picture is stopped, [R] appears on the thumbnail view of the stopped scene.

To cancel the resume function

Set [RESUME PLAY] to [OFF].

- The memorized resume position is cleared if you edit the scenes, etc.

Playing back motion pictures by date

Scenes recorded on the same day can be played back in succession.

- 1 Select **[DATE]** (BY DATE), then press the joystick.

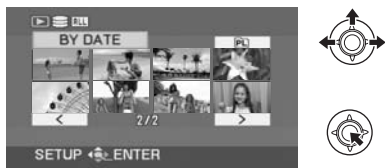

- 2 Select the playback date, then press the joystick.

(When playing back motion pictures on the HDD)

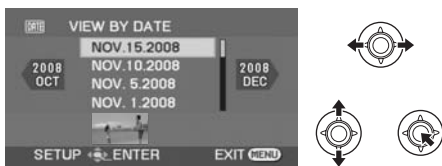

(When playing back motion pictures on the SD card)

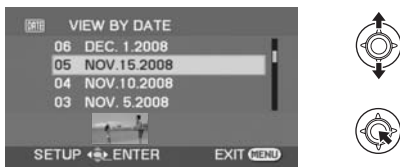

- 3 Select the scene to be played back, then press the joystick.

To select a different date

Select **[DATE]** (BY DATE), then press the joystick.

To return to the screen showing all scenes

Select **[ALL]** (VIEW ALL), then press the joystick.

- Even if scenes are recorded on the same day, they are grouped separately when the number of scenes exceeds 99.

Playing back a playlist

Creating a new playlist (→ 64)

HDD

- 1 Select **[PL]** (PLAYLIST), then press the joystick.

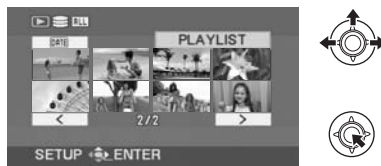

- 2 Select the playlist to be played back, then press the joystick.



- 3 Select the scene to start playback, then press the joystick.

To select a different playlist

Select **[PL]** (PLAYLIST), then press the joystick.

To return to the screen showing the original scenes

Select **[ALL]** (VIEW ALL), then press the joystick.

HDD SD

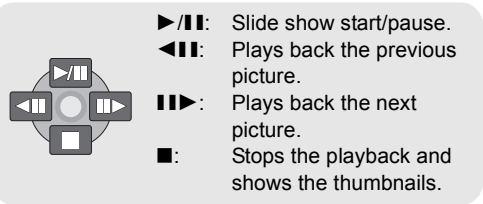
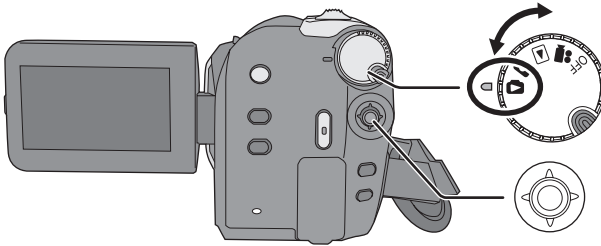

1 Rotate the mode dial to select

The selected file is played back, and the operation icon is automatically displayed on the screen.

2 Select the playback medium by the menu. (→ 28)

[MEDIA SELECT] → [HDD] or [SD CARD]

3 Select the file to be played back, then press the joystick.



4 Select the playback operation with the joystick.

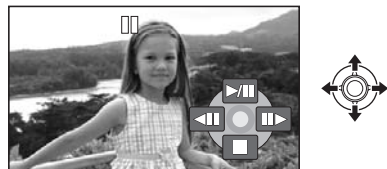

- A** File number (Page number: When []/) is selected.)
- The method for selecting pages is the same as for motion picture playback. (→ 54)

■ About still picture compatibility

- This unit is compliant with the unified standard DCF (Design rule for Camera File system) established by JEITA (Japan Electronics and Information Technology Industries Association).
- The file format supported by this unit is JPEG. (Not all JPEG formatted files will be played back.)
- If a non-standard file is played back, the folder/file number may not be displayed.
- This unit may degrade or not play back data recorded or created on another product and another product may degrade or not play back data recorded on this unit.

-
- While this unit accesses the SD card (the SD card access lamp is lit), do not open the SD card slot cover and remove the SD card.
 - Do not operate the mode dial during the slide show.
 - It takes time to display the file, and how long it will take depends on the number of pixels of the file.
 - When a file is displayed as [[!]] on the thumbnail display, playback is not possible.
 - The time displayed may be different from the recording time and it may take time to display the thumbnail display when playing back still pictures recorded on an SD card with other products.
 - When set to the picture playback mode, the power will not turn off even when the LCD monitor is closed.

HDD SD

Important:

The deleted scenes/files cannot be restored.

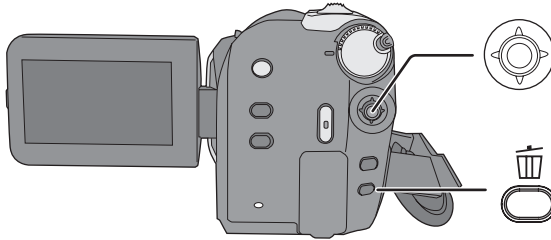

◇ Deleting motion picture scenes:
Rotate the mode dial to select .

◇ Deleting still picture files:
Rotate the mode dial to select .

◇ **Select [HDD] or [SD CARD] in [MEDIA SELECT].**

- To delete an unwanted part of a scene, use the SPLIT&DELETE function. (→ 62)

Deleting scenes/files one at a time

1 Press the  button during playback.

2 When the confirmation message appears **Select [YES], then press the joystick.**

Deleting multiple scenes/files

1 Press the  button in the thumbnail display.

2 Select [SELECT] or [ALL] and press the joystick.

(Only when [ALL] is selected)

- All the scenes/files on the HDD or SD card except the locked scenes/files will be deleted. Proceed to step 5.
- When the date is selected in motion picture playback, all scenes on the selected date are deleted.

3 (Only when [SELECT] is selected in step 2) **Select the scene/file to be deleted, then press the joystick.**

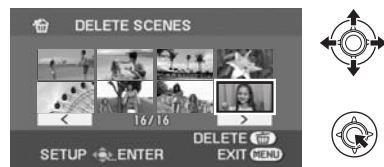

The selected scene/file is encircled by a red frame.

- To unselect the scene/file, press the joystick again.
- Up to 50 scenes/files can be selected to be deleted.

4 (Only when [SELECT] is selected in step 2)
Press the  button.

5 When the confirmation message appears
Select [YES], then press the joystick.

(Only when [SELECT] is selected in step 2)
To continue deleting other scenes/files
 Repeat steps 3 to 5.

To complete editing

Press the MENU button.

- You can also delete scenes/files by the menu. Select [EDIT SCENE] or [PICT. SETUP] → [DELETE].
- In case of [ALL], the deletion may take time if there are many scenes/files.

Deleting the copied scenes collectively

Scenes copied to a disc using the DVD burner or the supplied software (DVD COPY function) can be deleted as a group.

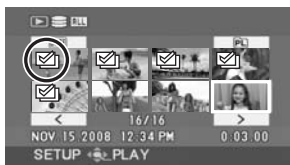

Copied icon () is indicated in the thumbnail display after copying. (→ 75, 93)

1 Select the menu. (→ 28)

[EDIT SCENE] → [DELETE] →
 [COPIED]

2 When the confirmation message appears
Select [YES], then press the joystick.

- The locked scenes or scenes of which copied information was destroyed cannot be deleted.

■ Notes for deleting scenes/files

- Do not turn off this unit while deleting.
- When you delete scenes/files, use a battery with sufficient battery power or use the AC adaptor.
- Do not open the SD card slot cover and remove the SD card while deleting scenes/files recorded on an SD card. The deletion will stop.
- If files conforming to DCF standard are deleted, all the data related to the files will be deleted.
- When deleting still picture files recorded on an SD card by other products, a still picture file (other than JPEG) that cannot be played back on this unit may be erased.
- When a still picture is copied to an SD card using a PC and other equipment, it may not show up on the display of the unit. In this case, the image will not be deleted.

- ◇ Rotate the mode dial to select .

Function	Operating method
<p>Locking motion pictures HDD SD</p> <p>This is for preventing motion picture scenes from being deleted by mistake. (However, please be aware that if a medium is formatted, then all the data on the medium will be erased.)</p>	<p>◇ Select [HDD] or [SD CARD] in [MEDIA SELECT].</p> <ol style="list-style-type: none"> 1 Select the menu. (→ 28) [EDIT SCENE] → [LOCK SET] → [YES] 2 Select the scene to be protected, then press the joystick. <div style="text-align: center;">  </div> <p>[On] appears and the selected scene is locked.</p> <ul style="list-style-type: none"> ● Press the joystick again to release the lock setting. ● You can also select multiple scenes in succession. <hr/> <p>To complete the settings Press the MENU button.</p>

Dividing a scene to delete

HDD

This divides the recorded scenes in two and deletes the front half or back half.

◇ Select [HDD] in [MEDIA SELECT].

- 1 Select the menu. (→ 28)
[EDIT SCENE] → [SPLIT&DELETE] → [YES]
- 2 Select the scene to be divided, then press the joystick.



- 3 When you reach the point where you want to divide the scene
Select [**>x**] with the joystick.

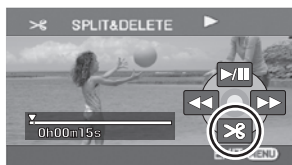

- Move the joystick left or right to fast forward/rewind playback.
- Using slow-motion playback or frame-by-frame playback makes it easy to search for the point where you want to divide the scene. (→ 55)

- 4 Select the half that you want to delete and press the joystick.

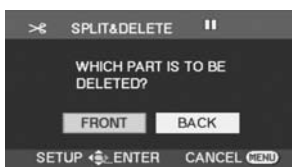

Continued on next page.

Dividing a scene to delete
(Continued)

5 Select [YES], then press the joystick to play back the part to be deleted.

- When [NO] is selected, the confirmation message appears. Proceed to step 6.



When you stop the playback, the confirmation message appears.

6 Select [YES], then press the joystick.

To continue dividing and deleting other scenes

Repeat steps 2 to 6.

To complete editing

Press the MENU button.

- It is impossible to divide and delete scenes with a short recording time. The length of the remaining scenes must be 3 seconds or longer.
- It is impossible to set the dividing point at the beginning or the end of the scene.
- When scenes that have been divided and deleted are copied to a DVD disc using the DVD burner, an error of about 1 second may occur in the images at the point of the division.
- If a scene with  (copied icon) is divided and deleted, the copied information is erased. (→ 75)
- The actual division may slightly slip off the previously designated dividing point.

HDD

You can create a playlist by gathering your favorite recorded scenes.

Since the playlist is not created by copying data, playlists consume a very small amount of HDD space.

- When you create or delete playlists, the original scenes will not be modified. Editing scenes on a playlist will not affect the original scenes.

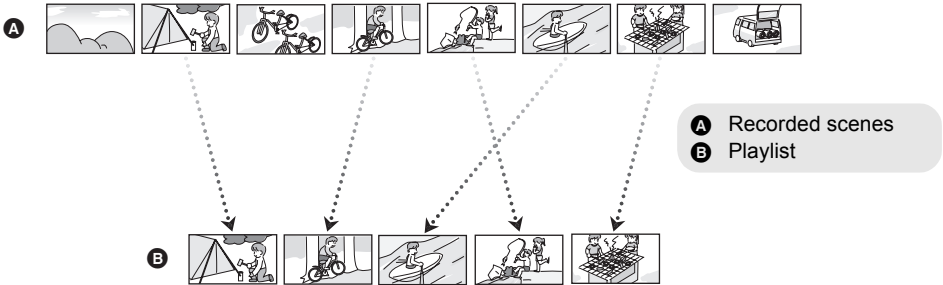

- You can create a playlist on the HDD only. You cannot create a playlist on an SD card.
- The maximum number of playlists on the HDD: 4
The maximum number of playlist scenes on the HDD: 99
- If original scenes are deleted, the portion of playlists created with these scenes is also deleted.

Creating a new playlist

◇ Rotate the mode dial to select .

◇ Select [HDD] in [MEDIA SELECT].

1 Select  (PLAYLIST), then press the joystick.

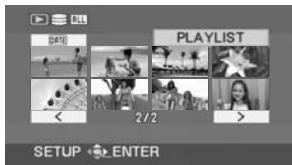

2 Select [CREATE], then press the joystick.



3 Select the scene to be added to the playlist, then press the joystick.

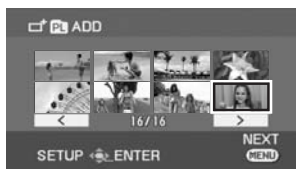

The selected scene is encircled by a red frame.

- To unselect the scene, press the joystick again.
- Up to 50 scenes can be selected and added.
- The scenes are registered in the playlist in the order that they were selected.

4 Press the MENU button.

5 When the confirmation message appears Select [YES], then press the joystick.

Editing a playlist

Editing scenes on a playlist will not affect the original scenes.

◇ Rotate the mode dial to select .

◇ Select [HDD] in [MEDIA SELECT].

1 Select  (PLAYLIST), then press the joystick.

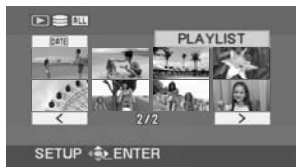

2 Select the playlist to be edited, then press the joystick.



Function

Operating method

Deleting scenes

The method for deleting playlist scenes is the same as for “Deleting scenes/files”. (→ 59)

- If you delete scenes on a playlist, it will not affect the original scenes.
- When [ALL] is selected, the selected playlist will be deleted.
- You can also delete playlist scenes by the menu. Select [EDIT] → [DELETE].
- Deleting scenes on a playlist will not increase the remaining capacity for recording.
- The playlist itself is deleted if you delete all the scenes in it.
- When a playlist is deleted, the number of each subsequent playlist decreases by one.

Adding scenes to playlist

Scenes can be added to the created playlist.

Select the menu. (→ 28)

[EDIT] → [ADD] → [YES]

The following steps are the same as steps 3 to 5 in "Creating a new playlist". (→ 64)

Moving scenes within a playlist

It is possible to change the sequence of scenes in the playlist by moving them to another position.

1 Select the menu. (→ 28)

[EDIT] → [MOVE] → [YES]

2 Select the scene to be moved, then press the joystick.



The selected scene is encircled by a red frame, and the position to insert is shown by a yellow bar.

3 Select the position to insert the scene, then press the joystick.

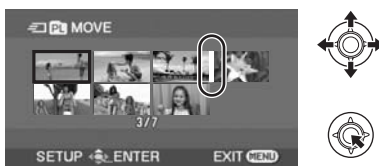



To continue moving other scenes in the playlist

Repeat steps 2 to 3.

To complete editing

Press the MENU button.

- ◇ Rotate the mode dial to select .

Function	Operating method
<p>Locking still pictures HDD SD</p> <p>This is for preventing still picture files from being deleted by mistake. (However, please be aware that if a medium is formatted, then all the data on the medium will be erased.)</p>	<p>◇ Select [HDD] or [SD CARD] in [MEDIA SELECT].</p> <ol style="list-style-type: none"> 1 Select the menu. (→ 28) [PIC. SETUP] → [LOCK SET] → [YES] 2 Select the file to be protected, then press the joystick. <div style="text-align: center;">    </div> <p>[On] appears and the selected file is locked.</p> <ul style="list-style-type: none"> ● Press the joystick again to release the lock setting. ● You can also select multiple files in succession. <hr/> <p>To complete the settings Press the MENU button.</p>

DPOF setting

SD

This is for writing the print data on selected still pictures.

■ What is DPOF?

DPOF (Digital Print Order Format) is a format which allows the user of a digital camera to define which captured images on the SD card are to be printed, together with information on the number of copies they wish to print. (Please note: Not all commercial printing services support this feature at this time.)

◇ Select [SD CARD] in [MEDIA SELECT].

1 Select the menu. (→ 28)

[PICT. SETUP] → [DPOF SET] → [SET]

2 Select the file to be set, then press the joystick.

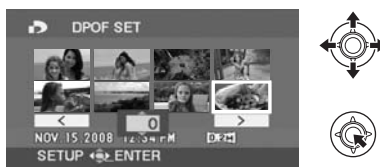

3 Select the number of prints, then press the joystick.

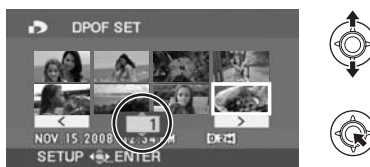

- To cancel the setting, set the number of prints to [0].
- You can also select multiple files in succession.

To complete the settings

Press the MENU button.

To cancel all DPOF settings

Select [PICT. SETUP] → [DPOF SET] → [CANCEL ALL].

- The DPOF setting can be established for up to 999 files.
- DPOF setting made on other devices may not be recognized by this unit. Please perform the DPOF settings on this unit.
- You cannot add the recording date to pictures to be printed with the DPOF settings.

Copying still picture files

HDD **SD**

This is for copying still picture files from the HDD to an SD card or vice versa.

- 1** Select the menu. (→ 28)
[PICT. SETUP] → [COPY]
- 2** Select desired direction and press the joystick.
 ☰ → 📁: Copying from the HDD to an SD card
 📁 → ☰: Copying from an SD card to the HDD
- 3** Select [SELECT] or [ALL] then press the joystick.
 - When [ALL] is selected, all still picture files in the HDD or SD card will be copied. Proceed to step 6.
- 4** (Only when [SELECT] is selected in step 3)
Select the file to be copied, then press the joystick.

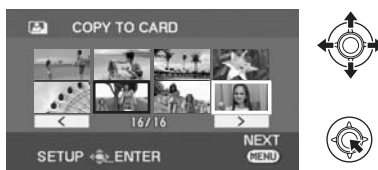

The selected file is encircled by a red frame.

- To unselect the scene, press the joystick again.
- Up to 50 files can be selected to be copied.
- The files are copied in the order that they were selected.

- 5** (Only when [SELECT] is selected in step 3)
Press the MENU button.

- 6** When the confirmation message appears
Select [YES], then press the joystick.

Continued on next page.

Function	Operating method
<p>Copying still picture files (Continued)</p>	<p>(Only when [SELECT] is selected in step 3)</p> <p>To continue copying other files Repeat steps 4 to 6.</p> <p>To cancel copying halfway Press the MENU button.</p> <p>To complete editing Press the MENU button.</p> <hr/> <ul style="list-style-type: none"> ● Do not turn off this unit while copying. ● When you copy files, use a battery with sufficient battery power or use the AC adaptor. ● Do not open the card slot cover while copying. The copying will stop. ● In case of [ALL], the copying may take time if there are many files. ● The copied files are recorded after the still picture files in the copy destination. (The file names or the folder names will differ from the original file.) ● The lock and DPOF settings of the file cannot be copied. ● When a still picture is copied to an SD card using a PC or other equipment, it may not show up on the display of the unit. In this case, the image will not be copied to the HDD even if [ALL] is selected.

HDD and SD card management

Formatting HDD

HDD

This is for initializing HDD.
Please be aware that if the HDD is formatted, then all the data recorded on the HDD will be erased. Store important data on a PC, etc.

- ◇ Rotate the mode dial to select .
- ◇ Select [HDD] in [MEDIA SELECT].

1 Select the menu. (→ 28)

[SETUP] → [FORMAT HDD] → [YES]

2 When the confirmation message appears Select [YES], then press the joystick.

- When formatting is complete, press the MENU button to exit the message screen.
- During formatting, do not turn this unit off.
- When you format the HDD, use a battery with sufficient battery power or the AC adaptor.
- During formatting, do not cause any vibrations or impacts to this unit.

Displaying HDD information

HDD

Information about the space used and remaining on the HDD is displayed.

- ◇ Rotate the mode dial to select .
- ◇ Select [HDD] in [MEDIA SELECT].

Select the menu. (→ 28)

[SETUP] → [INFORMATION] → [YES]

To exit the information screen

Press the MENU button.

- The unit indicating the capacity of the used and usable area is 1 GB=1,073,741,824 bytes.
- The 40 GB hard drive utilizes a portion of the storage space for formatting, file management and other purposes. 40 GB is 40,000,000,000 bytes. Usable capacity will be less.

Formatting an SD card

SD

This is for initializing SD cards.
Please be aware that if an SD card is formatted, then all the data recorded on the card will be erased. Store important data on a PC, etc.

- ◇ Select [SD CARD] in [MEDIA SELECT].

1 Select the menu. (→ 28)

[SETUP] → [FORMAT CARD] → [YES]

2 When the confirmation message appears Select [YES], then press the joystick.

- When formatting is complete, press the MENU button to exit the message screen.
- During formatting, do not turn this unit off.
- Do not open the card slot cover while formatting. The formatting will stop.
- When you format the SD card, use a battery with sufficient battery power or the AC adaptor.
- Use this unit to format SD cards. If an SD card is formatted on other products (such as a PC), the time spent for recording may become longer and you may not be able to use the SD card.
- Depending on the type of SD card being used, it may take time to format.

1

Playback on TV

HDD SD

The motion pictures and still pictures recorded by this unit can be played back on a TV.

- Use the AC adaptor to free you from worrying about the battery running down.
- If you have a TV with an SD card slot, the motion pictures and still pictures recorded on an SD card may be played back on the TV. (Refer to the operating instructions of the TV for details about TV compatibility.)

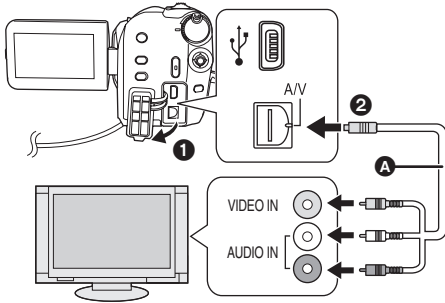

A AV cable (supplied)

- Insert the plugs as far as they will go.
- Do not use any other AV cables except the supplied one.
- Select the video input on the TV that this unit is connected to.

■ **If the image or audio from this unit does not appear on the TV**

- Check the connections.
- Check that the plugs are inserted as far as they go.
- **Check the TV's input setting (input switch).** (For more information, please read the operating instructions for the TV.)

■ **To watch images with a 16:9 aspect ratio on a regular TV (4:3)**

If the images are squeezed horizontally on a TV with a 4:3 aspect ratio, change the menu setting to play back the pictures in the original aspect ratio.

- If the images are not displayed correctly on a wide-screen TV, adjust the aspect setting on the TV. (Refer to the operating instructions of the TV for details.)

Select the menu. (→ 28)

[SETUP] → [TV ASPECT] → [4:3]

1 Connect this unit and a TV.

2 Turn on this unit, then rotate the mode dial to select or .

3 Select the playback medium by the menu. (→ 28)

[MEDIA SELECT] → [HDD] or [SD CARD]

4 Start playback on this unit.

Example of images with a 16:9 aspect ratio on a regular TV (4:3)

[TV ASPECT] setting	
[16:9]	[4:3]

- This function's default setting is [16:9].
- Depending on the TV setting, the pictures may not be displayed correctly. For more information, please read the operating instructions of your TV.

It is possible to copy images that have been recorded on this unit to discs by connecting the optional DVD burner.

The disc that was copied to can be played back by connecting this unit and a DVD burner. (→ 79)

Device capable of copying images to discs by connecting to this unit

– DVD burner/VW-BN1

- We recommend using VW-BN1.
- Operation is not guaranteed with any other DVD drives.
- Use the Mini AB USB Connection Cable supplied with the DVD burner to connect this unit to the DVD burner. (Operation cannot be guaranteed with cables other than the one supplied with the DVD burner.)

About discs that can be used

New*1 12 cm discs (DVD-RAM, DVD-RW*2, DVD-R, DVD-R DL, CD-RW*3, CD-R*3)

- Do not allow fingerprints or dirt to get on the recording/playback side of the disc.
- +RW/+R/+R DL discs or 8 cm discs cannot be used for copying.
- Refer to the operating instructions of the DVD burner for details about recommended discs, disc handling, etc.

*1 You cannot record on a disc that has already been used. However, a formatted DVD-RAM, DVD-RW, or CD-RW disc can be used for copying.

When a recorded DVD-RAM, DVD-RW, or CD-RW disc is inserted into the DVD burner, the disc is formatted and recording starts. **The data recorded on the disc will be erased.** Please be aware that the erased data cannot be restored.

*2 Supports motion pictures only

*3 Supports still pictures only

■ The different copying functions available when this unit is connected to the DVD burner

Data Media	Motion pictures		Still pictures	Page
	HDD	SD	HDD/SD	
DVD COPY function				
① ALL SCENES	●	●	●	75
② ADDED SCENES	●	●	–	75
FAVOURITE SCENES function				
③ SELECT SCENES	●	●	–	76
④ SELECT DATE	●	●	–	77
⑤ SELECT PLAYLIST	●	–	–	77

●: applicable –: not applicable

- It is impossible to copy motion pictures and still pictures simultaneously.
- It is impossible to copy data from the HDD and SD card simultaneously.
- You cannot copy from multiple SD cards to 1 disc.
- The order in which the scenes are copied cannot be changed.

Connecting this unit to the DVD burner

Connect this unit to the DVD burner to copy data to discs or play back motion pictures or still pictures that were copied to a disc.

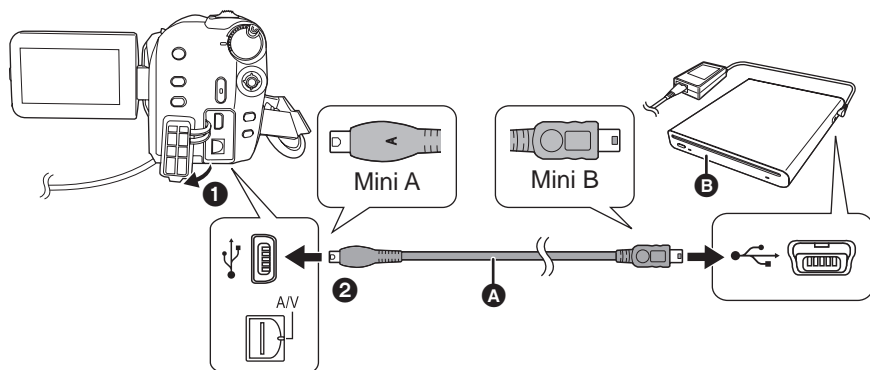

A Mini AB USB Connection Cable (supplied with the DVD burner)

B DVD burner (optional)

- Connect the Mini A terminal to this unit and the Mini B terminal to the DVD burner.
- Insert the plugs as far as they will go.

1 Connect the AC adaptor supplied with the DVD burner to the DVD burner.

- You cannot supply power to the DVD burner from this unit.

2 Connect this unit to the AC adaptor.

- If a battery is used, operation is not possible when this unit is connected to a DVD burner.

3 Turn on the power to this unit.

4 Connect this unit to the DVD burner with the Mini AB USB Connection Cable (supplied with the DVD burner).

- The DVD burner function selection screen will appear.

5 Insert the disc in the DVD burner.

- Insert the disc into the DVD burner after connecting the DVD burner to this unit.

• Please read the operating instructions of the DVD burner for how to use it.

- If the DVD burner is connected to this unit with a disc already inserted, the message "CANNOT CHECK CONNECTED DEVICE. DISCONNECT THE USB CABLE FROM THIS UNIT." may be displayed after "Please Wait." is displayed for over a minute. When this happens, disconnect the Mini AB USB Connection Cable from the unit and remove the disc from the DVD burner to make sure the disc is usable and was not inserted upside down. (→ 73)

DVD COPY function

HDD SD

Images recorded on this unit can be backed up to discs.

Copied information is recorded in the motion picture scenes that are copied to a disc using the DVD COPY function. It is possible to write only scenes that are added after copying or delete the copied scenes as a group.

◇ **Connect this unit to the DVD burner. (→ 74)**

1 Copying all the scenes to discs

Copy all motion pictures or still pictures on any of the media to discs.

1 Select menus with the following procedures.

[BURN DISC] → [HDD] or [SD CARD] →
[VIDEO] or [PICTURE] → [DVD COPY]*
→ [ALL SCENES]*

* Only when [VIDEO] is selected.

2 Copying added scenes to discs

Copy scenes on the media, which are added after being copied to the disc using the DVD COPY function (scenes that the copied icons (☒) are not indicated), to discs.

1 Select menus with the following procedures.

[BURN DISC] → [HDD] or [SD CARD] →
[VIDEO] → [DVD COPY] →
[ADDED SCENES]

2 Select [YES], then press the joystick.

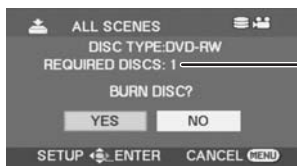

A The number of discs necessary for copying by disc type.

- When 2 or more discs are necessary for copying, follow the on-screen instructions to switch discs.

- When a recorded DVD-RAM, DVD-RW, or CD-RW disc is inserted in the DVD burner, a message confirming whether the contents of the disc can be erased or not is displayed. After confirming that the data can be erased, select [YES].
- When a message appears indicating copying is complete, then press the joystick. If all scenes are copied, it is possible to create another set with the same contents. Follow the instructions on the screen.
To finish, eject the disc and disconnect the Mini AB USB Connection Cable.

- Press the MENU button in the middle of the operation to return to the initial menu screen.

■ Copied icon (☒)

The copied information is recorded in motion picture scenes that are copied to a disc using the DVD COPY function, and ☒ is indicated on the thumbnail.

- Motion picture scenes indicated with ☒ can be deleted as a group using the delete menu. (→ 60)
- The copied information will be deleted when using the SPLIT&DELETE function to split and delete scenes that were copied using the DVD COPY function. Therefore these scenes will be copied again when using the ADDED SCENES function.

FAVOURITE SCENES function

It is possible to select motion picture scenes recorded on this unit and record them on a single DVD disc, as well as copy scenes by selecting the recording date.

It is also possible to copy playlists created on the HDD to DVD discs.

◇ **Connect this unit to the DVD burner. (→ 74)**

3 Selecting the scenes to copy to 1 disc

HDD SD

Select scenes from the recorded motion pictures to copy to a single DVD disc.

1 Select menus with the following procedures.

[BURN DISC] → [HDD] or [SD CARD] → [VIDEO] → [FAVOURITE SCENES] → [SELECT SCENES]

- When a recorded DVD-RAM or DVD-RW disc is inserted in the DVD burner, a message confirming whether the contents of the disc can be erased or not is displayed. After confirming that the data can be erased, select [YES].

2 Select the scenes to be copied and then press the joystick.

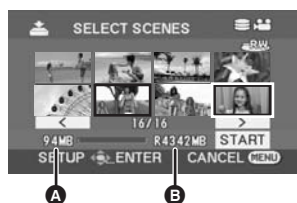

The selected scene is encircled by a red frame.

- To unselect the scene, press the joystick again.
- Up to 50 scenes can be set in succession.
- If the total data size of the scene exceeds the disc capacity, the remaining space on the disc display will turn red and the amount in excess will be displayed. Select scenes so that they fit on to one disc.

* The units of usable capacity on a DVD disc are 1 MB=1,048,576 bytes.

3 When the confirmation message appears Select [START], then press the joystick.

4 Select [YES], then press the joystick.

- When a message appears indicating copying is complete, then press the joystick. It is possible to create another disc with the same contents. Follow the instructions on the screen.
To finish, eject the disc and disconnect the Mini AB USB Connection Cable.

- Press the MENU button in the middle of the operation to return to the initial menu screen.

4 Selecting the scenes by date to copy to discs

HDD SD

Scenes recorded with this unit are selectively copied by date to DVD discs.

1 Select menus with the following procedures.

[BURN DISC] → [HDD] or [SD CARD] → [VIDEO] → [FAVOURITE SCENES] → [SELECT DATE]

- Press the MENU button in the middle of the menu operation to return to the initial menu screen.

5 Selecting the scenes by playlist to copy to discs

HDD

Playlists created on the HDD of this unit are copied to DVD discs.

1 Select menus with the following procedures.

[BURN DISC] → [HDD] → [VIDEO] → [FAVOURITE SCENES] → [SELECT PLAYLIST]

- Press the MENU button in the middle of the menu operation to return to the initial menu screen.

2 Select the date/playlist to be copied and then press the MENU button.

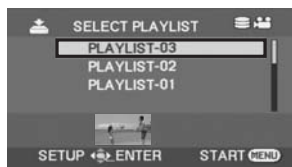

The selected date/playlist is encircled by a red frame.

- To unselect the date/playlist, press the joystick again.
- Up to 50 dates can be set in succession.

3 When the confirmation message appears Select [YES], then press the joystick.

4 Select [YES], then press the joystick.

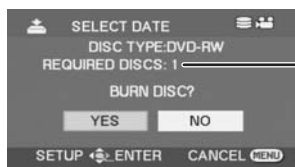

- A** The number of discs necessary for copying by disc type.
- When 2 or more discs are necessary for copying, follow the on-screen instructions to switch discs.

- When a recorded DVD-RAM or DVD-RW disc is inserted in the DVD burner, a message confirming whether the contents of the disc can be erased or not is displayed. After confirming that the data can be erased, select [YES].
- When a message appears indicating copying is complete, then press the joystick. It is possible to create another set with the same contents. Follow the instructions on the screen. To finish, eject the disc and disconnect the Mini AB USB Connection Cable.
- Press the MENU button in the middle of the operation to return to the initial menu screen.

Notes for copying data to discs using the DVD burner

When deleting data on the media after making a copy, be sure to play back the discs to check that they have been copied correctly before deleting. (→ 79)

- Do not turn off this unit or the DVD burner or disconnect the Mini AB USB Connection Cable while copying. Also, do not shake this unit and the DVD burner.
- You cannot connect a USB hub and use it.
- You cannot eject a disc while copying.
- When data is divided and copied to more than one disc, a disc with a large unused area may result since data is recorded by scene.
- After data is copied to a disc, images cannot be added to the disc by connecting the unit to the DVD burner.
- Use of a CD-RW or CD-R disc is recommended for copying still pictures that are small in size.
- If "READING DISC..." is displayed on the screen for more than 2 minutes, remove the disc from the DVD burner and make sure the disc is usable and was not inserted upside down. (→ 73)
- There is no guarantee that a disc created by connecting this unit and the DVD burner will play back on any playable device.
- The recording date for scenes or files copied to a disc using the DVD burner with this unit is the date that the scene or file was copied. This date may not be displayed properly depending on the software used.
- Data that has been recorded on another device may not be copied, or it may not play properly even if it is copied.
- When a still picture file is copied to an SD card using a PC and other equipment but it does not show up on the display of the this unit, the image will not be copied to the disc.

When a disc that was created with this unit and the DVD burner is inserted into the DVD recorder, a message may be displayed prompting you to format the disc. Do not format the disc because all data will be erased and cannot be recovered. Refer to the operating instructions of the DVD recorder for details.

■ About the time it takes to copy

The time it takes to copy differs depending on the number of scenes recorded on the media, type of disc, number of discs copied, and the room temperature. Also, it takes time to automatically verify the copied data. For this reason, it may take longer to copy than the recording time on the medium.

Wait until the message is displayed indicating completion of copying.

- It takes even longer to copy to DVD-R DL disc than other discs because there are two layers of recording surface on one side.

Playing back a disc inserted in the DVD burner

You can play back the motion pictures or the still pictures copied to a disc.

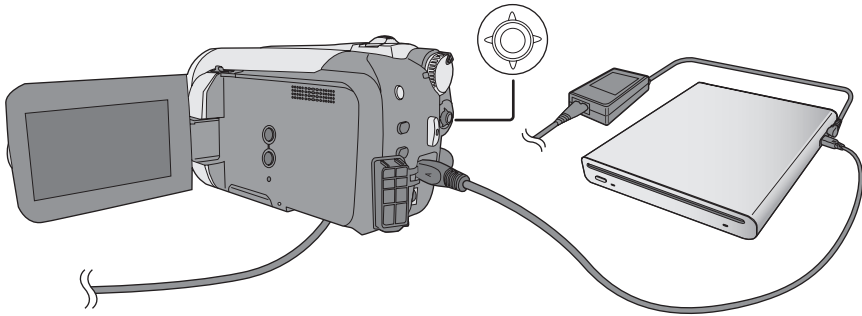

1 Connect this unit to the DVD burner. (→ 74)

2 Select [PLAY DISC], then press the joystick.

- The motion pictures or the still pictures on the disc are displayed as thumbnails.

3 Select the scene/file to be played back, then press the joystick.



4 Select the playback operation with the joystick.

- The playback operation is the same as when playing back motion pictures or still pictures. (→ 54, 57)
- After playback, eject the disc and disconnect the Mini AB USB Connection Cable.

Recording (dubbing) images onto other video devices

HDD SD

You can create a playlist by gathering the scenes on the HDD that you want to record (dub), then record (dub) only the scenes in this playlist to other devices. (→ 64)

- Use the AC adaptor to free you from worrying about the battery running down.

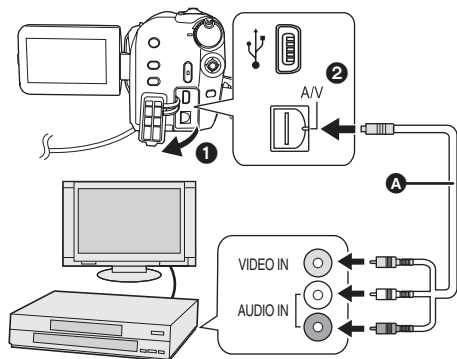

A AV cable (supplied)

- Insert the plugs as far as they will go.
- Do not use any other AV cables except the supplied one.
- Select the video input on the video device and TV that this unit and the video device are connected to.

1 Connect this unit to a video device.

2 Turn on this unit, then rotate the mode dial to select .

3 Select the playback medium by the menu. (→ 28)

[MEDIA SELECT] → [HDD] or [SD CARD]

4 Start playback on this unit. Then start recording on the connected device.

To stop recording (dubbing)

Stop recording on the connected device. Then stop playback on this unit.

■ Using SD card slot of other video devices

If you have a DVD recorder with an SD card slot, images recorded by this unit can be copied (dubbed) onto the hard disk or a DVD disc.

Refer to the operating instructions of your DVD recorder for information about whether or not it supports copying (dubbing) from an SD card.

- For details on how to copy (dub) the images, refer to the operating instructions of the DVD recorder.

If you record (dub) images directly from the SD card or with the AV cable and then play them back on a wide-screen TV, they may be squeezed horizontally. In this case, refer to the operating instructions of the device you are recording (dubbing) to or read the operating instructions of the wide-screen TV and set the aspect setting to 16:9 (Full).

HDD SD

To print pictures by directly connecting this unit to the printer, use a printer compatible with PictBridge. (Read the operating instructions for the printer.)

- Use the AC adaptor to free you from worrying about the battery running down.

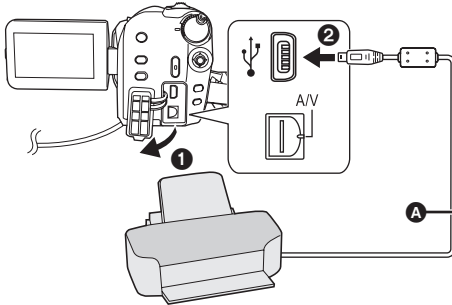

- A** USB cable (supplied)
- Insert the USB connectors as far as they will go.
 - Do not use any other USB connection cables except the supplied one. (Operation is not guaranteed with any other USB cables.)

1 Connect this unit to a printer.
The USB function selection screen will appear.

2 Select [PictBridge] → [HDD] or [SD CARD] then press the joystick.

The [[PictBridge]] indication appears on this unit's screen.

3 Select a file to be printed, then press the joystick.

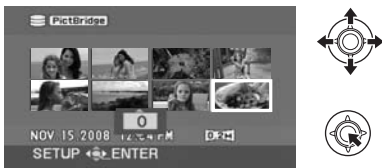

4 Select the desired number of prints, then press the joystick.



- You can set up to 9 prints.
- To cancel the setting, set the number of prints to [0].
- Up to 8 files can be selected to be printed.

5 Press the MENU button to display the PictBridge menus.

6 Select the date print setting on [DATE PRINT], then press the joystick.

- If the printer is not capable of date printing, this setting is unavailable.

7 Select the paper size setting on [PAPER SIZE], then press the joystick.

[STANDARD]: Size specific to the printer

[4x5 INCH]: L size

[5x7 INCH]: 2L size

[4x6 INCH]: Postcard size

[A4]: A4 size

- You cannot set paper sizes not supported on the printer.

8 Select the layout setting on [PAGE LAYOUT], then press the joystick.

[STANDARD]: Layout specific to the printer

[]: No frame print

[]: Frame print

- You cannot set page layouts not supported on the printer.

9 Select [PRINT] → [YES] and press the joystick.

- Exit PictBridge by disconnecting the USB cable after the pictures have been printed.

When you want to stop printing halfway

Move the joystick down.

A confirmation message appears. If [YES] is selected, the number of prints set is canceled and the screen returns to step 3. If [NO] is selected, all the settings are kept and the screen returns to step 3.

-
- Avoid the following operations during printing. These operations disable proper printing.
 - Disconnecting the USB cable
 - Opening the SD card slot cover and removing the SD card
 - Switching the mode dial
 - Turning off the power
 - Check the settings for the paper size, quality of print, etc. on the printer.
 - The sides of pictures recorded in [] mode may be cut off. Check before printing (print preview).

When using a printer with a trimming or borderless printing function, cancel this function before printing. (Refer to the operating instructions of the printer for details.)

- When the unit is connected directly to the printer, the DPOF settings cannot be used.
- Connect the printer directly to this unit. Do not use a USB hub.

Preparation

Recording

Playback

With a PC

Others

- 84** Before using
- 88** Setup
- 92** Using software
- 94** Using a Macintosh

What you can do with a PC

When you have installed VideoCam Suite from the supplied CD-ROM and connected your PC to the unit, you can perform the operations described below.

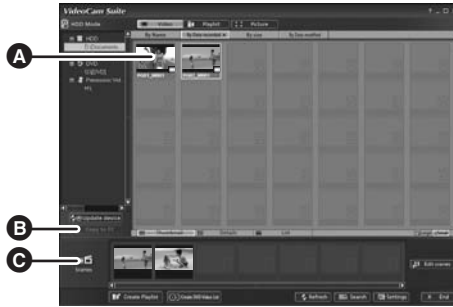

- A** Play back images recorded by this unit on a PC.
- B** Copy images recorded by this unit onto the PC hard disk.
Select the desired images and create original DVD-Video discs.
- C** Edit (split, merge, or delete) images copied to a PC.
Create playlists.

-
- VideoCam Suite can handle images recorded with this unit or by using VideoCam Suite. Images created with other video cameras, DVD recorders, software and commercial DVD-Videos are not supported.
 - We cannot guarantee proper operation of this unit if you use software other than that supplied.
 - Do not copy images recorded on this unit using any software other than the supplied software.

■ Adobe Reader

To view the installed operating instructions, Adobe Reader (Adobe Acrobat Reader) 5.0 or later is required.

If the Adobe Reader (Adobe Acrobat Reader) is not already installed on your PC, you can install it from the CD-ROM. Click the [Adobe Reader] in [Setup Menu], and follow the on-screen messages to install.

- The following system requirements are necessary in order to install Adobe Reader from the supplied CD-ROM.
 - Intel Pentium III or equivalent processor
 - Microsoft Windows 2000 Professional Service Pack 4, Microsoft Windows XP Home Edition Service Pack 2, Microsoft Windows XP Professional Service Pack 2, or Microsoft Windows Vista
 - 128 MB of RAM (256 MB recommended for complex forms or large documents)
 - Microsoft Internet Explorer 6.0 or 7.0, Firefox 1.5 or 2.0, Mozilla 1.7, AOL 9
- If the application cannot be installed under the system requirements listed above, execute Windows Update and then attempt to install the application again.

- A CD-ROM drive is necessary to install the supplied software applications.
- When 2 or more USB devices are connected to a PC, or when devices are connected through USB hubs or by using extension cables, proper operation is not guaranteed.
- Use the supplied USB cable when connecting to the PC. (Operation is not guaranteed with any other USB cables.)

■ VideoCam Suite 1.0

Personal computer	IBM PC/AT compatible personal computer
OS	Microsoft Windows 2000 Professional Service Pack 4 Microsoft Windows XP Home Edition Service Pack 2 Microsoft Windows XP Professional Service Pack 2 Microsoft Windows Vista Home Basic Microsoft Windows Vista Home Premium
CPU	Intel Pentium III 800 MHz or higher (Intel Pentium 4 1.8 GHz or higher recommended)
RAM	Windows Vista: 512 MB or more (1 GB or more recommended) Windows XP/2000: 256 MB or more
Display	High Color (16 bit) or more (32 bit or more recommended) Desktop resolution of 1024×768 pixels or more Video card supporting DirectX 9.0c (supports overlay of DirectDraw)
Free hard disk space	DMA transfer effective at Ultra DMA/33 or more (Ultra DMA/100 or higher recommended) For installing the application: 150 MB or more When creating discs (DVD-Video): 5 GB or more for the work folder (10 GB or more in the case of dual layer discs) <ul style="list-style-type: none"> • If compression setting is enabled, errors may occur during recording. Please uncheck [Compress this drive and clear the disc area] in [Properties] on the hard disk drive.
Necessary software	DirectX 9.0c or later <ul style="list-style-type: none"> • If you install the software on a PC that is not compatible with DirectX 9.0c, the PC may not work properly. If you are unsure whether or not your PC is compatible, contact the maker of your PC. Adobe Acrobat Reader 5.0 or later or Adobe Reader 6.0 or later (required to display the operating instructions) <ul style="list-style-type: none"> • For Windows Vista, use Adobe Reader 8.0 or later.
Disc drive	A drive that supports recording on DVD-R/DVD-RW/DVD-RAM discs
Sound	DirectSound support
Interface	USB port [Hi-Speed USB (USB 2.0) is recommended]
Other requirements	Mouse or equivalent pointing device SD card reader/writer (required to read and write the SD card)

- Even if the system requirements mentioned in these operating instructions are fulfilled, some personal computers cannot be used.
- Supplied CD-ROM is available for Windows only.
- This software is not compatible with Microsoft Windows 3.1, Windows 95, Windows 98/98SE, Windows Me and Windows NT.
- Operation on an upgraded OS is not guaranteed.
- Operation is not guaranteed on computers that are not PC/AT compatible.
- This software is not compatible with a multi-boot environment.
- This software is not compatible with a multi-CPU environment.
- Operation is not guaranteed on Microsoft Windows XP Media Center Edition, Tablet PC Edition, Windows Vista Business/Enterprise and 64 bit operation systems.
- Input is not supported in languages other than English, French and Spanish.
- DirectX 9.0c will be installed automatically during installation of the supplied software.
- Operation cannot be guaranteed on all DVD drives.
- DVD discs authored with this software are not guaranteed to play in all DVD players.
- Depending upon the environment of your PC, if it does not support Hi-Speed USB (USB 2.0), for example, frame dropout may occur, the audio may be intermittent, or the software may run slowly when you play back recorded images.
- If your PC does not satisfy the above system requirements, an error may occur when writing data to disc.

■ SD card reader function (mass storage)

Personal computer	IBM PC/AT compatible personal computer
OS	Microsoft Windows 2000 Professional Service Pack 4 Microsoft Windows XP Home Edition Microsoft Windows XP Professional Microsoft Windows Vista Home Basic Microsoft Windows Vista Home Premium
CPU	Windows Vista: Intel Pentium III 1.0 GHz or higher Windows XP/2000: Intel Pentium II 300 MHz or higher
RAM	Windows Vista Home Basic: 512 MB or more Windows Vista Home Premium: 1 GB or more Windows XP/2000: 32 MB or more (64 MB or more recommended)
Interface	USB port

- The USB equipment operates with the driver installed as standard in the OS.

End User License Agreement

Before opening the CD-ROM package, please read the following.

You ("Licensee") are granted a license for the Software defined in this End User Software Agreement ("Agreement") on condition that you agree to the terms and conditions of this Agreement. If Licensee does not agree to the terms and conditions of this Agreement, promptly return the Software to Matsushita Electric Industrial Co., Ltd. ("Matsushita"), its distributors or dealers from which you made the purchase.

Article 1 License

Licensee is granted the right to use the software, including the information recorded or described on the CD-ROM, instruction manuals, and any other media provided to Licensee (collectively "Software"), but all applicable rights to patents, copyrights, trademarks and trade secrets in the Software are not transferred to Licensee.

Article 2 Use by a Third Party

Licensee may not use, copy, modify, transfer or allow any third party, whether free of charge or not, to use, copy or modify the Software, except as expressly provided for in this Agreement.

Article 3 Restrictions on Copying the Software

Licensee may make a single copy of the Software in whole or in part solely for back-up purposes.

Article 4 Computer

Licensee may only use the Software on a single computer at a single location.

Article 5 Reverse Engineering, Decompiling or Disassembly

Licensee may not reverse engineer, decompile, or disassemble the Software, except to the extent either of them is permitted under law or regulation of the country where Licensee resides. Matsushita, or its distributors or dealers will not be responsible for any defects in the Software or damage to Licensee caused by Licensee's reverse engineering, decompiling, or disassembly of the Software.

Article 6 Limitation of Liability

The Software is provided "AS-IS" without warranty of any kind, either expressed or implied, including, but not limited to, warranties of non-infringement, merchantability and/or fitness for a particular purpose. Further, Matsushita does not warrant that the operation of the Software will be uninterrupted or error free. Matsushita or any of its distributors or dealers will not be liable for any damage suffered by Licensee arising from or in connection with Licensee's use of the Software.

Article 7 Export Control

Licensee agrees not to export or re-export to any country the Software in any form without the appropriate export licenses under regulations of the country where Licensee resides, if necessary.

Article 8 Termination of License

The right granted to Licensee hereunder will be automatically terminated if Licensee violates any of the terms and conditions of this Agreement. Upon such automatic termination, Licensee must destroy the Software and related documentation together with all the copies thereof at Licensee's own expense.

When installing the software, log on to your PC as the Administrator (or with a user name with equivalent authorization) or with the user name for a standard user account. (If you do not have authorization to do this, consult your manager.)

- Before starting the installation, close any other software applications which are running.
- Do not perform any other operations on your PC while the software is being installed.

For Windows Vista:

If [User Account Control] dialog appears, click [Continue].

Installing VideoCam Suite

1 Insert the CD-ROM into the PC.

The [Setup Menu] screen will appear.

- If the [Setup Menu] screen does not appear, double-click the CD-ROM drive icon in [My Computer (Computer)].

2 Click [VideoCam Suite].



3 Click [Next].

4 Select where the application is to be installed, then click [Next].



5 Select [Yes] or [No] to create shortcut.

6 Select the country or region where you live, then click [Next].

- If the country or region cannot be selected, select [NTSC Area].



- When the confirmation message appears, click [Yes].

7 Click [Install] to start the installation process.



- ### 8
- When installation is complete, some notes will appear
Check the contents, then close the window.

- 9 Select [Yes, I want to restart my computer now.], then click [Finish].



The PC must be rebooted for the application to work.

- Depending on the operating environment, you may be required to install DirectX 9.0c. If so, click [Yes], and install it. If you install the software on a PC that is not compatible with DirectX 9.0c, the PC may not work properly. If you are unsure whether or not your PC is compatible, contact the PC manufacturer.

Uninstalling the software

Follow the steps below to uninstall the software if it is no longer required.

■ For Windows Vista

- 1 Select [Start] → [Control Panel] → [Uninstall a program].



- 2 Select [VideoCam Suite 1.0], then click [Uninstall].

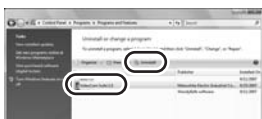

■ For Windows XP

- 1 Select [start] → [Control Panel] → [Add or Remove Programs].

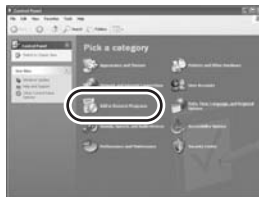

- 2 Select [VideoCam Suite 1.0], then click [Remove].



■ For Windows 2000

- 1 Select [Start] → [Settings] → [Control Panel] → [Add/Remove Programs].



- 2 Select [VideoCam Suite 1.0], then click [Change/Remove].

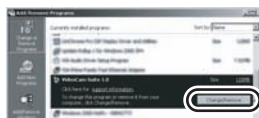

After the software is installed, the unit must be connected to the PC and be correctly recognized by the PC.

- Remove the supplied CD-ROM from your PC.

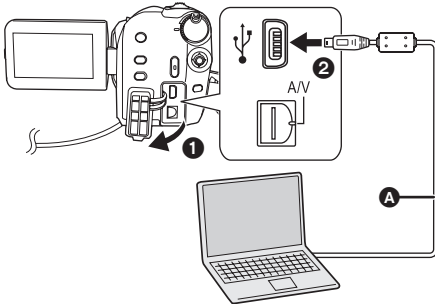

A USB cable (supplied)

- Insert the USB connectors as far as they will go.
- Do not use any other USB connection cables except the supplied one. (Operation is not guaranteed with any other USB cables.)

◇ Connect this unit to the AC adaptor and turn on the unit.

1 Connect this unit to a PC.

The USB function selection screen will appear.

2 Select [PC CONNECT] → [HDD] or [SD CARD] then press the joystick.

This unit is automatically detected by the PC.

- When the unit is connected to a PC, its power cannot be turned off. Disconnect the USB cable before turning this unit off. (→ 91)
- Do not disconnect the USB cable or AC adaptor while the access lamp is on or access icon (↺ or ↻) appears on the LCD monitor. Doing so may damage the data on the HDD or SD card.
- The HDD and SD card cannot be accessed simultaneously.
- It may be necessary to reboot the PC after connecting this unit to it for the first time.

About the PC display

When the unit is connected to a PC, it is recognized as an external drive.

- This unit supports only the readout of data using the PC. The PC cannot write data to the unit, or erase data from the unit.
- Depending on the operating environment of the PC, the shape of the drive icon and the drive name will differ.

■ Drive icons

The icon is displayed in [My Computer (Computer)].

When accessing the HDD

- Windows Vista:



- Windows XP:

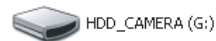

- Windows 2000:



When accessing the card

- Windows Vista:

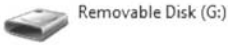

- Windows XP:

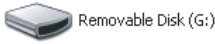

- Windows 2000:

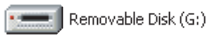

■ Example folder structure

HDD



SD card

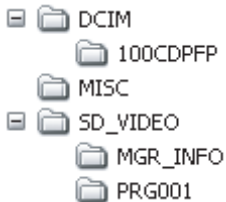

- SD-Video format motion pictures are stored in the [PRG***] folder. ("***" denotes base-16 (hexadecimal) characters from 001 to FFF.)
- Up to 99 files can be recorded in the [PRG***] folder.
- JPEG format still pictures (IMGA0001.JPG etc.) are stored in the [100CDPFP] folder.
- Up to 999 files can be recorded in the [100CDPFP] or other such folder.
- The DPOF setting files are stored in the [MISC] folder (SD card only).

■ Copying still pictures on PC

HDD or SD card reader function (mass storage)

When the unit is connected to a PC and the HDD or the SD card can be used as an external drive, still pictures on the drive can be copied to the PC with Windows Explorer or other programs.

- 1 Double click the folder that contains the files on the drive ([100CDPFP] etc.).
- 2 Drag and drop the files onto the destination folder (on the PC hard disk).

- Do not delete the SD card's folders. Doing so may make the SD card unusable in this unit.
- Always use this unit to format SD cards.

To disconnect USB cable safely

- 1 Double click the   icon in task tray.

Hardware disconnect dialog appears.

- Depending on your PC's settings, this icon may not be displayed.

- 2 Select [USB Mass Storage Device] and click [Stop].

- 3 Verify [MATSHITA HDD CAM-HDD USB Device] or [MATSHITA HDD CAM-SD USB Device] is selected and click [OK].

Click [Close], and you can safely disconnect the cable.

For Windows Vista:

- When using VideoCam Suite, log on to your PC as Administrator (or with a login name equally authorized) or with the user name for a standard user account. If you log on with a user name for a guest user account, the software cannot be used.

For Windows XP/2000:

- When using VideoCam Suite, log on to your PC as Administrator (or with a login name equally authorized). If you log on with a login name other than Administrator, the software cannot be used.

Select [start] → [All Programs (Programs)] → [Panasonic] → [VideoCam Suite 1.0] → [VideoCam Suite].



Refer to the operating instructions of the software (PDF file) for details on how to use it.

Reading the operating instructions of the software

- You will need Adobe Reader to read the PDF operating instructions. (→ 84)

Select [start] → [All Programs (Programs)] → [Panasonic] → [VideoCam Suite 1.0] → [Manual].



DVD COPY function

HDD

When VideoCam Suite is used, you can easily create DVD-Video discs by pressing the unit's DVD COPY button.

Among the motion pictures recorded on the unit's HDD, those scenes which have not yet been copied to the DVD using this function will be automatically identified and written onto the DVD.

DVD-Video discs created using this function can be played back on a DVD player or other devices.

◇ **Insert a DVD disc in a drive for DVD writing on the PC.**

1 Connect this unit to a PC. (→ 90)

2 Press the DVD COPY button.

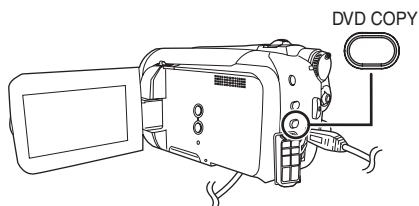

[Create DVD-Video Disc] screen appears.

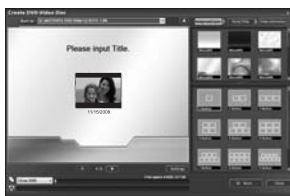

- Refer to the operating instructions of the software (PDF file) for details on how to use it.
- After copying is complete, a message appears. If [OK] is clicked, the USB function will be set to [PC CONNECT]. Before turning this unit off, disconnect the USB cable (→ 91).
- Any scenes that are copied with the DVD COPY function are indicated by the [☑] (copied icon) and can be deleted as a group using the deletion menu. (→ 60, 75)
- The order of the motion pictures on a disc are set automatically when the disc is created with the DVD COPY function. In order to designate the order in which the motion pictures are copied to a disc, import the motion pictures onto the PC, and then write them to the DVD disc. (→ 92)
- Once scenes have been copied using the DVD COPY function, they cannot be copied a second or subsequent time. Import the motion pictures onto the PC, and then write them to the DVD disc. (→ 92)

When deleting data on the HDD after making a copy, be sure to play back the discs to check that they have been copied correctly before deleting.

■ Operating environment for the card reader function (mass storage)

Personal computer	Macintosh
OS	Mac OS X v10.4
CPU	PowerPC G5 (1.8 GHz or higher) Intel Core Duo Intel Core Solo
RAM	64 MB or more
Interface	USB port

- Even if the system requirements mentioned in these operating instructions are fulfilled, some personal computers cannot be used.
- The USB equipment operates with the driver installed as standard in the OS.
- Supplied CD-ROM is available for Windows only.

■ Copying still pictures on PC

1 Connect this unit to a PC via the supplied USB cable.

- The USB function selection screen will appear.

2 Select [PC CONNECT] → [HDD] or [SD CARD] then press the joystick.

3 Double-click [HDD_CAMERA] or [NO NAME] displayed on the desktop.

- Files are stored in [100CDPFP] folder etc. in the [DCIM] folder.

4 Drag and drop the files onto destination folder (on the PC hard disk).

■ To disconnect USB cable safely

Drag [HDD_CAMERA] or [NO NAME] disk icon to the [Trash], and then disconnect the USB cable.

Preparation

Recording

Playback



With a PC

Others

96 Indications

101 Helpful hints

Media indications

	HDD is selected
	SD card is selected



Recording indications

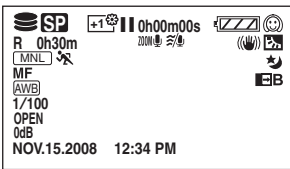



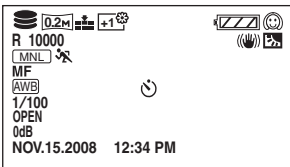















Motion picture recording



Still picture recording



	Remaining battery power (→ 20)
R 0h30m	Remaining time for recording
0h00m00s	Elapsed recording time
NOV.15.2008 12:34 PM	Date/time indication (→ 31)
●/ (Red)	Recording/writing to the medium (→ 35)
 (Green)	Recording pause (→ 35)
WIDE	Aspect ratio 16:9 (→ 47)
AUTO	Auto mode (→ 34)
MNL	Manual mode (→ 48)
MF	Manual focus (→ 50)
2×	Zoom magnification indication (→ 40)
	Back light compensation mode (→ 45)
	Image stabilizer (→ 42)
1/100	Shutter speed (→ 52)

OPEN, F2.0	F number (→ 52)
0dB	Gain value (→ 52)
	Soft skin mode (→ 45)
W, B	Fade (White), Fade (Black) (→ 45)
	MagicPix function (→ 45)
zOOM	Zoom microphone (→ 41)
	Wind noise reduction (→ 47)
	Power LCD plus function (→ 32)
XP, SP, LP	Motion picture recording mode (→ 37)
	Scene mode (→ 49)
	Sports mode
	Portrait mode
	Low light mode
	Spotlight mode
	Surf & snow mode
AWB	White balance (→ 50)
	Auto white balance
	Indoor mode (recording under incandescent lamp)
	Outdoor mode
	Manual adjustment mode
	Self-Timer recording (→ 45)
0.3m	Number of recording pixels for still pictures (→ 39)
0.2m	640×480
	640×360
	Recording/accessing the HDD
	(White) SD Card can be recorded to
	(Green) Recognizing the SD card
	Recording/accessing the SD card
	Still picture quality (→ 39)
R 10000	Remaining number of still pictures

■ Playback indications

Motion picture playback



Still picture playback

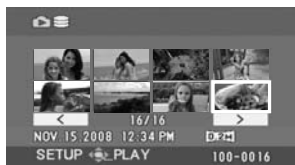

	Playback (→ 54)
	Pause (→ 54)
	Fast forward/rewind (→ 55)
	Last/first scene paused
	Skip playback (→ 54)
	Slow-motion playback (→ 55)
	Frame-by-frame playback (→ 55)
0h00m00s	Motion picture playback time
	Play mode (→ 56)
	All scenes on the media displayed
	Scenes recorded on the selected date displayed
	Scenes in the selected playlist displayed
	Motion picture recording mode (→ 37)
No.10	Scene number
	Volume adjustment (→ 55)
R	Resume playback (→ 55)
	Locked motion pictures and still pictures (→ 61, 67)
	Copied motion pictures (→ 75)
100-0001	Still picture folder/file number display



DPOF already set
(to more than 1) (→ 68)

Number of recording pixels for
still pictures (→ 39)

0.3M













640×480

0.2M





640×360

The picture size is not displayed for still pictures recorded with other products that have different picture sizes from the sizes shown above.

■ Indications when other products are connected

	The DVD burner is connected
	When the [BURN DISC] menu is selected
	When the [PLAY DISC] menu is selected
	Disc type (→ 73)
	DVD-RAM disc
	DVD-RW disc
	DVD-R disc
	DVD-R DL disc
	CD-RW disc
	CD-R disc
	When a printer compatible with PictBridge is connected (→ 81)
	Accessing the HDD or an SD card (→ 90)

■ Confirmatory indications

	The built-in battery is low. (→ 31)
	The warning/alarm indication appears when LCD monitor is rotated towards the lens side. Return the direction of the LCD monitor to normal position and check the warning/alarm indication.
	No SD card is inserted/ unusable card.
	The HDD cannot be accessed as the drop detection function has detected that the unit was dropped. If it detects that the unit is being continuously dropped, recording may stop.

RECOMMEND DATA BACK UP PERIODICALLY.

The capacity of the HDD is limited. We recommend backing up important recorded data periodically to a PC, etc., to protect it. This message does not indicate that there is a problem with this unit.

HDD BACKUP RECOMMENDED.

There is a possible problem with the HDD. Immediately copy the data on the HDD to a PC, etc., and then have the unit repaired.

THIS CARD CANNOT RECORD IN VIDEO MODE.

An 8 MB or 16 MB SD card has been inserted in video recording mode.

CHECK CARD.

This card is not compatible or it cannot be recognized by the unit.

ERROR OCCURRED. RECORDING IS STOPPED.

- When using an SD card that can be used for motion picture recording (→ 24)
When this message appears, it is recommended that you format the SD card being used. (→ 71)
When an SD card is formatted, all the data recorded on it will be deleted. Back up the data on the SD card to a PC, etc. before formatting the SD card.
- When using any other card
Use a Panasonic SD card or another SD card which can be used to record motion pictures. (→ 24)

THIS BATTERY CANNOT BE USED.

Use a battery that is compatible with this unit. (→ 18)
You are attempting to connect an AC adaptor not compatible with this unit. Use the supplied AC adaptor. (→ 21)
If using a Panasonic battery compatible with this unit (→ 18), eject the battery and then insert it again. If the message appears even after repeating this several times, this unit needs repair. Detach the power and contact consumer support (→ 122, 123). Do not attempt to repair it by yourself.

EXIT THE MENU THEN CHANGE TO MANUAL MODE.**CANCEL MAGICPIX MODE.**

You are attempting to use a function that cannot be used simultaneously.

SHAKE OR DROP HAS BEEN DETECTED. FAILED OPERATION. PLEASE WAIT A WHILE.

The unit has detected that it is being dropped so the operation has stopped.

CANNOT OPERATE. TEMPERATURE IS HIGH. PLEASE TURN OFF AND WAIT A WHILE.

The internal temperature of this unit is high so it cannot be operated. Turn off the power, wait until the temperature falls and then turn on the power again.

CANNOT OPERATE DUE TO LOW TEMPERATURE.

The internal temperature of this unit is extremely low so it cannot be operated.

If "Please Wait." appears after this message, wait a while without turning the unit off. It may take time until the unit can be used.

PUSH THE RESET SWITCH.

An irregularity in the unit has been detected. Remove the SD card then press the RESET button to restart the unit. (→ 107)

DISCONNECT USB CABLE.

The unit cannot correctly establish the connection to the PC or printer. Disconnect and reconnect the USB cable and then select the desired USB function again.

CANNOT OPERATE WHILE CONNECTED TO COMPUTER.

The unit's power cannot be turned off when the unit is connected to the PC.

ALL CONTENTS OF THIS DISC WILL BE DELETED. DO YOU WANT TO CONTINUE?

The inserted disc contains recorded data. Confirm the contents by using the device that recorded the data before deletion.

THIS SCENE COULD NOT BE READ SO COPYING ONTO DISC WAS ABORTED.

To copy the scene again, delete the displayed scene first.

AN ERROR OCCURRED IN THE DVD BURNER. DISCONNECT THE USB CABLE FROM THIS UNIT.

Remove the Mini AB USB Connection Cable from this unit, and then turn the power off and then on again.

About recovery

It is possible that the system cannot complete writing of a file normally when, for example, power is turned off for some reason during recording or editing.

If faulty management information is found when the HDD or an SD card is accessed, one of the following messages may appear. Be sure to follow the messages. (Repairing may take time depending on the error.)

HDD ERROR DETECTED. NOW REPAIRING DATA.

CARD ERROR DETECTED. NOW REPAIRING DATA.

- When you repair the data, use a battery with sufficient battery power or the AC adaptor. Even if the power is turned off without repairing the data, you can repair the data when you turn the power on again.
- Depending on the condition of the data, it may not be possible to completely repair the data.
- Do not repair an SD card that has been recorded on another device. This may cause the loss of data or the card.

Functions that cannot be used simultaneously

Some functions in this unit are disabled or cannot be selected due to the unit's specifications. The table below shows examples of functions restricted by various conditions.

Functions	Conditions which disable the functions
Digital zoom	<ul style="list-style-type: none"> • In picture recording mode
Fade	
MagicPix	<ul style="list-style-type: none"> • While recording (Cannot set or cancel) • In picture recording mode
Backlight compensation	<ul style="list-style-type: none"> • When the MagicPix function is used • When the iris/gain is set
Soft skin mode (Set and cancel)	<ul style="list-style-type: none"> • While recording
Help mode	
Scene mode	<ul style="list-style-type: none"> • In auto mode • When the MagicPix function is used
Change of white balance	<ul style="list-style-type: none"> • When digital zoom is used • When the MagicPix function is used
Adjusting the shutter speed, iris/gain	<ul style="list-style-type: none"> • When the MagicPix function is used • When the scene mode is used

? What kind of cards can be used on this unit?



SD Memory Cards and SDHC Memory Cards can be used. (→ 22)

To record motion pictures, we recommend using SD cards from 256 MB to 8 GB that conform to Class 2 or higher of the SD Speed Class Rating.

? Can I record continuously from the HDD to an SD card or vice versa?



No, you cannot record continuously.

Use [MEDIA SELECT] on the menu to switch the recording destination. (→ 35, 38)

? Is it possible to copy data on the HDD and an SD card with this unit?



Copying still pictures is possible. (→ 69)

Copying motion pictures is not possible.

? What should I do when the HDD is full?



Use the supplied software to back up the data to a PC or a DVD disc.

Images can also be copied to a disc by connecting this unit to the optional DVD burner.

After that, delete unnecessary scenes or format the HDD. (→ 59, 71)

■ With a DVD burner

? What type of device is required for playback of a disc created with the DVD burner?



A disc created with the DVD burner can be played back with a DVD player. (For disc compatibility, refer to the operating instructions of the player.)

The DVD burner is capable of recording a maximum of 9999 still pictures on a single disc. Since the maximum number of still pictures that can be played back may vary with the player, some of the still pictures on the disc may not play back.

If the device is not capable of playing the disc, connect the DVD burner to this unit for playback.

■ With a PC

? Can I write data from a PC onto the unit's HDD or SD card?



No, you cannot.
This unit's USB terminal is read only.

? Is playback and editing possible on a PC?



Use VideoCam Suite.

? Can I use the DVD COPY function to copy motion pictures recorded on SD cards onto DVD discs as well?



No, you cannot.
You can use the DVD COPY function to copy only the motion pictures recorded on the HDD.
If you want to copy motion pictures from an SD card to a DVD disc, copy the motion pictures to a PC first and then copy them to a DVD disc. (→ 92)

Problem	Check points
<p>This unit cannot be turned on.</p> <p>This unit does not stay on long enough.</p> <p>Battery runs down quickly.</p>	<ul style="list-style-type: none"> ● Charge the battery using the AC adaptor. (→ 18) ● The battery protection circuit may have operated. Attach the battery to the AC adaptor for 5 to 10 seconds. If the unit still cannot be used, the battery is faulty. ● Make sure the LCD monitor is opened. ● The battery is affected by ambient temperature. In cold places, the battery using time becomes shorter. ● The battery has a limited life. If the operating time is still too short even after the battery is fully charged, the battery has worn out and needs to be replaced.
<p>This unit is turned off automatically.</p>	<ul style="list-style-type: none"> ● If you do not use the unit for approximately 5 minutes, the power is automatically turned off to conserve battery life. To resume recording, turn the power back on. The power will not turn off automatically when the power save function (→ 29) is set to [OFF].
<p>This unit cannot be operated though it is turned on.</p> <p>This unit does not operate normally.</p>	<ul style="list-style-type: none"> ● The unit cannot be operated unless you open the LCD monitor. ● Remove the SD card then press the RESET button. (→ 107) If normal conditions are not restored yet, remove the battery or AC adaptor, wait about 1 minute and then reconnect the battery or AC adaptor. Then about 1 minute later, turn on the power again. (Conducting the above operation when the access lamp is on may destroy the data on the HDD or the SD card.)
<p>A clicking sound is heard when the power is turned off.</p>	<ul style="list-style-type: none"> ● This is the sound of the lens moving and is not a malfunction.
<p>The screen has changed suddenly. (Demo mode is on)</p>	<ul style="list-style-type: none"> ● If you set [DEMO MODE] to [ON] without inserting an SD card in video recording mode or picture recording mode, the unit is automatically set to the demonstration mode for introducing its functions. Normally this should be set to [OFF]. (→ 30)

Problem	Check points
<p>A function indication such as the remaining time indication or the elapsed time indication is not shown.</p>	<ul style="list-style-type: none"> ● If you set [SETUP]→[DISPLAY]→[OFF], indications other than warnings and date are not displayed.
<p>Recording does not start although power is supplied to this unit.</p>	<ul style="list-style-type: none"> ● No recording is possible while the SD card's write protect switch is set to LOCK. (→ 23) ● If the HDD or SD card has no more available memory, free up some memory by deleting unnecessary scenes (→ 59) or use a new SD card. ● Is the unit set to the video recording mode or picture recording mode? ● If the SD card slot cover is open, this unit may not operate normally. Close the card slot cover.
<p>Recording starts but stops immediately.</p> <p>The playback picture breaks up for a moment.</p>	<ul style="list-style-type: none"> ● The unit is hot. Follow the messages on the display. To use the unit again, turn the unit off and leave it for a while. ● If the recording stops when the HDD is used, back up the data on the HDD to a PC, etc. and then format the HDD. (→ 71)
<p>The operation arbitrarily stops.</p>	<ul style="list-style-type: none"> ● The drop detection function has activated to protect the HDD. Do not drop or shake this unit while operating it.
<p>Recording stops suddenly during motion picture recording on an SD card.</p>	<ul style="list-style-type: none"> ● Use an SD card that can be used for motion picture recording. (→ 24) ● When using an SD card on which data has been written many times and the data writing speed has reduced, the recording may suddenly stop during motion picture recording. Back up the data on the SD card to a PC, etc. and then format the SD card. (→ 71)
<p>Recorded still pictures are not clear.</p>	<ul style="list-style-type: none"> ● If you try to record small or finely detailed objects with [PICT.QUALITY] set at [FINE], the images may break up into a mosaic-like pattern. Record with [PICT.QUALITY] set at [NORMAL] instead. (→ 39)
<p>Auto focus function does not work.</p>	<ul style="list-style-type: none"> ● Press the AUTO button. ● There are some recording subjects and surroundings for which the auto focus does not operate correctly. (→ 112) If so, use the manual focus mode to adjust the focus. (→ 50)

Problem	Check points
<p>“CHECK THE LENS COVER.” is displayed.</p>	<ul style="list-style-type: none"> • Open the lens cover before turning the unit on. • This message may appear if you try to record in extremely dark places.
<p>Sound is not played back from the built-in speaker of this unit.</p>	<ul style="list-style-type: none"> • During playback, move the volume lever to display the volume indication and adjust it. (→ 55)
<p>Although this unit is correctly connected to a TV, playback images cannot be seen.</p> <p>The playback images are squeezed horizontally.</p>	<ul style="list-style-type: none"> • Please read the operating instructions of your TV and select the video input that this unit is connected to. • Change the setting to match the aspect ratio of the TV. (→ 72)
<p>Scenes or files cannot be deleted or edited.</p>	<ul style="list-style-type: none"> • Locked scenes or files cannot be deleted. Release the lock setting. (→ 61, 67) • It may not be possible to delete scenes that are displayed as [(!)] on the thumbnail display. If the scenes are unnecessary, format the HDD or the SD card to erase the data. (→ 71) Please be aware that if the HDD or the SD card is formatted then all the data recorded on the HDD or the SD card will be erased. • If the SD card's write protect switch is set to LOCK, then deletion and editing are disabled. (→ 23)
<p>The images on the SD card do not look normal.</p>	<ul style="list-style-type: none"> • The data may be destroyed. It may have been destroyed by static or electromagnetic waves. Store important data on a PC or other products as well.
<p>Even if HDD or an SD card is formatted, it cannot be used.</p>	<ul style="list-style-type: none"> • Either this unit or the SD card may be damaged. Please contact consumer support (→ 122, 123). • Use an SD card from 8 MB to 8 GB with this unit. (→ 22)
<p>The indication disappears.</p> <p>The screen is frozen.</p> <p>No operation can be performed.</p>	<ul style="list-style-type: none"> • No operation can be performed on this unit when it is connected to a PC. • Turn off the power to this unit. If the power cannot be turned off, remove the SD card then press the RESET button, or remove the battery or AC adaptor and then reinsert it. Turn on the power again. If normal operation is still not restored, detach the power connected, and contact consumer support (→ 122, 123).

Problem

“PUSH THE RESET SWITCH.” is displayed.

When the SD card is inserted in this unit, it is not recognized.

When the SD card is inserted in another device, it is not recognized.

Check points

- The unit has automatically detected an error. Remove the SD card then press the RESET button to restart the unit. Press the RESET button with the projecting part of the grip **A**.

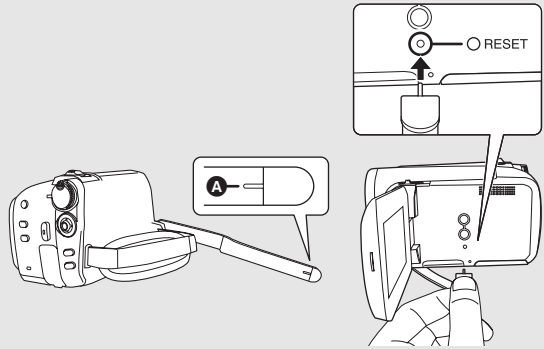

- If you do not press the RESET button, the power to this unit is turned off automatically about 1 minute later.
- Even after you press the RESET button, the indication may still appear repeatedly. If so, this unit needs repair. Detach the power connected, and contact consumer support (→ 122, 123). Do not attempt to repair the appliance by yourself.



- Use this unit to format SD cards. Please be aware that if an SD card is formatted, then all the data recorded on the card will be erased. (→ 71)

- Check that the device is compatible with the capacity or type of SD card (SD Memory Card/SDHC Memory Card) that you inserted. Refer to the operating instructions of the device for details.

With other products

Problem	Check points
<p>The sound does not play back properly when a DVD disc that has been copied using the DVD burner is played back.</p>	<ul style="list-style-type: none">• When the scenes recorded on an SD card by setting [AUDIO REC] to [MPEG] are copied to a DVD disc using the DVD burner and then played back with any other devices, sound may not play back properly. In this case, record scenes by setting [AUDIO REC] to [DOLBY] and then copy to the disc. Or use the software supplied with this unit to copy the scenes.

With a PC

Problem	Check points
<p>When connected by the USB cable, this unit is not detected by the PC.</p>	<ul style="list-style-type: none">• Close the menu screen before connecting the USB cable.• Select another USB terminal on the PC.• Check the operating environment. (→ 85)• Disconnect the USB cable, turn the unit off then on and then reconnect the USB cable.
<p>When the USB cable is disconnected, an error message will appear on the PC.</p>	<ul style="list-style-type: none">• To disconnect the USB cable safely, double-click the  () icon in the task tray and follow the instructions on the screen.
<p>The DVD COPY function will not start even when I press the DVD COPY button.</p>	<ul style="list-style-type: none">• To create DVD-Video discs using the DVD COPY function, you need to install VideoCam Suite from the supplied CD-ROM to your PC. (→ 88)
<p>I cannot copy motion pictures using the DVD COPY function.</p>	<ul style="list-style-type: none">• Once motion pictures have been copied using the DVD COPY function, they cannot be copied a second or subsequent time. Import the motion pictures onto the PC, and then write them on the DVD disc.
<p>It takes a long time to create a DVD.</p>	<ul style="list-style-type: none">• Creating a DVD may take some time even if the size of the motion picture files are small.
<p>The DVD player cannot play back the discs I have created using VideoCam Suite.</p>	<ul style="list-style-type: none">• To playback a DVD disc created using VideoCam Suite, the player must support playback of that DVD disc. (Refer to the operating instructions of the player.)

Cautions for use

About this unit

- The unit and SD card become warm after long operation, but this is not a malfunction.

Keep the SD Card/Hard Disk Video Camera as far away as possible from electromagnetic equipment (such as microwave ovens, TVs, video games etc.).

- If you use the SD Card/Hard Disk Video Camera on top of or near a TV, the pictures and sound on the SD Card/Hard Disk Video Camera may be disrupted by electromagnetic wave radiation.
- Do not use the SD Card/Hard Disk Video Camera near cell phones because doing so may result in noise adversely affecting the pictures and sound.
- Recorded data may be damaged, or pictures may be distorted, by strong magnetic fields created by speakers or large motors.
- Electromagnetic wave radiation generated by microprocessors may adversely affect the SD Card/Hard Disk Video Camera, disturbing the pictures and sound.
- If the SD Card/Hard Disk Video Camera is adversely affected by electromagnetic equipment and stops functioning properly, turn the SD Card/Hard Disk Video Camera off and remove the battery or disconnect AC adaptor. Then reinsert the battery or reconnect AC adaptor and turn the SD Card/Hard Disk Video Camera on.

Do not use the SD Card/Hard Disk Video Camera near radio transmitters or high-voltage lines.

- If you record near radio transmitters or high-voltage lines, the recorded pictures and sound may be adversely affected.

Make sure to use the supplied cords and cables. If you use optional accessories, use the cords and the cables supplied with them. Do not extend the cords and the cables.

Do not spray insecticides or volatile chemicals onto the unit.

- If the unit is sprayed with such chemicals, its body may be marred and the surface finish may peel off.
- Do not leave rubber or plastic products in contact with the unit for a long time.

When you use the unit in a sandy or dusty place such as a beach, do not let sand or fine dust get into the body and terminals of the unit.

Also, keep the unit away from sea water.

- Sand or dust may damage the unit. (Care should be taken when inserting and removing an SD card.)
- If sea water splashes onto the unit, wipe off the water with a well wrung cloth. Then wipe the unit again with a dry cloth.

When carrying the unit, do not drop or bump it.

- A strong impact can break the unit's casing, causing it to malfunction.

Do not use benzine, paint thinner or alcohol for cleaning the unit.

- Before cleaning, detach the battery or pull out the AC cable from the AC outlet.
- The camera body may be discolored and the surface finish may peel off.
- Wipe the unit with a soft dry cloth to remove dust and fingerprints. To remove stubborn stains, thoroughly wring a cloth that has been soaked in a neutral detergent diluted with water and wipe the unit with it. Afterwards, wipe it with a dry cloth.
- When you use a chemical dust cloth, follow the instructions that came with the cloth.

Do not use the unit for surveillance purposes or other business uses.

- This unit was designed for consumer intermittent use. It was not intended for continuous use, or for any industrial or commercial application resulting in prolonged use.
- In certain situations, continuous use could cause the unit to overheat and cause a malfunction. Such use is strongly discouraged.

When you are not going to use the unit for an extended time

- When storing the unit in a cupboard or cabinet, it is recommended that you place a desiccant (silica gel) in with it.

About the battery

The battery used in this unit is a rechargeable lithium-ion battery. It is susceptible to humidity and temperature and the effect increases the more the temperature rises or falls. In cold areas, the full charge indication may not appear or the low battery indication may appear for about 5 minutes after starting use. At high temperatures, the protection function may be triggered, making it impossible to use the unit.

Be sure to detach the battery after use.

- If the battery is left inserted, a minute amount of current continues to flow even if the unit's power is off. Keeping the unit in this state may result in over discharge of the battery. This may result in you not being able to use the battery even after it is charged.
- The battery should be stored in the vinyl bag so metal does not come into contact with the terminals.
- The battery should be stored in a cool place free from humidity, with as constant temperature as possible. (Recommended temperature: 15 °C to 25 °C (59 °F to 77 °F), Recommended humidity: 40% to 60%)
- Extremely high temperatures or low temperatures will shorten the life of the battery.
- If the battery is kept in high-temperature, high-humidity, or oily-smoky places, the terminals may rust and cause malfunctions.
- To store the battery for a long period of time, we recommend you charge it once every year and store it again after you have completely used up the charged capacity.
- Dust and other matter attached to the battery terminals should be removed.

Prepare spare batteries when going out for recording.

- Prepare enough batteries to last 3 to 4 times the period you are planning to record.
- Cold weather, such as when skiing, can shorten the recording period.

If you drop the battery accidentally, check to see if the terminals are damaged.

- Inserting a battery with damaged terminals can damage the unit or AC adaptor.

Do not throw old battery into fire.

- Heating a battery or throwing it into a fire may result in an explosion.
- If the operating time is very short even after the battery has been recharged, the battery has worn out. Please purchase a new battery.

About the AC adaptor

- If the temperature of the battery is extremely high or extremely low, charging may take time or the battery may not be charged.
- If the CHARGE lamp keeps flashing, make sure that the terminals of the battery or the AC adaptor are not exposed to dirt, foreign objects or dust, then reconnect them properly. If the charging lamp is still flashing, something may be wrong with the battery or AC adaptor. Contact consumer support (→ 122, 123).
- If you use the AC adaptor near a radio, radio reception may be disturbed. Keep the AC adaptor 1 m (3.3 feet) or more away from the radio.
- When using the AC adaptor, it may generate whirring sounds. However, this is normal.
- After use, be sure to disconnect the AC adaptor. (If it is left connected, a minute amount of current is consumed.)
- Always keep the electrodes of the AC adaptor and battery clean.

LCD monitor

- When the LCD monitor gets dirty, wipe it with a dry soft cloth.
- In a place with drastic temperature changes, condensation may form on the LCD monitor. Wipe it with a soft dry cloth.
- When the unit has become very cold, for example due to storage in a cold area, its LCD monitor will be slightly darker than usual immediately after the power is turned on. The normal brightness will be restored when the unit's internal temperature rises.

Extremely high precision technology is employed to produce the LCD Monitor screen featuring a total of approximately 123,000 pixels. The result is more than 99.99% effective pixels with a mere 0.01% of the pixels inactive or always lit. However, this is not a malfunction and does not affect the recorded picture.

About condensation

If condensation forms on the unit, the lens will cloud up, the HDD may be damaged and the unit may not work properly. Make every effort to ensure that condensation does not form. If it does form, take the actions described below.

Causes of condensation

Condensation takes place when the ambient temperature or humidity is changed as follows.

- When this unit is brought inside from the cold (e.g. a ski slope) to a warm room.
- When this unit is moved from an air-conditioned car to outside.
- When a cold room has been warmed up quickly.
- When cool wind from an air conditioner is directly blown onto this unit.
- After summer afternoon showers of rain.
- When this unit is in a very humid place where the air is thick with steam. (e.g. a heated swimming pool)

Helpful hint

If, for example, you have used this unit for recording on a ski slope and are taking it into a heated room, place the unit inside a plastic bag, remove as much of the air from inside the bag as possible, then seal the bag. Leave the unit for about an hour in the room so the temperature of the unit is close to the ambient temperature of the room, then use it.

Licenses

- SDHC Logo is a trademark.
- U.S. Patent Nos. 6,836,549; 6,381,747; 7,050,698; 6,516,132; and 5,583,936.
This product incorporates copyright protection technology that is protected by U.S. patents and other intellectual property rights. Use of this copyright protection technology must be authorized by Macrovision, and is intended for home and other limited viewing uses only unless otherwise authorized by Macrovision. Reverse engineering or disassembly is prohibited.
- Manufactured under license from Dolby Laboratories.
Dolby and the double-D symbol are trademarks of Dolby Laboratories.
- Microsoft®, Windows®, Windows Vista®, DirectDraw®, DirectSound®, DirectX®, and Internet Explorer® are either registered trademarks or trademarks of the Microsoft Corporation in the United States and/or other countries.
- Microsoft product screen shot(s) reprinted with permission from Microsoft Corporation.
- IBM, PC/AT and PowerPC are registered trademarks of International Business Machines Corporation of the U.S.
- Intel®, Core™ and Pentium® are the registered trademarks or trademarks of the Intel Corporation in the United States and other countries.
- Macintosh and Mac OS are either registered trademarks or trademarks of Apple Inc. in the United States and/or other countries.
- Other names of systems and products mentioned in these instructions are usually the registered trademarks or trademarks of the manufacturers who developed the system or product concerned.

Explanation of terms

Automatic white balance

White balance adjustment recognizes the color of light and adjusts so the white color will become a purer white. The unit determines the hue of light that comes through the lens and white balance sensor, thereby judging the recording condition, and selects the closest hue setting.

This is called automatic white balance adjustment.

However, since the unit only stores white color information under certain light sources, automatic white balance adjustment does not function normally under other light sources.

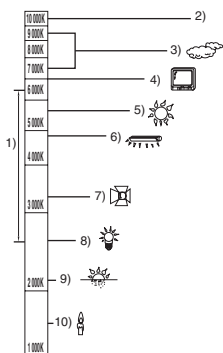

The illustration above shows the range over which the auto white balance functions.

- 1) The effective range of automatic white balance adjustment on this unit
- 2) Blue sky
- 3) Cloudy sky (rain)
- 4) TV screen
- 5) Sunlight
- 6) White fluorescent lamp
- 7) Halogen light bulb
- 8) Incandescent light bulb
- 9) Sunrise or sunset
- 10) Candlelight

Outside of the effective range of automatic white balance adjustment, the image will become reddish or bluish. Even within the effective range of automatic white balance adjustment, the automatic white balance adjustment may not function properly if there is more than one light

source. For light outside the functional automatic white balance adjustment range, use the manual white balance adjustment mode.

White balance adjustment

White balance adjustment determines the white color under different light sources. By recognizing which is the white color under sunlight and which is the white color under a fluorescent light, the unit can adjust the balance among the other colors.

Since the white color is the reference for all the colors, the unit can record pictures in a natural hue if it can recognize the reference color white.

Auto focus

The lens is moved forward or backward automatically to bring the subject into focus.

Auto focus has the following characteristics.

- Adjusts the focus so that the vertical lines of a subject are seen more clearly.
- Attempts to bring an object with higher contrast into focus.
- Focuses on the screen center only.

Due to these characteristics, auto focus does not work correctly in the following situations. Record pictures in the manual focus mode.

Recording distant and close-up objects at the same time

Since the unit focuses on whatever is at the center of the screen, it is difficult to bring the background into focus when close-up objects are placed in focus. When recording people with distant mountains in the background, you cannot focus on both the subject which is close-up and the objects which are in the distance.

Recording a subject behind dirty or dusty window

The subject behind the window will not be focused because the focus is on the dirty window.

Similarly, when recording something on the opposite side of a road with heavy traffic, a vehicle that happens to pass by may be brought into focus.

Recording a subject that is surrounded by objects with glossy surfaces or by highly reflective objects

Since whatever is shiny or glistens is brought into focus, it is hard to focus on the subject to be recorded. The focus may become blurry when recording subjects at the beach, at night views or in scenes involving fireworks or special lights.

Recording a subject in dark surroundings

The unit cannot focus correctly because the light information that comes through the lens decreases considerably.

Recording a fast-moving subject

As the focus lens-inside moves mechanically, it cannot keep up with a fast-moving subject. When, for example, recording a sports event with fast moving subjects, the focus may lose its sharpness.

Recording a subject with little contrast

It is easy to bring subjects with a sharp contrast or vertical lines or stripes into focus. This means that a subject with little contrast, such as a white wall, may become blurry because the unit achieves focus based upon the vertical lines of an image.

Specifications

SD Card/Hard Disk Video Camera

Information for your safety

Power source:	DC 9.3 V/7.2 V
Power consumption:	Recording 4.0 W

Signal system	EIA Standard: 525 lines, 60 fields NTSC color signal
Recording format	SD card: Based on the SD-Video standard HDD: Independent standard
Image sensor	1/6" CCD image sensor Total: 800 K Effective pixels: Moving picture: 290 K (4:3), 380 K (16:9) Still picture: 290 K (4:3), 380 K (16:9)
Lens	Auto Iris, F1.9 to F4.3 Focal length: 1.8 mm to 75.6 mm Macro (Full range AF)
Zoom	42x optical zoom, 70x/2000x digital zoom
Monitor	2.7" wide LCD monitor (approx. 123 K pixels)
Microphone	Stereo (with a zoom function)
Speaker	1 round speaker \varnothing 20 mm
Standard illumination	1,400 lx
Minimum required illumination	6 lx [approx. 2 lx with the MagicPix function]
Video output level	1.0 Vp-p, 75 Ω
Audio output level (Line)	316 mV, 600 Ω
USB	Card reader function (No copyright protection support) HDD reader function Hi-Speed USB (USB 2.0) compliant USB terminal Type Mini AB PictBridge-compliant USB host function (for DVD burner)
Dimensions (excluding the projecting parts)	67 mm (W) \times 70 mm (H) \times 116 mm (D) [2.68" (W) \times 2.80" (H) \times 4.64" (D)]
Mass (Weight) (without battery)	Approx. 340 g (0.75 lbs.)
Operating temperature	0 $^{\circ}$ C to 40 $^{\circ}$ C (32 $^{\circ}$ F to 104 $^{\circ}$ F)
Operating humidity	10% to 80%
Operating altitude	Less than 3000 m (9800 feet) above sea level

Motion pictures

Recording media	SD Memory Card (removable type): 32 MB* ¹ /64 MB* ¹ /128 MB* ¹ /256 MB/512 MB/1 GB/2 GB (FAT12 and FAT16 format corresponding) SDHC Memory Card (removable type): 4 GB/8 GB (FAT32 format corresponding) HDD (fixed type): 40 GB* ²
Compression	MPEG-2
Recording mode and transfer rate	XP: 10 Mbps (VBR) SP: 5 Mbps (VBR) LP: 2.5 Mbps (VBR)
Recordable time	Refer to page 37.
Audio compression	SD card: Dolby Digital/MPEG-1 Audio Layer 2 HDD: Dolby Digital 16 bit (48 kHz/2 ch)
Maximum number of recordable folders and scenes	SD card: 99 folders×99 scenes (9801 scenes) HDD: 999 folders×99 scenes (98901 scenes) (When the date changes, a new folder is created and scenes are recorded in this new folder even if the number of scenes in the old folder has not reached 99.)

*1 Cannot be guaranteed in operation.

*2 The 40 GB hard drive utilizes a portion of the storage space for formatting, file management and other purposes. 40 GB is 40,000,000,000 bytes. Usable capacity will be less.

Still pictures

Recording media	SD Memory Card (removable type): 8 MB/16 MB/32 MB/64 MB/128 MB/256 MB/512 MB/1 GB/2 GB (FAT12 and FAT16 format corresponding) SDHC Memory Card (removable type): 4 GB/8 GB (FAT32 format corresponding) HDD (fixed type): 40 GB*
Compression	JPEG (Design rule for Camera File system, based on Exif 2.2 standard), DPOF corresponding
Picture size	640×480 (4:3), 640×360 (16:9)
Number of recordable pictures	Refer to page 117.

* The 40 GB hard drive utilizes a portion of the storage space for formatting, file management and other purposes. 40 GB is 40,000,000,000 bytes. Usable capacity will be less.

AC adaptor





Information for your safety



Power source:	AC 110 V to 240 V, 50/60 Hz
Power consumption:	19 W
DC output:	DC 9.3 V, 1.2 A (Unit operation) DC 8.4 V, 0.65 A (Battery charging)

Dimensions	92 mm (W) × 33 mm (H) × 61 mm (D) [3.6" (W) × 1.3" (H) × 2.4" (D)]
Mass (Weight)	Approx. 115 g (0.25 lbs.)







Specifications may change without prior notice.

Number of recordable pictures on the HDD or an SD card

Picture size		0.3m (640×480)		0.2m (640×360)	
Picture quality					
HDD	40 GB	99999	99999	99999	99999
SD	8 MB	37	75	37	75
	16 MB	92	185	92	185
	32 MB	200	410	200	410
	64 MB	430	850	430	850
	128 MB	820	1640	820	1640
	256 MB	1710	3410	1710	3410
	512 MB	3390	6780	3390	6780
	1 GB	6790	13580	6790	13580
	2 GB	13820	27640	13820	27640
	4 GB	27150	54290	27150	54290
8 GB	55260	99999	55260	99999	

- The number of recordable pictures depends on whether [] and [] are used together and on the subject being recorded.
- The memory capacity indicated on the label of an SD card is the total of the capacity for copyright protection and management and the capacity which can be used on the unit, a PC etc.
- The numbers shown in the table are approximations.
- If you record motion pictures on the HDD or an SD card, the number of recordable still pictures will become smaller.

Optional accessories

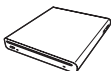
Accessory No.	Figure	Description
VW-AD21PP-K*1		AC adaptor with AC Cable and DC Cables
VW-VBG130*2		1320 mAh/Rechargeable Lithium Ion Battery Pack
VW-VBG260*2*3		2640 mAh/Rechargeable Lithium Ion Battery Pack
VW-VBG6*2*3		5800 mAh/Rechargeable Lithium Ion Battery Pack
VW-VH04		Battery Pack Holder Kit
RP-SDR01GU1A RP-SDR512U1A RP-SDR256U1A		Class 2 1 GB SD Memory Card Class 2 512 MB SD Memory Card Class 2 256 MB SD Memory Card
RP-SDM04GU1K RP-SDM02GU1A		Class 4 4 GB SDHC Memory Card Class 4 2 GB SD Memory Card
RP-SDV08GU1K RP-SDV04GU1K RP-SDV02GU1A RP-SDV01GU1A		Class 6 8 GB SDHC Memory Card Class 6 4 GB SDHC Memory Card Class 6 2 GB SD Memory Card Class 6 1 GB SD Memory Card
VW-BN1		DVD burner

*1 The supplied DC cables cannot be used on this unit.

*2 Please refer to page 20 about the battery charging time and available recording time.

*3 The battery pack holder kit VW-VH04 (optional) is necessary.

NOTE: Accessories and/or model numbers may vary by country. Please consult your local dealer.

Accessory Order Form (For USA Customers)

Please photocopy this form when placing an order.

1. Model # _____

2. Items Ordered

Accessory #	Description	Price Each	Quantity	Total Price
Subtotal				
Your State & Local Sales Tax				
Shipping & Handling				6.95
Total Enclosed				

3. Method of payment (check one)

- Check of Money Order enclosed (NO C.O.D.SHIPMENTS)
- VISA Credit Card # _____
- MasterCard Expiration Date _____
- Discover Customer Signature _____

Make Check or Money Order Payable to: PANASONIC ACCESSORIES

(Please do not send cash)

4. Shipping information (UPS delivery requires complete street address)

Ship To:

Mr.

Mrs.

Ms.

First

Last

Phone#:

Day () _____

Street Address

Night () _____

City

State

Zip

TO OBTAIN ANY OF OUR ACCESSORIES YOU CAN DO ANY OF THE FOLLOWING:
VISIT YOUR LOCAL PANASONIC DEALER

OR

CALL PANASONIC'S ACCESSORY ORDER LINE AT 1-800-332-5368

[6 AM-6 PM M-F, PACIFIC TIME]

OR

MAIL THIS ORDER TO: PANASONIC SERVICE AND TECHNOLOGY COMPANY

ACCESSORY ORDER OFFICE

20421 84th Avenue South Kent, WA. 98032

In CANADA, please contact your local Panasonic dealer for more information on Accessories.

Request for Service Notice (USA Only)

Please photocopy this form when making a request for service notice, in the unlikely event this product needs service.

Request for Service Notice:

- Please include your **proof of purchase**.
(Failure to do so will delay your repair.)
- To further speed your repair, please provide an explanation of what is wrong with the unit and any symptom it is exhibiting.

Mail this completed form and your Proof of Purchase along with your unit to:
Panasonic Camera and Digital Service Center
1590 Touhy Ave.
Elk Grove Village, IL 60007

Limited Warranty (For USA Customers)

PANASONIC CONSUMER ELECTRONICS
COMPANY, DIVISION OF PANASONIC
CORPORATION OF NORTH AMERICA
One Panasonic Way, Secaucus, New Jersey 07094

PANASONIC PUERTO RICO, INC.
Ave. 65 de Infantería, Km. 9.5 San Gabriel Industrial Park,
Carolina, Puerto Rico 00985

Panasonic Video Products Limited Warranty

Limited Warranty Coverage

If your product does not work properly because of a defect in materials or workmanship, Panasonic Consumer Electronics Company or Panasonic Puerto Rico, Inc. (collectively referred to as "the warrantor") will, for the length of the period indicated on the chart below, which starts with the date of original purchase ("warranty period"), at its option either (a) repair your product with new or refurbished parts, or (b) replace it with a new or a refurbished product. The decision to repair or replace will be made by the warrantor.

Product	Parts	Labor	Service	Contact Number
Camcorder	One (1) Year (except CCD Image Sensor) CCD Image Sensor - 6 (Six) Months	Ninety (90) Days Ninety (90) Days	Carry-In or Mail-In	1-800-211-PANA(7262)
DVD/VCR Deck, A/V Mixer	One (1) Year	Ninety (90) Days	Carry-In or Mail-In	1-800-211-PANA(7262)
TV/VCR, TV/DVD, TV/DVD/VCR Combination	One (1) Year (except CRT) CRT - Two (2) Years	Ninety (90) Days Ninety (90) Days	Carry-In: 21" CRT and Smaller In-Home or Carry-In: 22" CRT and Larger	1-800-211-PANA(7262)
TV/HDR Combination	One (1) Year (except CRT) CRT - Two (2) Years	Ninety (90) Days Ninety (90) Days	In-Home or Carry-In	1-888-843-9788
Rechargeable Batteries (in exchange for defective item)	Ten (10) Days	Not Applicable	Carry-In or Mail-In	1-800-211-PANA(7262)
Tape (in exchange for defective item)	Five (5) Days	Not Applicable	Carry-In or Mail-In	1-800-211-PANA(7262)
Memory Cards (in exchange for defective item)	Ninety (90) Days	Not Applicable	Carry-In or Mail-In	1-800-211-PANA(7262)

During the "Labor" warranty period there will be no charge for labor. During the "Parts" warranty period, there will be no charge for parts. You must carry-in or mail-in (prepaid) your product or arrange for in-home service, as applicable, during the warranty period.

If non-rechargeable batteries are included, they are not warranted. This warranty only applies to products purchased and serviced in the United States or Puerto Rico. This warranty is extended only to the original purchaser of a new product which was not sold "as is". A purchase receipt or other proof of the original purchase date is required for warranty service.

Carry-In, Mail-in (Prepaid) or In-Home Service

For Carry-In, Mail-In (prepaid) or In-Home Service (as applicable) in the United States call toll free contact number listed above or visit Panasonic Web Site: <http://www.panasonic.com>

For assistance in Puerto Rico call Panasonic Puerto Rico, Inc. (787)-750-4300 or fax (787)-768-2910.

In-Home service, if applicable, requires clear, complete and easy access to the product by the authorized servicer and does not include removal or re-installation of an installed product. It is possible that certain in-home repairs will not be completed in-home, but will require that the product, or parts of the product, be removed for shop diagnosis and/or repair and then returned.

Limited Warranty Limits And Exclusions

This warranty ONLY COVERS failures due to defects in materials or workmanship, and DOES NOT COVER normal wear and tear or cosmetic damage, nor does it cover markings or retained images on the picture tube resulting from viewing fixed images (including, among other things, letterbox pictures on standard 4:3 screen TV's, or non-expanded standard 4:3 pictures on wide screen TV's, or onscreen data in a stationary and fixed location). The warranty ALSO DOES NOT COVER damages which occurred in shipment, or failures which are caused by products not supplied by the warrantor, or failures which result from accidents, misuse, abuse, neglect, bug infestation, mishandling, misapplication, alteration, faulty installation, set-up adjustments, misadjustment of consumer controls, improper maintenance, power line surge, lightning damage, modification, or commercial use (such as in a hotel, office, restaurant, or other business), rental use of the product, service by anyone other than a Factory Service Center or other Authorized Servicer, or damage that is attributable to acts of God.

THERE ARE NO EXPRESS WARRANTIES EXCEPT AS LISTED UNDER "LIMITED WARRANTY COVERAGE". THE WARRANTOR IS NOT LIABLE FOR INCIDENTAL OR CONSEQUENTIAL DAMAGES RESULTING FROM THE USE OF THIS PRODUCT, OR ARISING OUT OF ANY BREACH OF THIS WARRANTY.

(As examples, this excludes damages for lost time, cost of having someone remove or re-install an installed unit if applicable, or travel to and from the servicer, loss of media or images, data or other memory or recorded content. The items listed are not exclusive, but are for illustration only.)

ALL EXPRESS AND IMPLIED WARRANTIES, INCLUDING THE WARRANTY OF MERCHANTABILITY, ARE LIMITED TO THE PERIOD OF THE LIMITED WARRANTY.

Some states do not allow the exclusion or limitation of incidental or consequential damages, or limitations on how long an implied warranty lasts, so the exclusions may not apply to you. This warranty gives you specific legal rights and you may also have other rights which vary from state to state. If a problem with this product develops during or after the warranty period, you may contact your dealer or Service Center. If the problem is not handled to your satisfaction, then write to the warrantor's Consumer Affairs Department at the addresses listed for the warrantor.

PARTS AND SERVICE (INCLUDING COST OF AN IN-HOME SERVICE CALL, WHERE APPLICABLE) WHICH ARE NOT COVERED BY THIS LIMITED WARRANTY ARE YOUR RESPONSIBILITY.

Customer Services Directory

Service in Canada: As per Service Center listed in Canadian warranty information → 123

Obtain Product Information and Operating Assistance; locate your nearest Dealer or Service Center; purchase Parts and Accessories; or make Customer Service and Literature requests by visiting our Web Site at:

<http://www.panasonic.com/consumersupport>

or, contact us via the web at:

<http://www.panasonic.com/contactinfo>

You may also contact us directly at:

1-800-211-PANA (7262),

Monday-Friday 9 am-9 pm; Saturday-Sunday 10 am-7 pm, EST

For hearing or speech impaired TTY users, TTY : 1-877-833-8855

Accessory Purchases

Purchase Parts, Accessories and Instruction Books online for all Panasonic Products by visiting our Web Site at:

<http://www.pstc.panasonic.com>

or, send your request by E-mail to:

npcparts@us.panasonic.com

You may also contact us directly at:

1-800-332-5368 (Phone) 1-800-237-9080 (Fax Only) (Monday – Friday 9 am to 9 pm, EST.)

Panasonic Service and Technology Company

20421 84th Avenue South,

Kent, WA 98032

(We Accept Visa, MasterCard, Discover Card, American Express, and Personal Checks)

For hearing or speech impaired TTY users, TTY : 1-866-605-1277

Product Repairs

Centralized Factory Service Center

MAIL TO:

Panasonic Camera and Digital Service Center

1590 Touhy Ave.

Elk Grove Village, IL 60007

Please carefully pack and ship, prepaid and insured, to the Elk Grove Village Centralized Factory Service Center

Customer's in Puerto Rico, please ship or carry in to location below ("Service in Puerto Rico").

Service in Puerto Rico

Panasonic Puerto Rico, Inc.

Ave. 65 de Infantería, Km. 9.5, San Gabriel Industrial Park,

Carolina, Puerto Rico 00985

Phone (787)750-4300, Fax (787)768-2910

As of January 2007

Warranty (For Canadian Customers)

Panasonic Canada Inc.

5770 Ambler Drive, Mississauga, Ontario L4W 2T3

PANASONIC PRODUCT – LIMITED WARRANTY

Panasonic Canada Inc. warrants this product to be free from defects in material and workmanship and agrees to remedy any such defect for a period as stated below from the date of original purchase.

Camcorder Product – One (1) year, parts and labour

LIMITATIONS AND EXCLUSIONS

This warranty does not apply to products purchased outside Canada or to any product which has been improperly installed, subjected to usage for which the product was not designed, misused or abused, damaged during shipping, or which has been altered or repaired in any way that affects the reliability or detracts from the performance, nor does it cover any product which is used commercially. Dry cell batteries are also excluded from coverage under this warranty.

This warranty is extended to the original end user purchaser only. A purchase receipt or other proof of date of original purchase is required before warranty service is performed.

THIS EXPRESS, LIMITED WARRANTY IS IN LIEU OF ALL OTHER WARRANTIES, EXPRESS OR IMPLIED, INCLUDING ANY IMPLIED WARRANTIES OF MERCHANTABILITY AND FITNESS FOR A PARTICULAR PURPOSE.

IN NO EVENT WILL PANASONIC CANADA INC. BE LIABLE FOR ANY SPECIAL, INDIRECT OR CONSEQUENTIAL DAMAGES.

In certain instances, some jurisdictions do not allow the exclusion or limitation of incidental or consequential damages, or the exclusion of implied warranties, so the above limitations and exclusions may not be applicable.

WARRANTY SERVICE

FOR PRODUCT OPERATION ASSISTANCE, please contact:

Our Customer Care Centre:	Telephone #:	(905) 624-5505
	1-800 #:	1-800-561-5505
	Fax #:	(905) 238-2360
	Email link:	“Customer support” on www.panasonic.ca

FOR PRODUCT REPAIRS, please locate your nearest Authorized Servicentre at www.panasonic.ca :

Link: “Servicentres™ locator” under “Customer support”

IF YOU SHIP THE PRODUCT TO A SERVICENTRE

Carefully pack and send prepaid, adequately insured and preferably in the original carton. Include details of the defect claimed, and proof of date of original purchase.

Index

■ A

AC adaptor	18, 21, 110
Aperture	52
Aspect ratio	47
Audio rec	36
Auto focus	112
Auto slow shutter	47
Automatic white balance	50, 112

■ B

Backlight compensation	45
Battery	18, 20, 110
Beep sound	29

■ C

Charging time	20
Copy	69

■ D

Date and time display	31
Delete	59
Demo mode	30
Digital zoom	40
Display	29
DPOF setting	68
Dubbing	80
DVD burner	73
DVD COPY button	93

■ F

Fade	45
Format	71
Frame-by-frame playback	55

■ G

Gain	52
Guideline	47

■ H

HDD	25
Management	71
Help mode	45

■ I

Image stabilizer function	42
Initial set	29
Iris	52

■ L

Language	29
LCD monitor	15, 32, 110
Locking motion pictures	61
Locking still pictures	67

■ M

MagicPix function	45
Manual focus	48, 50
Menu	28
Motion picture playback	54
Motion picture recording	35

■ N

Number of recordable pictures	117
-------------------------------	-----

■ O

Operation icons	43
-----------------	----

■ P

PictBridge	81
Picture quality	39
Picture size	39
Playing back motion pictures by date	56
Playlist	64
Power LCD plus	32
Power save	29

■ Q

Quick start	42
-------------	----

■ R

Recording mode	37
Recording time elapsed	36
Recovery	100
Remaining number of still pictures	38
Remaining time	36
Resume playback	55

■ S	
Scene mode	49
SD card	22, 26
Self-recording	41
Self-timer recording	45
Shutter effect	39
Shutter speed	52
Skip playback	54
Slow-motion playback	55
Soft skin mode	45
Still picture compatibility	58
Still picture playback	57
Still picture recording	38
■ T	
TV aspect	72
■ V	
Volume adjustment	55
■ W	
White balance	50, 112
Wind noise reduction function	47
■ Z	
Zoom	40
Zoom microphone	41

Spanish Quick Use Guide/Guía española para el uso rápido

■ Carga de la batería

- 1 Conecte el cable de CA al adaptador de CA y a la toma de CA.
- 2 Inserte la batería en el cargador de baterías alineando las flechas.

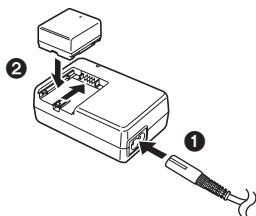

■ Inserción de la batería

Inserte la batería hasta escuchar un clic prestando atención a la dirección de la batería.

- **A** Apriete en el centro la batería hasta que quede bloqueada.

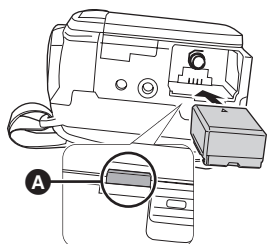

■ Extracción de la batería

Mientras pulsa el botón **A**, mueva **B** en la dirección de la flecha para desbloquearla y luego extraiga la batería.

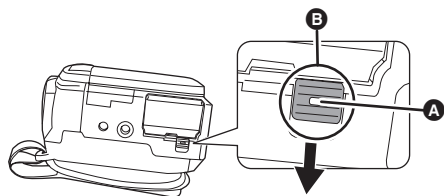

■ Cómo encender la cámara

Mientras pulsa el botón de desbloqueo **A**, ajuste el selector de modo a **B**, **C**, **D** o **E**.

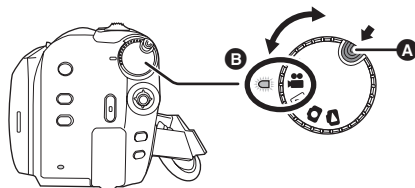

- Para apagar la cámara, ajuste el selector de modo a off.

■ Inserción de una tarjeta SD

- 1 Abra la tapa de la ranura para tarjetas SD y, a continuación, inserte la tarjeta SD.

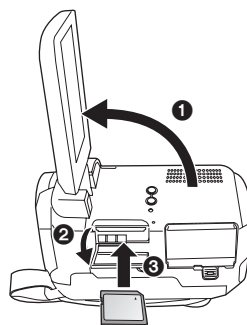

- 2 Cierre bien la tapa de la ranura para tarjetas SD.

■ Grabación de imágenes fijas

- Gire el selector de modo para seleccionar .

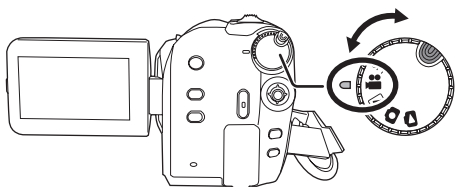

- 1 Pulse el botón MENU, luego seleccione [MEDIA SELECT] → [HDD] o [SD CARD] para seleccionar el destino de grabación y pulse el joystick.
- 2 Pulse el botón de inicio/detención de la grabación para empezar la grabación.

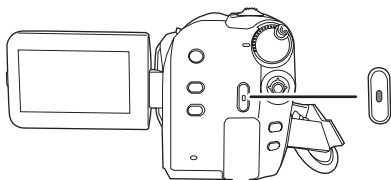

- 3 Pulse de nuevo el botón de inicio/detención de la grabación para interrumpir la grabación.

■ Grabación de imágenes fijas

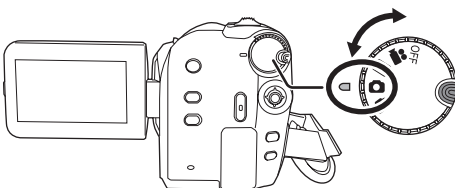

- Gire el selector de modo para seleccionar .

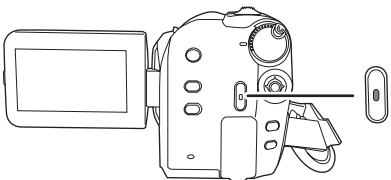

- 1 Pulse el botón MENU, luego seleccione [MEDIA SELECT] → [HDD] o [SD CARD] para seleccionar el destino de grabación y pulse el joystick.
- 2 Pulse el botón de inicio/detención de la grabación.



■ Reproducción

- Gire el selector de modo para seleccionar  o .

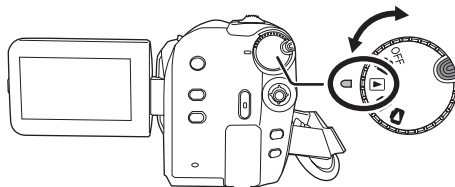

- 1 Pulse el botón MENU, luego seleccione [MEDIA SELECT] → [HDD] o [SD CARD] para seleccionar el medio de grabación deseado y pulse el joystick.
- 2 Seleccione la escena/fichero a reproducir y, a continuación, pulse el joystick.

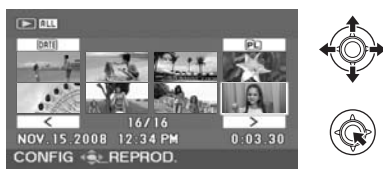

- 3 Seleccione la operación de reproducción con el joystick.

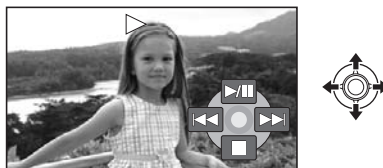

▶ Reproducción de imágenes en movimiento

- ▶/||: Reproducción/Pausa
- ◀◀: Salto reproducción (hacia atrás)
- ▶▶: alto reproducción (hacia delante)
- : Detiene la reproducción y muestra las miniaturas.

▶ Reproducción de imágenes fijas

- ▶/||: Inicio/pausa exposición de diapositivas.
- ◀◀: Reproduce la imagen anterior.
- ▶▶: Reproduce la imagen siguiente.
- : Detiene la reproducción y muestra las miniaturas.

**Panasonic Consumer Electronics Company,
Division of Panasonic Corporation of North America**

One Panasonic Way, Secaucus, NJ 07094

Panasonic Puerto Rico, Inc.

Ave. 65 de Infantería, Km. 9.5, San Gabriel Industrial Park, Carolina, Puerto Rico 00985

Panasonic Canada Inc.

5770 Ambler Drive, Mississauga, Ontario, L4W 2T3



LSQT1337 A
F1207MD

