

ENGLISH



Canon PowerShot S80

DIGITAL CAMERA



Advanced Camera User Guide

This guide explains camera features and procedures in detail.



Canon DIGITAL CAMERA PowerShot S80 Advanced Camera User Guide

Canon

About This Guide

Use of genuine Canon accessories is recommended.

This product is designed to achieve excellent performance when used with genuine Canon accessories. Canon shall not be liable for any damage to this product and/or accidents such as fire, etc., caused by the malfunction of non-genuine Canon accessories (e.g., a leakage and/or explosion of a battery pack). Please note that this warranty does not apply to repairs arising out of the malfunction of non-genuine Canon accessories, although you may request such repairs on a chargeable basis.

Camera Body Temperature

If your camera is used for prolonged periods, the camera body may become warm. Please be aware of this and take care when operating the camera for an extended period.

About the LCD Monitor and Viewfinder





The LCD monitor and viewfinder are produced with extremely high-precision manufacturing techniques. More than 99.99% of the pixels operate to specification. Less than 0.01% of the pixels may occasionally misfire or appear as red or black dots. This has no effect on the recorded image and does not constitute a malfunction.

Video Format

Please set the camera's video signal format to the one used in your region before using it with a TV monitor (p. 112).

Conventions Used in the Text

Icons appearing below titles indicate the modes that support that operation. In the example below, the mode dial can be used in the following shooting modes.

-  (Auto)
-  (Manual)
-  (My Colors)
-  (Movie)

Mode Dial



 : This mark denotes issues that may affect the camera's operation.

 : This mark denotes additional topics that complement the basic operating procedures.

You can use SD* memory cards and MultiMediaCards with this camera. These cards are collectively called memory cards in this guide.

* SD stands for Secure Digital, a copyright protection system.

Contents

Items marked with ☆ are lists or charts that summarize camera functions or procedures.

Please Read

Chapter 1 Preparing the Camera

Components Guide	10
Basic Operations	12
Operation Panel	12
Using the Multi Control Dial	14
Using the Viewfinder	14
Using the LCD Monitor	15
LCD Monitor Brightness	16
Shooting Information (Shooting Mode)	17
Playback Information- Mode	18
Playback Information-Detailed (Playback Mode)	19
Histogram Function	20
Changing the Review Duration	21
Power Saving Function	21
Formatting a Memory Card	23
Setting the World Clock	24
Menu List	26
FUNC. Menu	26
Rec. Menu	27
Play Menu	28
Set up Menu	29
My Camera Menu	31
Resetting Settings to Their Default Values	32





Chapter 2 Shooting

Changing Resolution/Compression Settings	33
Setting the Red-eye Reduction Function	34
Setting the Slow Synchro	35
⌚ Using the Self-timer	36
Using the Digital Zoom	39
📷 Continuous Shooting	40





Chapter 3 Using the Mode Dial

🎬 Shooting a Movie	41
📷 Shooting Panoramic Images (Stitch Assist)	45
Using the Mode Dial (Creative Zone)	48
P Program AE	50
TV Setting the Shutter Speed	50
Av Setting the Aperture	51
M Manually Setting the Shutter Speed and Aperture	52
📷 Shooting in a My Colors Mode	53

Chapter 4 Advanced Shooting Functions

 Registering Settings to the Shortcut Button	59
 Selecting an AF Frame	60
Shooting Problem Subjects for the Autofocus	62
Locking the Exposure Setting (AE Lock)	65
Locking the Flash Exposure Setting (FE Lock)	67
Switching between Metering Modes	68
 Adjusting the Exposure	69
Adjusting the Tone (White Balance)	70
Changing the Photo Effect	72
ISO Changing the ISO Speed	74
Auto Exposure Bracketing (AEB Mode)	75
Focus Bracketing (Focus-BKT Mode)	76
 Switching between Built-in Flash Adjustment Settings	77
Switching the Timing at which the Flash Fires	79
Shooting Images at Set Intervals (Intervalometer)	80
 Saving Custom Settings	82
Setting the Auto Rotate Function	83
Resetting the File Number	84
Create a save destination (folder)	86

Chapter 5 Playback/Erasing

 Magnifying Images	88
 Viewing Images in Sets of Nine (Index Playback)	88
The display jumps nine images at a time	89
 Jumping to Images	90
Triple Image Scrolling Display	91
Rotating Images in the Display	92
Applying Effects and Playing Back	93
Viewing/Editing Movies	94
 Attaching Sound Memos to Images	97
Automated Playback (Slide Shows)	99
Protecting Images	104
Erasing All Images	105

Chapter 6 Print Settings/Transfer Settings

About Printing	106
Setting the DPOF Print Settings	106
Image Transmission Settings (DPOF Transfer Order)	110

Chapter 7 Viewing Images on a TV set

Viewing Images on a TV Set	112
--------------------------------------	-----

Chapter 8 Customizing the Camera (My Camera Settings)	
Customizing the Camera (My Camera Settings)	113
Chapter 9 Troubleshooting	
Troubleshooting	117
Chapter 10 List of Messages	
List of Messages	122
Chapter 11 Appendix	
Battery Handling	125
Handling the Memory Card	127
Using the AC Adapter Kit (Sold Separately)	128
Car Battery Charger (Sold Separately)	129
Using Conversion Lenses (Sold Separately)	131
Using an Externally Mounted Flash (Sold Separately)	134
Camera Care and Maintenance	135
Specifications	136
Photo Tips and Information	144
INDEX	146
★ Functions Available in Each Shooting Mode	160

Please Read

Test Shots

Before you try to photograph important subjects, we highly recommend that you shoot several trial images to confirm that the camera is operating and being operated correctly.

Please note that Canon Inc., its subsidiaries and affiliates, and its distributors are not liable for any consequential damages arising from any malfunction of a camera or accessory, including memory cards, that results in the failure of an image to be recorded or to be recorded in a way that is machine readable.

Warning Against Copyright Infringement

Please note that Canon digital cameras are intended for personal use and should never be used in a manner that infringes upon or contravenes international or domestic copyright laws and regulations. Please be advised that in certain cases the copying of images from performances, exhibitions, or commercial properties by means of a camera or other device may contravene copyright or other legal rights even if the image was shot for personal use.

Warranty Limitations

This camera's warranty is only effective in the country of sale. If a problem arises while the camera is in use abroad, please convey it back to the country of sale before proceeding with a warranty claim to a Canon Customer Support Help Desk.

For Canon Customer Support contacts, please see the Canon Limited Warranty supplied with your camera.

Safety Precautions

- Before using the camera, please ensure that you read and understand the safety precautions described below. Always ensure that the camera is operated correctly.
- The safety precautions noted on the following pages are intended to instruct you in the safe and correct operation of the camera and its accessories to prevent injuries or damage to yourself, other persons and equipment.

- In the following pages, the term "equipment" refers primarily to the camera, its batteries and battery charger, separately sold compact power adapter, car battery charger and high-power flash.

About the Memory Card

Store the memory card out of the reach of children and infants. It may be swallowed accidentally. If this occurs, consult a doctor immediately.



Warnings

- **Do not aim the camera directly into the sun or at other intense light sources** that could damage your eyesight.
- **Do not trigger the flash in close proximity to human or animal eyes.** Exposure to the intense light produced by the flash may damage eyesight. In particular, remain at least one meter (39 inches) away from infants when using the flash.
- **Store this equipment out of the reach of children and infants.** Accidental damage to the camera or batteries by a child could result in serious injury. In addition, placement of the strap around a child's neck could result in asphyxiation.
- **Do not attempt to disassemble or alter any part of the equipment that is not expressly described in this guide.** Disassembly or alteration may result in high-voltage electrical shock. Internal inspections, alterations and repairs should be conducted by qualified service personnel authorized by your camera distributor or a Canon Customer Support Help Desk.
- **To avoid the risk of high-voltage electrical shock, do not touch the flash portion of the camera if it has been damaged.** Similarly, never touch internal portions of the equipment that become exposed as a result of damage. There is a risk of high-voltage electrical shock. Please take the first opportunity to consult your camera distributor or the closest Canon Customer Support Help Desk.
- **Stop operating the equipment immediately if it emits smoke or noxious fumes.** Failure to do so may result in fire or electrical shock. Immediately turn the camera's power off, remove the batteries and unplug the power cord from the power outlet. Confirm that smoke or fume emissions have ceased. Please consult your camera distributor or the closest Canon Customer Support Help Desk.
- **Stop operating the equipment immediately if it is dropped or the casing is damaged. Immediately turn the camera's power off, remove the batteries or unplug the power cord from the power outlet.** Continued use of the equipment may result in fire or electrical shock. Please consult your camera distributor or the closest Canon Customer Support Help Desk.

-
- **Do not allow the equipment to come into contact with, or become immersed in, water or other liquids. Do not allow liquids to enter the interior.** The camera has not been waterproofed. If the exterior comes into contact with liquids or salt air, wipe it dry with a soft, absorbent cloth. In the event that water or other foreign substances enter the interior, immediately turn the camera's power off and remove the batteries or unplug the power cord from the power outlet. Continued use of the equipment may result in fire or electrical shock. Please consult your camera distributor or the closest Canon Customer Support Help Desk.
-
- **Do not use substances containing alcohol, benzene, thinners or other flammable substances to clean or maintain the equipment.** The use of these substances may lead to fire.
-
- **Remove the power cord on a regular periodic basis and wipe away the dust and dirt that collects on the plug, the exterior of the power outlet and the surrounding area.** In dusty, humid or greasy environments, the dust that collects around the plug over long periods of time may become saturated with humidity and short-circuit, leading to fire.
-
- **Do not cut, damage, alter or place heavy items on the power cord.** Any of these actions may cause an electrical short circuit, which may lead to fire or electrical shock.
-
- **Do not handle the power cord if your hands are wet.** Handling it with wet hands may lead to electrical shock. When unplugging the cable, ensure that you hold the solid portion of the plug. Pulling on the flexible portion of the cable may damage or expose the wire and insulation, creating the potential for fires or electrical shocks.
-
- **Use only recommended power accessories.** Use of power sources not expressly recommended for this equipment may lead to overheating, distortion of the equipment, fire, electrical shock or other hazards.
-
- **Do not place the batteries near a heat source or expose them to direct flame or heat.** Neither should you immerse it in water. Such exposure may damage the battery and lead to the leakage of corrosive liquids, fire, electrical shock, explosion or serious injury.
-
- **Do not attempt to disassemble, alter or apply heat to the batteries.** There is serious risk of injury due to an explosion. Immediately flush with water any area of the body, including the eyes and mouth, or clothing that comes into contact with the inner contents of a battery.
-
- **Avoid dropping or subjecting the batteries to severe impacts that could damage the casings.** It could lead to leakage and injury.
-

-
- **Do not short-circuit the battery terminals with metallic objects, such as key holders.** It could lead to overheating, burns and other injuries.

 - **Before you discard a battery, cover the terminals with tape or other insulators to prevent direct contact with other objects.** Contact with the metallic components of other materials in waste containers may lead to fire or explosions.

 - **Use only recommended batteries and accessories.** Use of batteries not expressly recommended for this equipment may cause explosions or leaks, resulting in fire, injury and damage to the surroundings.

 - **Use the specified battery charger to charge Battery Pack NB-2LH.** Use of other chargers may lead to overheating, distortion of the equipment, fire or electrical shock.

 - **Disconnect the battery charger and compact power adapter from both the camera and the power outlet after recharging and when they are not in use to avoid fire and other hazards.** Continuous use over a long period may cause a unit to overheat and distort, resulting in fire.

 - **The camera terminal of the battery charger and separately sold compact power adapter are designed for exclusive use with your camera.** Do not use it with other products or batteries. There is a risk of fire and other hazards.

 - **Keep the camera terminal of the battery charger clean, and do not place any metallic objects on it.** There is a risk of fire and other hazards.

 - **Exercise due caution when screwing on the separately sold wide converter, tele-converter and conversion lens adapter.** If they come loose, they may fall from the lens adapter, posing risk of injury from shattered glass.
-

Caution about magnetic fields

Keep objects that are sensitive to magnetic fields (such as credit cards) away from the speaker of the camera (p. 12). Such items may lose data or stop working.



Cautions

-
- **Avoid using, placing or storing the equipment in places subject to strong sunlight or high temperatures, such as the dashboard or trunk (boot) of a car.** Exposure to intense sunlight and heat may cause the batteries to leak, overheat or explode, resulting in fire, burns or other injuries. High temperatures may also cause deformation of the casing. Ensure that there is good ventilation when using the battery charger to charge the batteries.

 - **Do not store the equipment in humid or dusty areas.** Storage in such areas could lead to fire, electrical shock or other damage.
-

-
- **Be careful not to bang the camera or subject it to strong impacts or shocks that could lead to injury or damage the equipment when wearing or holding it by the strap.**

 - **Be careful not to cover the flash with your fingers or clothing when shooting.** The flash may be damaged and emit smoke or noise. In addition, do not touch the surface of the flash after taking several pictures in rapid succession. Either action could result in burns.

 - **Do not operate the flash with dirt, dust or other items stuck to its lens.** The resulting heat build-up could damage the flash.

 - **Ensure that the battery charger and compact power adapter is are plugged into a power outlet of the specified rating, not over the specified rating.** The plug of the battery charger varies according to region.

 - **Do not use the battery charger or compact power adapter if the plug or cable is damaged, or if the plug is not fully inserted into the power outlet.**

 - **Do not allow metal objects (such as pins or keys) or dirt to contact the charger terminals or plug.**

 - **If your camera is used for prolonged periods, the camera body may become warm.** Please take care when operating the camera for an extended period as your hands may experience a burning sensation.
-

Preventing Malfunctions

■ Avoid Strong Magnetic Fields

Never place the camera in close proximity to electric motors or other equipment generating strong electromagnetic fields. Exposure to strong magnetic fields may cause malfunctions or corrupt image and audio data.

■ Avoid Condensation Related Problems

Moving the equipment rapidly between hot and cold temperatures may cause condensation (water droplets) to form on its external and internal surfaces.

You can avoid this by placing the equipment in an airtight, resealable plastic bag and letting it adjust to temperature changes slowly before removing it from the bag.

■If Condensation Forms Inside the Camera

Stop using the camera immediately if you detect condensation. Continued use may damage the equipment.

Remove the memory card and batteries or compact power adapter from the camera and wait until the moisture evaporates completely before resuming use.

■Extended Storage

When not using the camera for extended periods of time, remove the batteries from the camera or battery charger and store the equipment in a safe place.

The date/time settings may be lost after approximately three weeks if you remove the main battery.

Components Guide

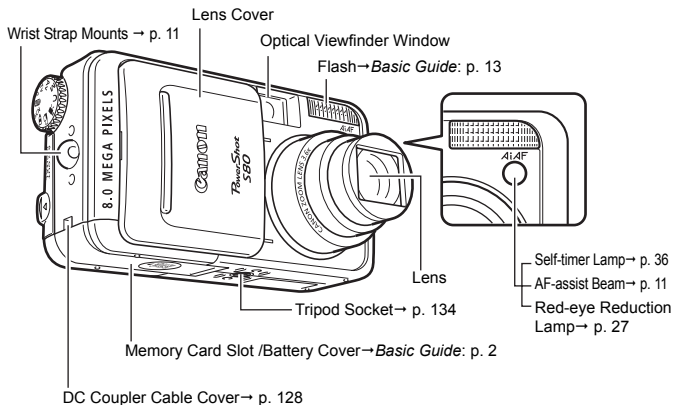

The following cables are used to connect the camera to a computer or printer.

Computer (*Basic Guide*: p. 17)

Interface Cable IFC-400PCU (supplied with the camera)

Direct Print Compatible Printers (Sold Separately)

- Compact Photo Printer (SELPHY CP series):
Interface Cable IFC-400PCU (supplied with the camera).
- Bubble Jet Printers (PIXMA series/SELPHY DS series)
 - *PictBridge* Compliant Printers:
Interface Cable IFC-400PCU (supplied with the camera)
 - *Bubble Jet Direct* Compatible Printers:
Please refer to your Bubble Jet printer user guide.
- *PictBridge* Compliant Non-Canon Printers:
Interface Cable IFC-400PCU (supplied with the camera)

Please refer to the System Map or the Direct Print User Guide supplied with the camera for direct print compatible printer information.

Attaching the Wrist Strap

Attach the strap as illustrated.

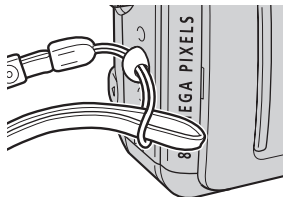

Avoid waving the camera about or catching it on other items when suspending it from the strap.

AF-assist Beam

- The AF-assist Beam will sometimes emit when the shutter button is pressed halfway to assist focusing in certain conditions, e.g., dark conditions.
- The AF-assist Beam can be turned off (p. 27).
For example, if animals are your subject, turn off the beam when shooting in the dark to avoid startling them.
However, please keep in mind the following facts.
 - Turning the AF-assist Beam off when shooting in dark places may make it more difficult for the camera to focus.
 - Even when the AF-assist beam is turned off, the red-eye reduction lamp fires when [Red-eye] is set to [On].

Basic Operations

Operation Panel

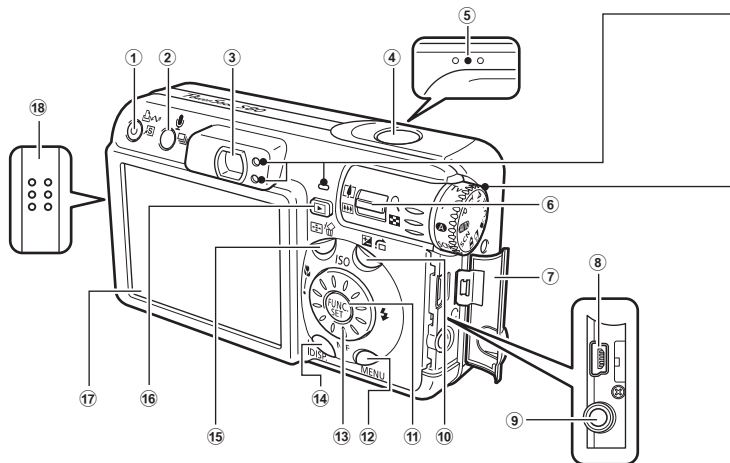

- ① (Print/Share)/ (Shortcut) Button → See *Basic Guide*: p. 17, p. 59
- ② (Continuous)/ (Self-timer)/ (Microphone) Button → p. 40, 36, 97
- ③ Viewfinder → p. 14
- ④ Shutter Button → See *Basic Guide*: p. 8
- ⑤ Microphone → p. 97
- ⑥ Zoom Lever Shooting: (Telephoto)/ (Wide Angle) Button → See *Basic Guide*: p. 12, p. 39
Playback: (Zoom out)/ (Zoom in) Button → p. 88
- ⑦ Terminal Cover
- ⑧ DIGITAL Terminal → See *Basic Guide*: p. 17
- ⑨ A/V OUT (Audio/Video Out) Terminal → p. 112
- ⑩ (Exposure Compensation)/ (Jump) Button → p. 69, 90
- ⑪ FUNC./SET Button → See *Basic Guide*: p. 16, p. 26
- ⑫ MENU Button → See *Basic Guide*: p. 16, p. 26
- ⑬ Multi control dial
 (Up)/ ISO Button → p. 74
 (Left)/ (Macro) Button → See *Basic Guide*: p. 14
 (Down)/ MF Button → p. 64
 (Right)/ (Flash) Button → See *Basic Guide*: p. 13
- ⑭ DISP. Button → p. 15
- ⑮ (AF Frame Selector)/ (Single Image Erase) Button → p. 60, See *Basic Guide*: p. 15
- ⑯ (Playback) Button → See *Basic Guide*: p. 15, p. 93, 99
- ⑰ LCD Monitor → p. 14
- ⑱ Speaker

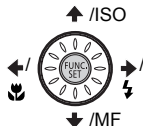

Never rub or press strongly on the LCD monitor. These actions may damage it or lead to other problems.

This indicator lights or blinks during the following operations.

- **Power/Mode Indicator**

- Orange: Shooting mode
- Green: Playback mode/Printer connection
- Yellow: Computer connection

- **Upper Indicator**

- Green: Ready to record
- Blinking Green: Recording to memory card/ Reading memory card/ Erasing from memory

card/Transmitting data (during a computer connection)

- Orange: Ready to record (flash on)
- Blinking Orange: Ready to record (Camera shake warning)

- **Lower Indicator**

- Yellow: Macro mode / Manual focus mode
- Blinking Yellow: Focusing difficulty (although you can press the shutter button, try adjusting the focus manually, p. 62)

Mode Dial

Use the mode dial to switch between the Shooting modes.

- **AUTO : Auto** → See *Basic Guide*:

p. 6

The camera automatically selects settings.

- **Image Zone**

The camera automatically selects settings according to the image composition type.

SCN : Special Scene → See *Basic Guide*: p. 11

 : My Colors → p. 53

 : Stitch Assist → p. 45

 : Movie → p. 41

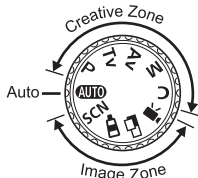

- **Creative Zone** → p. 48

The user selects exposure, aperture or other settings to achieve special effects.

P : Program AE

Tv : Shutter-speed priority AE

Av : Aperture-priority AE

M : Manual Exposure

C : Custom

The following operations are accessible through one easy press of the

①  (Print/Share) button.

- Printing: See the *Direct Print User Guide* (supplied with the camera)
- Downloading images: See *Basic Guide* and *the Software Starter Guide* (supplied with the camera)

The indicator blinks or lights during a printer or computer connection.

- Blue: Ready to print/Ready to transfer images
- Blinking blue: Printing/Transferring

Using the Multi Control Dial

Turning the multi control dial clockwise is equivalent to pressing the **➔** button, while turning the multi control dial counterclockwise is equivalent to pressing the **➤** button (it is equivalent to pressing the **⬆** or **⬇** button with some functions).

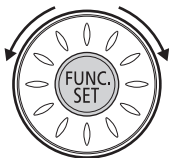

You can perform the following operations when you turn the multi control dial.

- Selecting Special Scene modes (*Basic Guide*: p. 11)
- Erasing the image (*Basic Guide*: p. 15)
- Selecting the FUNC. menu item (*Basic Guide*: p. 16)
- Selecting the Menu item (*Basic Guide*: p. 16)
- Selecting the time zone (p. 24)
- Selecting the movie mode (p. 41)
- Exposure shift when shooting movie (p. 43)
- Selecting the Stitch Assist mode (p. 45)
- Selecting a shutter speed in Tv (p. 50, 52)
- Selecting an aperture value in Av (p. 51, 52)
- Selecting the shutter speed and the aperture value in M (p. 51, 52)
- Selecting the AF Frame (p. 61)
- Adjusting the focus in manual focus mode (p. 64)
- Program Shift (p. 66)
- Adjusting the exposure (p. 69)
- Selecting the image in Playback mode (p. 88, 89, 90, 91)
- Operating when viewing/editing movies (p. 94, 95, 96)
- Operating the sound memos (p. 97)
- Operating DPOF (p. 106, 108, 110)
- Registering the My Camera contents (p. 113, 114)

Using the Viewfinder

Setting the LCD monitor to Off (p. 15) and using the optical viewfinder can help conserve power while shooting.

- The viewfinder has a field of vision of approximately 80% of the actual shooting image.

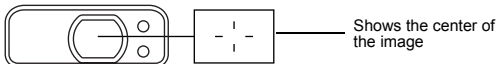



Image Seen in Viewfinder vs. Recorded Image

Please note that the actual image may differ from the image seen in the optical viewfinder due to the physical separation between the viewfinder and lens. This is called the parallax phenomenon and is more noticeable the closer the subject is to the lens. In some cases, portions of images shot up close that appear in the viewfinder will not appear in the recorded image. Please use the LCD monitor to shoot images up close.

Shooting with an Off-Center AF Frame Selected

You should always use the LCD monitor to compose images when you have selected an off-center AF frame. When setting the AF frame to the desired position to shoot an image, please use the LCD monitor (See *Selecting an AF Frame* → p. 60)

Using the LCD Monitor

Pressing the **DISP.** button switches the display mode.

Shooting Mode

Press the **DISP.** button.

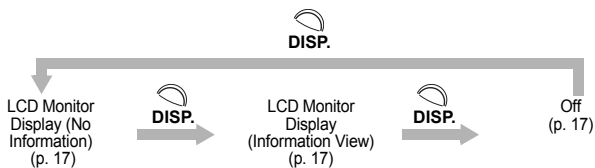

Playback Mode

Press the **DISP.** button.

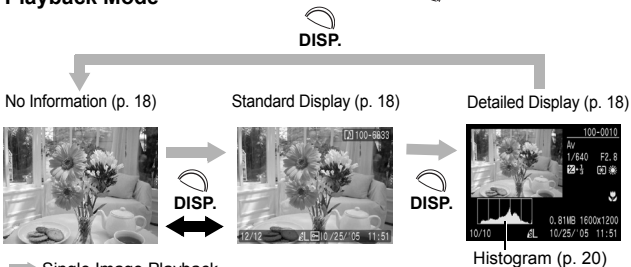

→ Single Image Playback

↔ Index Playback

LCD Monitor Brightness

Changing the brightness of the LCD monitor

The brightness of the LCD monitor can be changed in the following two ways.

- Changing Settings Using the Set up Menu (p. 29)
- Changing Settings Using the **DISP.** Button (Quick-bright LCD Function)
Pressing the **DISP.** button for at least 1 second switches the brightness to the highest setting*.
 - Pressing it again for at least 1 second restores it to the original setting.
 - If you set the brightness to the highest setting using this method and turn the camera power off, the brightness setting will revert to the value set in the Set up menu.
 - * If the brightness setting is already at the maximum in the [Setup] menu, you cannot modify the brightness.

Night Display

When shooting in dark conditions, the camera automatically brightens the LCD monitor to suit the brightness of the subject*, making it easier to frame the subject.

* Noise will appear, and the movements of the subject will appear irregular in the LCD monitor. The brightness of the image displayed in the monitor, and the brightness of the actual image recorded will be different (this function cannot be disabled).

Display Contents

Shooting Information (Shooting Mode)

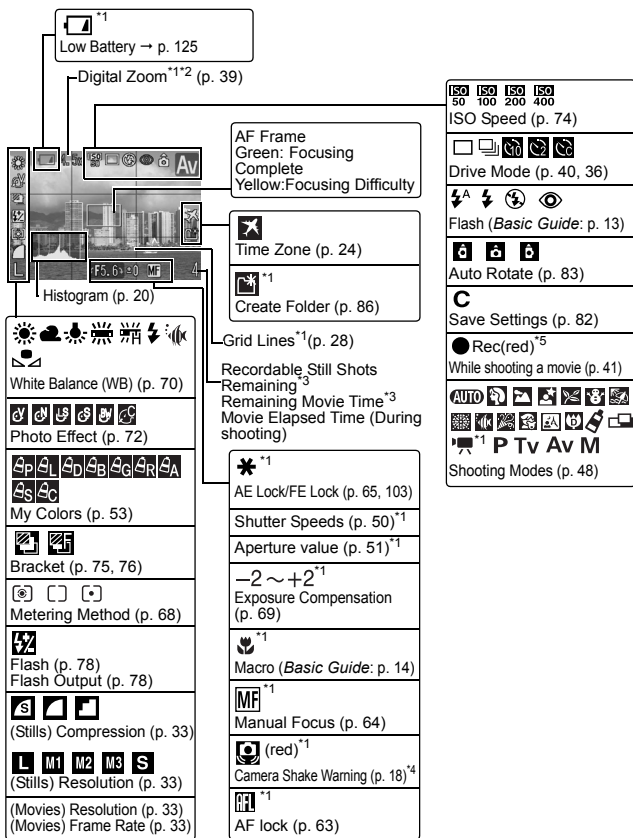

- *1 This is displayed in the no information display mode.
- *2 Zoom powers reflect the combined optical and digital zoom effects. Optical zoom is displayed in white up to "3.6x", the optical telephoto limit. It does not appear when "digital zoom" is disabled. When digital zoom is enabled, the zoom value is displayed in blue.
- *3 "0" appears when no more recording space is available for either still images at the current resolution or remaining movie time. When both recording capacities are full, the "Memory card full" message appears.
- *4 This is not normally displayed. It appears when camera shake occurs when the shutter button is pressed lightly (halfway).
- *5 Appears only when shooting movies.



- ◆ Even in the no information display mode, shooting information appears for approximately 6 seconds when changing shooting settings etc. (shooting information may not appear depending on the camera settings at that time).
- ◆ When there is insufficient illumination the  (camera shake warning) icon appears in red on the LCD monitor and the lower Indicator blinks in orange while the camera is preparing to shoot. Use one of the following shooting methods.
 - Set the flash settings to enable automatic or normal firing
 - Fix the camera to a tripod
 - Raise the ISO speed

Playback Information- Mode

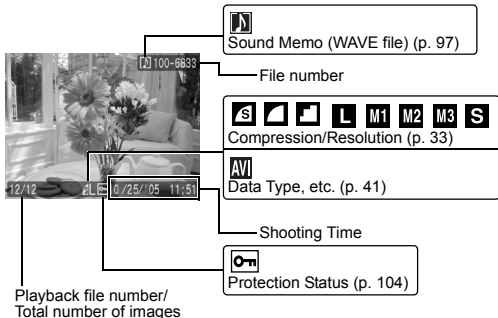

Playback Information-Detailed (Playback Mode)

The screenshot shows a camera's playback information screen. At the top left, a histogram is displayed with a label 'Histogram (p. 20)'. Below it, the file number '100-0010' is shown. The main image area shows a still image of a vase with flowers. Below the image, the file size '0.81MB' and resolution '1600x1200' are displayed. At the bottom left, shooting resolution and time information are shown: '10/10', '10/25/05', and '10:00'. On the right side, a grid of icons and text provides detailed settings for various camera functions.

ISO Speed (p. 74)	White Balance (WB) (p. 71)
Macro (<i>Basic Guide</i> : p. 14)	Flash Adjust (p. 77)
Shooting Modes (<i>Basic Guide</i> : p. 10, p. 48)	Flash Output (p. 77)
Shutter speed (p. 50)	Metering Method (p. 68)
Aperture value (p. 51)	Photo Effect (p. 72)
Resolution (Movies) (p. 33)	My Colors (p. 53)
Frame Rate (p. 33)	Manual Focus (p. 64)
Exposure Compensation (p. 72)	

The following information may also be displayed with some images.

	A sound file in a format other than the WAVE format is attached or the file format is not recognized.
	JPEG image with format not conforming to Design rule for Camera File System Standards (p. 137)
	RAW image
	Unrecognized data type



- ◆ While a recorded image is displayed on the LCD monitor, you can check the exposure with the graph (see *Histogram Function* (p. 20)) that shows the distribution of the brightness data. If the exposure requires adjustment, set the exposure compensation (p. 69) and reshoot. Press the **DISP.** button if the histogram and other information are not shown.
- ◆ Please note that image information recorded by this camera may not display correctly on other cameras and image information recorded by other cameras may not display correctly on this camera.



Overexposure Warning

In the following cases, overexposed portions of the image blink.

- ◆ When reviewing an image right after shooting in the LCD monitor (information view)
- ◆ In the detailed display mode of the Playback mode

Histogram Function

The histogram is a graph that allows you to judge the brightness of the image while shooting. In **P**, **Tv**, **Av** and **M** modes, the greater the bias toward the left in the graph, the darker the image. The greater the bias toward the right, the brighter the image.

If the image is too dark, adjust the exposure compensation to a positive value (p. 69), set a low shutter speed, or set a low aperture value.

Similarly, adjust the exposure compensation to a negative value, set a fast shutter speed, or set a large aperture value if the image is too bright.

Brightness of shot images can be judged in playback mode.



Dark Image



Balanced Image



Bright Image

1 On the [] (Rec.) menu, select [Histogram], and then use the ← or → button to select [On].

- See *Selecting menus and settings* (Basic Guide: p. 16)
- On:** The histogram is displayed.
- Off:** The histogram is not displayed.
- Set the LCD monitor display to Information View first. (p. 17)

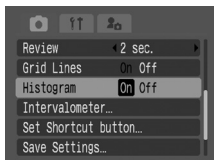

2 Press the MENU button.

Changing the Review Duration

1 Select [Review] from the [(Rec.)] menu and use the ← or → button to select the duration setting.

- See *Selecting Menus and Settings (Basic Guide: p. 16)*
- Settings can be made by turning the multi control dial.

Off: Images do not display.

2 to 10 sec.: Images appear for the time selected even if the shutter button is released.

Hold: The image is displayed until the shutter button is pressed again halfway.

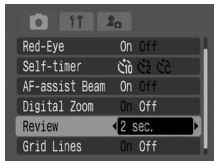

2 Press the MENU button.

You can shoot the next image while a menu is still displayed.

Power Saving Function

This camera is equipped with a power saving function. Depending on the power saving setting, the camera may power down or the LCD monitor may go off automatically.

Auto Power Down

- [On]:
- Shooting mode: Powers down approximately 3 minutes after the last time a control is accessed on the camera. The LCD monitor automatically shuts off approximately 1 minute* after the last time a camera control is accessed even if [Auto Power Down] is set to [Off]. In this situation, press a button or turn the camera lengthwise and the LCD monitor reacts accordingly.
 - * This time can be changed.
 - Playback mode: Powers down approximately 5 minutes after the last time a control is accessed on the camera.
 - Printer Connection mode: Powers down approximately 5 minutes after the last time a control is accessed on the camera.

[Off]: The power saving function does not activate.

Display Off (Shooting Mode Only)

The LCD monitor shuts off after a specified period of time elapses and no camera control is accessed. The following time settings can be selected: 10 sec./20 sec./30 sec./1 min.* /2 min./3 min.

* Default setting

When the Auto Power Down Function Activates

Turn the power on again.

Playback/Printer Connection mode: Press the  button again to power the camera.

When the Display Off Function Activates

The LCD monitor display turns back on if any button is pressed.



- ◆ Please note that the camera continues to consume a minimal amount of power even when the power saving function shuts it down.
- ◆ The power saving function is disabled while a slide show plays on the camera or during a computer connection (*Basic Guide*: p. 21, p. 99).

1 Select [Power Saving] in the [MENU] (Set up) menu and press the FUNC./SET button.

See *Selecting Menus and Settings* (*Basic Guide*: p. 16).

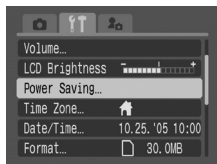

2 Use the or button to select [Auto Power Down] and select [On] or [Off] with the or button.

Settings can be made by turning the multi control dial.

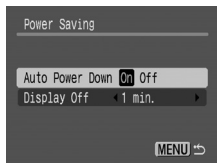

3 Use the or to select [Display Off] and select the desired time with the or button.

Settings can be made by turning the multi control dial.

4 Press the Menu button.

Formatting a Memory Card

You should always format a new memory card or one from which you wish to erase all images and other data.

 Please note that formatting (initializing) a memory card erases all data, including protected images and other file types.

- 1 Use the **↑** or **↓** button to select **[Format]** in the **[⏏ (Set up)]** menu, then press the **FUNC./SET** button.

See *Selecting Menus and Settings (Basic Guide: p. 16)*.



- 2 Use the **←** or **→** button to select **[OK]**, then press the **FUNC./SET** button.

The upper indicator blinks green, and formatting starts. Wait until the indicator goes off.

- Normal formatting begins.
- To perform a low level format, use the **↑** or **↓** button to select **[Low Level Format]** and the **←** or **→** button to add a check mark. Settings can be made by turning the multi control dial.
- To cancel instead of formatting, select **[Cancel]** and press the **FUNC./SET** button.
- You can stop formatting a card when **[Low Level Format]** is selected by pressing the **FUNC./SET** button. You can still use a card without problem when formatting is halted, but all data will be erased.
- The capacity of the memory card displayed after formatting will be less than the rated capacity of the memory card. This is not a malfunction of the memory card or camera.

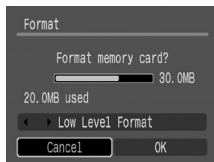
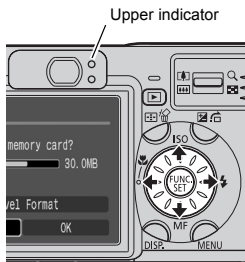

3 Press the MENU button.



◆ Low Level Format

You should select the Low Level Format option if you suspect the read/write speed of a memory card has dropped. A low level format may require 2 to 3 minutes with some memory cards.

- ◆ If the camera does not work properly, the inserted memory card may be malfunctioning. Reformatting the memory card may solve the problem.
- ◆ When a non-Canon brand memory card is malfunctioning, reformatting it may solve the problem.
- ◆ Memory cards formatted in other cameras, computers, or peripheral devices may not operate correctly in this camera. When that happens, reformat the memory card with this camera. If formatting in the camera does not work properly, turn the camera off and re-insert the memory card. Then turn the camera back on and format again.

Setting the World Clock

When traveling abroad, you can record images with local dates and times simply by switching the time zone setting if you pre-register the destination time zones. You can enjoy the convenience of not having to switch the Date/Time settings.

It is necessary to first set the home time zone.

1 Select [Time Zone] in the [] (Set up) menu and press the FUNC./SET button.

See *Selecting menus and settings (Basic Guide: p. 16)*

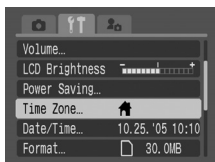

- 2** With the **↑** or **↓** button, select **🏠** (Home), and then press the **FUNC./SET** button.



- 3** With the **←** or **→** button, select a home time zone from the map, and then press the **FUNC./SET** button.

- You can select a home time zone by turning the multi control dial.
- The select area time is taken as the shooting time.
- To make the correction for daylight saving time, use the **↑** or **↓** button to display the daylight saving time icon (☀️). The current time is advanced one hour.

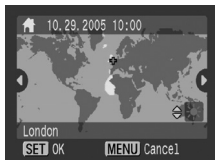

- 4** Use the **↑** or **↓** button to select **🌐** (World), press the **FUNC./SET** button, and then select a destination time zone as same as step 3.

Switching to the Destination Time Zone

- 1** On the [**ⓘ**] (Setup) menu, select [Time Zone] and then press the **FUNC./SET** button.

See *Selecting menus and settings* (Basic Guide: p. 16)

- 2** Use the **←** or **→** button to select **🌐** (World), and then press the **MENU** button.

- You can modify the destination time zone with the **FUNC./SET** button.



If you do not select a home time zone beforehand, you cannot configure the destination time.



Changing the time of the destination time zone's date/time will automatically change the home time zone's data/time.

Menu List

Configure various convenient shooting and playback functions.

- See *Selecting Menus and Settings (Basic Guide: p. 16)*.



- ◆ Some menu items may not be available for selection according to the shooting mode (p. 160).
- ◆ You can apply a desired image and sound to **[P2]** and **[P3]** in the My Camera menu. For details, see *Registering the My Camera Settings* (p. 114) or the *Software Starter Guide*.
- ◆ Camera settings can be reset to the default values (p. 32).

FUNC. Menu

White Balance (**[AWB]**) → p. 70



My Colors (**[SP]**) → p. 53

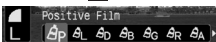

Photo Effect (**[OFF]**) → p. 72



Bracket (**[BKT]**) → p. 75, 76



Flash Exposure Compensation (±0) → p. 77



Flash Output → p. 77

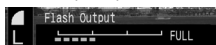

Evaluative (**[E]**) → p. 69

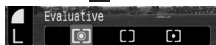

Compression (**[C]**) → p. 33



Resolution (L) → p. 33







Resolution: Movie (**[30]**) → p. 33



Frame Rate: Movie (**[640]**) → p. 33





() items in parentheses show default settings.

 Rec. Menu		
Menu Item	Available Settings	Reference Page
Flash Sync	Sets the timing at which the flash fires. 1st-curtain*/2nd-curtain	p. 79
Slow Synchro	Sets whether or not the flash will fire with a slow shutter speed. On/Off*	p. 35
Flash Adjust	Sets whether or not the flash is adjusted automatically. Auto*/Manual	p. 77
Red-eye	Sets whether or not the red-eye reduction lamp fires when the flash fires. On*/Off	p. 34
Self-timer	Sets the duration before the self-timer releases the shutter once the shutter button is pressed.  (10 sec.)* /  (2 sec.)  (Custom)	p. 36
Spot AE Point	Sets the option of [Spot AE Point] (one of the metering modes) to Center (the AE point is fixed to the center) or AE Point (the AE point corresponds to the AF point). Center*/AF Point	p. 68
Safety Shift	When enabled, this function automatically adjusts exposure settings in the Av or Tv mode if they do not suit current exposure requirements when the shutter button is pressed halfway. On/Off*	p. 52
MF-Point Zoom	Sets whether or not the focusing point is magnified when using the manual focus. On*/Off	p. 64
AF-assist Beam	Enables AF-assist beam firing during auto focusing, if necessary. On*/Off	p. 11
Digital Zoom	Sets the digital zoom to on or off. Can be used while shooting movies, however the default setting is [On]. On/Off*	p. 38
Review	Sets the duration images display on the LCD monitor after the shutter button is released. Off / 2* to 10 sec. / Hold	<i>Basic Guide:</i> p. 9

Menu Item	Available Settings	Reference Page
Save Original	Select whether to store the original image when shooting a still image with My Colors. On/Off*	p. 54
Grid Lines	You can display grid lines (split into nine) to make it easier to judge the horizontal and vertical alignment of a photographic subject and to make composition easier. The lines will not be recorded in the images. On/Off*	p. 17
Histogram	Sets whether to display a histogram to help you verify the image brightness. On*/Off	p. 20
Intervalometer	Shoots automatically at set intervals. 1* to 60 min. 2* to 100 shots	p. 80
Set Shortcut button	Selects functions to be registered on the  (Shortcut) button.	p. 59
Save Settings	Saves settings selected in the Rec. menu and the function menu to the mode dial's C mode.	p. 82

* Default setting

Play Menu

Menu Item	Available Settings	Reference Page
Protect	Protects images from accidental erasure.	p. 104
Rotate	Rotates images clockwise 90° or 270° in the display.	p. 92
Erase all	Deletes all images from a memory card (except for protected images).	p. 105
Slide Show	Plays images automatically one after the other.	p. 99
Print Order	Sets the images that will be printed on a direct print compatible printer or at a photo lab service, the number of copies and other parameters.	p. 106
Transfer Order	Specifies settings for images before downloading to a computer.	p. 106
Transition	Sets whether to apply effects during playback. Off  * / 	p. 93

⏏ Set up Menu





Menu Item	Available Settings	Reference Page
Mute	<p>Set [On] to mute the start-up sound, operation sound, self-timer sound and shutter sound all at once.</p> <ul style="list-style-type: none"> ● If you set [Mute] to [On], no sound will be heard even when any sound item in the My Camera menu is set to 1, 2, 3 (On). ● However, a warning will still sound when the memory card slot cover is opened while an image is being written to the memory card even if the [Mute] function is set to [On]. <p style="text-align: center;">On/Off*</p>	-
Volume	Adjusts the volume of camera operations.	-
① Start-up Vol.	Adjusts the volume of the start-up sound when the camera power is turned on.	<i>Basic Guide: p. 4</i>
② Operation Vol.	Adjusts the volume of the operation sound that beeps when any button other than the shutter button is pressed.	-
③ Self-timer Vol.	Adjusts the volume of the self-timer sound informing you that the photo will be taken in 2 seconds.	p. 36
④ Shutter Vol.	Adjusts the volume of the sound played when the shutter releases. The shutter sound does not play when a movie is recording.	<i>Basic Guide: p. 8</i>
⑤ Playback Vol.	During movie playback, adjusts the volume of sound memos.	p. 94, 97
Settings of Above Items (① - ⑤)	Off	-
LCD Brightness	<p>Use the ← or → button to adjust the brightness of the LCD monitor.</p> <p>Use the FUNC./SET button to return to the configuration menu. When using the LCD monitor, you can adjust the image brightness while looking at it.</p> <p style="text-align: center;">-7 to 0* to +7</p>	-

Menu Item	Available Settings	Reference Page
Power Saving	Sets whether or not the camera automatically powers down or the LCD monitor (or viewfinder) goes off after a specified period of time elapses without camera operation. Auto Power Down <p style="text-align: center;">On*/Off</p> Display Off 10 sec./20 sec./30sec./1 min.* /2 min./3 min.	p. 22
Time Zone	Sets your home or travel destination time. Time setup <p style="text-align: center;">Home*/World</p> Area select <p style="text-align: center;">World 32 areas</p> Daylight saving time <p style="text-align: center;">On/Off*</p>	p. 24
Date/Time	Sets the date and time and the date format.	<i>Basic Guide</i> : p. 6
Format	Formats (initializes) memory cards.	p. 23
File Numbering	Sets how file numbers are assigned to images when new memory cards are inserted. <p style="text-align: center;">Auto Reset/Continuous*</p>	p. 84
Create Folder	Sets the timing with which to create folders. <p style="text-align: center;">Create New Folder/Auto Create (Daily, Monday-Sunday (Weekly), Monthly)/Time</p>	p. 86
Auto Rotate (In Shooting mode) <hr style="border-top: 1px dashed black;"/> Auto Rotate (In Shooting mode)	Sets whether the image shot is rotated automatically when it is taken vertically. <p style="text-align: center;">On*/Off</p> <hr style="border-top: 1px dashed black;"/> Sets whether the image shot is automatically rotated and displayed on the LCD monitor to match the direction of the camera. <p style="text-align: center;">On*/Off</p>	p. 83
Distance Units	Sets the format of the displayed distance units of the MF indicator. <p style="text-align: center;">m/cm* or ft/in</p>	-

Menu Item	Available Settings	Reference Page
Language	<p>Sets the language used in the menus and messages on the LCD monitor.</p> <ul style="list-style-type: none"> • English* • Deutsch (German) • Français (French) • Nederlands (Dutch) • Dansk (Danish) • Suomi (Finnish) • Italiano (Italian) • Norsk (Norwegian) • Svenska (Swedish) • Español (Spanish) • 简体中文 (Simplified Chinese) • Русский (Russian) • Português (Portuguese) • Ελληνικά (Greek) • Polski (Polish) • Čeština (Czech) • Magyar (Hungarian) • Türkçe (Turkish) • 繁體中文 (Traditional Chinese) • 한국어 (Korean) • ภาษาไทย (Thai) • 日本語 (Japanese) <p>You can change the language during image playback by holding the FUNC./SET button and pressing the MENU button. (Except when the camera is connected to a printer)</p>	<p><i>Basic Guide: p. 7</i></p>
Video System	<p>Sets the video output signal standard.</p> <p style="text-align: center;">NTSC/PAL</p>	p. 112
Reset All	Resets the camera to its default configuration	p. 32

* Default setting

My Camera Menu

Menu Item	Available Settings	Reference Page
Theme	Selects a common theme for each My Camera settings item.	p. 113
Start-up Image	Sets the start-up image when you turn on the camera.	p. 114
Start-up Sound	Sets the start-up sound when you turn on the camera.	p. 114
Operation Sound	Sets the sound when the multi control dial or any button other than the shutter button is pressed.	p. 114
Self-timer Sound	Sets the sound informing you that the photo will be taken in 2 seconds.	p. 114
Shutter Sound	Sets the sound played when the shutter button is pressed. The shutter sound does not play when a movie is recording.	p. 114
My Camera Menu Contents	 (Off) /  * /  / 	-

* Default setting

Resetting Settings to Their Default Values

You can reset the menu and button settings to the default settings in one operation.

1 Select [Reset All] in the [(Set up)] menu and press the FUNC./SET button.

The message "Reset settings to default?" appears on the LCD monitor.

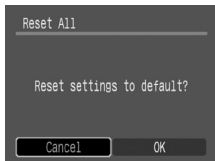

2 Use the or button to select [OK], then press the FUNC./SET button.

Resetting starts.

- The normal screen resumes when resetting is complete.
- To cancel resetting, select [Cancel] instead of [OK].
- Settings can be made by turning the multi control dial.



- The following settings cannot be reset to default:
 - [Date/Time], [Language] and [Time Zone] options in the [ (Set up)] menu
 - [Video System] settings (p. 31)
 - Colors specified in the Color Accent or Color Swap modes
 - **C** Mode Settings
 - White balance data set with the custom white balance function (p. 71)
 - Newly registered My Camera settings
- Settings cannot be reset when the camera is connected to a computer or printer.



When the camera is in Shooting mode and the mode dial is set to **C**, only the **C** mode settings revert to defaults.

Changing Resolution/Compression Settings





Mode Dial

AUTO SCN   **P** Tv Av M

You can change the resolution, compression (still images) and frame rate (movies, p. 41) settings to suit the purpose of the image you are about to shoot.

Still Images

Resolution		Purpose
Display	Pixels	
L (Large)	3264 × 2448	 <ul style="list-style-type: none"> ● Print larger than A3 size* prints 297 x 420 mm (11.7 x 16.5 in.) ● Print A3 size prints* 297 x 420 mm (11.7 x 16.5 in.) ● Print A4 size* prints 210 x 297 mm (8.3 x 11.7 in.) ● Print letter size* prints 216 x 279 mm (8.5 x 11 in.) ● Print L size prints 89 x 119 mm (3.5 x 4.7 in.) ● Send images as e-mail attachments ● Shoot more images
M1 (Medium 1)	2592 × 1944	
M2 (Medium 2)	2048 × 1536	
M3 (Medium 2)	1600 × 1200	
S (Small)	640 × 480	



Compression		Purpose
 Superfine	 High Quality Normal	
 Fine		Shoot normal quality images
 Normal		Shoot more images

Movies

Resolution	Frame Rate	Image Quality	Smoothness	Recording Time	Purpose
1024 × 768	15 frames/sec.	High Quality	Normal	 Short Long	When viewing movies on a computer screen at a large size.
640 × 480	30 frames/sec.	High Quality	Full-motion		Shoot higher quality movies
640 × 480	15 frames/sec.	High Quality	Normal		Normal shooting with resolution as priority
320 × 240	30 frames/sec.	Normal	Full-motion		Normal quality with smoothness as priority
320 × 240	15 frames/sec.	Normal	Normal		Shoot longer movies
160 × 120	15 frames/sec.	Normal	Normal	Up to 3 min.	Send movies as e-mail attachments

1 Press the FUNC./SET button.



2 Use the \uparrow or \downarrow button to select []* (Compression), and then the \leftarrow or \rightarrow button to set the compression rate.

- You can shoot the image right after selecting settings by pressing the shutter button. This screen will appear again once the image or movie is shot.
- For movies ( , ), select the frame rate.
- Image file size (estimated) (p. 141)
- Types of memory card and number of shots remaining (p. 140)
- Settings can be made by turning the multi control dial.

* Current settings will display.



3 Use \uparrow or \downarrow button to select []* (3264 x 2448), then use the \leftarrow or \rightarrow button to select the resolution you wish to set.

- For movies ( , ), select []* (640 x 480, 30 fps).
- Settings can be made by turning the multi control dial.

* The current setting is displayed.



Number of shots remaining _____
In the case of a movie clip, displays the remaining shooting time (in seconds).

4 Press the FUNC./SET button and shoot the image.

Setting the Red-eye Reduction Function

Mode Dial



*  (Fireworks) and  (Digital Macro) modes cannot be set.

The red-eye reduction lamp fires when the flash is used in dark areas. This reduces light reflecting back from the eyes and making them appear red.

1 Select [Red-Eye] from the [Rec.] menu.

See *Selecting Menus and Settings* (Basic Guide: p. 16)

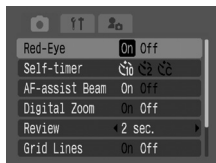

2 Use the ← or → button to select [On] and press the MENU button.

- appears on the LCD monitor if it is set to Information View display.
- Settings can be made by turning the multi control dial.

Red-Eye Reduction

Light reflecting back from eyes can make them appear red when the flash is used in dark areas. Under these conditions, use the red-eye reduction mode. For this mode to be effective, the subject must be looking right at the red-eye reduction lamp. Try asking them to look directly at the lamp. Even better results can be obtained by shooting with the lens set to a wide angle, increasing the lighting in indoor settings or moving closer to the subject.

Setting the Slow Synchro

Mode Dial



The flash timing is adjusted to slow shutter speeds. This reduces the chance that only the background will appear dark when a person is shot against a twilight background or night scene, or when an interior shot is taken.

1 Select [Slow Synchro] from the [Rec.] menu.

See *Selecting Menus and Settings* (Basic Guide: p. 16)

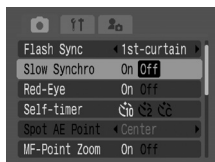

2 Use the **←** or **→** button to select [On] and press the **MENU** button.

Settings can be made by turning the multi control dial.

! When shooting with a high ISO speed and using the built-in flash, there is more of a chance of overexposure the closer you are to the subject.



- ◆ The fastest shutter speed for flash synchronization is 1/250 second. The camera automatically resets the shutter speed to 1/250 second if a faster speed is selected.
- ◆ When shooting with [Slow Synchro] set to [On], camera shake may become a factor. Use of a tripod is recommended.
- ◆ In the case of My Colors, **P**, **Tv**, **Av**, and **M**, the flash mode setting is not canceled even when the camera is turned off.

Using the Self-timer

Mode Dial

AUTO **SCN** **P** **Tv** **Av** **M**

1 Press button.

The current setting is displayed.



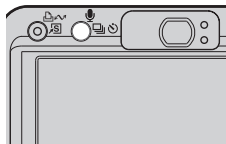

- Pressing the button cycles between settings.



- You can switch between the (10 sec.), (2 sec.) and (Custom Timer) options with the [Self timer] option in the [(Rec.)] menu (p. 27).
- When the self-timer is set to , the shutter activates 10 seconds after, and when the self-timer is set to , the shutter activates 2 seconds after, the shutter button is pressed fully. With the option, the specified number of shots are taken after the specified delay.

* May not be displayed, depending on mode.

2 Check that , or is displayed and shoot the image.



- When  is selected, the self-timer sounds and the self-timer lamp starts blinking when the shutter button is pressed all the way. The blinking gets faster approximately 2 seconds before the shutter trips.
- When  is selected, the self-timer lamp blinks fast from the beginning, and the shutter trips after approximately 2 seconds.
- When  is selected and the shutter button is pressed all the way, the custom self-timer behaves as follows according to the preset delay:
 - 0 seconds: The shutter trips immediately.
 - 1 second: A beep sounds and the self-timer lamp blinks fast until the shutter trips approximately 1 second later.
 - 2 to 30 seconds: A beep sounds and the self-timer lamp starts blinking. Approximately 2 seconds before the shot, the self-timer sounds (if customized), and the blinking gets faster.
- You can change the self-timer sound by changing the [Self-Timer Sound] setting in the [ (My Camera)] menu (p. 29).
- When using red-eye reduction, the self-timer lamp will blink and then stay lit for the last 2 seconds.



Changing the Delay Time and Number of Shots (Custom Timer)

You can set the self-timer delay and number of shots to be taken.

1 In the [(Rec.)] menu, select [Self-timer].

- See *Selecting Menus and Settings* (Basic Guide: p. 16)
- These settings are not available when  (My Colors),  (Stitch Assist) or  (Movie) is displayed.

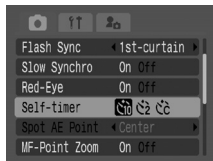

2 Use the **←** or **→** button to select and press the **FUNC./SET** button.

Settings can be made by turning the multi control dial.

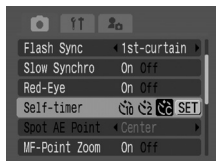
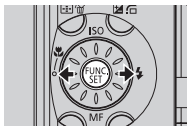

3 Select the timer delay and number of shots.

- Use the **↑** or **↓** button to select the [Delay] or [Shots].
- Use the **←** or **→** button to select the timer delay settings (0 to 10, 15, 20 or 30 seconds) or No. of shots (1 to 10).
- Settings can be made by turning the multi control dial.

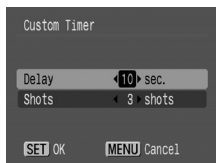

4 Press the **FUNC./SET** button.



When set for multiple shots, shooting automatically stops when the memory card is full.



When set for multiple shots, exposure and white balance are set and locked with the first shot, and shooting occurs at the same speed as for continuous shooting (p. 40). Between shots, the beep sounds and the self-timer lamp blinks. Shooting may slow down while the flash is charging and when internal memory becomes full.

Using the Digital Zoom

Mode Dial

AUTO SCN * **P** Tv Av M

*You can only make this setting when the display is standard.

With the combined optical and digital zoom functions, images can be zoomed as follows:

4.5x, 5.7x, 7.3x, 9.2x, 11x and 14x (except for digital macro).



- ◆ Images become coarser the more they are digitally zoomed.
- ◆ To zoom back out, turn the zoom lever toward

1 Select [Digital Zoom] from the [(Rec.)] menu, select [On] with the or button, then press the MENU button.

- See *Selecting Menus and Settings* (Basic Guide: p. 16)
- Settings can be made by turning the multi control dial.

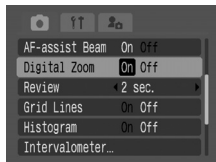

2 Push the zoom lever toward and shoot the image.

When you zoom in with optical zoom, zooming stops when the lens reaches the maximum optical telephoto setting (while shooting still images). To activate digital zoom and continue zooming in, push the zoom lever toward once more.



Continuous Shooting

Mode Dial

SCN **P** Tv Av M

Use this mode to shoot successive frames while the shutter button is fully pressed. Recording ceases when the shutter button is released. Smooth continuous shooting at a constant interval can proceed until the memory is full (p. 140).^{*1*2}

1 Press the  button to display .

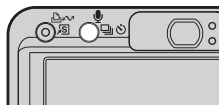

2 Press the shutter button halfway to lock the focus.

3 Press the shutter button all the way to shoot.



- Recording ceases when the shutter button is released.
- Continuous shooting has a speed of approx. 1.8 shots/sec.^{*2*3}

*1 The recommended super high-speed SDC-512MSH memory card (sold separately) is used and formatted with a low level format (p. 23), and a resolution and compression combination other than **L** and **S** is selected. Even if continuous shooting suddenly stops, the memory card may not be full.

*2 This figure reflects standard shooting criteria established by Canon. Actual figures may vary according to the subject and shooting conditions.

*3 Large/Fine

To Cancel Continuous Shooting

Press the  button twice to display .



















To enhance the continuous shooting performance when you suspect the speed has dropped, you are recommended to format the memory card in the camera (Low Level Format) after you save all its images to your computer.



- ◆ The interval between shots may lengthen when the camera's internal memory fills.
- ◆ If the flash is firing, the interval between shots will lengthen to accommodate the flash's charging requirements.

Shooting a Movie

The following four movie modes are available.

	Standard	<p>You can select the resolution and frame rate^{*1} yourself and record until the memory card is full^{*2}. The digital zoom can be used while shooting in this mode (p. 39).</p> <ul style="list-style-type: none">● Resolution:  (640 x 480),  (320 x 240)● Frame Rate:  (30 frames/sec.),  (15 frames/sec.)● Maximum Size: 1 GB/movie
	High Resolution	<p>Use this mode when viewing movies on a computer screen at a large size.</p> <ul style="list-style-type: none">● Resolution:  (1024 x 768)● Frame Rate:  (15 frames/sec.)● Maximum Size: 1 GB/movie
	Compact	<p>Since the resolution is low, this mode is convenient for sending movies as e-mail attachments or when the memory card capacity is low.</p> <ul style="list-style-type: none">● Resolution:  (160 x 120)● Frame Rate:  (15 frames/sec.)● Max. Clip Length^{*3}: 3 minutes
	My Colors	<p>You can change image colors and then shoot (p. 53). As with the Standard mode, you can also select the resolution and frame rate^{*1} yourself and record until the memory card is full^{*2}.</p> <ul style="list-style-type: none">● Resolution:  (640 x 480),  (320 x 240)● Frame Rate:  (30 frames/sec.),  (15 frames/sec.)● Maximum Size: 1 GB/movie

*1 The frame rate indicates the number of frames recorded/replayed in one second. The higher the frame rate, the smoother the motion.

*2 When a super high-speed memory card is used, such as the recommended SDC-512MSH model.



*3 The recording time will vary according to the capacity of the memory card you use. See p. 140 for details.

1 Turn the mode dial to .

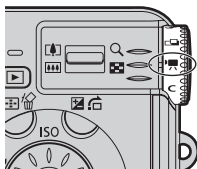
The maximum recording time (in seconds) is displayed.



2 Turn the multi control dial to select a movie mode.

- See *Selecting Menus and Settings* (Basic Guide: p. 16).
- You can shoot the image right after selecting settings by pressing the shutter button. The menu displays again after the shot, allowing you to change the settings easily.
- In  or  mode, you can change the resolution (p. 33) and frame rate (p. 33).



3 Press the shutter button halfway.

The camera will automatically set the exposure, focus and white balance.

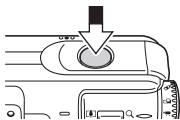

4 Press the shutter button fully.

- Shooting and sound recording starts simultaneously.
- During shooting the recording time and the [●(Rec.)] appear on the LCD monitor.
- When  displays, you can use the digital zoom.

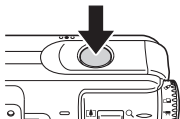

5 Press the shutter fully again to stop recording.

- The maximum recording time may vary with the subject and shooting conditions. Just before the maximum is reached, or just before the memory card fills to capacity, the counter at the bottom right of the LCD monitor will display in red and recording will stop automatically after approximately 10 seconds (excluding  (Compact)).

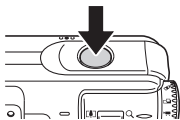





- The recording time may not display properly during shooting or filming may stop unexpectedly with the following types of memory cards.
 - Slow recording cards
 - Cards formatted on a different camera or a computer
 - Cards which have had images recorded and erased repeatedly
- Although the recording time may not display properly during shooting, the movie will be recorded correctly on the memory card. Recording time will display properly if you format the memory card in this camera (excluding slow recording memory cards).
- You are recommended to use a memory card that has been formatted in your camera to shoot movies (p. 23). The card supplied with the camera may be used without further formatting.
- Be careful not to touch the microphone while shooting.
- Do not press buttons other than the shutter button while filming to avoid inadvertent recording of the operation sounds.
- If the upper indicator blinks green after a shot, this indicates that the movie is being written to the memory card. You cannot shoot again until the blinking stops.
- You may experience frame dropping and audio breakup when playing back a movie on a computer with insufficient system resources.



- ◆ See page 160 for settings that can be changed in this mode.
- ◆ Resolution/Frame Rate (p. 33)
- ◆ The following operations are available before movie recording:
 - AF lock: Pressing the **MF** button activates AF lock with the current conditions. **MF** appears on the LCD monitor. You can cancel AF lock by pressing the MF button again.
 - Manual Focus (p. 64)
 - AE lock, exposure shift: Press the **ISO** button to enable AE lock. The exposure shift bar appears on the LCD monitor, and exposure can be changed turning the multi control dial. You can cancel AE lock by pressing the **ISO** button again. When pressing the **MENU** button or changing the white balance, photo effects and shooting modes, AF lock is canceled.
- ◆ Sound is recorded in monaural.
- ◆ There is no shutter sound in Movie mode.

Continued on next page>>



- ◆ The recording time and capacity may vary according to camera usage and memory card performance. If free space in the camera's internal memory becomes too scarce, even if there is surplus recording time or capacity available, the "!" symbol will display at the bottom right of the LCD monitor in red and the camera will automatically cease filming shortly thereafter. If the "!" warning displays frequently, try the following procedures.
 - Reformat the memory card before filming (p. 23)
 - Set the resolution to  (320 x 240) or the frame rate to  (15 frames/sec.)
 - Use a super high-speed SD card (SDC-512MSH, etc.)
- ◆ QuickTime 3.0 or higher is required to play back movie files (AVI/ Motion JPEG) on a computer. (QuickTime for Windows is bundled on the supplied Digital Camera Solution Disk). On the Macintosh platform, this program is standard with Mac OS X or later.

Shooting Panoramic Images (Stitch Assist)

Use this mode to shoot a series of overlapping frames for merging (stitching) into a large panoramic image using a computer.

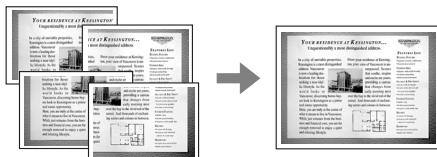
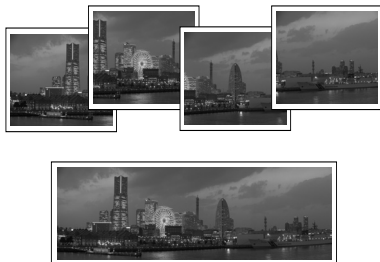

Please use the bundled PhotoStitch program to merge the images on a computer.

Framing a Subject

The PhotoStitch program detects the overlapping portions of adjoining images and merges them. When composing shots, try to include a distinctive item (landmark) in the overlapping portions.

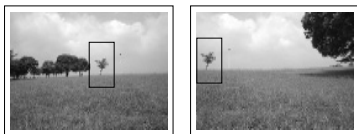

- ◆ Compose each frame so that it overlaps 30 - 50% of the adjoining image. Try to keep the vertical misalignment to less than 10% of the image height.
- ◆ Do not include moving items in the overlap.
- ◆ Do not try to stitch images that include both distant and close items. These items may appear warped or doubled up in the merged image.
- ◆ Make the brightness in each image consistent. The final image will appear unnatural if the contrast in brightness is too great.
- ◆ To shoot landscapes, swivel (pan) the camera around its own vertical axis.
- ◆ To shoot close-ups, slide the camera over the subject, keeping it parallel to the subject as you move it.

Shooting

Images can be shot in five sequences in Stitch Assist mode.

- Left to right horizontally
- Right to left horizontally
- Vertically, bottom to top
- Vertically, top to bottom
- Clockwise starting at the top left



- You cannot display the images on a TV when shooting in Stitch Assist mode.
- The settings for the first image are used to take subsequent images in the sequence.



- ◆ See page 160 for settings that can be changed in this mode.
- ◆ Digital zoom is not available.
- ◆ A custom white balance (p. 71) setting cannot be set in  (Stitch Assist mode). To use a custom white balance setting, first set it in another shooting mode.

1 Turn the mode dial to .

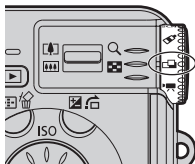

2 Select the shooting sequence using the multi control dial.

The shooting sequence is set.

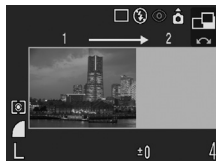

3 Shoot the first frame in the sequence.

The exposure and white balance settings are set and locked with the first image.

4 Compose the second image so that it overlaps a portion of the first and shoot.

- Minor discrepancies in the overlapping portions can be corrected when the images are stitched together.
- An image can be retaken. Press the **↑**, **↓**, **←** or **→** button to return to the previous frame.
- A maximum of 26 images can be recorded either horizontally or vertically.



5 Repeat the procedure for additional images.

6 Press the FUNC./SET button after the last shot.

Using the Mode Dial (Creative Zone)

Mode Dial

P Tv Av M

You can freely select camera settings such as the shutter speed and aperture value to suit your shooting purposes. After settings are made, shooting procedures are the same as for "AUTO Auto Mode" (Basic Guide: p. 8). See (p. 160) for settings that can be changed in this mode.

How to Use the Mode Dial

1 Check that the camera is in Shooting mode.

- The power/mode indicator lights orange.

2 Turn the mode dial, select the function you wish to use and shoot the image.



- The camera operates in the following ways according to the selected function:

P	The camera automatically sets the shutter speed and aperture value.
Tv	Select the shutter speed by turning the multi control dial.
Av	Select the aperture value by turning the multi control dial.
M	Select the shutter speed by turning the multi control dial and press the  button once, and select the aperture value by turning the multi control dial.



- The shutter speed and aperture value will show on the LCD monitor. The correct exposure has been set if the shutter speed and aperture value show in white on the LCD monitor when the shutter button is pressed halfway.
- The shutter speed, aperture value and the difference between the standard exposure will show in red on the LCD monitor when the correct exposure cannot be obtained.
- When the flash fires, the shutter speed and aperture value will show in white.
- In **P**, **Tv** or **Av**, the combinations of shutter speeds and aperture values can be changed within the same exposure setting (Program Shift p. 66).



- ◆ For information on the relation between the aperture value and shutter speed, see (p. 50, 51, 52).
- ◆ Please note that camera shake becomes a factor at low shutter speeds and with larger aperture values. If  (camera shake warning, blinking red) appears in the LCD monitor, try the following steps to resolve the problem.
 - Press the  button to enable firing
 - Use a tripod.
 - Raise the ISO speed

P Program AE

Use the program AE mode to have the camera automatically set the shutter speed and aperture value to match the brightness of the scene. If a correct exposure cannot be obtained, use the following methods to solve the problem.

- Use the flash.
- Adjusting the ISO Speed.
- Change the metering mode.

Differences between the P and **AUTO** Modes.

The following settings can be adjusted in **P** mode, but not in **AUTO** mode.

- | | | |
|---|-------------------------------|------------------|
| • Exposure Compensation | • White Balance | • ISO Speed |
| • Bracket | • Flash Exposure Compensation | • Intervalometer |
| • Flash (Flash on, Slow Synchro, 2nd-curtain) | | • Photo Effect |
| • Continuous shooting | • Metering Mode | • Manual Focus |
| • AF Lock | • Move AF Frame | • AE Lock |
| • FE Lock | • Program Shift | • Histogram |

Tv Setting the Shutter Speed

When you set the shutter speed in the shutter speed-priority AE mode, the camera automatically selects an aperture value to match the brightness. Faster shutter speeds allow you to catch an instantaneous image of a moving subject, while slower speeds create a flowing effect and allow you to shoot without a flash in dark areas.

- If the image would be underexposed (too dark) or overexposed (too bright) and the correct exposure cannot be obtained, with the shutter button pressed halfway, the aperture value display on the LCD monitor turns red. Turn the multi control dial to adjust the shutter speed and display the aperture in white characters on the display.

On the Shooting menu, set [Safety Shift] to [On]. The shutter speed is adjusted automatically to give pictures the correct exposure (p. 52).

Pressing the  button, places the camera in exposure correction mode (p. 69). Each time you press the button, you change modes. However, this is different under Manual focus (p. 64).

- The nature of CCD image sensors is such that noise in the recorded image increases at slow shutter speeds. This camera, however, applies special processing to images shot at shutter speeds slower than 1.3 seconds to

eliminate the noise, thereby producing high-quality images. Nevertheless, a certain amount of processing time may be required before the next image can be shot.

- The aperture value and shutter speed change according to the zoom state as follows.

	Aperture value	Shutter Speed (seconds)
Maximum Wide Angle	f/2.8 - f/3.5	up to 1/1250
	f/4.0 - f/8.0	up to 1/2000
Maximum Telephoto	f/5.3 - f/7.1	up to 1/1250
	f/8.0	up to 1/2000

- The fastest shutter speed for flash synchronization is 1/250 second. The camera automatically resets the shutter speed to 1/250 second if a faster speed is selected.

Shutter Speed Display

The numbers in the table below indicate the shutter speed in seconds. 1/160 indicates 1/160 second. Also, quote marks indicate the decimal place, so that 0"3 indicates 0.3 second and 2" indicates 2 seconds.

15" 13" 10" 8" 6" 5" 4" 3"2 2"5 2" 1"6 1"3 1" 0"8 0"6 0"5 0"4 0"3 1/4 1/5 1/6 1/8 1/10 1/13 1/15 1/20 1/25 1/30 1/40 1/50 1/60 1/80 1/100 1/125 1/160 1/200 1/250 1/320 1/400 1/500 1/640 1/800 1/1000 1/1250 1/1600 1/2000
--

Av Setting the Aperture

When you set the aperture in the aperture-priority AE mode, the camera automatically selects a shutter speed to match the brightness. Selecting a lower aperture value (opening the aperture) allows you to blur the background and create a beautiful portrait.

A higher aperture value (closing it) brings the entire range from foreground to background into focus. The larger the aperture value, the greater the range of the image brought into clear focus.

- If the image would be underexposed (too dark) or overexposed (too bright) and the correct exposure cannot be obtained, with the shutter button pressed halfway, the shutter speed display on the LCD monitor turns red. Turn the multi control dial to adjust the aperture and display the shutter speed in white characters on the display.

On the Shooting menu, set [Safety Shift] to [On]. The aperture is adjusted

automatically to give pictures the correct exposure (p. 52).

Pressing the  button, places the camera in exposure correction mode (p. 69). Each time you press the button, you change modes. However, this is different under Manual focus (p. 64).

- Some aperture values cannot be selected depending on the zoom position.
- In this mode, the maximum shutter speed with synchronized flash is 1/250 second. The aperture value setting may therefore be changed automatically to match the synchronized flash speed even if its value was set previously.

Aperture Setting Display

The larger the aperture value the smaller the lens opening, allowing less light to enter the camera.

F2.8 F3.2 F3.5 F4.0 F4.5 F5.0 F5.3 F5.6 F6.3 F7.1 F8.0
--

Safety Shift

With **Tv** and **Av** modes, if [Safety Shift] is turned [On] in the Rec. menu, the shutter speed or aperture value is automatically adjusted for the correct exposure when it cannot be otherwise obtained.

- Safety Shift is disabled when the flash is enabled.



M Manually Setting the Shutter Speed and Aperture

You can manually set the shutter speed and aperture to achieve a particular effect. Use this for shooting in special conditions, such as for time exposures.

You can modify the shutter speed by turning the multi control dial.

Pressing the  button allows you to modify the aperture value.

Each time you press the  button, you change modes. However, this is different under Manual focus (p. 64).

- The brightness of the LCD monitor matches the selected shutter speed and aperture value. When you select a fast shutter speed or shoot a subject in a dark place and set the flash to  (Flash On with red-eye reduction) or  (Flash On) the image will always be bright.
- Displaying the histogram, you can shoot while confirming and adjusting image brightness. (p. 20, 28)
- When you press the shutter button halfway, the difference between the standard exposure* and the selected exposure appears on the LCD monitor.

If the difference is more than 2 stops, "-2" or "+2" appears on the LCD monitor in red.

- * The standard exposure is calculated by measuring the brightness according to the selected metering method.







Shooting in a My Colors Mode



Mode Dial





A My Colors mode easily changes the colors in an image when it is shot, allowing you to alter the balance between red, green and blue, transform pale or tanned skin or change a color specified in the LCD monitor into a different color. Since they work with both stills and movies, these modes let you enjoy producing various image or movie effects.

However, depending on the shooting conditions, the images may appear rough or you may not get the expected color. Before you try to photograph important subjects, we highly recommend that you shoot trial images and check the results. Moreover, the camera will record both the My Colors image and the original unaltered image if you set [Save Original] (p. 54) to [On].

	Positive Film	Use this option to make red, green or blue colors more intense like the Vivid Red, Vivid Green or Vivid Blue effects. It can produce intense natural-appearing colors like those obtained with positive film.
	Lighter Skin Tone*	Use this option to make skin tones lighter.
	Darker Skin Tone*	Use this option to make skin tones darker.
	Vivid Blue	Use this option to emphasize blue tints. It makes blue subjects, such as the sky or ocean, more vivid.
	Vivid Green	Use this option to emphasize green tints. It makes green subjects, such as mountains, new growth, flowers and lawns, more vivid.
	Vivid Red	Use this option to emphasize red tints. It makes red subjects, such as flowers or cars, more vivid.













	Color Accent	Use this option to have only the color specified in the LCD monitor remain and to transform all others to black and white.
	Color Swap	Use this option to transform a color specified in the LCD monitor into another. The specified color can only be swapped into one other color, multiple colors cannot be chosen.
	Custom Color	Use this option to freely adjust the color balance between red, green, blue and skin tones*. It can be used to make subtle adjustments, such as making blue colors more vivid or face colors brighter.

* The skin colors of non-human subjects may also be altered.
You may not obtain the expected results depending on the skin color.

 To shoot a movie using My Colors, first select  by turning the multi control dial (p. 41), and perform the procedure below.

1 Press the FUNC./SET button and select (Positive Film)* with the or button, then select the desired My Colors mode with the or button.

* The current setting is displayed.

- With , , , ,  and , press the **FUNC./SET** button to return to the shooting screen and start shooting.
- With , , , refer to each shooting procedure.
 -  See *Shooting in the Color Accent Mode* (p. 55)
 -  See *Shooting in the Color Swap Mode* (p. 56)
 -  See *Shooting in the Custom Color Mode* (p. 58)
- Settings can be made by turning the multi control dial.



See page 160 for settings that can be changed in this mode.

Changing the Save Method for the Original Image

When you are shooting still images in a My Colors mode, you can specify whether or not both the altered image and the original image are recorded.

1 In the [(Rec.)] menu, select [Save Original].

See *Selecting Menus and Settings* (Basic Guide: p. 16).

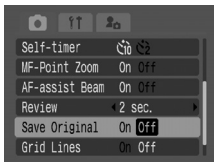

2 Use the ← or → button to select [On] or [Off] and press the MENU button.

- The display will return to the shooting screen.
- Select [On] to record the original image too or [Off] to not record it.
- When [On], images are numbered sequentially. The original image has the lower number, and the altered image shot with My Colors has the higher number.
- Settings can be made by turning the multi control dial.

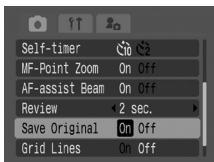

[Save Original] is Set to [On]

- ◆ Only the altered image is shown in the LCD monitor during shooting.
- ◆ The image that appears in the LCD monitor immediately after recording is the altered image (p. 53). If you erase the image at this point, the original image is erased along with the altered image. Exercise adequate caution before deleting a file.
- ◆ Two images are recorded with each shot, so the number of available shots displayed on the LCD monitor is halved.

Shooting in the Color Accent Mode

Colors other than the color specified in the LCD monitor are shot in black and white.

1 Select (Color Accent) from the FUNC. menu and press the MENU button.

- See *Shooting in a My Colors Mode* (p. 53)
- All colors but the previously specified one display in black and white.
- The camera switches to color input mode and the display alternates between the original image and the color accent image (the default setting is green).

2 Aim the camera so that the color you wish to retain appears at the center of the LCD monitor and press the **←** button.

- Only one color can be specified.
- You can use the **↑** or **↓** button to specify the range of colors that are retained.
 - 5: Only takes the color that you want to retain.
 - +5: Also takes colors close to the one that you want to retain.
- You can shoot right after selecting an option. The menu displays again after the shot so you can easily adjust the setting.

3 Press the **FUNC./SET** button.

- This completes the setting.
- If you press the MENU button at this point, you will return to the screen where you can select a My Colors mode.



- ◆ You may not obtain the expected results after color input mode if you use the flash, or change the white balance or metering settings.
- ◆ The chosen Color Accent is retained even if the camera's power is turned off.
- ◆ Exposure compensation is disabled while **EA** (Color Accent) is enabled.

Shooting in the Color Swap Mode

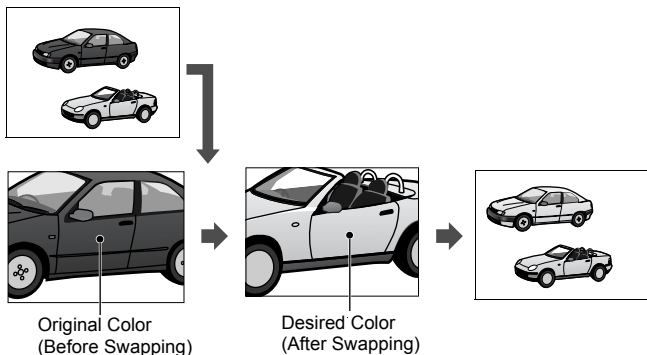

This mode allows you to transform a color specified in the LCD monitor into another.



1 Select (Switch Color) from the FUNC. menu and press the MENU button.

- See *Shooting in a My Colors Mode* (p. 53)
- The camera will switch to color input mode and the display will alternate between the original image and the color swap image (using the previously set color) (The default color to change is green, which changes to white after setting).

2 Aim the camera so that the original color appears at the center of the LCD monitor, and press the button.

- Only one color can be specified.
- You can use the  or  button to specify the range of colors that are swapped.
 - 5: Only takes the color that you want to swap.
 - +5: Also takes colors close to the one that you swap.

3 Aim the camera so that the desired color appears at the center of the LCD monitor and press the button.

- Only one color can be specified.
- You can shoot right after selecting an option. The menu displays again after the shot so you can easily adjust the setting.

4 Press the FUNC./SET button.

- This completes the setting.
- If you press the MENU button at this point, you will return to the screen where you can select a My Colors mode.



- ◆ You may not obtain the expected results after color input mode if you use the flash, or change the white balance or metering settings.
- ◆ The colors specified in the color swap mode are retained even if the camera's power is turned off.
- ◆ Exposure compensation is disabled while  (Color Swap) is enabled.

Shooting in the Custom Color Mode

This mode allows you to adjust the color balance for red, green, blue and skin tones.

1 Select (Custom Color) from the FUNC. menu and press the MENU button.

Shooting in a My Colors Mode (p. 53)

2 Use the or button to select [Red], [Green], [Blue] or [Skin Tone] and adjust the color balance with the or button.

- The custom color image will display.
- Settings can be made by turning the multi control dial.



Select a color.

Adjust the color balance.

3 Press the FUNC./SET button.

- This completes the setting.
 - If you press the MENU button at this point, you will return to the screen where you can select a My Colors mode.
-

Registering Settings to the Shortcut Button

One frequently used function can be registered to the  (Shortcut) button.

You can register the following functions. However, not all functions can be registered depending on the shooting mode.

- Resolution (Default setting) (p. 33)
- White Balance*¹ (p. 70)
- Photo Effect*² (p. 72)
- AE Lock (p. 65)
- Create New Folder (p. 86)
- Frame Rate (p. 33)
- My Colors (p. 53)
- Metering System (p. 68)
- AF Lock (p. 63)

*1 A custom white balance can be used once a custom white balance reading has been taken.

*2 A custom photo effect can be used once a custom effect has been set.

Registering a Function

1 Select [Set Shortcut button] from the  (Rec.) menu and press the **FUNC./SET** button.

- See *Selecting Menus and Settings (Basic Guide)*: p. 16).

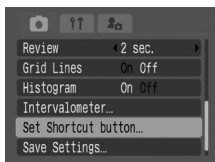

2 Use the **←** or **→** button to select the function you wish to register and press the **FUNC./SET** button.



- If an "x" mark appears on the lower right of the icon, you can still register this function but the current shooting mode will be retained and pressing the shortcut button will not activate the function.
- Settings can be made by turning the multi control dial.



Using the Shortcut Button

1 Press the button.

The registered function is activated and its icon appears on the LCD monitor or viewfinder.

- Each press of the  button cycles between setting values of the registered function.
- Functions that are not available in the current shooting mode will not appear even if they are registered. Select a compatible shooting mode and press the  button again.



Selecting an AF Frame

The AF frame indicates the area of the composition on which the camera focuses. You can set the AF frame in the following way.

- For selecting AiAF (auto selection) or 1-point, see below.
- See *Setting an AF Frame Manually*. (p. 61)

Mode Dial

AUTO SCN*  **P Tv Av M**

*  (Kids&Pets),  (Fireworks) modes cannot be set.

You can set the AF frame to Auto Selection (AiAF) or to 1-point. When Auto Selection (AiAF) is selected, the camera automatically selects an AF frame from 9 points to focus according to the shooting conditions. With the digital zoom, the 1-point AF-frame is always selected.

1 Press the button.

The AF frame appears in green on the LCD monitor.

- Turn the multi control dial to select the auto selection or 1-point AF frame.



- Press the  button.

You can shoot the image using the selected AF frame by pressing the shutter button instead of pressing the  button.

Setting an AF Frame Manually





Mode Dial



P Tv Av M

You can move the AF frame manually to the desired position. This is convenient for focusing accurately on your chosen subject to obtain the composition you desire.

- Press the  button, settings can be made by turning the multi control dial and selecting 1-point.

The AF frame appears in green on the LCD monitor.

- Move the AF frame to the position you wish to set using the , ,  or  button, then press the  button.

- You can immediately shoot the image using the selected AF frame by pressing the shutter button instead of pressing the  button.
- The AF frame will move back to its original position (center), if you hold down the  button.



- ◆ Turn the LCD monitor on to set the AF frame to the position you desire before shooting.
- ◆ The AF frame is locked to 1-point when using the digital zoom or when an image is shot using the viewfinder with the LCD monitor off.
- ◆ For an explanation of the AF frame colors (p. 17).
- ◆ When [Spot] is selected as the metering mode, you can use the selected AF frame as the spot AE point (p. 68).
- ◆ See *Photo Tips and Information* (p. 144).

Shooting Problem Subjects for the Autofocus

The autofocus may not work well on the following types of subjects.

- Subjects with extremely low contrast to the surroundings
- Subjects mixing close and far objects
- Subjects with extremely bright objects at the center of the composition
- Subjects that are moving quickly
- Subjects through glass: Try to shoot as close to the glass as possible to reduce the chances of light reflecting back off the glass.

To shoot these subjects, first aim the camera at an object at a similar distance, lock the focus and recompose the image with the desired subject, or use manual focus or AF lock.

Shooting with the Focus Lock



Mode Dial

AUTO SCN    **P Tv Av M**

*Excluding  (Fireworks) mode.

- 1 Aim the camera so that an object at the same focal distance as the main subject is centered in the AF frame displayed on the LCD monitor.**

2 Press the shutter button halfway to lock the focus.

- A beep sounds and the AF frame turns green (the AF frame is not displayed with  (Stitch Assist) and  (Movie)).
- The AE setting will also lock when you do this. The exposure may occasionally be incorrect if the difference in intensity between the two items is too great. In this case, shoot with AF Lock (p. 63) or AE Lock (p. 65).

3 Keep the shutter button pressed while you recompose the image and press the shutter button all the way to shoot the image.

Shooting with the AF Lock

Mode Dial

SCN*    P Tv Av M

*  (Fireworks) mode cannot be set.





1 Aim the camera so that an object at the same focal distance as the main subject is centered in the AF frame.

2 Press the shutter button halfway and while keeping it pressed, press the MF button.

- After a beep sounds and the AF frame turns green, press the **MF** button.
- **MF** appears on the LCD monitor.
- The focus will stay locked even if you release the shutter button and **MF** button.
- Pressing the **MF** button a second time cancels the manual AF lock. Operating anything other than the multi control dial or the  button will cancel the manual AF lock.

3 Recompose the image and press the shutter button all the way to shoot the image.



- ◆ The AF lock is convenient because you can let go of the shutter button to compose the image. In addition, since the focus stays locked to the same position even after the shot is taken, you can immediately shoot the next image with the same focus position.
- ◆ Because  (Stitch Assist) and  (Movie) do not display the AF frame, aim the camera to focus on the subject.
- ◆ In  mode, AF lock can be set or canceled even during movie recording (p. 41).
- ◆ If  is registered as the shortcut key, AF Lock can be performed without pressing the **MF** button (except for ).

Shooting in Manual Focus Mode



Mode Dial



SCN*   **P** Tv Av M

*  (Fireworks) mode cannot be set.

The focus can be manually set.

1 Press the MF button.

- The focus will lock and the  icon and the MF indicator will appear on the LCD monitor.
- When the [ (Rec.)] menu's [MF-Point Zoom] is set to [On], if a particular AF frame has been manually selected, the portion of the image in that frame will appear magnified*.



- * However, when using  (Stitch Assist),  (Movie), digital zoom or while displaying the image on a TV, the display magnification is not available.
- * Can also be set so that the image displayed is not magnified (p. 27).



MF Indicator

2 Turn the multi control dial to adjust the focus of the camera.

- Adjust the focus until the image appears focused. After setting the focus, pressing the  button causes the camera to automatically refocus more precisely at a point near the current focusing point.
- The MF indicator shows approximate figures. Use them as a shooting guideline only.
- Pressing the **MF** button a second time cancels the manual focus mode.

- Press the  button to switch to Exposure mode. Each time you press the  button, the mode changes (p. 69). Depending on the shooting mode, the following changes will occur:

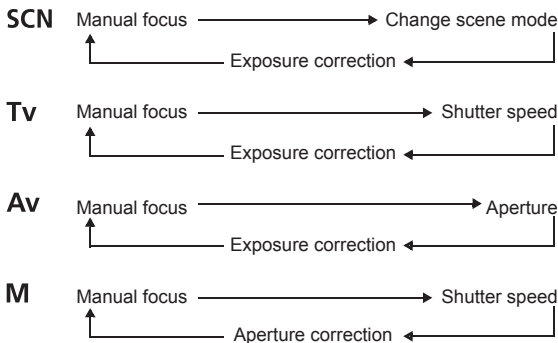

3 Press the shutter button all the way to shoot the image.



You cannot change the AF frame setting while focusing manually. Cancel the manual focus mode, then change the AF frame setting.



You can change distance units displayed on the MF indicator (p. 30).

Locking the Exposure Setting (AE Lock)

Mode Dial

  **P Tv Av**

You can set the exposure and focus separately. This is effective when the contrast is too strong between the subject and background or when a subject is backlit.



You must set the flash to . The AE lock cannot be set if the flash fires. For flash shots, use FE lock (p. 67).

1 Focus the 1-point AF frame or the spot metering frame on the subject on which you wish to lock the exposure setting and press the shutter button halfway.

- *Position the AF Frame* (p. 60)
- *Switching between Metering Modes* (p. 68)
- In  mode, AE lock can be set or canceled (p. 41).

2 While pressing the shutter button halfway, press the ISO button.

- The exposure value is captured (AE Lock) and  appears on the LCD monitor.



AE lock

3 Recompose the image and shoot.

The camera focuses on the subject in the AF frame.



After performing AE lock, using anything except the shutter button or the multi control dial, or using Power Saving cancels the AE lock.



Automatically selected combinations of shutter speeds and aperture values can be freely changed without altering the exposure (Program Shift), with the following procedures.



1. Turn the mode dial to **P**, **Tv** or **Av**.
2. Focus on the subject on which you wish to lock exposure.
3. While pressing the shutter button halfway, press the ISO button to set the exposure (an  appears on the LCD monitor), after releasing the shutter button, turn the multi control dial, and select the desired shutter speed or aperture.
4. Recompose the image and shoot. The setting will cancel after the shot is taken.

Locking the Flash Exposure Setting (FE Lock)

Mode Dial

 P Tv Av

You can obtain the correct exposure regardless of the location of your subject in the composition.

1 Press the  button and display  on the LCD monitor.

2 Focus the AF frame or the spot metering frame on the subject on which you wish to lock the flash exposure setting and press the shutter button halfway.

3 Pressing the shutter button halfway, press the ISO button halfway.

- The flash pre-fires to acquire the exposure value required for the subject, and  appears on the LCD monitor.
- Each time you press the ISO button, the flash exposure locks at the required intensity for that composition.

4 Recompose the image and shoot.



After performing FE lock, using anything except the shutter button or the multi control dial cancels the FE lock.





- ◆ FE Lock is not available while  is displayed on the LCD monitor.
- ◆ The FE lock function is not available when [Flash Adjust] is set to [Manual].

Switching between Metering Modes

Mode Dial

 P Tv Av M

Metering measures the brightness of a subject. By selecting the optimal mode, you can shoot a subject with the optimal exposure. Evaluative metering is the default metering mode.

	Evaluative	The camera divides images into several zones for metering. The camera evaluates complex lighting conditions, such as the position of the subject, the brightness, the background, the direct light, and the backlighting, and adjusts the settings to the correct exposure for the main subject.
	Center-Weighted Average	Averages the light metered from the entire frame, but gives greater weight to the subject matter at the center.
	Spot AE Point	Meters the area within the spot AE point frame.
	Center	Locks the spot metering frame to the center of the LCD monitor.
	AF Point	Moves the spot AE point to the AF frame.

1 Select (Metering Method) from the FUNC. menu, and a metering method with the \leftarrow or \rightarrow button.

- [Evaluative] and [Center-Weighted Averaging] shoot the subject as it appears.
To set [Spot AE Point], go to Step 2.
- Settings can be made by turning the multi control dial.

2 In the (Rec.) menu, select [Spot AE Point].

See *Selecting Menus and Settings (Basic Guide)*: p. 16).

Set the AF Point to 1-point. (p. 60)

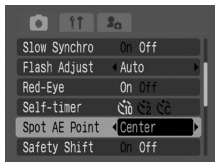

3 Use the \leftarrow or \rightarrow button to select [Center] or [AF Point], then press the MENU button.

- When [Spot AE Point] is set to [Center], the spot AE point frame (\square) appears at the center of the LCD monitor. The AF frame can be repositioned (p. 60)
- With [AF Point], the AE point appears within an AF frame.
- Settings can be made by turning the multi control dial.



[\square]: Spot AE Point
 [\square]: AF Frame

Adjusting the Exposure

Mode Dial

SCN   P Tv Av

Adjust the exposure compensation setting to avoid making the subject too dark when it is backlit or shot against a bright background or to avoid making lights appear too bright in night shots.

1 Press the button*, and then turn the multi control dial to adjust the exposure.

- The settings can be adjusted in 1/3-stops in the range of -2 stops to +2 stops.
- You can shoot the image right after selecting settings by pressing the shutter button. The menu displays again after the shot, allowing you to change the settings easily.
- To cancel the exposure compensation, return the setting to \odot with the multi control dial.



◆ Exposure shift settings can be made/canceled in  (Movie) mode (p. 41).

◆ See *Photo Tips and Information* (p. 145).











Adjusting the Tone (White Balance)

Mode Dial

 P Tv Av M

When the white balance mode is set to match the light source, the camera reproduces colors more accurately.

Combinations of setting contents and light source are as follows.

	Auto	Settings are automatically set by the camera
	Day Light	For recording outdoors on a bright day
	Cloudy	For recording under overcast, shady or twilight skies
	Tungsten	For recording under tungsten and bulb-type 3-wavelength fluorescent lighting
	Fluorescent	For recording under warm-white, cool-white or warm-white (3-wavelength) fluorescent lighting
	Fluorescent H	For recording under daylight fluorescent, or daylight fluorescent-type 3-wavelength fluorescent lighting
	Flash	When using the flash (cannot be set in  (Movie) mode)
	Underwater	Appropriate for shooting images with the Waterproof Case WP-DC1 (sold separately). This mode yields image data in the optimal white balance to record images with natural hues by reducing the bluish tone.
	Custom	After memorizing a white reference data value based on a white object such as a sheet of paper or cloth, you can start shooting.

1 Select * (Auto) from the FUNC. menu and select the desired white balance with the or button.

* The current setting is displayed.

- Select  (Manual) (p. 71)
- You can shoot the image right after selecting settings by pressing the shutter button. The menu displays again after the shot, allowing you to change the settings easily.
- Settings can be made by turning the multi control dial.





The white balance cannot be adjusted when the photo effect is set to (Sepia) or (B/W) (p. 72).

Setting a Custom White Balance

In the following cases, the white balance may not be correctly adjusted in (Auto). After taking a custom white balance reading with (Custom), you can start shooting.

- Shooting close-ups (Macro)
- Shooting subjects of monotone color (such as sky, sea or forest)
- Shooting with a peculiar source of light (such as a mercury-vapor lamp)

1 Select * (Auto) from the FUNC. menu and select (Custom) with the **←** or **→** button.

* The current setting is displayed.

Settings can be made by turning the multi control dial.



2 Aim the camera at a piece of white paper, cloth or gray card and press the **MENU** button.

The white balance data is recorded.

- Aim the camera so that the white reference paper or cloth completely fills the center of the frame, and press the **MENU** button.
- You can shoot the image right after selecting settings by pressing the shutter button.

The menu displays again after the shot, allowing you to change the settings easily.



Evaluate White Bal. frame



- ◆ You are recommended to set the white balance when shooting in the following conditions.
 - **The shooting mode is set to P and the exposure compensation and flash exposure adjustment are set to ± 0.**

The correct white balance may not be obtained when the exposure is incorrect (image is completely black or white).

Continued on next page>>



- **The zoom is positioned to the maximum telephoto setting.**

Set the digital zoom to [Off].

- **Set the flash according to shooting conditions, and select (Flash On) or (Flash Off)**

Use the same flash setting as the one that will be used for shooting when you set the white balance. If the white balance setting conditions and shooting conditions are not the same, the correct white balance may not be obtained. (When the flash is set to (Auto with redeye reduction) or (Auto), the flash may fire while the white balance data is recorded to the custom white balance. If this happens, make sure the flash also fires when you shoot the image.)

- **The ISO speed is set to the same setting to shoot the image.**
- ◆ White balance data cannot be set with (Stitch Assist), but the white data acquired in another mode can be used.
- The custom white balance will not be canceled even if you reset camera settings to default (p. 32).

Changing the Photo Effect

Mode Dial



By setting a photo effect before you shoot, you can change the look and feel of the pictures you take.

	Effect Off	Records normally with this setting.
	Vivid	Emphasizes the contrast and color saturation to record bold colors.
	Neutral	Tones down the contrast and color saturation to record neutral hues.
	Low Sharpening	Records subjects with softened outlines.
	Sepia	Records in sepia tones.
	B/W	Records in black and white.
	Custom Effect ^{*2}	You can freely set the contrast, sharpness and color saturation.

*1  My Colors (Movie) mode cannot be set.

*2 **P**, **Tv**, **Av** and **M** modes only

1 Select * (Effect Off) from the **FUNC.** menu and select the desired photo effect with the **←** or **→** button.

* The current setting is displayed.

- You can shoot the image right after selecting settings by pressing the shutter button. The menu displays again after the shot, allowing you to change the settings easily.
- Settings can be made by turning the multi control dial.



When is selected

- A screen allowing you to set the contrast, sharpness and color saturation appears when you press the **MENU** button. Select the item you wish to set using the **↑** or **↓** button, set it using the **←** or **→** button and press the **MENU** button. Settings can be made by turning the multi control dial.
- You can shoot the image right after selecting settings by pressing the shutter button. The menu displays again after the shot, allowing you to change the settings easily.

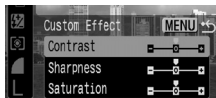

Contrast

- This function allows you to adjust the degree of brightness.
- Select from - (Weak), 0 (Neutral) and + (Strong).



Sharpness

- This function allows you to adjust how sharply outlines are defined.
- Select from - (Weak), 0 (Neutral) and + (Strong).

Saturation

- This function allows you to adjust the color depth.
- Select from - (Weak), 0 (Neutral) and + (Strong).



The white balance cannot be set when  (Sepia) or  (B/W) mode is selected.

ISO Changing the ISO Speed

Mode Dial

P Tv Av M

By raising the ISO speed, you can shoot bright images even in poor lighting conditions. This function is convenient when you want to prevent camera shake, shoot without the flash or shoot with a faster shutter speed in dark conditions.

You can choose from the following speeds: Auto, 50, 100, 200 and 400.

1 Press the ISO button.

- Pressing the ISO button successively alternates between AUTO, 50, 100, 200, 400, and back to AUTO.
- You can shoot the image right after selecting settings by pressing the shutter button. The menu displays again after the shot, allowing you to change the settings easily.



- Higher ISO speeds increase image noise. To take clean images, use as low an ISO speed as possible.
- The [AUTO] setting selects the optimal speed. It will automatically raise the speed when the light from the flash is insufficient to illuminate the subject matter.



See *Photo Tips and Information* (p. 145).

Auto Exposure Bracketing (AEB Mode)

Mode Dial

P Tv Av

The camera automatically takes three shots: one with standard exposure and one each with positive and negative compensation.

You can adjust AEB settings in 1/3 stops within ± 2 EV of the standard exposure setting. AEB settings can be combined with exposure compensation settings (p. 69) to extend the adjustment range. The images are recorded in the following order: Standard exposure, underexposure and overexposure.

 The three shots are taken at the same interval as continuous shooting. See *Continuous Shooting* (p. 40).

1 From the FUNC. menu, select * (BKT-OFF).

* The current setting is displayed.



2 Use the \leftarrow or \rightarrow button to select  (AEB), press the MENU button and adjust the compensation range with the \leftarrow or \rightarrow button.

- Settings can be made by turning the multi control dial.
- Pressing the \rightarrow button increases the compensation, and pressing the \leftarrow button decreases it.
- You can shoot the image right after selecting settings by pressing the shutter button. The menu displays again after the shot, allowing you to change the settings easily.
- Select  (BKT-Off) to cancel the AEB mode.



-  The AEB mode cannot be used for flash photography. If the flash fires, only one standard exposure image gets recorded.
- Three images are shot continuously regardless of the continuous shooting setting (p. 40).

Focus Bracketing (Focus-BKT Mode)

Mode Dial

P Tv Av M

The camera automatically takes three shots: one at the manual focus position, and one each with focus positions preset nearer and farther. The nearer and farther focus positions can be set in three steps: large, medium and small. Images are shot with the focus position changing in the following order; current position, farther and nearer.



The three shots are taken at the same interval as continuous shooting. See *Continuous Shooting* (p. 40).

- 1** Select * (BKT-Off) from the FUNC. menu and use the **←** or **→** to select (Focus-BKT), then press the MENU button.

- * The current setting is displayed.
- Settings can be made by turning the multi control dial.



- 2** Set the amount of focus position offset with the **←** or **→** button.

- Press the **→** button to broaden or the **←** button to narrow the focusing distance from the center.
- Settings can be made by turning the multi control dial.
- You can shoot the image right after selecting settings by pressing the shutter button. The menu displays again after the shot, allowing you to change the settings easily.



- 3** Press the FUNC./SET button and shoot the image with the manual focus (p. 64).



- The Focus-BKT mode is not available when shooting with the flash on. Only one image at the manual focus position will be taken.
- Three images are shot continuously regardless of the continuous shooting setting (p. 40).

⚡ Switching between Built-in Flash Adjustment Settings

Mode Dial

Tv Av

The built-in flash fires with automatic flash adjustments (except in the **M** mode), but it is possible to set it so that it fires without any adjustments.

1 Select [Flash Adjust] from the [Rec.] menu.

See *Selecting Menus and Settings (Basic Guide: p. 16)*.

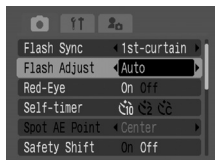

2 Use the ← or → button to select [Auto] or [Manual] and press the MENU button.

Settings can be made by turning the multi control dial.

Setting the Flash Adjustment/Flash Output

Mode Dial

P Tv^{*1} Av^{*1} M^{*2}

*1 When [Flash Adjust] is set to [Manual], flash output settings can be made.

*2 Only [Flash output] can be set.

Flash Exposure Compensation	<ul style="list-style-type: none">• When [Flash Adjust] is set to [Auto], settings can be adjusted in 1/3-stop increments in the range of -2 EV to +2 EV.• You can enjoy flash photography with exposure adjustments with the combined use of the camera's exposure compensation function.
Flash Output	<ul style="list-style-type: none">• In M mode or when [Flash Adjust] is set to [Manual], the flash output can be controlled in three steps, up to FULL, when shooting.

1 Select (Flash or Flash Output) from the FUNC. menu.

The available settings are displayed.



e.g. [Flash Adjust] set to [Auto]

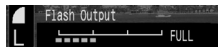

e.g. [Flash Adjust] set to [Manual]

2 Use the or button to adjust the compensation or flash intensity.

- Settings can be made by turning the multi control dial.
- You can shoot the image right after selecting settings by pressing the shutter button. The menu displays again after the shot, allowing you to change the settings easily.



- ◆ The flash fires with automatic adjustments when [Flash Adjust] is set to [Auto] in the Rec. menu. Automatic adjustment sets the flash intensity. When shooting in **M** mode, or with [Flash Adjust] set to [Manual], the flash fires with the manually set adjustments. For manual flash, you set flash intensity in advance.
- ◆ When [Flash Adjust] is set to [Auto], the flash fires twice. A pre-flash will fire and will be followed by the main flash. The pre-flash is used by the camera to obtain the subject's exposure data so that the main flash can be set to the optimal intensity for the shot. However, the pre-flash does not fire when shooting with FE Lock enabled (p. 67).

Switching the Timing at which the Flash Fires

Mode Dial

 P Tv Av M

1st-curtain	The flash fires right after the shutter opens, regardless of the shutter speed. Usually, the 1st-curtain is used when shooting.
2nd-curtain	The flash fires right before the shutter closes. Compared with the 1st-curtain, the flash fires later and this allows you to shoot images in which, for example, a car's lights seem to trail off behind.



Image shot with the 1st-curtain setting



Image shot with the 2nd-curtain setting

1 Select [Flash Sync] from the [] menu.

See *Selecting Menus and Settings (Basic Guide: p. 16)*.

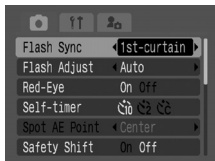

2 Use the or button to select [1st-curtain] or [2nd-curtain].

Settings can be made by turning the multi control dial.

Shooting Images at Set Intervals (Intervalometer)

Mode Dial

P Tv Av M

You can shoot images at a set interval. This function can be used for fixed-point observation of plants and blooming flowers. The shooting interval time can be set from 1 to 60 minutes and 2 to 100 images can be shot.



Since the camera may shoot continuously for an extended period of time, the use of the AC Adapter Kit ACK-DC20 (sold separately) is recommended (p. 128).

1 Select [Intervalometer] from the [] (Rec.) menu and press the FUNC./SET button.

See *Selecting Menus and Settings (Basic Guide)*: p. 16).

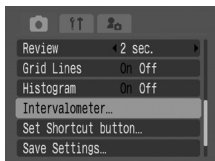

2 Use the ← or → button to select an interval time.

- If you press the ← or → button continuously, the interval time changes in units of 5 minutes at a time.
- Settings can be made by turning the multi control dial.

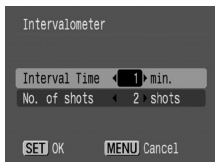

3 Press the ↓ button and select the number of shots using the ← or → button.

- If you press the ← or → button continuously, the number of shots changes in units of 5 shots at a time.
- Settings can be made by turning the multi control dial.
- The maximum number of shots* is determined by the available space on the memory card.
 - * The maximum number of shots may be reduced according to the images already shot.

4 Press the FUNC./SET button.

The camera exits the menu screen and Int. appears at the lower right of the LCD monitor.

5 Press the shutter button.

- The first image is shot and the interval shooting session starts.
- Once the set number of shots is taken the camera automatically powers down regardless of the power saving function settings.
- If the below operations are accessed while the interval shooting is in process, the interval shooting session will be canceled.
 - Turning the mode dial while the camera is waiting to shoot the next image
 - Pressing the shutter button halfway while the camera is waiting to shoot the next image
 - Opening the memory card slot / battery cover
 - Switching to Playback mode
 - Turning off the power



- Once the interval shooting session is started, all operation buttons become inactive.
- The lens stays extended until the next image is shot.
- Images are not displayed on the LCD monitor right after being shot.
- Interval shooting is not available when the date and time are not set.
- AEB mode and the Focus-BKT mode settings cannot be set.
- The Self-timer can only be used for the first shot in the series.

C Saving Custom Settings

Mode Dial

P Tv Av M C

You can save frequently used shooting modes and various shooting settings to the **C** (Custom) mode. When necessary, you can then shoot images with previously saved settings by simply turning the mode dial to **C**. Settings that are usually forgotten when the shooting mode is changed or when the power is turned off (such as Continuous Shooting and Self-timer mode) are also remembered.

1 Turn the mode dial to **P**, **Tv**, **Av**, **M** or **C**.

When you wish to re-save partially modified settings (except shooting mode) that were previously saved in the **C** mode, select **C**.

2 Set the setting contents you wish to save.

Settings that can be saved to the **C** mode

- Shooting mode (**P**, **Tv**, **Av**, **M**)
- Items that can be set in **P**, **Tv**, **Av** and **M** modes (p. 160)
- Shooting menu settings
- Zoom Setting
- Manual focus location

3 Select [Save Settings] from the [(Rec.)] menu and press the FUNC./SET button.

- See *Selecting Menus and Settings (Basic Guide)*: p. 16).

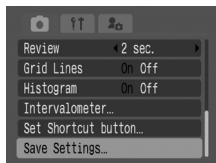

4 Select [OK] and press the FUNC./SET button.



- ◆ The setting contents do not influence other shooting modes.
- ◆ Saved settings can be reset (p. 32).

Setting the Auto Rotate Function

Mode Dial

AUTO SCN P Tv Av M

Your camera is equipped with an Intelligent Orientation sensor that detects the orientation of an image shot with the camera held vertically and automatically rotates it to the correct viewing orientation in the display. You can set this function on/off.

1 Select Shooting mode or Playback mode, then select [Auto Rotate] in the [MENU] (Set up) menu.

- See *Selecting Menus and Settings (Basic Guide: p. 16)*.
- If you set it to [On] in Shooting mode, the direction of the image that you shoot is recorded.
- If you set it to [On] in Playback mode (but only if you set [Auto Rotate] to [On] in Shooting mode) the images appear right side up on the LCD monitor, regardless of the direction of the camera.

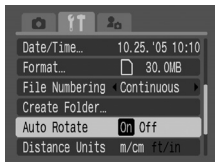

2 Use the ← or → button to select [On] and press the MENU button.

- Settings can be made by turning the multi control dial.
- The display will return to the shooting or playback screen.
- When this function is [On] and the camera is in shooting mode and set to Information View, an icon showing camera orientation (: normal, : right side down, and : left side down) appears at the upper right corner of the LCD monitor.



- This function may not operate correctly when the camera is pointed straight up or down. Check that the correct camera orientation icon (e.g.) is displayed and if it is not, then set the Auto Rotate function to [Off].
- Even if the Auto Rotate function is set to [On], the orientation of images downloaded to a computer will depend upon the software used to download the images.



- ◆ When the camera is held on end to shoot, the Intelligent Orientation sensor judges the upper end to be "up" and the lower end to be "down". It then regulates the optimal white balance and exposure for vertical photography. This function operates regardless of the On/Off status of the Auto Rotate function.
- ◆ If you set it to [On] during shooting and to [On] during playback, the images you shoot appear right side up regardless of the direction of the camera.

Resetting the File Number

The images you shoot are automatically assigned file numbers. You can select how the file number is assigned.

Continuous	A number one higher than the last one recorded is assigned to the next image. This is convenient for managing all your images together on a computer because you avoid file name duplication when changing folders or memory cards.*
Auto Reset	The image and folder number are reset to the starting value (100-0001).* This is convenient for managing images on a folder-by-folder basis.

* When a blank memory card is used. If a memory card with recorded data is used, the 7-digit number for the last recorded folder and image is compared with the last one on the card, and the larger of the two is utilized as the basis for new images.

1 In the [M] (Set up) menu, select [File Numbering].

See *Selecting Menus and Settings (Basic Guide)*: p. 16).

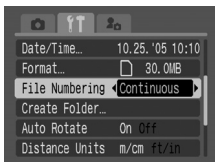

2 Use the ← or → button to select [Continuous] or [Auto Reset] and press the MENU button.

Settings can be made by turning the multi control dial.



- ◆ Setting the File Numbering to [Continuous] is useful for avoiding file name duplication when images are downloaded to a computer.

◆ File and Folder Numbers

Recorded images are assigned consecutive file numbers starting with 0001 and ranging up to 9999, while folders are assigned numbers starting with 100 and ranging up to 999. Up to 2,000 images can be saved into a single folder.

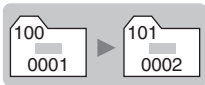
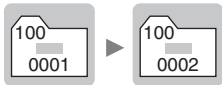
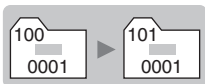
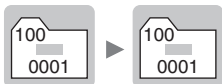
	New Folder Created	Memory Card Exchanged for Another
Continuous	<p>Memory Card 1</p> 	<p>Memory Card 1Memory Card 2</p> 
Auto Reset	<p>Memory Card 1</p> 	<p>Memory Card 1Memory Card 2</p> 

- ◆ Images may be saved to a new folder when there is insufficient free space even if the total number of images in a folder is less than 2,000 because the following types of image are always saved together into the same folder.
 - continuous shooting
 - self-timer (☑ option)
 - Stitch Assist mode images
 - My Colors ([Save Original] set to [On])
 - Shooting movies
- ◆ Images cannot be played back when the folder numbers are duplicated or image numbers are duplicated within folders.
- ◆ Please refer to the Software Starter Guide for information regarding folder structures or image types.

Create a save destination (folder)

You can create folders manually or automatically on the memory card used to save your pictures. You can create folders at regular intervals, making it easy to classify your pictures.

Create New Folder		A folder is created every time you shoot a set of pictures, and the pictures are stored there.
Auto Create	Off*	A folder is created every time the memory card contains 2000 pictures, and the pictures are stored there.
	Daily	A folder is created every day that you shoot pictures, and the pictures are stored there. Folders are not created if you do not shoot pictures.
	Monday to Sunday (Weekly)	A folder is created on the specified that and the pictures that you shot during that week are stored there. Pictures shot after the specified day are stored in a new folder. This process is repeated unless the number of pictures contained in a week exceeds 2000. Folders are not created if you do not shoot pictures.
	Monthly	A folder is created monthly, on the first day that you shoot pictures. The pictures taken that month are stored there, as long as their number does not exceed 2000. Folders are not created if you do not shoot pictures.

*Default setting

- Creation time: If you select [Daily], [Monday-Sunday (Weekly)], or [Monthly], you can also specify the time at which to create a folder. If you shoot pictures after the specified time, a new folder is created.

1 Select [Create Folder] in the [i] (Set up) menu and press the FUNC./SET button.

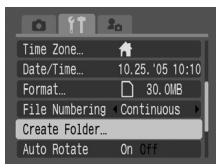

- 2** If you want to create a new folder, use the **←** or **→** button to select [Create New Folder].

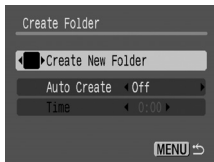

If you want to create a folder at a specific time, use the **↑** or **↓** button to select [Auto Create], then the **←** or **→** button to select [Off], [Daily], [Monday to Sunday], or [Monthly].

Settings can be made by turning the multi control dial.

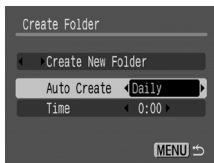

- 3** Use the **↑** or **↓** button to select [Time], and then the **←** or **→** button to specify a time.

Settings can be made by turning the multi control dial.

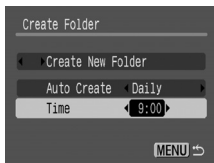

Before a folder is created automatically, the  appears on the LCD.

Magnifying Images

1 Press the  button.

2 Press the zoom lever toward .

You can cancel the magnified display by pressing the zoom lever toward .

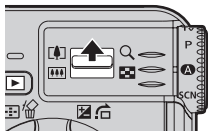

Magnified approximately 5 times







Approximate position of the magnified area

Magnified approximately 10 times



Approximate position of the magnified area

- You can change the magnification level with the zoom lever.
- You can move around the image using , ,  or  button.
- You can also cancel it immediately by pressing the **MENU** button.
- Movie frames and index playback images cannot be magnified.
- You can magnify an image while it is displayed on the LCD monitor immediately after the image is shot.
- When you turn the multi control dial, you select the previous or next image while still being zoomed.

Viewing Images in Sets of Nine (Index Playback)

1 Press the  button.

2 Press the zoom lever toward .

Nine images appear at once (index playback).

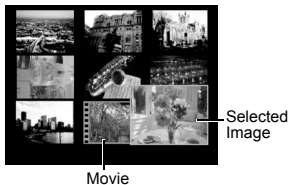
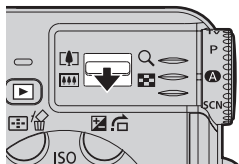

3 Change the image selection using the **↑**, **↓**, **←** or **→** button.

- Press the **DISP.** button to show the data for the selected image (p. 16).
- Even when you turn the multi control dial, you can still switch between images.

Pressing the **↑** arrow in this row displays the previous set of nine images.



Pressing the **↓** arrow in this row displays the next set of nine images.

4 Press the zoom lever toward **Q**.

Index playback cancels and the display reverts to single image playback.

The display jumps nine images at a time

1 In index playback mode (p. 88), press the **⏮** button.

- The jump bar will display.
- Even when the Zoom Lever is in the **Q** direction, you can still switch.

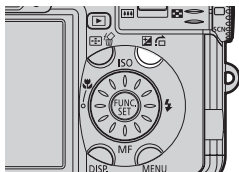

2 View the previous or next nine images using ◀ or ▶ button.

- You can select the images turning the multi control dial.
- Hold the **FUNC./SET** button down and press the ◀ or ▶ button to jump to the first or last set.

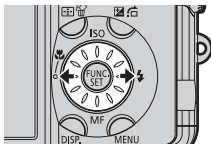





3 Press the ⏪ button.

- The jump bar disappears and the camera reverts to index playback.
- Even when the Zoom Lever is in the 🔍 direction, you can still switch.

⏪ Jumping to Images

When you have many images recorded onto a memory card, it is handy to use the four search keys below to jump over images to find the object of your search.

-  Jump 10 Images:jumps over 10 images at a time
-  Jump 100 Images:jumps over 100 images at a time
-  Jump Shot Date:jumps to the first image with the next shooting date
-  Jump to Movie:jumps to a movie (playback is available)
-  Jump folder: The first picture contained in all the folders containing pictures appears (p. 86).

1 In Single Image playback mode, press the ⏪ button.

The camera will switch to jump search mode.

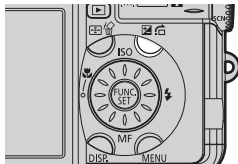

2 Use the \uparrow or \downarrow button to select the $\left[\frac{10}{100} \right]$, $\left[\frac{100}{10} \right]$, $\left[\frac{1000}{100} \right]$, $\left[\frac{10000}{1000} \right]$ or $\left[\frac{100000}{10000} \right]$ button, and press the \leftarrow or \rightarrow button.

- You can select the button turning the multi control dial.
- To change the search key, press the \uparrow or \downarrow button.
- The screen sample will vary slightly according to the search key.



Position of currently displayed image

To Return to Single Image Playback

Press the **MENU** button.

Triple Image Scrolling Display

1 When viewing an image, turn the multi control dial.

- Three images appear simultaneously. The one in the middle is displayed slightly larger than the other two.
- Turning the multi control dial clockwise or counterclockwise allows you to move to the next or previous image.
- If you do not perform any operations for a while, the display returns to single image display.

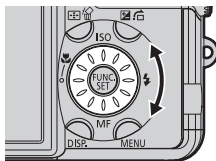

Order indicator
(Newest images are at bottom)

To Return to Single Image Playback

Press the **MENU** button.

Rotating Images in the Display

Images can be rotated clockwise 90° or 270° in the display.

0° (Original)



90°



270°



1 Select [Rotate] from the [▶] (Play) menu and press the SET button.

See *Selecting Menus and Settings (Basic Guide: p. 16)*.

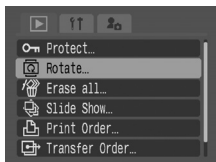

2 Use the ◀ or ▶ button to select an image you want to rotate and press the FUNC./SET button.

- The image cycles to the next orientation (90° → 270° → original) each time the **FUNC./SET** button is pressed.
- Settings can be made by turning the multi control dial.
- Settings can be made even in index playback mode.



- Movies cannot be rotated.
- When images are downloaded to a computer, the orientation of images rotated by the camera will depend upon the software used to download the images.



- ◆ Images can be magnified when rotated (p. 88).
- ◆ Images taken vertically with the auto rotate function (p. 83) set to [On] will automatically be rotated to the vertical position when viewed on the LCD monitor.

Applying Effects and Playing Back

You can apply such effects as fade in, and then play back your movies.

1 Select [Transition] on the [] (Playback) menu.

See *Selecting Menus and Settings (Basic Guide)*: p. 16).

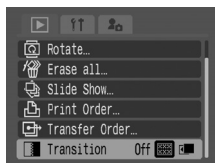



2 Use the or button to select Off, , or .

Settings can be made by turning the multi control dial.

Off: Play back the movie without applying effects.

: Allows you to apply a fade (fade-in) while transitioning between scenes.

: Allows you to apply a movement effect that transitions scenes right with the  button and left with the  button.



Viewing/Editing Movies

You can play back recorded movies and delete unwanted portions from the beginning or the end of movie clips.



- Protected movies cannot be edited.
- It may take some time to save an edited movie as a new file depending on the file size. If the batteries run out of charge partway through, edited movie clips cannot be saved. When editing movies, use separately sold, fully charged battery or AC Adapter Kit ACK-DC20 (sold separately).



You may experience frame dropping if you are using a slow memory card and recording with high resolution and frame rate settings.

- 1 Select a movie in the Playback mode and press the FUNC./SET button.**



This mark appears on movie files

- 2 Use the ← or → button to select one of the following operations, then press the FUNC./SET button.**

You can also use the multi control dial to make your selection.

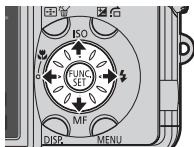

Movie Control Panel

(Exit): Back to the screen in Step 1

(Print): Movies can be printed. See the *Direct Print User Guide* for details.

(This icon appears when a printer is connected)

(Play): Starts playback of movies and sound

(Slow Playback): During slow playback, playback speed can be changed by ← or →. ← speeds up and → slows down.



Movie Control Panel

Playback Sound Level

(You can also make modifications when turning the multi control dial.)

- (First Frame): Shows the first frame
- (Previous Frame): Rewinds if the **FUNC./SET** button is held down
- (Next Frame): Fast forwards if the **FUNC./SET** button is held down
- (Last Frame): Shows the last frame
- (Edit): Edits the movie → Step 3

Playback and Slow Motion Playback Operations

	Playback	Slow Motion Playback
: Adjusts the volume during playback.	○	×
FUNC./SET : Pauses playback Press again to resume playback	○	○

- ○: Operations can be performed.
- The audio cannot be played in slow motion playback.
- Volume at which movies play back can be adjusted in the [] (Set up) menu (p. 29).

When Playback Ends

The last frame remains displayed when playback ends.

FUNC./SET: Displays the movie playback panel.

Press again to play back the movie again from the first frame.

- You may experience frame dropping and audio breakup when playing back a movie on a computer with insufficient system resources.
- Please adjust the audio sound level on the TV when viewing movie files on a TV.
- If you are not editing the movie, operations end here.

3 After selecting (Edit), use the or button to select (Cut Beginning) or (Cut End) from the movie editing panel.

(Cut Beginning): Deletes frames in the first half of the movie

Use the or button, or the multi control dial to select a position.

(Cut End): Deletes frames in the second half of the movie

Use the or button, or the multi control dial to select a position.

(Play): Plays back the temporarily edited movie

(Save): Saves the movie

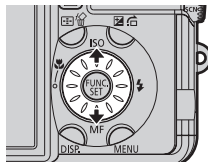

 (Exit): Cancels movie editing and reverts to the screen in Step 2. Movies with an original length of 1 second or more can be edited in 1 second units.

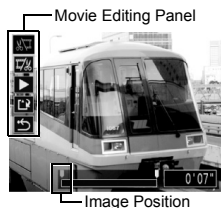



4 Use the  or  button to select an image at the position to be deleted, select  (Play) with the  or  button, and press the FUNC./SET button.

The temporarily edited movie will start playing.

- The movie will stop if you press the **FUNC./SET** button while it is playing.
- Repeat Steps 3 and 4 to continue editing.

5 Use the  or  button to select  (Save) and press the FUNC./SET button.

When you select  (Exit) and select [OK] using the  or  button (or you can select it by turning the multi control dial), the edited movie is not saved and the camera reverts to the screen in Step 2.

6 Use the , ,  or  button to select [Overwrite] or [New File] and press the FUNC./SET button.

- You can select it by turning the multi control dial.

Overwrite:Saves the edited movie with its original name. The pre-edit data is lost.

New File:Saves the edited movie under a new file name. The pre-edit data is left unchanged.

Cancel:Reverts to the screen in Step 3 without saving.

When there is not enough space left on the memory card, only the overwrite function is available. If this happens,  appears on the counter of the movie editing bar.



- Movies recorded at 640 × 480 or 320 × 240 pixels (30 f/s) and with the video signal set to the PAL format may play back with a frame rate lower than the recorded rate when output to a TV or video. You can play every frame by using the slow motion playback. To check the images at the original frame rate, you are recommended to play the movie back on the camera's LCD monitor or on a computer.
- Movies shot with other cameras may not be played back or edited on this camera. See *List of Messages* (p. 122).

Attaching Sound Memos to Images

In Playback mode (including single image playback, index playback, magnified playback and the review immediately after shooting in Shooting mode) you can attach sound memos (up to 60 seconds) to an image. The sound data is saved in the WAVE format.

1 Press the button while playing back images.

The sound memo control panel will display.





2 Use the or button to select (Record) and press the **FUNC./SET** button.

- You can select it by turning the multi control dial.
- The recording starts and the elapsed time is displayed. Speak towards the microphone of the camera.
- To stop playback, press the **FUNC./SET** button. To restart recording, press the **FUNC./SET** button again.
- You can add as many sound memos as you like until their total time reaches 60 seconds.
- If the memory card becomes full during recording, the camera emits a sound to inform you, and recording stops automatically.











Sound Memo Panel

Playing back the Sound Memos

- Select . Images with sound memos are displayed with the  mark. To stop playback, press the **FUNC./SET** button. To restart playback, press the **FUNC./SET** button again. You can adjust the volume with the  or  button.

Erasing the Sound Memos

- Verify that  is displayed, select  with the  or  button, and press the **FUNC./SET** button. Use the  or  button to select [Erase] and press the **FUNC./SET** button.
- You can select it by turning the multi control dial instead of the  or  button.



Exiting the Sound Memos Menu

- Press the  button.



- You cannot attach sound memos to movies.
- The "Memory card full" message will display when the memory card is full and you will be unable to record sound memos to that card.
- You cannot record or playback sound memos for images that already have an incompatible sound file attached. If you attempt to record or play such images, the "Incompatible WAVE format" message will display. Incompatible sound files can be deleted with this camera.
- Sound memos for protected images cannot be erased. (p. 104)









- ◆ The volume can be adjusted in the Set up menu (p. 29).
- ◆ If you set [Mute] to [On] in the Set up menu, no sound is reproduced, however, you can resume the sound and adjust the volume by pressing the  or  button.

Automated Playback (Slide Shows)

Slide show image settings are based on DPOF standards (p. 110).

Starting a Slide Show









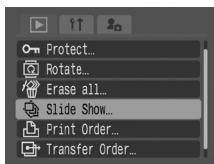

A selection of images or all the images on an memory card can be displayed one- by-one in an automated slide show.



	All Images	Plays all images on the memory card in order.
	Date	Starts the slideshow from the specified date, in the order taken.
	Folders	Uses the images in the specified folder, and displays them in their folder order.
	Movies	Uses all the movies on the specified memory card.
	Still Images	Uses all the images on the specified memory card.
	Custom 1-3	Mark only the images that you would like to see in the slideshow and save the selections in [Custom 1], [Custom 2], or [Custom 3]. You can select up to 998 images for each custom slideshow.

1 In the [ (Play)] menu, select [Slide Show] and press the FUNC./SET button.





- See *Selecting Menus and Settings (Basic Guide: p. 16)*.
- The Slide Show menu will display.

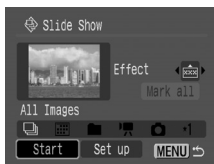

2 Select from , , , ,  or one of  -  with the , ,  or  button.

- See from Step 3 of "Select images for the Slide Show" (p. 100) to select images for  (Custom 1) to  (Custom 3).
- Settings can be made by turning the multi control dial.



3 When you select  [Date] or  [Folder], press the FUNC./SET button, and then using the  or  arrow buttons to select the desired files or folders, and then press the MENU button again.

Settings can be made by turning the multi control dial.

4 Use the **↑** or **↓** button to select [Start] and press the **FUNC./SET** button.

The slide show starts. The Slide Show menu will reappear after the playback ends.

Pausing/Resuming a Slide Show

- Press the **FUNC./SET** button to pause the show (|| appears). Press it again to resume.

Slide Show Forward/Reverse

- Use the **←** or **→** button to move to the previous or next image.
- Also use the multi control dial to move to the previous or next image.

Stopping a Slide Show

- Press the **MENU** button during a slide show to stop it and display the slide show menu.

5 When the slide show is over, press the **MENU** button.

The slide show menu appears again. Press the **MENU** button again to return to the play menu.



- ◆ During single image playback, simultaneously pressing the **FUNC./SET** and **↶↷** buttons begins a slideshow from the first image. However, if you do this when the last taken image is displayed, playback begins by the first image taken the same day as the one displayed.
- ◆ Movies play for their entire recorded length regardless of the slide show time settings (p. 102).
- ◆ The power saving function is disabled while a slide show plays on the camera (p. 21).

Select images for the Slide Show

You can mark images for inclusion in **•1** (Custom 1) to **•3** (Custom 3). Up to 998 images may be marked per slide show. Images display in the order of their selection.

1 Display the slide show menu (p. 99), use the **↑** or **↓** button and select **All Images**.

2 Select ***1** (Custom 1), ***2** (Custom 2) or ***3** (Custom 3) with the **←** or **→** button and press the **FUNC./SET** button.

- A checkmark (✓) will appear beside a show already containing images.
- Only ***1** (Custom 1) is displayed in the default settings.
- Settings can be made by turning the multi control dial.
- When selecting all images at once, use the **↑** or **↓** button to select [Mark All], then press the **FUNC./SET** button. Furthermore, select [Mark all] with the **↑** or **↓** button, press the **FUNC./SET** button, select [OK] with the **←** or **→** button and then press the **FUNC./SET** button. Also, return to ***1**, ***2**, or ***3** with the **↑** or **↓** button, then press the **FUNC./SET** button to deselect images specified by the method in Step 3. Specified images can be selected or deselected even after a [Reset] is performed.



3 Select images for the Slide Show.

Single Image Playback

- Select an image with the **←** or **→** button and select (or deselect) by pressing the **FUNC./SET** button.
- The selection number and a check mark (✓) appear in the upper part of selected images.
- Press **⏮** to display the Jump Bar (p. 90). After jumping and pressing the **MENU** button, press the **FUNC./SET** button to select or deselect images.



Index Playback

- Press the zoom lever toward **⏏** to switch to index playback (9 images).
- Use the **↑**, **↓**, **←** or **→** button to select an image and select (deselect) by pressing the **FUNC./SET** button.
- The selection number and a check mark (✓) appear at the bottom of selected images.



4 Press the **MENU** button.

The image selection screen will close.

Adjusting the Play Time and Repeat Settings

Play Time	Sets the amount of time for each image to be displayed in the slide show. Choose between 3-10 seconds, 15 seconds and 30 seconds.
Repeat	Sets whether the slide show stops when all the slides have been displayed or continues until stopped.

1 Display the slide show menu (p. 99).

2 Use the **←** or **→** button to select [Set up] and press the **FUNC./SET** button.



3 Use the **↑** or **↓** button to select [Play Time] or [Repeat], and set with the **←** or **→** button.

Settings can be made by turning the multi control dial.

Play Time

- Select a play time.

Repeat

- Select [On] or [Off].

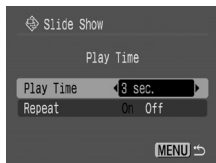

4 Press the **MENU** button.





The Setup menu closes.



Depending on the images, the display interval may vary slightly from the setting when played.

Configuring Effects

When the following screen appears, you can apply effects on your slideshow.

	Playback begins automatically without using effects.
	Applies a down-up fade of the image, the image appears from the bottom up.
	At first, a cross appears on the image and the image appears gradually.
	The image gradually appears horizontally.



1 Display the slide show menu (p. 99).

2 Use the \uparrow or \downarrow button to select [Effect].



3 Use the ← or → button to select

Off, ,  or .

- Settings can be made by turning the multi control dial.
- The Setup menu closes.



Protecting Images



You can protect important images from accidental erasure.

1 In the [▶] (Play) menu, select [Protect] and press the FUNC./SET button.

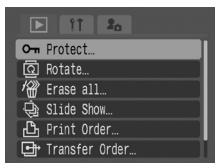
See *Selecting Menus and Settings (Basic Guide)*: p. 16).



2 Use the ← or → button to select an image you want to protect and press the FUNC./SET button.

- The  icon appears on protected images.
- To remove the protection, press the **FUNC./SET** button again (in protection mode).
- You can make the selection of images easier by toggling between single image playback and index playback with the zoom lever.
- During index playback, press the zoom lever toward  to jump nine images at a time. To select or deselect images, press the zoom level toward  to remove the Jump Bar (p. 89), then proceed.
- Settings can be made by turning the multi control dial.



Please note that formatting (initializing) a memory card erases all data (p. 23), including protected images and other file types. Please check the contents of a memory card before formatting it.

Erasing All Images

Please note that erased images cannot be recovered. Exercise adequate caution before erasing a file.

- 1** Select [Erase all] from the [▶] (Play) menu and press the FUNC./SET button.

See *Selecting Menus and Settings (Basic Guide: p. 16)*

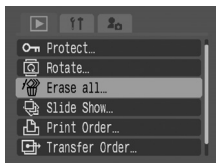

- 2** Use the ← or → button on the multi control dial to select [OK], then press the FUNC./SET button.

- To cancel instead of erasing, select [Cancel].
- Settings can be made by turning the multi control dial.

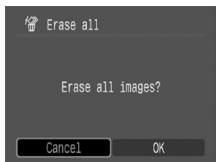

- ◆ You should format the memory card when you want to erase not only image data but also all the data contained on the card (p. 23)
- ◆ Protected images cannot be erased with this function (p. 104).

About Printing

Images shot with this camera can be printed using one of the following methods.

- Connecting the camera to a direct print compatible printer*¹ with an interface cable and pressing the  button on the camera.
- You can specify the images on your memory card you want to print and how many copies you want (DPOF*² Print Settings), and then take the memory card to a participating photo lab that supports DPOF to have them printed out later.

*1 Since this camera uses a standard protocol (PictBridge), you can use it with other PictBridge-compliant printers in addition to Canon-brand compact photo printers (SELPHY CP series) and Bubble Jet Printers (PIXMA series/SELPHY DS series).

*2 Digital Print Order Format

This manual explains the DPOF print settings. For information on how to print images, refer to the Camera User Guide (Basic) and *Direct Print User Guide* supplied with the camera. Also, refer to *your printer's manual*.

Please check the System Map to confirm the compact photo printer (SELPHY CP series) and Bubble Jet Printers (PIXMA series/SELPHY DS series) that can be used with this camera.

Setting the DPOF Print Settings

You can select images on an memory card for printing and specify the number of print copies in advance using the camera. This is extremely convenient for sending the images to a participating photo lab or for printing on a direct print function compatible printer.

See the *Direct Print User Guide* for instructions on how to print.



- **⚠ is displayed with memory card images that have had print settings set by other DPOF-compliant cameras. These settings will be overwritten by those set by your camera.**
- **The output of some printers or photo developing services may not reflect the specified print settings.**
- **Print settings cannot be set for movie images.**

Selecting Images for Printing

There are two ways to select images.

- Singly
- All images on a memory card

1 In the [(Play)] menu, select [Print Order] and press the SET button.

See *Selecting Menus and Settings* (Basic Guide: p. 16).

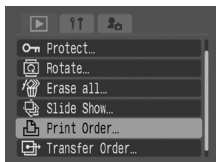



2 Use the , , or button to select [Order] and press the FUNC./SET button.

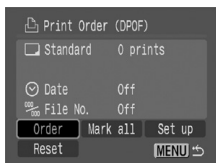

- You can select it by turning the multi control dial.
- All print settings for the image are canceled when you select [Reset].





3 Select images for printing.

Single Images

- When the print type (p. 108) is set to [Standard] or [Both], select an image with the  or  button.

Press the **FUNC./SET** button, specify the number of copies to print with  or , and press **FUNC./SET** again. (Up to 99 copies can be specified).

You can select the number of copies by turning the multi control dial.



- When the print type is set to [Index] (p. 108), choose an image using the  or  button and press the **FUNC./SET** button to select and deselect.

- When you press the  button, the Jump Bar is displayed to help with searching



Number of print copies



(p. 90). Press the **MENU** button and remove the Jump Bar, then press the **FUNC./SET** to select and deselect images.

- After changing to Index playback (nine-image display) by pressing the zoom lever to the  side, you can select images in the same way (if you press the zoom lever to the  side again, the camera jumps nine images at a time. Before selecting or deselecting, press the zoom lever to  to remove the Jump Bar).

All images on a memory card

- Select [Mark All] as in Step 2, and press the **FUNC./SET** button. Select [OK] with the  or  button, and press the **FUNC./SET** button.



4 Press the MENU button.





The selection mode will turn off and the Print Order menu will reappear.



- ◆ Images are printed in order from oldest to newest by the shooting date.
- ◆ A maximum of 998 images can be selected per memory card.
- ◆ When [Both] is selected, the number of print copies can be set, but it applies to Standard prints only. The [Index] setting only produces one print copy.

Setting the Print Style

The following print settings can be selected.

Print Type	 Standard	Prints one image per page.
	 Index	Prints the selected images together at a reduced size in an index format.
	 Both	Prints the images in both the standard and index formats.
 Date	Adds the date to the print.	
 File Number	Adds the file number to the print.	

- 1** In the [(Play)] menu, select [**Print Order**] and press the **FUNC./SET** button.

See *Selecting Menus and Settings* (Basic Guide: p. 16).

You can select it by turning the multi control dial.

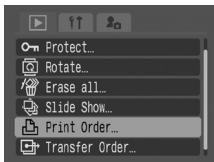

- 2** Use the **↑**, **↓**, **←** or **→** button to select [**Set up**] and press the **FUNC./SET** button.

- All print settings for the image are canceled when you select [**Reset**].
- Settings can be made by turning the multi control dial.

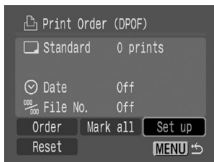

- 3** Use the **↑** or **↓** button to select [**Print Type**], [**Date**] or [**File No.**] and select settings with the **←** or **→** button.

Print Type

- Select [**Standard**], [**Index**] or [**Both**].

Date

- Select [**On**] or [**Off**].

File No.

- Select [**On**] or [**Off**].

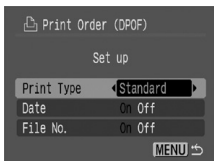

- 4** Press the **MENU** button.

The Setup menu closes and the Print Order menu reappears.



- When [**Print Type**] is set to [**Index**], the [**Date**] and [**File No.**] cannot be set to [**On**] at the same time.
- If you selected [**Standard**] or [**Both**] as the [**Print Type**], you can also set the [**Date**] and [**File No.**] settings to [**On**] at the same time. However, the data that is supported may vary among printers.



The date prints as the date and time in the format specified in the Set [**Date/Time**] menu (p. 30).

Image Transmission Settings (DPOF Transfer Order)

You can use the camera to specify settings for images before downloading to a computer. Refer to the *Software Starter Guide* for instructions on how to transfer images to your computer.

The settings used on the camera comply with the Digital Print Order Format (DPOF) standards.

! **⚠** may appear on memory card images that have had transfer marks set by another DPOF-compliant camera. These settings will be overwritten by any transfer marks set by your camera.

Selecting Images for Transferring

There are two ways to select images.

- Singly
- All images on a memory card

1 In the [**▶**] (Play) menu, select [Transfer Order] and press the SET button.

See *Selecting Menus and Settings* (Basic Guide: p. 16).

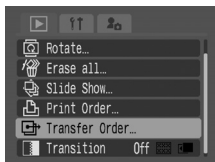



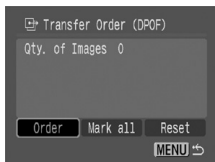

2 Use the **←** or **→** button to select [Order] and press the FUNC./SET button.

- All transfer settings for the image are canceled when you select [Reset].
- You can select it by turning the multi control dial.



3 Select images for transferring.

Single Images

- Select an image with the ◀ or ▶ button and mark or remove marks from images using the **FUNC./SET** button. A checkmark displays on selected images.
- When you press the  button, the Jump Bar is displayed to help with searching (p. 90). Press the **FUNC./SET** button after the **MENU** button to select and deselect, and to remove the Jump Bar.
- After changing to Index playback (nine-image display) by pressing the zoom lever to the  side, you can select images in the same way (if you press the zoom lever to the  side again, the camera jumps nine images at a time. Before selecting or deselecting, press the zoom lever to  to remove the Jump Bar).



All images on a memory card

- Select [Mark All] as in Step 2, and press the **FUNC./SET** button. To select all images, select [OK] with the ◀ or ▶ button, and press the **FUNC./SET** button.
- To cancel all print selections, select [Reset].



4 Press the MENU button.

The selection mode will turn off and the Transfer Order menu will reappear.



- ◆ Images are transferred in order from oldest to newest by the shooting date.
- ◆ A maximum of 998 images can be selected per memory card.

Viewing Images on a TV Set

You can use a video-compatible television as a monitor to shoot or play back images when it is connected to the camera with the supplied AV Cable AVC-DC300.

1 Turn off the camera and the TV.

2 Connect the AV Cable to the camera's A/V OUT terminal.

Slide the camera's DIGITAL terminal cover in the direction of the ◀ to open it, and plug the AV Cable in all the way.

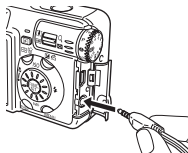

3 Plug the other ends of the A/V Cable into the VIDEO IN and AUDIO IN jacks on the TV.

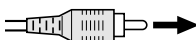

To the Video IN Jack Plug (Yellow)

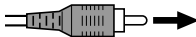

To the Audio IN Jack Plug (Black)

4 Turn on the TV and switch it to Video mode.

5 Power on the camera in Shooting mode or Playback mode.

- The image will appear on the TV. Shoot or play back images as usual.
- Press the **DISP.** button when images are not being displayed on the TV when shooting.



- ◆ No image will appear on the LCD monitor when the camera is connected to a TV monitor.
- ◆ If the TV is a stereo model, you can plug the audio plug into either the left or right Audio In jack. Please refer to the TV's manual for details.
- ◆ Refer to (p. 31), for *instructions regarding the video output signal*.
- ◆ A TV set cannot be used in the  (Stitch Assist) mode.

Customizing the Camera (My Camera Settings)

My Camera allows you to customize the start-up image and start-up, operation, self-timer and shutter sounds. Each menu item has three choices.





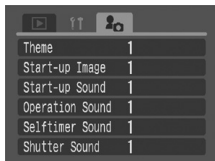

Changing My Camera Settings

1 Press the MENU button and press the \rightarrow button twice.

The  (My Camera) menu appears.



2 Use the \uparrow or \downarrow button to select a menu item, then select setting content with the \leftarrow or \rightarrow button.

- You can select a consistent theme for all My Camera settings by selecting [Theme] at the top.
 -  : Off (no display or sound produced)
 -  : General
 -  : Science fiction theme
 -  : Animal theme
- The contents of the  and  options can be changed (p. 114).
- Settings can be made by turning the multi control dial.

3 Press the MENU button.

The menu closes and settings are activated.



If [Mute] in the  (Set up) menu is set to [On], no sound is reproduced except for the error warning signal regardless of the selected My Camera settings. The Start-up image displays (p. 29).

Registering My Camera Settings

New content can be registered to  and .

Images and sounds recorded on the memory card can be added as My Camera settings. You can also use the supplied software to upload your computer's images and sounds to the camera.

The following menu items can be saved to the camera.

- Start-up Image
- Start-up Sound
- Operation Sound
- Self-timer Sound
- Shutter Sound

The memory card images can be registered to the camera with the following procedures.

1 Press the (Playback) button.

Registration is inhibited while in Shooting mode.

2 Press the MENU button and press the button twice.

The [ (My Camera)] menu appears.

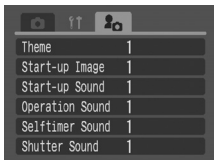



3 Use the or button to select the menu item you wish to register and select or with the or button.

[DISP.]  appears.

4 Press the DISP. button.

The start-up image screen or the sound recording menu appears.

Registering a Start-up Image

Use the  or  button to select the image you wish to register and press the FUNC./SET button.



Registering Sounds for Start-Up, Operations, Self-Timer and the Shutter

Use the **←** or **→** button to select  (Record) and press the **FUNC./SET** button.

- You can select it by turning the multi control dial.
- Recording will start and automatically stop when the time is exceeded. Recording times for each item are as follows:

Start-up Sound: 1 sec.

Operation Sound: 0.3 sec.

Self-timer Sound: 2 sec.

Shutter Sound: 0.3 sec.

- Use the **←** or **→** button to select  (Register) and press the **FUNC./SET** button.

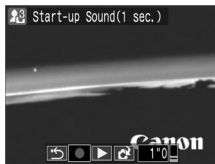

5 Use the **←** or **→** button to select [OK] and press the **FUNC./SET** button.

- You can select it by turning the multi control dial.



- **Movies and sounds recorded using the Sound Memo function (p. 97) cannot be registered as My Camera settings.**
- **The prior setting is erased when a new My Camera setting is added.**



A computer is required to restore the My Camera Settings to the defaults. Use the supplied software (ZoomBrowser EX/ImageBrowser) to add the default settings to the camera.

Data that can be Registered as My Camera Settings

My Camera settings should conform to the data types below. Memory card images shot with this camera in any of the following formats can be registered:

- **Start-up Image**
 - Compression Method: JPEG (Baseline JPEG)
 - Sampling Rate: 4:2:0 or 4:2:2
 - Dimensions: (320 x 240 pixels)
- **Start-up, Operation, Self-timer and Shutter Sounds**
 - Compression Method: WAVE (monaural)
 - Quantization Bits: 8 bit
 - Sampling Frequency: 11.025 kHz or 8.000 kHz

- Recorded Length

	11.025kHz	8.000kHz
Start-up Sound	1.0 sec. or less	1.3 sec. or less
Operation Sound	0.3 sec. or less	0.4 sec. or less
Self-Timer Sound	2.0 sec. or less	2.0 sec. or less
Shutter Sound	0.3 sec. or less	0.4 sec. or less

Any data types other than those described above cannot be used with this camera.

An example of this function is to record "Say Cheese" as a self-timer sound so that the camera will replay this sound 2 seconds before the photo is taken. You could also record cheerful music to bring out the natural smiles of your subjects, or so they can strike a pose fitting the music.





See the supplied *Software Starter Guide* for more information on creating and adding to the My Camera data.

Troubleshooting

Camera will not operate.

Power is not turned on.	<ul style="list-style-type: none">● Turn on the camera. → See <i>Turning the Power On/Off (Basic Guide: p. 4)</i>
Memory card slot/ battery cover opened.	<ul style="list-style-type: none">● Confirm that the memory card slot/battery cover are securely closed.
Insufficient battery voltage.	<ul style="list-style-type: none">● Fully charge the battery, then put it in the camera.● Use the Compact Power Adapter (sold separately).
Poor contact between camera and battery terminals.	<ul style="list-style-type: none">● Wipe the terminals with a clean, dry cloth.

Camera will not record.

Camera is in Playback or computer/printer connection mode.	<ul style="list-style-type: none">● Switch to Shooting mode.● During a computer or printer connection, disconnect the interface cable before switching the camera to Shooting mode.
Flash is charging. (Blinking  on LCD monitor).	<ul style="list-style-type: none">● Wait until  stops blinking and lights steadily, signaling that the flash is charged, then press the shutter button.
Memory card full.	<ul style="list-style-type: none">● Insert a freshly formatted (initialized) memory card.● If required, download the images to a computer and erase them from the memory card to make space.
Memory card not formatted correctly.	<ul style="list-style-type: none">● Formats (initializes) memory cards. → See <i>Formatting a Memory Card (p. 23)</i>● If reformatting doesn't work, the memory card logic circuits may be damaged. Consult the nearest Canon Customer Support Help Desk.
SD card is write-protected.	<ul style="list-style-type: none">● Slide the write-protect tab of the SD card upward. → See <i>Handling the Memory Card (p. 127)</i>

Cannot play back.

You attempted to play back images shot with another camera or images edited with a computer.	<ul style="list-style-type: none">● Computer images that cannot otherwise be played back might play back if they are sent to the camera using the bundled ZoomBrowser EX or ImageBrowser software. See <i>ZoomBrowser EX/ImageBrowser Software User Guide (PDF)</i>.
File name was changed with a computer or file location was changed.	<ul style="list-style-type: none">● Set the file name or file number according to the Design rule for Camera File system standards. → See <i>File and Folder Numbers (p. 85)</i>

Lens will not retract.

Memory card slot/battery cover was opened with camera on.	<ul style="list-style-type: none">● Close the memory card slot/battery cover, then turn off the camera.
Switched to Playback mode from Shooting mode.	<ul style="list-style-type: none">● The lens does not retract in this case. To make the lens retract, close the lens cover.

Batteries consumed quickly.

Battery performance deteriorates at low temperatures.	<ul style="list-style-type: none">● If shooting in a cold area, keep the batteries warm (by placing them in an inner pocket, etc.) until ready to use them.
Battery terminals are dirty.	<ul style="list-style-type: none">● Wipe them well with a dry cloth before use.
Battery pack capacity reduced because of disuse for one year or more after being fully charged.	<ul style="list-style-type: none">● Replace the battery pack with a new one.
Battery life exceeded if battery pack loses its charge quickly at normal temperature (23 °C/73 °F).	<ul style="list-style-type: none">● Replace the battery pack with a new one.

Battery pack does not charge.

Poor electrical contact.	<ul style="list-style-type: none">● Be sure to set battery pack firmly into the charger.
Battery terminals are dirty.	<ul style="list-style-type: none">● Wipe them well with a dry cloth before charging.
Battery life exceeded.	<ul style="list-style-type: none">● Replace the battery pack with a new one.

Sounds come from the camera interior.

The camera's horizontal/vertical orientation was changed.	<ul style="list-style-type: none">● The camera's orientation mechanism is operating. There is no malfunction.
---	---

Image is blurred or out of focus.

Camera moved.	<ul style="list-style-type: none"> ● Be careful not to move the camera while pressing the shutter button. ● Use a tripod at slow shutter speeds when the camera shake warning  blinks.
Autofocus function hampered by obstruction to AF-assist Beam.	<ul style="list-style-type: none"> ● Be careful not to block the AF-assist Beam with fingers or other items.
AF-assist Beam is set to [Off].	<ul style="list-style-type: none"> ● Set the AF-assist Beam to [On] (p. 27).
Subject is out of focal range.	<ul style="list-style-type: none"> ● For normal shooting conditions, stay at least 44 cm (1.4 ft.) away from the subject. ● Use the macro mode to shoot close-ups between 4 and 44 cm (1.6 in. and 1.4 ft.) at maximum wide angle and 30 and 44 cm (1.0 ft. and 1.4 ft.) from the front of the lens at maximum telephoto.
The subject is hard to focus on.	<ul style="list-style-type: none"> ● Use the focus lock, AF lock or manual focus to shoot. → See <i>Shooting Problem Subjects for the Autofocus</i> (p. 62)

Subject in recorded image is too dark.

Insufficient light for shooting.	<ul style="list-style-type: none"> ● Set the flash to on.
Subject is dark in contrast to the background.	<ul style="list-style-type: none"> ● Set the exposure compensation to a positive (+) setting. ● Use the AE lock or spot metering function. → See <i>Locking the Exposure Setting (AE Lock)</i> (p. 65) → See <i>Switching between Metering Modes</i> (p. 68)
Subject is too far away for flash to reach.	<ul style="list-style-type: none"> ● To use the built-in flash, shoot within the following ranges for flash shooting: Auto ISO: 55 cm to 4.2 m (1.8 ft. to 13.8 ft.) of the subject at the maximum wide angle and within 55 cm to 2.0 m (1.8 to 6.6 ft.) at the maximum telephoto setting. ● Raise the ISO speed and then shoot. → See <i>Changing the ISO Speed</i> (p. 74)

Subject in recorded image is too bright.

Subject is too close, making the flash too strong.	<ul style="list-style-type: none">● To use the built-in flash, shoot within correct range of the subject for flash photography.● Adjust the flash output or the flash exposure compensation function (p. 77).
Subject is bright in contrast to the background.	<ul style="list-style-type: none">● Set the exposure compensation to a negative (-) setting.● Use the AE lock or the spot metering function.<ul style="list-style-type: none">→ See <i>Locking the Exposure Setting (AE Lock)</i> (p. 65)→ See <i>Switching between Metering Modes</i> (p. 68)
Too much light is shining directly into the camera, or is being reflected off the subject.	<ul style="list-style-type: none">● Change the shooting angle.
Flash set to On.	<ul style="list-style-type: none">● Set the flash to Auto or Off.

A bar of light (red, purple) appears on the LCD monitor.

Subject is too bright.	<ul style="list-style-type: none">● This is a normal occurrence in devices containing CCDs and does not constitute a malfunction. (This red bar of light will not be recorded when shooting still photos, but it will be recorded when shooting movies.)
------------------------	--

Noise displays on the LCD monitor. Subject's movements on LCD monitor are irregular.

Camera automatically lightened the image displayed on the LCD monitor to make it easier to see when shooting in a dark area.	<ul style="list-style-type: none">● There is no effect on the recorded image.<ul style="list-style-type: none">→ See <i>Night Display</i> (p. 16)
--	---

White dots appear on the image.

Light from the flash has reflected off dust particles or insects in the air. This occurs more frequently in the following conditions:

- When shooting at the maximum wide angle.
- When shooting with a high aperture value in the aperture-priority AE mode.

- This is a phenomenon that occurs with digital cameras and does not constitute a malfunction.

Flash does not fire.

Flash set to Off.

- Set the flash to On.
→ See *Using the Flash* (*Basic Guide*: p. 13)

Image not showing on TV monitor.

Incorrect video system setting.

- Set the video system to the appropriate setting, NTSC or PAL, for your TV.

Shooting mode set to  (Stitch Assist).

- The output will not appear on a TV monitor in  (Stitch Assist) mode. Cancel the Stitch Assist mode.

Zoom does not operate.

Zoom lever was moved while shooting in movie mode.

- Operate the zoom before shooting in movie mode (*Basic Guide*: p. 12). However, digital zoom can also be used during shooting (only in standard mode) (p. 39).

Reading images from the memory card is slow, or recording images to the memory card takes a long time.

Memory card was formatted in another device.

- Use a memory card formatted with this camera.
→ See *Formatting a Memory Card* (p. 23)

The Date/Time menu appears.

The built-in rechargeable lithium battery charge is low.

- Replace it at once with a charged battery (*Basic Guide*: p. 4).

List of Messages

The following messages may appear on the LCD monitor (or viewfinder) during shooting or playback.

Please refer to the *Direct Print User Guide* for the messages that display during a printer connection.

Busy...

Image is being recorded to, or read from, memory card.

Playback mode is starting.

Resetting all the camera and menu settings to default.

No memory card

You attempted to shoot or play back images without a memory card installed.

Card locked!

SD card is write-protected. (p. 104)

Cannot record

You attempted to shoot an image without a memory card installed.

Memory card error!

Memory card has experienced an anomaly.

Memory card full

Memory card is full of images or sounds and no more can be recorded or saved. Also, no more image settings (such as slide show and print settings) or sound memos can be recorded.

Naming error!

The image could not be created because there is an image with the same name as the directory that the camera is attempting to create, the highest possible file number has already been reached. In the Set up menu, please set [File Numbering] to [Auto Reset]. After you save all the images or sounds you wish to retain onto a computer, format the memory card (p. 23). Please note that formatting will erase all the existing images and other data.

Change the battery pack.

Battery charge is insufficient to operate the camera. Replace it at once with a charged one or recharge the battery.

No image.

No images recorded on memory card.

Image too large.

You attempted to play back an image larger than 4992 x 3328 pixels or with a large data size.

Incompatible JPEG format.

You attempted to play back an incompatible JPEG image.

Corrupted Data.

You attempted to play back an image with corrupted data.

RAW

You attempted to play back a RAW image.

Unidentified Image

You attempted to play back an image that was recorded in a special data type (proprietary data type used by the camera of another manufacturer, etc.) or a movie clip recorded by another camera.

Cannot magnify!

You attempted to magnify an image recorded in a different camera or data type, an image edited with a computer, or a movie.

Cannot rotate

You attempted to rotate an image recorded in a different camera or data type, an image edited with a computer, or a movie.

Incompatible WAVE format.

A sound memo cannot be added to this image since the data type of the existing sound memo is incorrect.

Cannot register this image!

You attempted to add a start-up image or a movie that was created with another camera.

Protected!

You attempted to erase or edit a protected image, movie or sound file.

Too many marks.

Too many images have been marked with print settings or transfer settings or slide show settings. Cannot process any more.

Cannot complete!

Could not save the print or transfer or slide show settings.

Unselectable image.

You attempted to set the print settings for a non- JPEG image.

Cannot edit

Slide show settings file is corrupted.

Exx

(xx: number) Camera malfunction. Turn the power off and then back on, then shoot or play back. A problem exists if the error code reappears. Note the number and contact your Canon Customer Support Help Desk. If an error code displays directly after taking a picture, the shot may not have been recorded. Check image in playback mode.

Battery Handling

Battery Status Indications

The following icons or messages indicate the battery status on the LCD monitor.

	Battery charge is low. Recharge it as soon as possible if it will be used for an extended period.
Change the battery pack	Battery charge is insufficient to operate the camera. Replace the battery immediately.



Battery Performance (p. 139)

Battery Handling Precaution



- ◆ This is a rechargeable lithium ion battery pack so there is no need to completely use or discharge it before recharging. It can be recharged at any time.
 - ◆ It takes approximately 90 minutes to bring a fully discharged battery pack to full charge (based on Canon's testing standard). Charging it within a temperature range of 5 - 40 °C (41 - 104 °F) is recommended. Charge times may vary according to the ambient temperature and the battery's charge state.
 - ◆ The use of the separately sold AC Adapter Kit ACK-DC20 is recommended to power the camera during long usage sessions (p. 128).
- Keep the battery terminals \oplus \ominus clean at all times. Dirty terminals may cause poor contact between the battery and camera. Polish the terminals with a soft cotton swab before charging or using the battery.
- Do not shake or place the battery charger upside down once the camera battery is in it, as this may cause the battery to fall, damaging it.
- Although the battery pack's maximum operating range is 0 to 40 °C (32 to 104 °F), the optimal range is 10 to 30 °C (50 to 86 °F). At cold temperatures, such as those experienced when skiing, performance will temporarily decline, reducing the usable time before recharging. Under these conditions, revive the battery by warming it in a pocket immediately before use. However, ensure that there are no metallic items in the pocket that could cause a short circuit, such as a key ring, etc.

- Do not cover the battery charger with anything, such as a tablecloth, cushion or blanket, when it is charging. Heat will build up internally and possibly lead to fire.
- Do not charge Battery other than Battery Pack NB-2LH/NB-2L (sold separately) with the supplied battery charger.
- The battery pack continues to discharge a small amount when left in the camera (even with the power turned off) or battery charger. This shortens the battery life. Remove the battery pack when the camera is not in use.
- Do not allow any metal objects such as keyrings to touch the ⊕ and ⊖ terminals (Fig. A), as this can damage the battery pack. To carry the battery pack, or store it during periods of disuse, always replace the terminal cover (Fig. B). When using Battery Pack NB-2LH, you can distinguish between a discharged battery pack and fully charged battery pack by changing the direction of the battery cover (Fig. C and D). Recharge the battery fully before using it again.

Fig.A

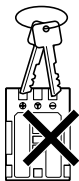

Fig.B

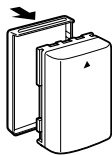
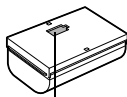

Fig.C

Fully Charged Battery



Insert the battery pack so the blue area is visible.

Fig.D

Used Battery

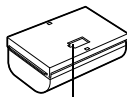

Attach in the opposite way of Fig. C.

- Even charged battery packs continue to discharge naturally. You are advised to charge the battery on the day of use, or one day before, to ensure a full charge.
- Since storing a fully charged battery pack for long periods of time (about 1 year) can shorten its lifecycle or affect performance, store the battery in an indoor location with low relative humidity and between the temperatures of 0 to 30 °C (32 to 86 °F). If you do not use the battery pack for long periods of time, charge it fully and discharge it fully in the camera at least once a year before returning it to storage.
- The camera consumes the battery charge when the power is on even when a function is not being used. To conserve the battery charge, be particularly attentive in turning the camera off.
- If the usable time of a battery pack diminishes substantially even when fully charged, it should be replaced.

Handling the Memory Card

Write Protect Tab

The SD memory card has a write-protect tab. Sliding the tab downward prevents recording of data and protects existing data (e.g. images). When recording to, erasing from or formatting the memory card, slide the tab upward.

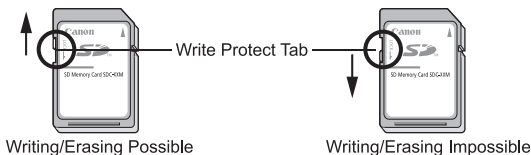

Ensure that the memory card is correctly oriented before inserting it in the camera. It may damage the camera if inserted backward by mistake.



Cautions When Handling

- ◆ Memory cards are high-precision electronic devices. Do not bend them, apply force to them, or subject them to shocks or vibration.
- ◆ Do not attempt to disassemble or alter the memory card.
- ◆ Do not allow dirt, water or foreign objects to contact the terminals on the back of the card. Do not touch the terminals with your hands or metal objects.
- ◆ Do not peel away the original label on the memory card or cover it with another label or sticker.
- ◆ When writing on the memory card, use a soft point pen (e.g. felt-tip pen). Using a sharp point pen (e.g. ball-point pen) or pencil may damage the memory card or corrupt the recorded data.
- ◆ Since some or all of the data recorded on the memory card may be corrupted or erased by electrical noise, static electricity, camera or card malfunction, making a backup copy of important data is recommended.
- ◆ Moving a memory card rapidly between temperature extremes will cause condensation to form in the card and lead to a malfunction. To avoid condensation, place the memory card in a sealed plastic bag before moving it into a different temperature zone and allow it to adjust slowly to the new temperature.
- ◆ If condensation forms on the memory card, store it at room temperature until the water droplets have evaporated naturally.
- ◆ Do not use or store memory cards in the following locations.
 - Locations subject to dust or sand
 - Locations subject to high humidity and high temperatures

Using the AC Adapter Kit (Sold Separately)

You are advised to use AC Adapter Kit ACK-DC20* (sold separately) for long periods of use and when connecting to a computer or printer.

* Consists of Compact Power Adapter CA-PS700, DC Coupler DR-20 and DR-700 (Not available on the PowerShot S80) and a power cord.

1 Attach the power cord to the compact power adapter (1) and plug it into a power outlet (2).

Plug in the power cord firmly as far as it will go.

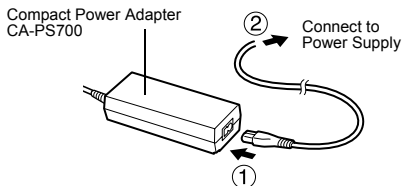

2 Connect the DC plug of the compact power adapter cable to the DC Coupler DR-20 terminal.

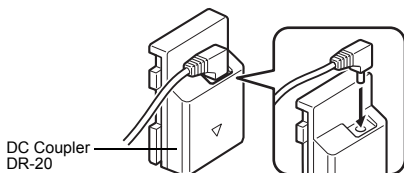

3 Open the memory card slot/battery cover, then insert the DC Coupler until it is locked.

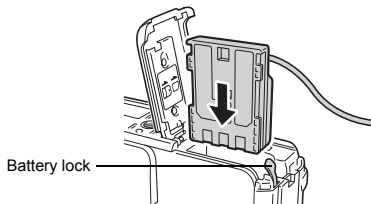

-
- 4** Press and hold the DC Coupler cable cover using the cable, then close the memory card slot/battery cover.

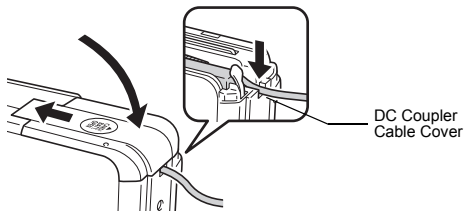

- Always disconnect the compact power adapter from the power supply after use.



- Always turn the camera's power off before connecting or disconnecting the compact power adapter.
- Using any device other than the AC Adapter Kit ACK-DC20 may damage the camera.
- Do not connect the AC Adapter Kit ACK-DC20 to any other devices. It could cause smoke and fire, or damage the Adapter.

Car Battery Charger (Sold Separately)

Car Battery Charger CBC-NB2 (sold separately) can be used to charge battery packs from an automobile's cigarette lighter socket. Always ensure that the automobile's engine is running when you use the car battery charger. Use of it with the engine off may flatten the battery in some automobiles. Always unplug the car battery charger before turning off the engine.

-
- 1** With the engine running, plug the car battery cable into the cigarette lighter socket.

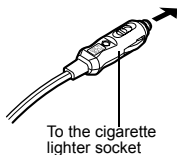

-
- 2** Insert the battery pack all the way into the battery charger as shown.

- Align the arrow on the battery pack and the arrow on the battery charger to correctly insert the battery pack in the charger.
- The charge indicator will light red while the battery pack is charging. It will change to green when the charge is complete.
- After charging, remove the battery pack and unplug the car battery cable from the cigarette lighter socket.

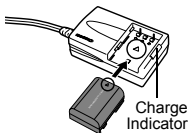

- The battery will stop charging whenever you turn the engine off, so be sure to unplug the car battery cable from the cigarette lighter socket.
- Wait until the engine is running again to plug the car battery cable into the cigarette lighter socket.
- The car battery charger can only be used in a negative ground car. It cannot be used in a positive ground car.

Using Conversion Lenses (Sold Separately)

The camera supports use of the separately sold Wideconverter WC-DC10 and Tele-converter TC-DC10. In order to attach this lens, you also need to use the separately sold Conversion Lens Adapter LA-DC20.

Warning

- When attaching the wide converter or tele-converter be sure to screw it on securely. If they come loose, they may fall from the lens adapter, posing risk of injury from shattered glass.
- Never look into the sun or into strong light through the wide converter or teleconverter as this can result in blindness or impairment of vision.



- The built-in flash cannot be used with a conversion lens attached.
- When using the tele-converter, set the camera near the maximum telephoto. At other zoom settings, the image will appear as if its corners have been cut off.
- Filters and lens hoods cannot be attached to the wide converter and tele-converter lens.
- You cannot use the viewfinder when the conversion lens adapter is attached.

Attaching a Lens

1 Open the lens cover to power up the camera.

2 Align the conversion lens adapter with the front of the camera, then attach the conversion lens adapter to the tripod screw hole.

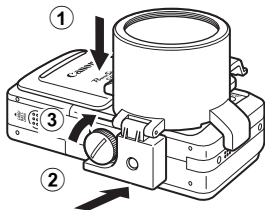

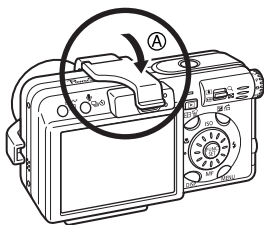

3 Ⓐ Move in the direction of the arrow and insert it into the viewfinder until it clicks into place.

- To remove the conversion lens adapter, follow the above steps in reverse order.

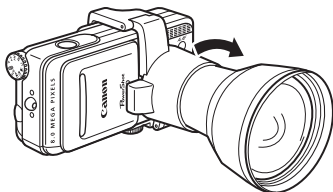

4 Turn the lens in the direction of the arrow to attach it.



- When attached to the camera, do not carry the camera by the conversion lens adapter, wideconverter or the tele-converter. The camera could detach, fall and break.
- To protect the conversion lens, hold the conversion lens adapter with one hand and screw the conversion lens onto the adapter with the other hand.
- You should not shoot images in  (Stitch Assist) mode when using these attachments. Although it is possible to select this mode on the camera, the PhotoStitch software will not be able to stitch the images together at the computer.
- Completely remove all dust and dirt from conversion lenses with a lens blower brush before use. The camera may focus on any dirt that remains.
- Be careful when handling the lenses so as not to get fingerprints on them.



To turn off the power for a short time such as between shooting sessions, leave the conversion lens attached and lightly press the lens cover. If you will not be using the camera for a long time, remove the conversion lens and close the lens cover.

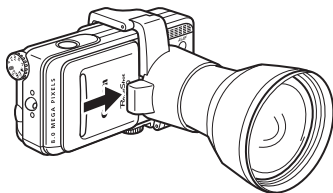

Using an Externally Mounted Flash (Sold Separately)

High-Power Flash HF-DC1

This flash is used to supplement the camera's built-in flash when the subject is too far away for proper illumination. Use the following procedures to affix the camera and High-Power Flash to the supporting bracket.

Please read the instructions accompanying the flash along with this explanation.

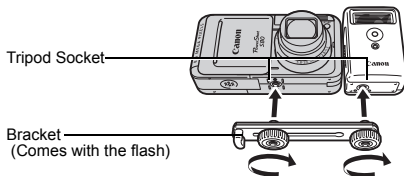

- When in **M** shooting mode the high-power flash will not fire.
- The flash charge time will lengthen as the battery charge gets weaker. Always set the power/mode switch to [OFF] when you finish using the flash.
- Be careful not to touch the flash window or sensor windows with your fingers while the flash is in use.
- In outdoor settings in the daylight, the flash may not detect illumination from the camera's built-in flash and may not fire.
- The flash may fire if another flash is being used in close proximity.
- The flash may not fire if there are no reflective items in its metering field.
- For continuous shooting, although the flash fires for the first shot, it does not fire for subsequent shots.
- If the battery usage time has considerably diminished, wipe the battery terminals well with a dry cloth as the terminals may be soiled with oil from one's skin or other dirt.
- If the battery is used in cold regions (0 °C /32 °F or lower), you are recommended to carry a spare lithium battery (CR123A or DL123). Keep the spare battery warm in your pocket until immediately before using it, and exchange it frequently with the battery in the flash.
- Leaving it in the flash could lead to the battery leaking and damaging the flash. Remove the battery from the flash and store it in a dry and cool location if you will not use it for extended periods.
- Fasten the attachment screws securely so that they do not loosen. Failure to do so may lead to the dropping of the camera and flash resulting in damage to both.



- ◆ Before affixing the bracket to the flash, check that the lithium battery (CR123A or DL123) is installed.
- ◆ To illuminate the subjects properly, install the flash so that it is up against the side of the camera and parallel with the camera's front panel.
- ◆ A tripod can be used even when the flash is attached.

Camera Care and Maintenance

If the camera, lenses, viewfinder or LCD monitor become dirty, use the following cleaning methods.



Never use thinners, benzene, synthetic cleansers or water to clean the camera. These substances may distort or damage the equipment.

Camera Body : Gently wipe dirt off the camera body with a soft cloth or eyeglass lens wiper.

Lens : First use a lens blower brush to remove dust and dirt, then remove any remaining dirt by wiping the lens lightly with a soft cloth.



Never use synthetic cleansers on the camera body or lens. If dirt remains, contact the closest Canon Customer Support Help Desk as listed on the separate Canon Customer Support leaflet.

Viewfinder : Use a lens blower brush to remove dust and dirt. If necessary, gently wipe with a soft cloth or an eyeglass lens wiper to remove stubborn dirt.



Never rub or press strongly on the LCD monitor. These actions may damage it or lead to other problems.

Specifications

All data is based on Canon's standard testing methods. Subject to change without notice.

PowerShot S80

Camera Effective Pixels	: Approx. 8 million
Image Sensor	: 1/1.8 -inch type CCD (Total number of pixels: Approx 8.3 million)
Lens	: 5.8 (W) - 20.7 (T) mm (35mm film equivalent: 28 - 100 mm) f/2.8 (W) - f/5.3 (T)
Digital Zoom	: Approx. 4.0x (Up to approx. 14x in combination with the optical zoom)
Optical Viewfinder	: Real-image zoom viewfinder, picture coverage approx. 80%
LCD Monitor	: 2.5 inch type, low-temperature polycrystalline silicon TFT color LCD (115,000 pixels, picture coverage 100%)
AF System	: TTL autofocus Focus lock and Manual focus are available 9-point (AiAF)/1-point (AF) 1-point AF: 1-point/frame can be moved manually
Shooting Distance (from front of lens)	: Normal: 44 cm (1.4 ft.) - infinity (W/T) Macro: 4 cm - 44 cm (1.6 in. - 1.4 ft.) (W)/30 cm - 44 cm (1.0 ft. - 1.4 ft.) (T) Manual focus: 4 cm (1.6 in.) - infinity (W)/30 cm (11.8 in.) - infinity (T)
Shutter	: Mechanical shutter + electronic shutter
Shutter Speeds	: 15 - 1/2000 sec. <ul style="list-style-type: none">• The shutter speed range varies according to the shooting mode.• Slow shutter speeds of 1.3 sec. or slower operate with noise reduction.
Metering System	: Evaluative, Center-weighted average or Spot (Center* or AF-point)
Exposure Compensation	: 2 stops in 1/3-stop increments Auto exposure bracketing (AEB) and Safety Shift is available.
ISO Speed	: Auto*, ISO 50/100/200/400 equivalent * Camera automatically sets the optimal speed.
White Balance	: Auto, pre-set (available settings: Day Light, Cloudy, Tungsten, Fluorescent, Fluorescent H, Flash or Underwater) or custom
Built-in Flash	: Auto*, on*, off, FE lock, Slow synchro and 1st-curtain/2nd-curtain flash are available. * Red-eye reduction is available.

(W): Max. wide angle (T): Max. telephoto

Flash Range (Built-in)	: 55 cm to 4.2 m (1.8 ft. to 13.8 ft.) (W), 55 cm to 2.0 m (1.8 ft. to 6.6 ft.) (T)(When speed is set to ISO AUTO.)
Flash Exposure Compensation	: 2 stops in 1/3-stop increments.
Shooting Modes	: Auto Creative zone: Program, Shutter-speed priority, Aperture priority, Manual, Custom Image zone: Special Scene, *1 My Colors, Stitch Assist, Movie*2 *1 Portrait, Landscape, Night scene, Night Snapshot, Kids & Pets, Indoor, Foliage, Snow, Beach, Fireworks, Underwater, Digital Macro *2 Standard, High Resolution, Compact, My Colors
Continuous shooting	: Approx. 1.8 shots/sec. (Large/Fine mode with LCD monitor off)
Intervalometer	: Shooting interval: approx. 1 - 60 min. (1-min. increments) Number of shots: 2 - 100 shots (Maximum number of shots varies according to memory card capacity.)
Self-timer	: Activates shutter after an approx. 10-sec./approx. 2- sec. delay, Custom Timer
PC-controlled Shooting	: Available (USB connection only. Exclusive software program is included in the camera kit.)
Recording Media	: SD Memory Card, MultiMediaCard
File Format	: Design rule for camera file system and DPOF compliant
Data Type	: Still images: Exif 2.2 (JPEG) ^{*1} Movie: AVI (Image data: Motion JPEG; Audio data: WAVE (monaural))
Compression	: Superfine, Fine, Normal
Number of recording pixels (Still images)	: Large: 3264 x 2448 pixels Medium 1: 2592 x 1944 pixels Medium 2: 2048 x 1536 pixels Medium 3: 1600 x 1200 pixels Small: 640 x 480 pixels
Number of recording pixels/ Frame Rate (Movies)	: 1024 x 768 pixels (15 frames/sec.) 640 x 480 pixels (30 frames/sec.) 640 x 480 pixels (15 frames/sec.) 320 x 240 pixels (30 frames/sec.) 320 x 240 pixels (15 frames/sec.) 160 x 120 pixels (15 frames/sec.) Continuous until memory card is full (up to 3 mins. at 160 x 120 pixels 15 frames/sec.) (Maximum Size: 1 GB/movie)

(W): Max. wide angle (T): Max. telephoto

Playback Modes	: Single (histogram displayable, effect possible), Index (9 thumbnail images), scrolling display Triple Image Scrolling Display Magnified (approx. 10x max. in LCD monitor, forward or reverse selection through magnified images possible), Image search (Jumps over 10 or 100 images, to a movie folders, or to the next shooting date, or nine images at a time during Index playback) Slide Show (effect possible) Sound memos (recording/playback up to 60 sec.) Movie (slow-motion playback possible)
Direct Print	: <i>PictBridge</i> compliant, and <i>Canon Direct Print</i> and <i>Bubble Jet Direct</i> compatible
Display Languages	: Languages available for menus and messages (English, German, French, Dutch, Danish, Finnish, Italian, Norwegian, Swedish, Spanish, Simplified Chinese, Russian, Portuguese, Greek, Polish, Czech, Hungarian, Turkish, Traditional Chinese, Korean, Thai and Japanese)
My Camera Settings	: The start-up image, start-up sound, operation sound, self-timer sound, and shutter sound can be customized using the following methods: 1. Using the images and sounds recorded on a camera. 2. Using downloaded data from your computer using the supplied software.
Interface	: USB 2.0 Hi-Speed (mini-B), PTP (Picture Transfer Protocol) Audio/Video output (NTSC or PAL selectable)
Power Source	: 1. Rechargeable Lithium-ion battery NB-2LH (included in the camera kit)/NB-2L (sold separately) 2. AC Adapter Kit ACK-DC20 (sold separately) 3. Car Battery Charger Kit CBC-NB2 (sold separately)
Operating Temperatures	: 0 - 40 °C (32 - 104 °F)
Operating Humidity	: 10 - 90 %
Dimensions	: 104.0 x 57.0 x 38.8 mm (4.1 x 2.2 x 1.5 in.) (excluding protrusions)
Weight	: Approx. 225 g (7.9 oz.) (camera body only)

*1 This digital camera supports Exif 2.2 (also called "Exif Print"). Exif Print is a standard for enhancing the communication between digital cameras and printers. By connecting to an Exif Print-compliant printer, the camera's image data at the time of shooting is used and optimized, yielding extremely high quality prints.

Battery Performance

	Number of Images Shot		Playback Time
	LCD Monitor ON (Based on the CIPA standard)	LCD Monitor Off	
Battery Pack NB-2LH (Fully charged)	Approx. 200 images	Approx. 700 images	Approx. 5 hours

- The actual figures will vary according to the shooting conditions and settings.
- Movie data is excluded.
- At low temperatures, battery performance may diminish and the low battery icon appears very rapidly. In these circumstances, the performance can be improved by warming the batteries in a pocket before use.

<Test Conditions>

Shooting: Normal temperature ($23\text{ }^{\circ}\text{C} \pm 2\text{ }^{\circ}\text{C}/73\text{ }^{\circ}\text{F} \pm 3.6\text{ }^{\circ}\text{F}$), normal relative humidity ($50\% \pm 20\%$), alternating wide angle max. and telephoto max. shots at 30 second intervals with the flash fired once every two shots and the camera power turned off after every tenth shot. Power is left off for a sufficient amount of time*, then the power is turned back on and the testing procedure is repeated.

- A Canon-brand memory card is used.

* Until the battery returns to normal temperature

Playback: Normal temperature ($23\text{ }^{\circ}\text{C} \pm 2\text{ }^{\circ}\text{C}/73\text{ }^{\circ}\text{F} \pm 3.6\text{ }^{\circ}\text{F}$), normal relative humidity ($50\% \pm 20\%$), continuous playback at 3 seconds per image.

































Battery Handling (p. 125)

Memory Cards and Estimated Capacities (Recordable Images)

Still images

: Card included with the camera













			SDC-32M	SDC-128M	SDC-512MSH
L 3264 x 2448 pixels			8	35	139*
			13	59	231
			29	123	479
M1 2592 x 1944 pixels			11	49	190
			20	87	339
			40	173	671
M2 2048 x 1536 pixels			17*	76	295
			32	136	529
			63	269	1041
M3 1600 x 1200 pixels			28	121	471
			51	217	839
			97	411	1590
S 640 x 480 pixels			109	460	1777
			168	711	2747
			265	1118	4317

 Capable of smooth continuous shooting (p. 40). This reflects standard shooting criteria established by Canon. Actual results may vary according to the subject and shooting conditions.

* Smooth continuous shooting only available when card has been formatted with a low level format.

Movies

: Card included with the camera

			SDC-32M	SDC-128M	SDC-512MSH
1024 x 768 pixels	15 frames/sec.	 	14 sec.	1 min. 4 sec.	4 min. 9 sec.
640 x 480 pixels	30 frames/sec.	 	14 sec.	1 min. 4 sec.	4 min. 9 sec.
640 x 480 pixels	15 frames/sec.	 	30 sec.	2 min. 7 sec.	8 min. 14 sec.
320 x 240 pixels	30 frames/sec.	 	42 sec.	3 min. 1 sec.	11 min. 42 sec.
320 x 240 pixels	15 frames/sec.	 	1 min. 24 sec.	5 min. 55 sec.	22 min. 53 sec.
160 x 120 pixels	15 frames/sec.	 	3 min. 26 sec.	14 min. 29 sec.	55 min. 57 sec.







- These figures reflect standard shooting conditions established by Canon. Actual totals may vary according to the subject, shooting conditions and shooting mode.
- **L**, **M1**, **M2**, **M3** and **S** indicate recording pixels.
-  (Superfine),  (Fine) and  (Normal) indicate the compression setting.

Image File Sizes (Estimated)

Still images

Resolution		Compression		
				
L	3264 x 2448 pixels	3436 KB	2060 KB	980 KB
M1	2592 x 1944 pixels	2503 KB	1395 KB	695 KB
M2	2048 x 1536 pixels	1602 KB	893 KB	445 KB
M3	1600 x 1200 pixels	1002 KB	558 KB	278 KB
S	640 x 480 pixels	249 KB	150 KB	84 KB

Movies

Resolution	Frame Rate	
	30 frames/sec.	15 frames/sec.
1024 x 768 pixels	-	1980 KB/sec.
640 x 480 pixels	1980 KB/sec.	990 KB/sec.
320 x 240 pixels	660 KB/sec.	330 KB/sec.
160 x 120 pixels	-	120 KB/sec.

SD Memory Card

Interface : Compatible with SD memory card standards

Dimensions : 32.0 x 24.0 x 2.1 mm (1.3 x 0.9 x 0.1 in.)

Weight : Approx. 2 g (0.1 oz.)

Battery Pack NB-2LH

Type : Rechargeable lithium ion battery

Nominal voltage : DC 7.4 V

Nominal amperage	: 720 mAh
Charge cycles	: Approx. 300
Operating temperatures	: 0 - 40 °C (32 - 104 °F)
Dimensions	: 33.3 x 45.2 x 16.2 mm (1.3 x 1.8 x 0.6 in.)
Weight	: Approx. 43 g (1.5 oz.)

Battery Charger CB-2LW/CB-2LWE

Input voltage	: AC 100 - 240 V (50/60 Hz) 0.12 A (100 V) - 0.065 A (240 V)
Rated output	: 8.4 V DC, 0.55 A
Charging time	: Approx. 90 minutes
Operating temperatures	: 0 - 40 °C (32 - 104 °F)
Dimensions	: 91.0 x 22.5 x 56.0 mm (3.6 x 0.9 x 2.2 in.)
Weight	: CB-2LW: Approx. 68 g (2.4 oz.) CB-2LWE: Approx. 61 g (2.2 oz.)

Compact Power Adapter CA-PS700

(Included with the separately sold AC Adapter Kit ACK-DC20)

Input voltage	: 100 - 240 V AC (50/60 Hz) 30 VA (100 V) - 40 VA (240 V)
Rated output	: 7.4 V DC/2.0 A
Operating Temperatures	: 0 - 40 °C (32 - 104 °F)
Dimensions	: 112 x 29 x 45 mm (4.4 x 1.1 x 1.8 in.) (body only)
Weight	: Approx. 186 g (6.6 oz.) (excluding power cord)

Car Battery Charger CBC-NB2 (sold separately)

Rated Input	: 12 V/ 24 V DC
Rated Output	: 8.4 V DC/ 0.55 A
Operating temperatures	: 0 - 40 °C (32 - 104 °F)
Dimensions	: 91.0 x 56.0 x 29.5 mm (3.6 x 2.2 x 1.2 in.)
Weight	: Approx. 145 g (5.1 oz.)

Wide Converter WC-DC10 (Sold Separately)

Magnification	: Approx. 0.8
Focal Length	: 22.4 mm (35mm film equivalent)
Lens composition	: 2 elements in 2 groups
Shooting Distance (from front of lens)	: 27 cm - infinity (10.6 in. - infinity)
Thread Diameter	: 37 mm standard filter thread (Conversion Lens Adapter LA-DC20 is required for mounting to PowerShot S80)
Dimensions	: Diameter: 63.5 mm (2.5 in.) Length: 24.5 mm (1.0 in.)
Weight	: Approx. 95 g (3.4 oz.)

Tele-converter TC-DC10 (sold separately)

Magnification	: Approx. 2.0
Focal length (Maximum telephoto)	: 200 mm (35mm film equivalent)
Lens composition	: 4 elements in 3 groups
Shooting distance (from front of lens)	: 1.2 m - infinity (3.9 ft. - infinity)
Thread diameter	: 37 mm standard filter thread (Conversion Lens Adapter LA-DC20 is required for mounting to PowerShot S80)
Dimensions	: Diameter: 63.5 mm (2.5 in.) : Length: 54.5 mm (2.1 in.)
Weight	: Approx. 145 g (5.1 oz.)

Conversion Lens Adapter LA-DC20 (sold separately)

Thread Diameter	: 37 mm standard filter thread
Dimensions	: Attached: 62.2 x 70.6 x 73.9 mm (2.4 x 2.8 x 2.9 in.) : Stored: 62.2 x 76.4 x 44.6 mm (2.4 x 3.0 x 1.8 in.)
Weight	: Approx. 28 g (1.0 oz.)

Photo Tips and Information

Regarding the AF Frame (p. 60)

AiAF* has a wide range of measuring for accurate focusing. AiAF focuses on the object even if it is not exactly in the center of the frame.

* "Ai" stands for "Artificial intelligence" and "AF" stands for "Auto Focus."

Advanced Techniques for the Macro Mode (Basic)

Macro mode can make unique images when used with the zoom function. For example, shooting a flower at maximum wide angle in Macro mode allows the camera to bring both the flower and the background into focus. However, shooting at maximum telephoto can throw the background out of focus to make the flower stand out.



Macro with the wide angle zoom



Macro with the telephoto zoom

Tip for Using the Self-timer (p. 36)

Normally, the camera shakes a little when you press the shutter button. Setting the self-timer to  delays the shutter release for 2 seconds and allows the camera to stop shaking, thus preventing a blurred image. Even better results can be obtained by placing the camera on a stable surface or by using a tripod to shoot.

Exposure Compensation (p. 69)

This camera automatically adjusts the exposure to shoot images with the optimal brightness. However, recorded images may sometimes be brighter or darker than the actual image depending on the shooting conditions. If this happens, adjust the exposure compensation manually.

●Underexposure

The whole recorded image is dark, which makes white elements of the image appear gray. Shooting bright subjects or in backlit conditions may cause the image to be underexposed. Adjust the exposure compensation towards the (+) end.



●Optimal Exposure



●Overexposure

The whole recorded image is bright, which makes black elements of the image appear gray. Shooting dark subjects or in dark places may cause the image to be overexposed. Adjust the exposure compensation towards the (-) end.



ISO Speed (p. 74)

The ISO speed is the numeric representation of the camera's sensitivity to light. The higher the ISO speed, the higher the sensitivity. A high ISO speed allows you to shoot images in dark indoor or outdoor conditions without a flash and also helps prevent blurred images due to camera shake. This is convenient when shooting images in places where flash photography is prohibited. The ISO speed setting makes full use of the available light, resulting in images that convey the feel of the place they were shot.



ISO 50 equivalent



ISO 400 equivalent

INDEX

A

AC Adapter Kit	128
AE Lock	65
AEB Mode	75
AF frame (☒)	66
AF Lock	63
AF-assist Beam	10, 11, 27
AiAF	60
Aperture value	51
Aperture-priority	
AE mode (Av)	51
Auto Power Down	21, 30
Auto Rotate	30, 83
Automated Playback	99

B

Battery	
Performance	139
Status	125
B/W	72

C

Camera Care and Maintenance	135
Car Battery Charger	129
Color Accent Mode	55
Color Swap Mode	56
Compact Power Adapter	128
Compression	33
Continuous Shooting (☑)	40
Contrast	73
Conversion Lenses	131
Creative Zone	48
Custom (C)	82
Custom Color Mode	58

D

Date/Time	30
DCF	19, 137
Detailed Display	15
Digital Zoom	27, 39
Display Off	22, 30
DISP.	12, 15
DPOF	
Print Order	28, 107

Transfer Order	28, 110
----------------	---------

E

Effects	93
Erase all	28
Erasing (☒)	
Erase all	28
Erasing All Images	105
Erasing Single Images	
<i>Basic Guide: p. 14</i>	
Exposure (☒)	69, 145

F

FE Lock	67
File Number	84
File Numbering	30, 84
Flash (⚡)	10
Flash Adjust	77
Flash Sync	27, 79
Focus	62
Focus Lock	62
Focus-BKT Mode	76
Folder	86
Format	30
Formatting	23
Functions Available in	
Each Shooting Mode	160
FUNC. Menu	26
FUNC./SET	12

G

Grid Lines	17, 27
------------	--------

H

High-Power Flash	134
Histogram	17, 19, 20

I

Index Playback (☒)	88
Indicator	13
Information View	15
Initializes	30
Intervalometer	28, 80
ISO speed	74
Item	27

J	
Jumping (⏮)	90
L	
Language	31
LCD Brightness	29
LCD Monitor	12
List of Messages	122
M	
Macro (👉) <i>Basic Guide</i> : p. 13	
Magnifying Images (Q)	88
Manual aperture	52
Manual Focus Mode (MF)	64
Memory Card	
Format	23
Memory card	
Recordable Images	140
MENU	12
Menu	
FUNC. Menu	26
Play Menu	28
Rec. Menu	27
Set up Menu	29
Metering Method	68
MF	64
MF-Point Zoom	27, 64
Mode Dial	13
Movie	
Editing	94
Shooting	41
Viewing	94
Movie modes	41
Multi control dial	14
My Camera content	113, 114
My Camera Menu	31
My Camera Settings	113
My Colors Mode	53
N	
Night Display	16
O	
Operation Sound	29, 31, 114, 115
Overexposure Warning	20
P	
Panoramic Images	45
Photo Effect	72
Play Menu	28
Playback Mode (▶)	
. <i>Basic Guide</i> : p. 15	
Playback Vol.	29
Playing Review	
Viewing Images on a	
TV Set	112
Power Saving	21, 30
Power/Mode Indicator	13
Printing	106
Print Order	107
Print/Share (🖨️)	12
Program AE	50
Protect	28, 104
Q	
Quick-bright LCD Function	16
R	
Rec. Menu	27
Red-Eye Reduction	35
Resolution	33
Review	28
Rotate	28, 92
S	
Saturation	73
Saving Custom Settings	82
Scroll playback	91
SD card	127
Self-timer (⏱)	27, 36
Self-timer Sound	
.	29, 31, 114, 115
Set up Menu	29
Sharpness	73
Shooting Mode <i>Basic Guide</i> : p. 8	
Shooting Close-Ups	
. <i>Basic Guide</i> : p. 13	
Shortcut	28, 59
Shortcut Button (⏮)	59

Shutter Button	12
Shutter Sound	31, 114, 115
Shutter sound	29
Shutter speed	50
Shutter speed-priority	
AE mode (Tv)	50
Slide Show	28, 99
Slide Shows	99
Effects	103
Play Time	102
Repeat	102
Select images	100
Set up	101
Start	100
Slow Synchro	27, 35
Smooth continuous shooting	40
Sound Memos (🎤)	97
Speaker	12
Spot AE Point	27, 68
Standard Display	15
Start-up Image	31, 114, 115
Start-up Sound	31, 114, 115
Start-up sound	29
Stitch Assist	45

T

Tele-converter	131
Telephoto (📷)	12
Terminal Cover	12
Time Zone	24, 30
Transfer Order	110
Selecting Images	110

V

Video System	31
Viewfinder	12, 14
Volume	29

W

White Balance	70
Wide Angle (📷)	12
Wideconverter	131

Z

Zoom	12, 39, 88
------	------------

Numerics

1st-curtain	79
2nd-curtain	79

MEMO

MEMO

MEMO

MEMO

MEMO

MEMO

MEMO

MEMO

MEMO

Disclaimer

- While every effort has been made to ensure that the information contained in this guide is accurate and complete, no liability can be accepted for any errors or omissions.
- Canon reserves the right to change the specifications of the hardware and software described herein at anytime without prior notice.
- No part of this guide may be reproduced, transmitted, transcribed, stored in a retrieval system, or translated into any language in any form, by any means, without the prior written permission of Canon.
- Canon makes no warranties for damages resulting from corrupted or lost data due to a mistaken operation or malfunction of the camera, the software, memory cards, personal computers, peripheral devices, or use of non-Canon memory cards.

Trademark Acknowledgments

- Canon, PowerShot, PIXMA and SELPHY are trademarks of Canon Inc.
- Macintosh, Mac OS and QuickTime are trademarks of Apple Computer Inc., registered in the United States and/or other countries.
- Microsoft® and Windows® are either registered trademarks or trademarks of Microsoft Corporation in the United States and/or other countries.
- SD is a trademark.
- Other names and products not mentioned above may be registered trademarks or trademarks of their respective companies.

FCC Notice

(Digital Camera, Model PC1155)

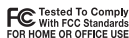

This device complies with Part 15 of the FCC Rules. Operation is subject to the following two conditions;

- (1) this device may not cause harmful interference, and
- (2) this device must accept any interference received, including interference that may cause undesired operation.

Note: This equipment has been tested and found to comply with the limits for Class B digital devices, pursuant to Part 15 of the FCC rules. These limits are designed to provide reasonable protection against harmful interference in a residential installation. This equipment generates, uses and can radiate radio frequency energy and, if not installed and used in accordance with the instructions, may cause harmful interference to radio communications. However, there is no guarantee that interference will not occur in a particular installation. If this equipment does cause harmful interference to radio or television reception, which can be determined by turning the equipment off and on, the user is encouraged to try to correct the interference by one or more of the following measures:

- Reorient or relocate the receiving antenna.
- Increase the separation between the equipment and receiver.
- Connect the equipment into an outlet on a circuit different from that to which the receiver is connected.
- Consult the dealer or an experienced radio/TV technician for help.

The cable with the ferrite core provided with the digital camera must be used with this equipment in order to comply with Class B limits in Subpart B of Part 15 of the FCC rules.

Do not make any changes or modifications to the equipment unless otherwise specified in the manual. If such changes or modifications should be made, you could be required to stop operation of the equipment.

Canon U.S.A. Inc.
One Canon Plaza, Lake Success, NY 11042, U.S.A.
Tel No. (516) 328-5600

Canadian Radio Interference Regulations

This Class B digital apparatus complies with Canadian ICES-003.

Réglementation canadienne sur les interférences radio

Cet appareil numérique de la classe B est conforme à la norme NMB-003 du Canada.

Functions Available in Each Shooting Mode

This chart shows the functions available in each shooting mode.
You can shoot with the settings saved in the mode **C** (p. 82)

			AUTO	SCN				P	Tv	Av	M
Resolution (Still images) p. 33	Large	L	○*	○*	○*	△*	—	○*	○*	○*	○*
	Medium 1	M1	○	○	○	△	—	○	○	○	○
	Medium 2	M2	○	○	○	△	—	○	○	○	○
	Medium 3	M3	○	○	○	△	—	○	○	○	○
Compression p. 33	Small	S	○	○	○	△	—	○	○	○	○
	Superfine		○	○	○	△	—	○	○	○	○
	Fine		○*	○*	○*	△*	—	○*	○*	○*	○*
Resolution/ Frame rate (Movies) p. 33	Normal		○	○	○	△	—	○	○	○	○
	1024 x 768 pixels 15 frames/sec.		—	—	—	—	○	—	—	—	—
	640 x 480 pixels 30 frames/sec.		—	—	—	—	○*	—	—	—	—
	640 x 480 pixels 15 frames/sec.		—	—	—	—	○	—	—	—	—
	320 x 240 pixels 30 frames/sec.		—	—	—	—	○	—	—	—	—
	320 x 240 pixels 15 frames/sec.		—	—	—	—	○	—	—	—	—
Flash <i>Basic Guide:</i> p. 13	Auto		○*	○ ^(1/2)	○* ⁽³⁾	—	—	○	—	—	—
	On		—	○ ^(1/2)	○	△	—	○	○	○	○
	Off		○	○ ⁽⁴⁾	○	△*	—	○*	○*	○*	○*
Red-eye reduction p. 34		○	○ ^(1/4)	○	△	—	○	○	○	○	
Slow Synchro p. 35	On	—	○ ⁽⁵⁾	○	△	—	○	—	○	—	
	Off	○	○	○*	△*	—	○*	○	○*	○	
Flash Adjust p. 77	On	○	○ ⁽²⁾	○	△	—	○	○*	○*	—	
	Off	—	—	—	—	—	—	○	○	○	
Flash firing p. 79	1st-curtain	○	○ ⁽²⁾	○*	○	—	○*	○*	○*	○*	
	2nd-curtain	—	—	○	—	—	○	○	○	○	
Drive Mode p. 40, 36	Single	□	○*	○*	○*	○*	○*	○*	○*	○*	
	Standard Continuous Mode p. 40		—	○	—	—	—	○	○	○	
	10-sec. selftimer p. 36		○*	○*	○*	△*	○*	○*	○*	○*	
	2-sec. selftimer		○	○	○	△	○	○	○	○	
Intervalometer p. 80	Custom Timer		○	○	—	—	○	○	○	○	
AF Frame p. 60	Intervalometer p. 80		—	—	—	—	—	○	○	○	
	AiAF	○*	○* ⁽⁶⁾	○*	○	○	○	○	○	○	
	1-Point	○	○	○	—	—	○*	○*	○*	○*	
Manual Focus p. 64	Manual	—	—	—	—	—	○	○	○	○	
		—	○ ⁽¹⁾	○	○	○	○	○	○	○	

			SCN				P	Tv	Av	M
MF-Point Zoom p. 64		–	○ ⁽¹⁾	○	–	–	○	○	○	○
AF-assist Beam p. 27		○	○ ⁽¹⁾	○	△	○	○	○	○	○
Macro		○	○ ⁽⁷⁾	○	△	○	○	○	○	○
	On	○	○	–	–	○ ⁽⁸⁾	○	○	○	○
Digital Zoom p. 39	Off	○*	○* ⁽⁴⁾	○	△	○	○*	○*	○*	○*
	Safety Shift p. 52	–	–	–	–	–	–	○	○	–
Exposure Compensation p. 69			–	○	○	△	–	○	○	–
Exposure Shift p. 43		–	–	–	–	○ ⁽⁹⁾	–	–	–	–
Metering Method p. 68	Evaluative		○	○	○*	○	○	○*	○*	○*
	Center-Weighted Average Metering		–	–	○	–	–	○	○	○
	Spot		–	–	○	–	–	○	○	○
	Center		–	–	○	–	–	○*	○*	○*
	AF Point		–	–	○	–	–	○	○	○
AE Lock/FE Lock p. 65, 67			–	–	○	–	○ ⁽¹⁰⁾	○	○	○
Bracket	AEB p. 75		–	–	–	–	○	○	○	–
	Focus-BKT p. 76		–	–	–	–	○ ⁽¹¹⁾	○ ⁽¹¹⁾	○ ⁽¹¹⁾	○ ⁽¹¹⁾
White Balance ⁽¹²⁾ p. 70		WB	_(⁽¹³⁾)	_(⁽¹³⁾)	○	△	○ ⁽¹⁴⁾	○	○	○
Photo Effect p. 72		–	–	–	△	○ ⁽¹⁵⁾	○	○	○	○
	Contrast/Sharpness/Saturation		–	–	–	–	○	○	○	○
ISO Speed p. 74			_(⁽¹⁶⁾)	_(⁽¹⁶⁾)	_(⁽¹⁶⁾)	_(⁽¹⁶⁾)	_(⁽¹⁶⁾)	○	○	○
Save Original p. 54		–	–	○	–	–	–	–	–	–
Grid Lines p. 28		○	○	○	–	○	○	○	○	○
Histogram p. 20		–	–	–	–	–	○	○	○	○
Auto Rotate p. 83	On	○*	○*	○*	△*	–	○*	○*	○*	○*
	Off	○	○	○	△	○	○	○	○	○

*: Default setting ○: Setting available △: Setting can only be selected for the first image.
–: Setting selection is not possible.

- : Setting remains in effect even when the camera is turned off.
- The default for the settings changed by the menu and button operations can be restored all at once except for [Date/Time], [Language], [Video System] and [Time Zone] (p. 30)

- (1) Fireworks mode cannot be set.
- (2) Digital Macro cannot be set.
- (3) In Color Accent and Color Swap, the flash is deactivated by default.
- (4) Landscape, Foliage, Fireworks and Digital Macro are default settings.
- (5) [On] only in Landscape, Night Scene and Night Snapshot mode ([Off] cannot be set).
- (6) Fireworks, Kids and Pets mode cannot be set.
- (7) Landscape, Fireworks, Kids & Pets and Digital Macro mode cannot be set.
- (8) Standard mode only is available.
- (9) Can be set after AE lock is set.
- (10) AE lock only is available.
- (11) Selectable only in manual focus.
- (12) Cannot be adjusted when the photo effect is set to [Sepia] or [B/W].
- (13) The white balance is set to [AUTO].
- (14) The white balance [Flash] cannot be set.
- (15) Mycolors mode cannot be set.
- (16) Automatically set by the camera.
- (17) ISO [AUTO] cannot be set.