

ENGLISH



Canon DIGITAL CAMERA PowerShot G9 Camera User Guide

# Canon PowerShot G9 Camera User Guide



Getting Started

Learning More

- Components Guide
- Basic Operations
- Commonly Used Shooting Functions
- Shooting Using the Mode Dial
- Advanced Shooting Functions
- Playback/Erasing
- Print Settings/Transfer Settings
- Connecting a TV set
- Customizing the Camera
- Troubleshooting
- List of Messages
- Appendix

Ensure that you read the Safety Precautions (pp. 224–229).

# Workflow and Reference Guides

The following guides are available. Refer to them as necessary according to the flowchart below.

 : This Guide

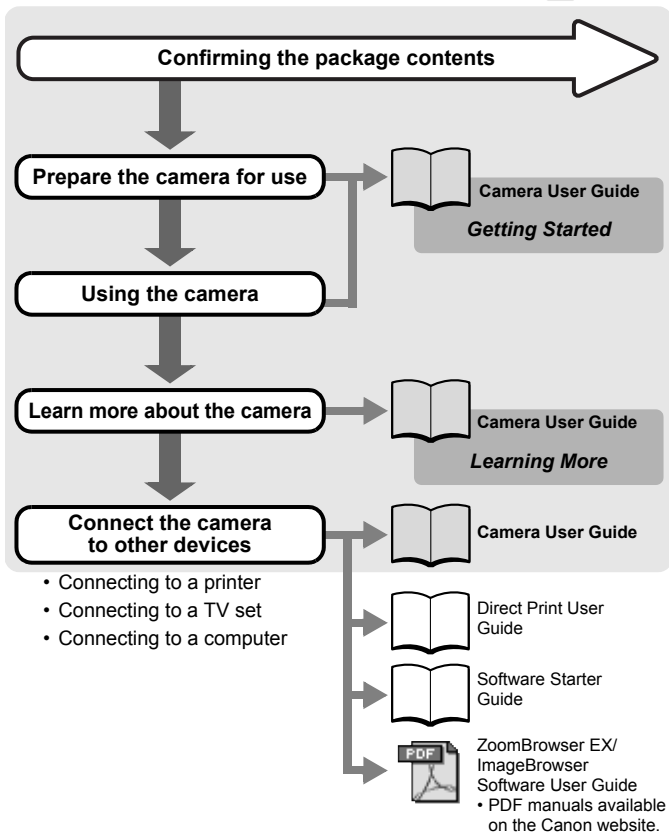

<http://web.canon.jp/Imaging/information-e.html>

## Confirming the Package Contents

Your camera package includes all of the following items. If any of these items are missing, please contact the dealer for assistance.

1



Digital Camera

2



Battery Pack  
NB-2LH  
(With Terminal Cover)

3



Battery Charger  
CB-2LW/CB-2LWE

4



Memory Card  
(32MB)

5

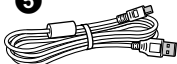

Interface Cable  
IFC-400PCU

6



AV Cable  
AVC-DC300

7



Neck Strap  
NS-DC6

8



Canon Digital Camera  
Solution Disk

9



Warranty Card

### 10 User Guides



- Camera User Guide
- Direct Print User Guide
- Software Starter Guide
- "Canon Customer Support" Leaflet
- "Use of Genuine Canon Accessories Recommended" Leaflet

You may not be able to achieve the full performance of this camera with the included memory card.



You can use SD memory cards, SDHC memory cards, MultiMediaCards, MMCplus cards and HC MMCplus cards with this camera. These cards are collectively called memory cards in this guide.

# Table of Contents

Items marked with a ☆ are lists or charts that summarize camera functions or procedures.









Please Read .....	7
-------------------	---





## Getting Started

Preparations .....	10
Shooting Still Images (📷 Auto Mode) .....	16
Viewing Still Images .....	19
Shooting Movies (🎥 Standard Mode) .....	20
Viewing Movies .....	22
Erasing .....	23
Printing .....	24
Downloading Images to a Computer .....	26
System Map .....	34

## Learning More

<b>Components Guide</b> .....	<b>40</b>
Using the Control Dial .....	43
Indicators .....	44
Power Saving Function .....	45
<b>Basic Operations</b> .....	<b>46</b>
☆ Menus and Settings .....	46
☆ Menus and Default Settings .....	48
Switching between Shooting Mode and Playback Mode ..	54
Using the LCD Monitor .....	55
LCD Monitor Brightness .....	56
Customizing Display Information .....	57
Information Displayed on the LCD Monitor .....	59
Setting the World Clock .....	65
Resetting Settings to Their Default Values .....	68

Formatting Memory Cards . . . . .	69
<b>Commonly Used Shooting Functions</b>	<b>70</b>
<hr/>	
  Using the Optical Zoom . . . . .	70
Using the Digital Zoom/Digital Tele-Converter . . . . .	71
 Using the Flash . . . . .	74
 Shooting Close-ups (Macro) . . . . .	75
 Using the Self-Timer . . . . .	76
Changing the Recording Pixels and Compression (Still Images) . . . . .	78
Changing the Image Type . . . . .	80
Setting the Image Stabilizer Function . . . . .	82
Adjusting the ISO Speed . . . . .	84
Checking the Focus and Peoples' Expressions (Focus Check) . . . . .	86
<b>Shooting Using the Mode Dial</b>	<b>88</b>
<hr/>	
Mode Dial . . . . .	88
Shooting Modes for Specific Scenes . . . . .	89
<b>P</b> Program AE . . . . .	93
<b>Tv</b> Setting the Shutter Speed . . . . .	94
<b>Av</b> Setting the Aperture . . . . .	96
<b>M</b> Manually Setting the Shutter Speed and Aperture . . . . .	98
 Shooting Panoramic Images (Stitch Assist) . . . . .	100
 Movie Shooting . . . . .	102
Setting the Recording Functions . . . . .	108
<b>C</b> Saving Custom Settings . . . . .	109
<b>Advanced Shooting Functions</b>	<b>111</b>
<hr/>	
 Continuous Shooting . . . . .	111
Setting the Red-Eye Reduction Function . . . . .	113
Setting the Slow Synchro . . . . .	114
Switching between Focus Settings . . . . .	115
Selecting an AF Frame Mode . . . . .	116
Shooting Hard-to-Focus Subjects (Focus Lock, AF Lock, Manual Focus, Safety MF) . . . . .	123
Focus Bracketing (Focus-BKT Mode) . . . . .	127

Locking the Exposure Setting (AE Lock) . . . . .	128
Shooting with FE Lock . . . . .	130
Auto Exposure Bracketing (AEB Mode). . . . .	131
Using the ND Filter. . . . .	132
Reducing the Effects of Camera Shake (Auto ISO Shift). . . . .	133
 Adjusting the Exposure Compensation. . . . .	135
Switching between Metering Modes . . . . .	136
Adjusting the Tone (White Balance) . . . . .	137
Shooting in a My Colors Mode. . . . .	140
Changing the Colors and Shooting . . . . .	143
Switching between Flash Adjustment Settings . . . . .	148
Compensating the Flash Adjustment. . . . .	149
Setting the Flash Output . . . . .	150
Switching the Timing at which the Flash Fires. . . . .	151
Adjusting Exposure for Built-in Flash	
Shooting (Safety FE) . . . . .	152
 Registering Settings to the Shortcut Button . . . . .	153
Setting the Auto Rotate Function. . . . .	155
Creating an Image Destination (Folder). . . . .	156
Resetting the File Number . . . . .	158
<b>Playback/Erasing</b>	<b>160</b>
<hr/>	
 Viewing Magnified Images. . . . .	160
 Viewing Images in Sets of Nine (Index Playback) . . . . .	161
Checking the Focus and Peoples' Expressions (Focus Check Display). . . . .	162
 Jumping to Images . . . . .	165
Organizing Images by Category (My Category). . . . .	167
Viewing Movies (Operating the Movie Control Panel) . . . . .	170
Editing Movies . . . . .	172
Rotating Images in the Display . . . . .	174
Playback with Transition Effects . . . . .	175
Automated Playback (Slide Shows). . . . .	176
Red-Eye Correction Function. . . . .	180
Adding My Colors Effects. . . . .	185
Resizing Images . . . . .	187







Attaching Sound Memos to Images . . . . .	189
Sound-Only Recording (Sound Recorder) . . . . .	190
Protecting Images . . . . .	192
Erasing Images . . . . .	195
<b>Print Settings/Transfer Settings</b>	<b>198</b>
Setting the DPOF Print Setting . . . . .	198
Setting the DPOF Transfer Settings . . . . .	203
<b>Connecting a TV set</b>	<b>205</b>
Viewing Images on a TV set . . . . .	205
<b>Customizing the Camera (My Camera Settings)</b>	<b>207</b>
Changing My Camera Settings . . . . .	207
Registering My Camera Settings . . . . .	208
<b>Troubleshooting</b>	<b>210</b>
<b>List of Messages</b>	<b>220</b>
<b>Appendix</b>	<b>224</b>
Safety Precautions . . . . .	224
Preventing Malfunctions . . . . .	229
Battery Handling . . . . .	229
Handling the Memory Card . . . . .	232
Using the Power Kits (Sold Separately) . . . . .	234
Using the Lenses (Sold Separately) . . . . .	236
Using an Externally Mounted Flash (Sold Separately) . . . . .	242
Using an Externally Mounted Flash (Sold Separately) . . . . .	249
Camera Care and Maintenance . . . . .	251
Specifications . . . . .	252
<b>INDEX</b>	<b>264</b>
<b>☆ Functions Available in Each Shooting Mode</b>	<b>270</b>

## Symbol Conventions in this Guide

Advanced Shooting Functions | 131









### Auto Exposure Bracketting (AEB Mode)

 See Functions Available in Each Shooting Mode (p. 286)



Shooting Mode:      



In this mode, the camera automatically changes the exposure within a set range to take three shots as the same interval as continuous shooting (p. 111). The images are shot in the following order: Standard exposure, underexposure and overexposure.

**1 Select AEB.**

1. Press the  button.
2. Use the  or  button to select  and use the  or  button to select .
3. Press the  button.

**2 Adjust the compensation range.**

1. Adjust the compensation range with the  or  button.
2. Press the  button.

Mode: Shooting () / Playback ()

Available shooting modes

 **P Tv Av M**

These modes are available.

These modes are not available.



: This mark denotes issues that may affect the camera's operation.



: This mark denotes additional topics that complement the basic operating procedures.

Explanations in this guide are based on the camera's default settings at time of purchase.



## **Please Read**

### **Test Shots**

Before you try to photograph important subjects, we highly recommend that you shoot several trial images to confirm that the camera is operating and being operated correctly.

Please note that Canon Inc., its subsidiaries and affiliates, and its distributors are not liable for any consequential damages arising from any malfunction of a camera or accessory, including memory cards, that results in the failure of an image to be recorded or to be recorded in a way that is machine readable.

### **Warning Against Copyright Infringement**

Please note that Canon digital cameras are intended for personal use and should never be used in a manner that infringes upon or contravenes international or domestic copyright laws and regulations. Please be advised that in certain cases the copying of images from performances, exhibitions, or commercial properties by means of a camera or other device may contravene copyright or other legal rights even if the image was shot for personal use.

### **Warranty Limitations**

This camera's warranty is only effective in the country of sale. If a problem arises while the camera is in use abroad, please convey it back to the country of sale before proceeding with a warranty claim to a Canon Customer Support Help Desk.

**For Canon Customer Support contacts, please see the customer support list supplied with your camera.**

## **Camera Body Temperature**

---

If your camera is used for prolonged periods, the camera body may become warm. Please be aware of this and take care when operating the camera for an extended period.

## **About the LCD Monitor**

---

The LCD monitor is produced with extremely high-precision manufacturing techniques. More than 99.99% of the pixels operate to specification. Less than 0.01% of the pixels may occasionally misfire or appear as red or black dots. This has no effect on the recorded image and does not constitute a malfunction.

## **Video Format**

Please set the camera's video signal format to the one used in your region before using it with a TV monitor (p. 205).

## **Language Setting**

Please see *Setting the Display Language* (p. 15) to change the language setting.

# Getting Started

- **Preparations**
- **Shooting Still Images**
- **Viewing Still Images**
- **Shooting Movies**
- **Viewing Movies**
- **Erasing**
- **Printing**
- **Downloading Images to a Computer**
- **System Map**

## Preparations

### Charging the Battery

1. Insert the battery into the battery charger.

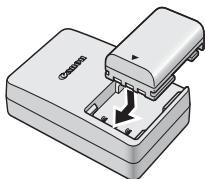

2. Plug the battery charger (CB-2LW) into a power outlet, or attach the power cord to the battery charger (CB-2LWE, not shown) and plug it into a power outlet.

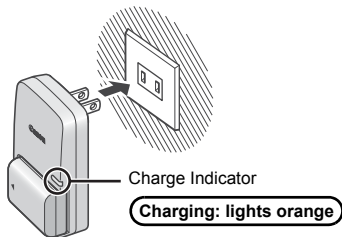

3. Remove the battery after charging is complete.

Charging takes approximately 1 hour 45 minutes.

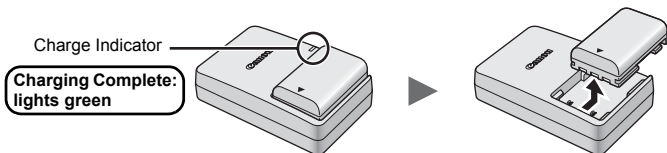

To protect the battery and prolong its life, do not charge it for longer than 24 hours continuously.

## Installing the Battery

1. Slide the cover (①) and open it (②).

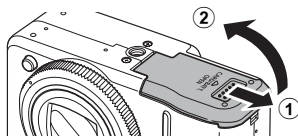

2. Push the battery lock in the direction of the arrow (①) and insert the battery until it locks.

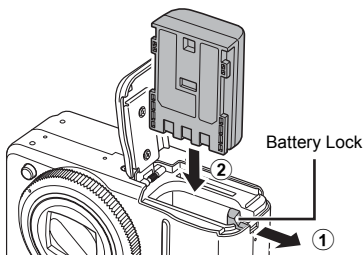

3. Close the cover (①) and slide it until clicks (②).



### ■ To Remove the Battery

Push the battery lock in the direction of the arrow and hold it while pulling the battery out.

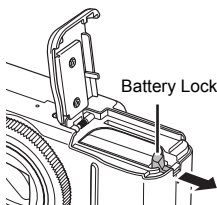

## Inserting the Memory Card

**1.** Slide the cover (①) and open it (②).

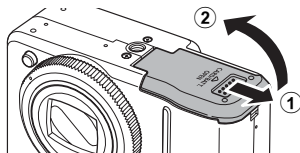

**2.** Insert the memory card until it clicks into place.

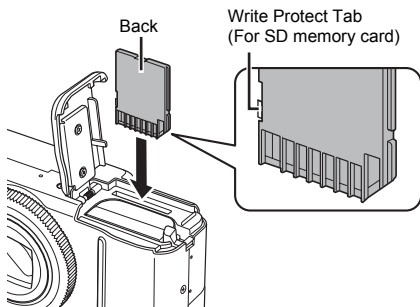

- Confirm that the write protect tab is unlocked (only SD memory cards).
- Check the card for the correct orientation.

**3.** Close the cover (①) and slide it until clicks (②).

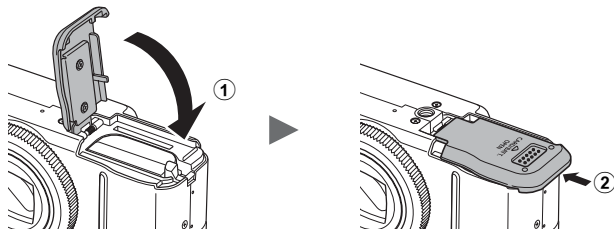

Ensure that the memory card is correctly oriented before inserting it in the camera. Inserting it backward may cause the camera to fail to recognize the memory card or to malfunction.

## ■ To Remove the Memory Card

Push the memory card with your finger until the memory card clicks and then release it.



## ■ Attaching the Neck Strap

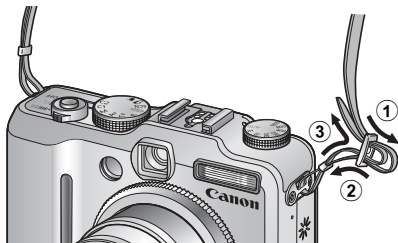

Pull the strap tight in the buckle so that it does not slip. Perform the same steps on the other side of the camera.



In order to avoid dropping the camera, we recommend attaching the neck strap before using the camera.





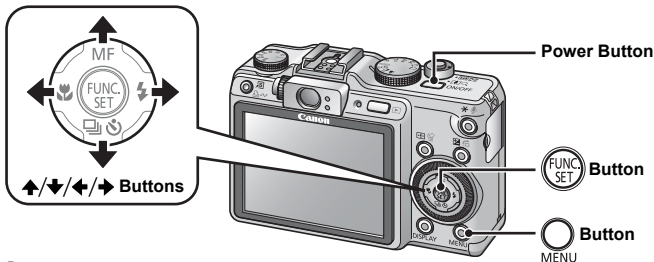

## Setting the Date and Time

The Date/Time settings menu will appear the first time the power is turned on. Set the date and time as shown in Steps 3 and 4 in the explanation below.







**1. Press the power button.**

**2. Select [Date/Time].**

1. Press the  button.
2. Use the  or  button to select the  (Set up) menu.
3. Use the  or  button to select [Date/Time].
4. Press the  button.

**3. Select the year, month, day and time, and the display order.**

1. Use the  or  button to select an option.
2. Use the  or  button to set the value.

**4. Press the  button.**

**5. Press the  button.**

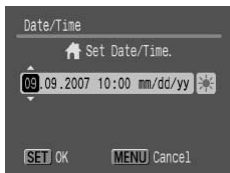
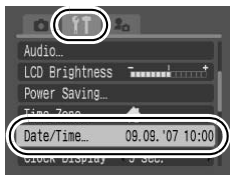











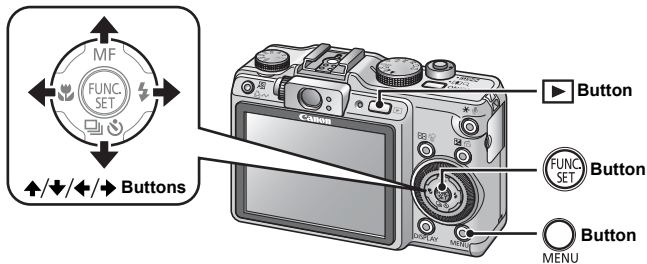

- A rechargeable lithium battery is built into the camera to save such settings as the date/time. This battery charges when the main battery is in the camera. When you purchase the camera, place the main battery in it for approximately four hours or use AC Adapter Kit ACK-DC20 (sold separately) to charge the lithium battery. It will charge even if the camera is turned off.
- The date/time settings may be lost after approximately three weeks if you remove the main battery. Reset the date/time settings if this occurs.

## Setting the Display Language

You can change the language displayed in the LCD monitor menus and messages.



1. Press the  (Playback) button.
2. Hold down the  button and press the  button.
3. Use the , ,  or  button to select a language.
4. Press the  button.

## Shooting Still Images (AUTO Mode)

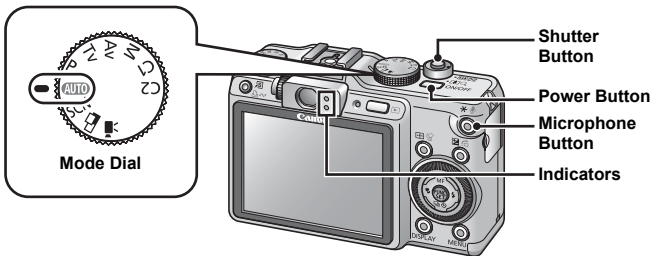

### 1. Press the power button.

- The start-up sound will play and the start-up image will display in the LCD monitor.
- Pressing the power button again turns the power off.

### 2. Select a shooting mode.

1. Set the mode dial to **AUTO**.

### 3. Aim the camera at the subject.



#### 4. Press the shutter button lightly (halfway) to focus.

- When the camera focuses, it beeps twice and the indicator lights green (orange when the flash will fire).



- An AF frame will display in green on the LCD monitor at the point of focus.



AF Frame

#### 5. Press the shutter button fully (all the way) to shoot.

- The shutter sound will play once and the image will record.
- The indicator will blink green and the file will record to the memory card.



### Mute Setting

When you hold down the  (Microphone) button while turning on the camera, the mute setting will be set to [On]. All sounds except for warning sounds will be disabled. You can change the setting in [Mute] in the Set up menu (p. 51).

## Reviewing an Image Right After Shooting (Rec. Review)

Recorded images are displayed on the LCD monitor for approximately 2 seconds immediately after shooting.

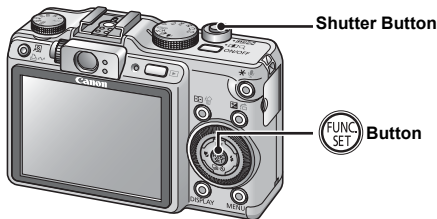

You can also use the following methods to continue displaying the image immediately after shooting so that you can check it.

- **Keep the shutter button pressed fully.**
- **Press the  button while the recorded image is displayed.**

Confirm that the camera beeps.

You can shoot by pressing the shutter button even when an image is being displayed.



You can change the interval for which images are displayed by configuring the [Review] item in the  (Rec.) menu.

## Viewing Still Images

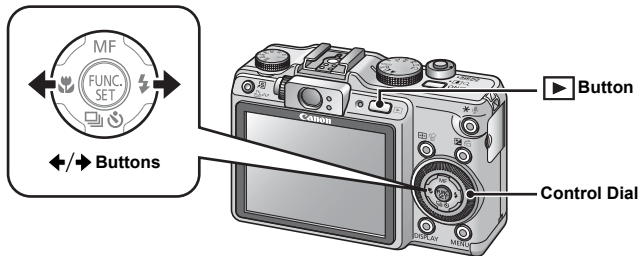

### 1. Press the ▶ (Playback) button.

The last recorded image will display.

### 2. Use the ◀ or ▶ button to display the image you wish to view.

- Use the ◀ button to move to the previous image and the ▶ button to move to the next image.
- The images advance more quickly if you keep the button pressed, but they will appear coarse.
- You can also select images by turning the control dial. Turning it counterclockwise displays the previous image while turning it clockwise displays the next image.



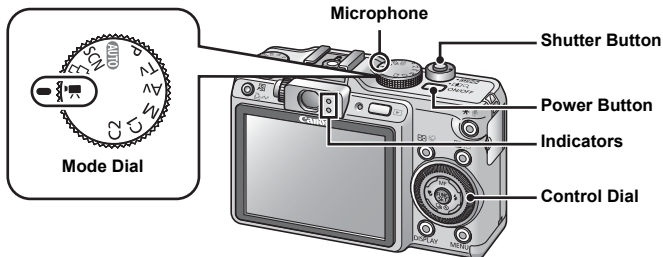

If you have played back images, the last image viewed will display (Resume Playback). If the memory card has been switched, or the images on the memory card have been edited with a computer, the newest image on the memory card appears.

## Shooting Movies ( Standard Mode )



**1. Press the power button.**

**2. Select a shooting mode.**

1. Set the mode dial to  (Movie).
2. Turn the control dial to select  (Standard).



**3. Aim the camera at the subject.**



- Do not touch the microphone while recording.
- Do not press any buttons other than the shutter button. The sound that buttons make will be recorded in the movie.

#### 4. Press the shutter button lightly (halfway) to focus.

- When the camera focuses, it beeps twice and the indicator lights green.
- The exposure, focus and white balance are automatically set.



#### 5. Press the shutter button fully (all the way) to shoot.

- Recording starts.
- During the recording, the elapsed recording time and [● Rec.] will display in the LCD monitor.

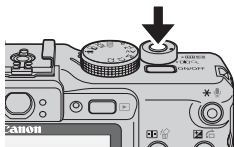

Elapsed Time

#### 6. Press the shutter button fully again to stop recording.

- The indicator will blink green and the data will be recorded onto the memory card.
- Recording will stop automatically when the maximum recording time elapses, or the built-in memory or memory card become full.

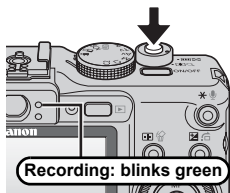

# Viewing Movies

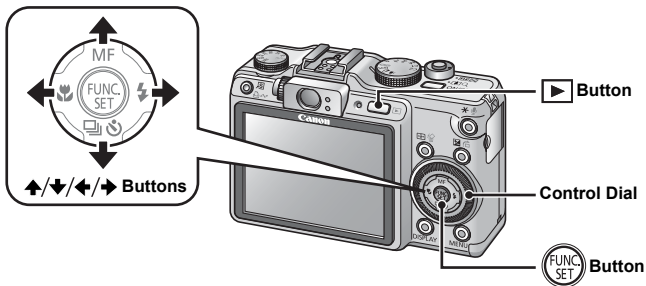







**1. Press the  (Playback) button.**

**2. Use the  or  button to display a movie and press the  button.**

- Images with a  icon are movies.
- You can also select images by turning the control dial.



**3. Use the  or  button to select  (Play) and press the  button.**





- The movie will start playing.
- If you press the **FUNC./SET** button during playback, you can pause and restart the movie.
- You can adjust the playback volume with the  or  button.



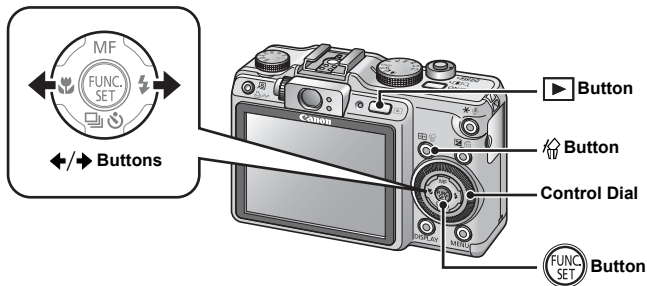

## Erasing



1. Press the  (Playback) button.
2. Use the  or  button to select an image to erase and press the  button.

You can also select images by turning the control dial.

3. Confirm that [Erase] is selected and press the  button.

To exit instead of erasing, select [Cancel].



Please note that erased images cannot be recovered. Exercise adequate caution before erasing an image.

# Printing

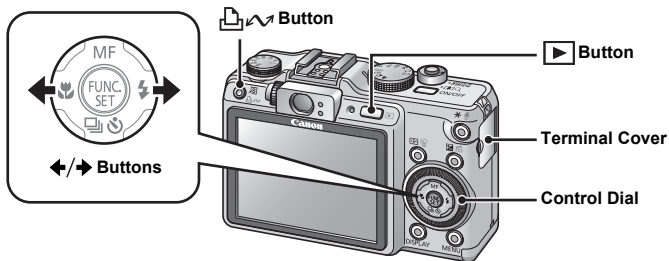

## 1. Connect the camera to the printer\*1.

- Open the terminal cover and plug the interface cable in all the way.
- See the printer's user guide for connection instructions.

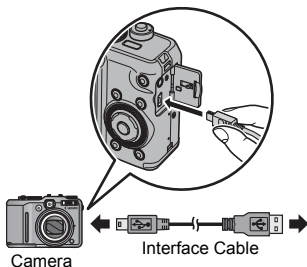

### Canon Brand Printers

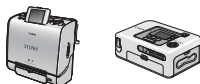

### SELPHY Series Compact Photo Printers\*2

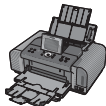





### PIXMA Series Bubble Jet Printers

\*1 Since this camera uses a standard protocol (PictBridge), you can use it with other PictBridge-compliant printers in addition to Canon-brand printers.

\*2 You can also use the CP-10/CP-100/CP-200/CP-300 card photo printers.

## 2. Turn on the printer.

### 3. Press the (Playback) button to turn on the camera.

- The  button will light blue.
- A ,  or  icon will appear in the LCD monitor if the connection is correct (the displayed icons differ according to the connected printer).
- Images with a  icon are movies.



### 4. Use the or button to select an image to print and press the button.

- The  button will blink blue and printing will start.
- You can also select images by turning the control dial.

After you finish printing, turn off the camera and the printer and disconnect the interface cable.

# Downloading Images to a Computer

## Items to Prepare

- Camera and computer
- Canon Digital Camera Solution Disk supplied with the camera
- Interface cable supplied with the camera

## System Requirements

Please install the software on a computer meeting the following minimum requirements.

### ■ Windows

<b>OS</b>	Windows Vista Windows XP Service Pack 2 Windows 2000 Service Pack 4
<b>Computer Model</b>	The above OS should be pre-installed on computers with built-in USB ports.
<b>CPU</b>	Windows Vista : Pentium 1.3 GHz or higher Windows XP / Windows 2000 : Pentium 500 MHz or higher
<b>RAM</b>	Windows Vista : 512 MB or more Windows XP / Windows 2000 : 256 MB or more
<b>Interface</b>	USB
<b>Free Hard Disk Space</b>	<ul style="list-style-type: none"> <li>• Canon Utilities               <ul style="list-style-type: none"> <li>- ZoomBrowser EX : 200 MB or more</li> <li>- PhotoStitch : 40 MB or more</li> </ul> </li> <li>• Canon Camera TWAIN Driver : 25 MB or more</li> </ul>
<b>Display</b>	1,024×768 pixels/High Color (16 bit) or better

### ■ Macintosh

<b>OS</b>	Mac OS X (v10.3 – v10.4)
<b>Computer Model</b>	The above OS should be pre-installed on computers with built-in USB ports.
<b>CPU</b>	PowerPC G3/G4/G5 or Intel Processor
<b>RAM</b>	256 MB or more
<b>Interface</b>	USB
<b>Free Hard Disk Space</b>	<ul style="list-style-type: none"> <li>• Canon Utilities               <ul style="list-style-type: none"> <li>- ImageBrowser : 300 MB or more</li> <li>- PhotoStitch : 50 MB or more</li> </ul> </li> </ul>
<b>Display</b>	1,024 × 768 pixels/ 32,000 Colors or better

## Preparing to Download Images

Ensure that you install the software first before connecting the camera to the computer.

### 1. Installing the software.

#### ■ Windows

1. Place the Canon Digital Camera Solution Disk in the computer's CD-ROM drive.
2. Click [Easy Installation].

Follow the onscreen messages to proceed with the installation.



3. Click [Restart] or [Finish] once the installation is complete.

When the installation is finished, [Restart] or [Finish] will display. Click the button that appears.



4. Remove the CD-ROM from the drive when your normal desktop screen appears.

#### ■ Macintosh

Double-click the  icon in the CD-ROM window. When the installer panel appears, click [Install]. Follow the onscreen instructions to proceed.



## 2. Connecting the camera to a computer.

1. **Connect the supplied interface cable to the computer's USB port and to the camera's DIGITAL terminal.**

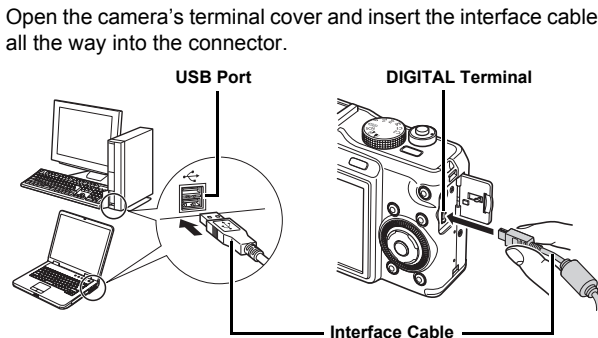

## 3. Preparing to download images to the computer.

1. Press the  (Playback) button to turn the camera on.

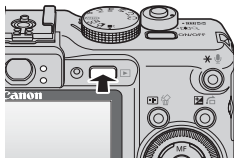

Always grasp the sides of the connector when disconnecting the interface cable from the camera's DIGITAL terminal.



If the Digital Signature Not Found window appears, click [Yes]. The USB driver will automatically finish installing onto the computer when you attach the camera and open a connection.

## ■ Windows

Select [Canon CameraWindow] and click [OK].

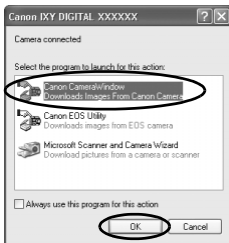

If the window above does not appear, click the [Start] menu and select [All Programs] or [Programs], followed by [Canon Utilities], [CameraWindow], [CameraWindow] and [CameraWindow].

CameraWindow appears.



Preparations for downloading images are now finished. Please proceed to the *Downloading Images Using the Camera* section (p. 31) (except Windows 2000).



With Windows 2000, you can download images using the computer. Please refer to the *Software Starter Guide* for details.

## ■ Macintosh

The following window will appear when you establish a connection between the camera and computer. If it fails to appear, click the [CameraWindow] icon on the Dock (the bar which appears at the bottom of the desktop).



Preparations for downloading images are now finished. Please proceed to the *Downloading Images Using the Camera* section (p. 31).



Please refer to the *Software Starter Guide* regarding how to download images using the computer.





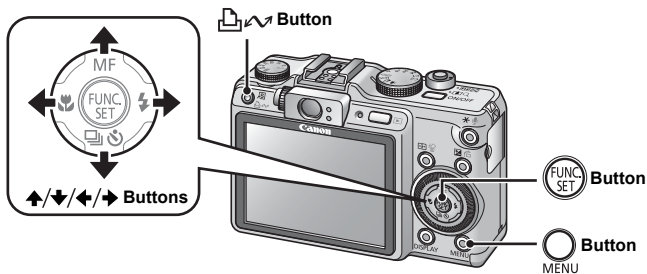

## Downloading Images Using the Camera (Direct Transfer)

Install the software before downloading images via the direct transfer method for the first time (p. 27).

Use this method to download images using camera operations (except Windows 2000).



	<b>All Images</b>	Transfers and saves all images to the computer.
	<b>New Images</b>	Transfers and saves to the computer only the images that have not been previously transferred.
	<b>DPOF Trans. Images</b>	Transfers and saves to the computer only the images with DPOF Transfer Order settings.
	<b>Select &amp; Transfer</b>	Transfers and saves single images to the computer as you view and select them.
	<b>Wallpaper</b>	Transfers and saves single images to the computer as you view and select them. The transferred images display as the background on the computer desktop.

## 1. Confirm that the Direct Transfer menu is displayed on the camera's LCD monitor.

- The  button will light blue.
- Press the **MENU** button if the Direct Transfer menu fails to appear.

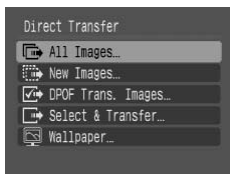

Direct Transfer Menu

### ■ All Images/New Images/DPOF Trans. Images

## 2. Use the $\uparrow$ or $\downarrow$ button to select , , or and press the button.

- The images will download. The  button will blink blue while downloading is in progress.
- The display will return to the Direct Transfer menu when the download is complete.
- Pressing the **FUNC./SET** button will cancel a download in progress.

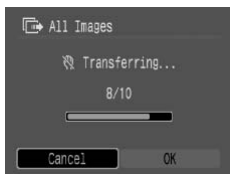

### ■ Select & Transfer/Wallpaper

## 2. Use the $\uparrow$ or $\downarrow$ button to select , or and press the button (or button).

## 3. Use the $\leftarrow$ or $\rightarrow$ button to select images to download and press the button.

- The images will download. The  button will blink blue while downloading is in progress.

## 4. Press the button after downloading finishes.

- You will return to the Direct Transfer menu.





Only JPEG images can be downloaded as wallpaper for a computer.



The option selected with the  button is retained even when the camera's power is turned off. The previous setting will be in effect the next time the Direct Transfer menu is displayed. The image selection screen will appear directly when the [Select & Transfer] or the [Wallpaper] option was last selected.

Click [x] at the bottom right of the window to close CameraWindow, the downloaded images will display on the computer.

## ■ Windows

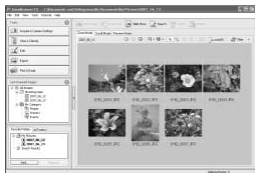

ZoomBrowser EX

## ■ Macintosh



ImageBrowser

By default, the downloaded images are saved into folders according to their shooting dates.

# System Map

Speedlite  
220EX



Speedlite  
430EX



Speedlite  
580EX II\*<sup>6</sup>



Speedlite  
Transmitter  
ST-E2



High-Power  
Flash HF-DC1



## Supplied with Camera



Neck Strap  
NS-DC6



Battery Pack  
NB-2LH\*<sup>1</sup>  
(With Terminal Cover)



Battery Charger  
CB-2LW/CB-2LWE\*<sup>1+5</sup>



Interface Cable  
IFC-400PCU\*<sup>1</sup>



Memory Card (32 MB)



AV Cable  
AVC-DC300\*<sup>1</sup>



Canon Digital Camera  
Solution Disk

### AC Adapter Kit ACK-DC20



Compact Power  
Adapter  
CA-PS700



DC Coupler  
DR-20



DC Coupler  
DR-700\*<sup>2</sup>



Power Cord

Soft Case  
SC-DC55  
series



Car Battery  
Charger  
CBC-NB2



Waterproof Case  
WP-DC21



Waterproof Case Weight  
WW-DC1

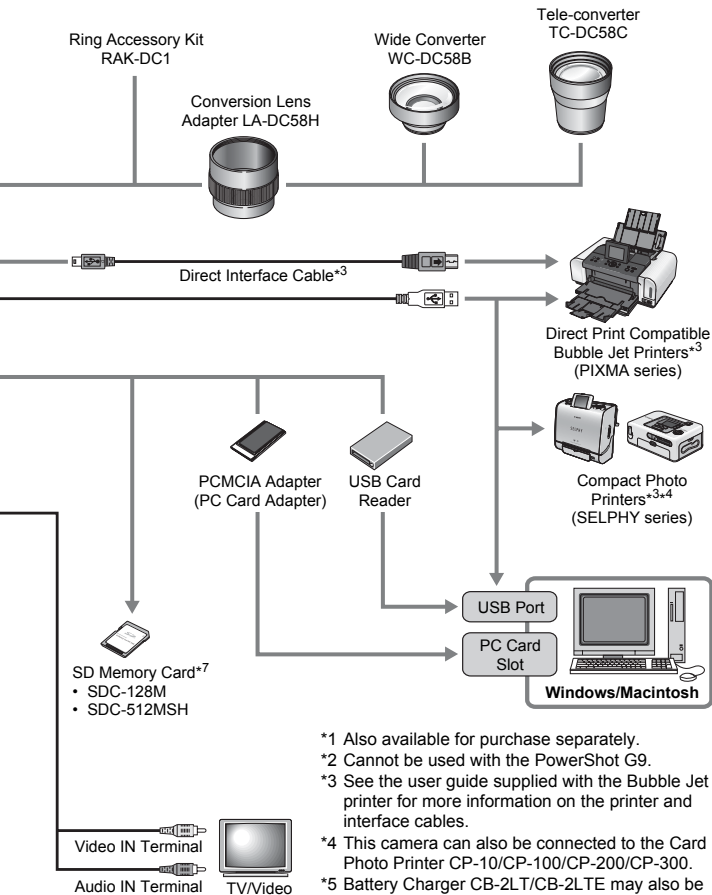

\*1 Also available for purchase separately.

\*2 Cannot be used with the PowerShot G9.

\*3 See the user guide supplied with the Bubble Jet printer for more information on the printer and interface cables.

\*4 This camera can also be connected to the Card Photo Printer CP-10/CP-100/CP-200/CP-300.

\*5 Battery Charger CB-2LT/CB-2LTE may also be used.

\*6 Speedlite 580EX may also be used.

\*7 Not sold in some regions.

## Optional Accessories

The following camera accessories are sold separately. Some accessories are not sold in some regions, or may no longer be available.

### ■ Lenses, Lens Adapter

- **Conversion Lens Adapter LA-DC58H**

This adapter is required for mounting the wide converter and tele-converter to the camera.

- **Wide Converter WC-DC58B**

Converts the focal distance of the body lens by a factor of approximately 0.75x when attached.

- **Tele-converter TC-DC58C**

Converts the focal distance of the body lens by a factor of approximately 2x when attached.

### ■ Flash

- **EX-Series Speedlites**

Speedlites for Canon EOS models. Subjects are optimally illuminated for crisp, natural images.

- Speedlite 220EX/430EX/580EX II\*

\*The Speedlite 580EX can also be used.

- **Speedlite Transmitter ST-E2**

This allows the wireless control of slave (remote) Speedlite flashes (except the Speedlite 220EX).

- **High-Power Flash HF-DC1**

This attachable supplementary flash can be used to capture photographic subjects that are too distant for the built-in flash to illuminate.

### ■ Power Supplies

- **Battery Pack NB-2LH**

Rechargeable lithium ion battery.

- **Battery Charger CB-2LW/CB-2LWE**

A battery charger for Battery Pack NB-2LH.

- **AC Adapter Kit ACK-DC20**

This is an adapter to supply power from household power outlets. Recommended to power a camera for an extended period of time or when connecting to a computer.

- Compact Power Adapter CA-PS700
- DC Coupler DR-20
- DC Coupler DR-700 (Cannot be used with the PowerShot G9)
- Power Cord

- **Car Battery Charger CBC-NB2**

Allows you to charge your camera's battery from the cigarette lighter socket of your car.

## **Other Accessories**

- **SD Memory Card**

SD Memory Cards are used to store images recorded by the camera. Canon brand cards are available in 128 MB and 512 MB capacities.

- **Interface Cable IFC-400PCU**

Use this cable to connect the camera to a computer, Compact Photo Printer (SELPHY series), or to a Bubble Jet printer\*.

\* Refer to your Bubble Jet printer user guide.

- **AV Cable AVC-DC300**

Use this cable to connect the camera to a TV set.

- **Waterproof Case WP-DC21**

You can use this case to take underwater shots at depths of up to 40 meters (130 feet), and of course it's ideal for taking worry-free pictures in the rain, at the beach, or on the ski slopes.

- **Soft Case SC-DC55A/SC-DC55B/SC-DC55C**

Protects the camera from scratching and dust. Handle with care. Leather material may discolor.

- **Ring Accessory Kit RAK-DC1**

A set of lens rings in three different colors.

## Direct Print Compatible Printers

Canon offers the following separately sold printers for use with the camera. You can produce photo quality prints quickly and easily by connecting them to the camera with a single cable and operating the camera's controls.

- **Compact Photo Printers (SELPHY series)**
- **Bubble Jet Printers (PIXMA series)**

For more information, visit your nearest Canon retailer.

### **Use of genuine Canon accessories is recommended.**

This product is designed to achieve excellent performance when used with genuine Canon accessories. Canon shall not be liable for any damage to this product and/or accidents such as fire, etc., caused by the malfunction of non-genuine Canon accessories (e.g., a leakage and/or explosion of a battery pack). Please note that this warranty does not apply to repairs arising out of the malfunction of non-genuine Canon accessories, although you may request such repairs on a chargeable basis.



**Learning More**

# Components Guide

## ■ Front View

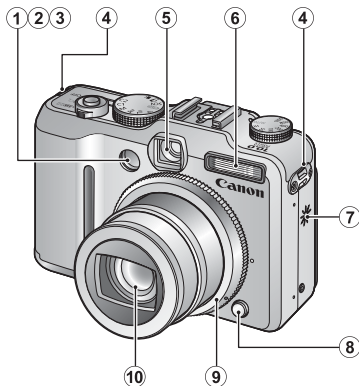

- ① AF-assist Beam (p. 49)
- ② Red-Eye Reduction Lamp (p. 113)
- ③ Self-Timer Lamp (p. 76)
- ④ Neck Strap Mounts (p. 13)
- ⑤ Viewfinder Window (p. 41)
- ⑥ Flash (p. 74)
- ⑦ Speaker
- ⑧ Ring Release Button (p. 237)
- ⑨ Ring (p. 237)
- ⑩ Lens



The LCD monitor may be covered with a thin plastic film for protection against scratches during shipment. If so, remove the film before using the camera.

## ■ Back View

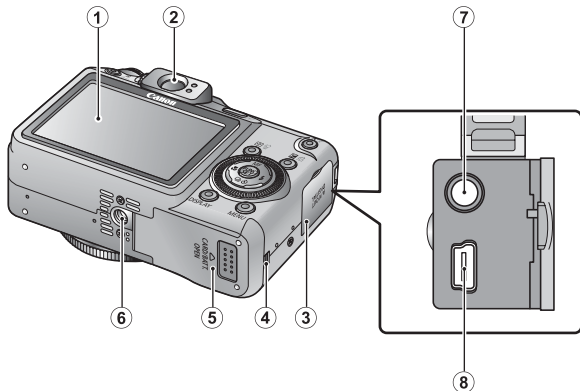

- ① LCD Monitor (p. 55)
- ② Viewfinder
- ③ Terminal Cover
- ④ DC Coupler Cable Cover (p. 235)
- ⑤ Memory Card Slot / Battery Cover (pp. 11, 12)
- ⑥ Tripod Socket
- ⑦ A/V OUT (Audio/Video output) Terminal (p. 205)
- ⑧ DIGITAL Terminal (p. 28)

### Using the Optical Viewfinder to Shoot

Turning the LCD monitor off (p. 55) and using the optical viewfinder can help conserve power while shooting.

- You can adjust the viewfinder with the diopter adjustment dial to adapt to your vision so that the subject appears in sharp focus (p. 42). Adjustments of  $-3.0$  to  $+1.0 \frac{1}{m}$  (dpt) can be made.
- You may be able to see part of the lens through the viewfinder depending on the zoom setting.
- The viewfinder has a field of vision of approximately 80% of the actual shooting image.

## ■ Controls

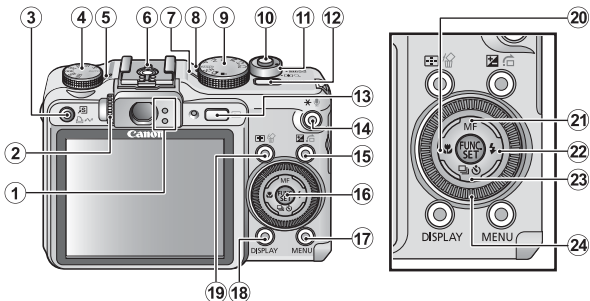

- ① Indicators (p. 44)
- ② Diopter Adjustment Dial (p. 41)
- ③ (Shortcut)/ (Print/Share) Button (pp. 24, 31, 153)
- ④ ISO Speed Dial (p. 84)
- ⑤ ISO Speed Lamp
- ⑥ Hot Shoe (p. 242)
- ⑦ Power Lamp
- ⑧ Microphone (p. 189, 191)
- ⑨ Mode Dial (pp. 16, 88)
- ⑩ Shutter Button (p. 17)
- ⑪ Zoom Lever (pp. 70, 160)  
Shooting: (Wide Angle)/  
 (Telephoto)  
Playback: (Index)/  
 (Magnify)
- ⑫ Power Button (p. 16)
- ⑬ (Playback) Button (p. 19)
- ⑭ (AE Lock/FE Lock)/  
 (Microphone) Button  
(pp. 128, 130, 189, 191)
- ⑮ (Exposure)/ (Jump)/  
Button (pp. 135, 165)
- ⑯ **FUNC./SET** (Function/Set) Button (p. 46)
- ⑰ **MENU** Button (p. 47)
- ⑱ (AF Frame Selector)/  
 (Single Image Erase) Button (pp. 116, 23)
- ⑲ (Macro)/ Button (p. 75)
- ⑲ **MF** (Manual Focus)/ Button (p. 123)
- ⑲ (Flash)/ Button (p. 74)
- ⑲ (Continuous)/ (Selftimer)/ Button  
(pp. 111, 76)
- ⑲ (Control Dial) (p. 43)
- ⑲ (Macro)/ Button (p. 75)
- ⑲ **MF** (Manual Focus)/ Button (p. 123)
- ⑲ (Flash)/ Button (p. 74)
- ⑲ (Continuous)/ (Selftimer)/ Button  
(pp. 111, 76)
- ⑲ (Control Dial) (p. 43)

## Using the Control Dial

Turning the control dial counterclockwise is equivalent to pressing the ◀ button, while turning the control dial clockwise is equivalent to pressing the ▶ button (it is equivalent to pressing the ▲ or ▼ button with some functions).

You can perform the following operations when you turn the control dial.

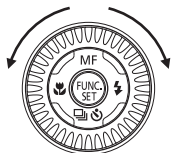

When this arrow is displayed, operation is carried out using control dial.

### ■ The Shooting Functions

- Selecting Special Scene modes (p. 89)
- Selecting / / / (pp. 74, 75, 76, 111)
- Selecting the FUNC. menu item (p. 48)
- Selecting the movie mode (p. 102)
- Selecting the shooting direction in Stitch Assist mode (p. 100)
- Selecting a shutter speed in **Tv** (p. 94)
- Selecting an aperture value in **Av** (p. 96)
- Selecting the shutter speed and the aperture value in **M** (p. 98)
- Selecting the AF Frame (p. 116)
- Adjusting the focus in manual focus mode (p. 124)
- Program Shift (p. 129)
- Adjusting the exposure (p. 135)

### ■ The Playback Functions

- Selecting an image in playback mode (pp. 19, 160, 161, 165)
- Operating when viewing/editing movies (pp. 22, 170, 172)
- Operating the sound memos or sound recorder (pp. 189, 190)
- Operating DPOF print settings and transfer settings (pp. 198, 203)

### ■ The Shooting and Playback Functions

- Selecting a menu item (pp. 46, 47)
- Selecting a time zone (p. 65)
- Changing the clock display color (p. 56)
- Registering My Camera contents (p. 208)

## Indicators

The camera indicators will light or blink under the following conditions.

### • Upper Indicator

Green: Ready to shoot

Blinking Green: Time Lapse (movie) recording/image recording/  
reading/erasing/transferring (when connected to a  
computer)

Orange: Ready to shoot (flash on)

Blinking Orange: Ready to shoot (camera shake warning)

### • Lower Indicator

Yellow: Macro mode/Manual focus mode/AF lock mode

Blinking Yellow: Focusing difficulty (camera beeps once)



Never do the following while the indicator blinks green. These actions may corrupt image data.

- Shake or jolt the camera
- Shut off the power, or open the memory card slot/battery cover

## Power Saving Function

This camera is equipped with a power saving function. The power will shut off in the following circumstances. Turn the camera on again to restore power.

Shooting Mode	Powers down approximately 3 minutes after the last control is accessed on the camera. The LCD monitor automatically turns off 1 minute* after the last control is accessed even if [Auto Power Down] is set to [Off]. Press any button other than the power button or change the camera orientation to turn the LCD monitor back on.
Playback Mode Connected to a Printer	Powers down approximately 5 minutes after the last control is accessed on the camera.

\* This time can be changed.



- The power saving function will not activate during a slide show or while the camera is connected to a computer.
- The power saving function settings can be changed (p. 52).

# Basic Operations



## Menus and Settings

Settings for the shooting or playback modes or such camera settings as the print settings, date/time and sounds are set using the FUNC. menu or the Rec., Play, Print, Set up or My Camera menu.

### ■ **Button** (FUNC. Menu)

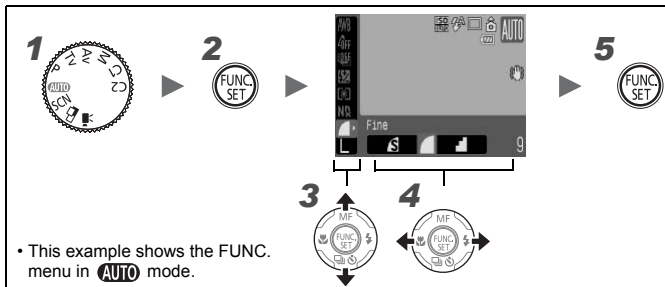
This menu sets many of the common shooting functions.



- 1** Set the mode dial to the shooting mode you want to use.
- 2** Press the  button.
- 3** Use the **↑** or **↓** button to select a menu item. Some items may not be selectable in some shooting modes.
- 4** Use the **←** or **→** button to select an option for the menu item.
  - You can select further options with the **DISPLAY** button for some options.
  - After selecting an option, you can press the shutter button to shoot immediately. After shooting, this menu will appear again, allowing you to adjust the settings easily.
  - You can also use the control dial to select an option for the menu item.
- 5** Press the  button.



## **Button** (Rec., Play, Print, Set up and My Camera Menus)

Convenient settings for shooting, playback or printing can be set with these menus.

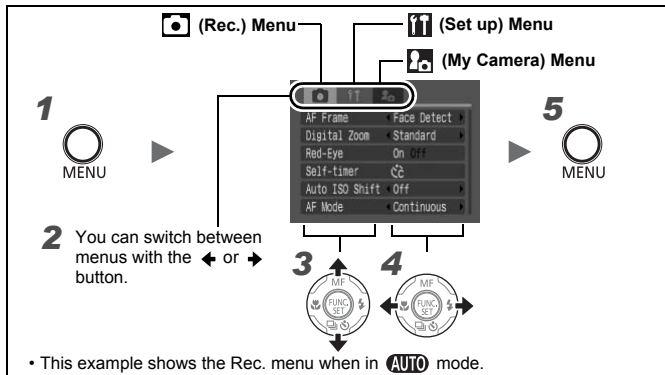





### 1 Press the button.

### 2 Use the or button to switch between menus.

- You can also use the zoom lever to switch between menus.
- The following menus are displayed.

Shooting:  Rec. /  Set up /  My Camera

Playback:  Play /  Print /  Set up /  My Camera

### 3 Use the or button to select a menu item.

- Some items may not be selectable in some shooting modes.
- You can also use the control dial to select a menu item.

### 4 Use the or button to select an option.

Menu items followed by an ellipsis (...) can only be set after pressing the **FUNC./SET** button to display the next menu. Press the **FUNC./SET** button again to confirm the setting and press the **MENU** button to return the menu screen.











### 5 Press the button.

## Menus and Default Settings

See *Functions Available in Each Shooting Mode*.



### FUNC. Menu



The icons shown below are the default settings.

	Menu Item	Reference Page		Menu Item	Reference Page
	White Balance	p. 137		ND Filter	p. 132
	My Colors	p. 140		Compression (Still Image)	p. 78
	Bracket	pp. 127, 131		Shooting Interval (Movie: Time Lapse)	p. 107
	Flash Exposure Compensation/Flash Output	pp. 149, 150		Recording Pixels (Still Image)	p. 78
	Metering Mode	p. 136		Recording Pixels (Movie)	p. 106

### Rec. Menu

\* Default setting

Menu Item	Options		Summary/ Reference Page
AF Frame			p. 116
	Face Detect*/AiAF/Center		
	FlexiZone*/Face Detect/AiAF		
Flash Control	Flash Mode	Auto*/Manual	p. 148
	Flash Exp. Comp	-2 to 0* to +2	p. 149
	Flash Output	Minimum*/Medium/Maximum	p. 150
	Shutter Sync	1st-curtain*/2nd-curtain	p. 151
	Slow Synchro	On/Off*	p. 114
	Safety FE	On*/Off	p. 152

Digital Zoom		
(Still Image)	Standard*/Off/1.5x/2.0x	p. 71
(Movies)	Standard*/Off (In standard movie mode only)	
Red-Eye	On*/Off	p. 113
Self-timer	Delay: 0 – 10*, 15, 20, 30 sec. Shots: 1 – 10* (Default setting is 3 shots.)	p. 76
Spot AE Point	Center*/AF Point	p. 136
Safety Shift	On/Off*	pp. 96, 97
Auto ISO Shift	Off*/  Button/On	p. 133
MF-Point Zoom	On*/Off	p. 124
Safety MF	On*/Off	p. 126
AF Mode	Continuous*/Single	p. 115
AF-assist Beam	On*/Off	p. 40
Review	Off/ 2 sec.* to 10 sec./Hold	You can set the length of time images display after being shot (p. 18).
Review Info	Off*/Detailed/Focus Check	p. 86
Record  + 	On/Off*	p. 81
Save Original	On/Off*	p. 147
Auto Category	On*/Off	Sets whether or not images are automatically classified into categories during shooting.* <sup>1</sup>
IS Mode		
(Still Image)	Continuous*/Shoot Only/ Panning/Off	p. 82
(Movies)	On*/Off	
Converter	Off*/ WC-DC58B /TC-DC58C	p. 241

Custom Display	LCD/Viewfinder	/  /	p. 57
	Shooting info.	Off* <sup>2</sup> / On* <sup>3</sup>	
	Grid Lines	Off* <sup>2</sup> / On* <sup>3</sup>	
	3:2 Guide	Off* <sup>2</sup> * <sup>3</sup> / On	
	Histogram	Off* <sup>2</sup> / On* <sup>3</sup>	
Set Shortcut button	*  ND WB    T AFL	p. 153	
Save Settings	<b>C1/ C2</b>	p. 109	

\*1 They are classified according to the following categories.

(People): , , or images with faces detected when [Face Detect] has been selected.

(Scenery): , ,

(Events): , , , , , ,

\*2 Default setting for LCD monitor 1.

\*3 Default setting for LCD monitor 2.

## Play Menu

Menu Item	Reference Page
Slide Show	p. 176
My Category	p. 167
Erase	p. 195
Protect	p. 192
Red-Eye Correction	p. 180
Resize	p. 187
My Colors	p. 185
Sound Recorder	p. 190
Rotate	p. 174
Transfer Order	p. 203
Transition	p. 175

## Print Menu



Menu Item	Reference Page
Print	p. 198
Select Image & Qty.	
Select Range	
Select by Date	
Select by Category	
Select by Folder	
Select All Images	
Clear All Selections	
Print Settings	

**Set up Menu** 

\* Default setting



Menu Item	Options	Summary/Reference Page
Mute	On/Off*	Set to [On] to silence all operation sounds except for the warning sounds.
Volume	Off/ 1 / 2*/ 3 / 4 / 5	Adjusts the volume of the start-up sound, operation sound, self-timer sound, shutter sound and playback sound. The volume cannot be adjusted if [Mute] is set to [On].
Start-up Vol.		Adjusts the volume of the start-up sound when the camera is turned on.
Operation Vol.		Adjusts the volume of the operation sound that beeps when any button other than the shutter button is pressed.
Selftimer Vol.		Adjusts the volume of the self-timer sound played 2 sec. before the shutter is released.
Shutter Volume		Adjusts the volume of the sound played when the shutter releases. The shutter sound does not play when a movie is recording.
Playback Vol.		Adjusts the volume of movie sounds, sound memos or sound recorder.
Audio		p. 108
Mic level	Auto*/Manual	Sets method of adjustment for the sound recording level.
Level	-40 to 0 dB	Sets the sound recording level.
Wind Filter	On/Off*	Reduces wind noise.
LCD Brightness	-7 to 0* to +7	Use the ◀ or ▶ button to adjust the brightness. You can check the brightness in the LCD monitor while you are adjusting the setting.

Power Saving		p. 45
Auto Power Down	On*/Off	Sets whether or not the camera automatically powers down after a set period of time elapses without the camera being operated.
Display Off	10 sec./20 sec./30 sec./1 min.* / 2 min./ 3 min.	Sets the length of time before the LCD monitor turns off when no camera operation is performed.
Time Zone	Home*/World	p. 65
Date/Time		p. 14
Clock Display	0–5*–10 sec./20 sec./ 30 sec./1 min./2 min./ 3 min.	p. 56
Format		Format You can also select a low level format (p. 69).
File Numbering	Continuous*/ Auto Reset	p. 158
Create Folder		p. 156
Create New Folder	Check mark (On)/ No check mark (Off)	Creates a folder during the next shooting session.
Auto Create	Off*/Daily/Monday-Sunday/Monthly	You can also set an auto creation time.
Auto Rotate	On*/Off	p. 155
Distance Units	m/cm*/ ft/in	Sets the units for the MF indicator distance unit (p. 124).
Lens Retract	1 minute*/0 seconds	Sets the lens retraction timing when switching from shooting mode to playback mode.
Language		p. 15
Video System	NTSC/PAL	p. 205
Print Method	Auto*/ 	See below* <sup>1</sup> .
Reset All		p. 68

\*1 The connection method with the printer can be changed. Although it is normally not necessary to change the setting, select  when borderless printing an image shot in  (Widescreen) mode on wide size paper using Canon compact photo printer SELPHY CP750/CP740/CP730/CP720/CP710/CP510. As this setting will be stored to memory even when the power is turned off, to print using an image size other than,  return the mode to [Auto] (however, the connection method cannot be changed while connected to a printer).

## My Camera Menu

\* Default setting

Menu Item	Summary	Reference Page
Theme	Selects a common theme for each My Camera settings item.	p. 207
Start-up Image	Sets the image displayed when the camera power is turned on.	
Start-up Sound	Sets the sound played when the camera power is turned on.	
Operation Sound	Sets the sound played when any button other than the shutter button is pressed.	
Selftimer Sound	Sets the sound played 2 seconds before the shutter releases in self-timer mode.	
Shutter Sound	Sets the sound played when the shutter button is pressed. (There is no shutter sound for movies.)	
My Camera Menu Contents	 (Off) / <b>1</b> * / <b>2</b> / 	

## Switching between Shooting Mode and Playback Mode

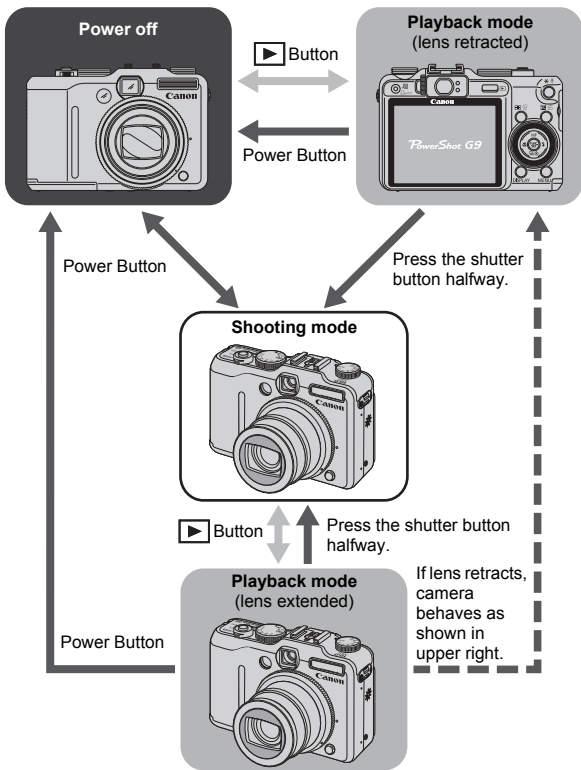

\* You can change the lens retraction timing in [Lens Retract] in the  menu (p. 52).



## Using the LCD Monitor

### 1 Press the button.

- The display mode changes as follows with each press.

#### Shooting Mode ()

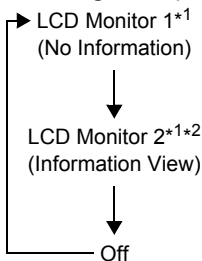

#### Playback Mode ()

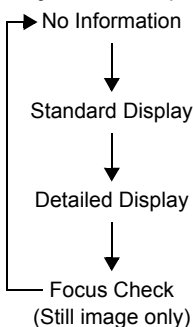



\*1 Displayed information can be changed (p. 57).

\*2 Shooting information, grid lines, and a histogram (**P**, **Tv**, **Av** or **M** only) are displayed with the default settings.

- The shooting information displays for approximately 6 sec. when a setting is changed, regardless of the selected display mode.



- The LCD monitor on or off setting is retained even after the camera power is turned off.
- The LCD monitor does not shut off in the **SCN** (, , ) mode.
- The LCD monitor will not switch to the detailed display or focus check display in magnified display (p. 160), or index playback mode (p. 161).

## Using the Clock

You can display the current date and time for a 5-second\* interval using the following two methods.

\* Default setting.



- ① Hold the **FUNC./SET** button down while turning on the power.
- ② In a shooting/playback mode, hold the **FUNC./SET** button down for more than one second.
  - If you hold the camera horizontally, it displays the time. If you hold it vertically, the time and date display.
  - You can change the display color by pressing the ◀ or ▶ button.
  - The clock display will cease when the display interval is over or when a button is operated.
  - The clock's display interval can be changed in the **[f]** menu (p. 52).
  - The clock cannot be displayed in the index playback (p. 161).

## LCD Monitor Brightness

The brightness of the LCD monitor can be changed in the following two ways.

- **Changing settings using the Set up menu (p. 51)**
- **Changing settings using the DISPLAY button (Quick-bright LCD Function)**

You can set the LCD monitor to the brightest setting regardless of the option selected in the Set up menu by pressing the **DISPLAY** button for more than one second\*.

- To restore the previous brightness setting, press the **DISPLAY** button for more than one second again.
- The next time you turn on the camera, the LCD monitor will be at the brightness setting selected in the Set up menu.

\* You cannot change the brightness of the LCD monitor with this function if you have already set it to its highest setting in the Set up menu.

## Night Display

When shooting in dark conditions, the camera automatically brightens the LCD monitor to suit the brightness of the subject\*, making it easier to frame the subject.

\* Although noise may appear and the movement of the subject shown on the LCD monitor may appear somewhat jagged, there is no effect on the recorded image. The brightness of the image displayed in the monitor, and the brightness of the actual image recorded will be different.

## Customizing Display Information



 See *Functions Available in Each Shooting Mode* (p. 270).

Shooting Mode **AUTO** **SCN** \*1 \*2 **P Tv Av M**







\*1 Only [Shooting Info] can be displayed.

\*2 [3:2 Guide] cannot be displayed.





You can set the information displayed on the LCD monitor.

LCD/Viewfinder (  /  /  )	It is possible to set one of three display modes on the LCD monitor (Display 1/Display 2/Display Off). The 3 display modes can be switched by pressing the <b>DISPLAY</b> button (p. 55).
Shooting Info	Displays shooting information (p. 59).
Grid Lines	Displays grid lines to divide the screen into 9 parts. Helps confirm the vertical and horizontal positioning of the subject (p. 59)
3:2 Guide	Helps confirm the print area for a 3:2 print*. Areas outside the printable area are grayed out (p. 59). * Images are still recorded at the standard aspect ratio of 4:3.
Histogram	Shooting Mode: <b>P</b> , <b>Tv</b> , <b>Av</b> and <b>M</b> only Displays histogram (p. 59).

Each press of the **DISPLAY** button changes the screen as follows (default setting):

















-  →  → 
- : No Information
- : Displays shooting information, grid lines and a histogram
- : Off

## 1 Select [Custom Display].

1. Press the  button.
2. Use the  or  button to select [Custom Display] in the  menu.
3. Press the  button.







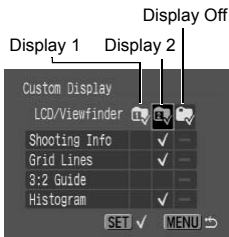

## 2 Select [LCD/Viewfinder].

1. Use the , ,  or  button to select ,  or .
- Sets LCD monitor display mode after the **DISPLAY** button is pressed.
  - If you do not wish to change the display mode, use the , ,  or  button and press the **FUNC./SET** button to display  (,  or ).
  - You cannot add  to the current active LCD/Viewfinder icon.



## 3 Make settings.

1. Use the , ,  or  button to select the items you wish to display on the LCD monitor.
  2. Press the  button to place a ✓ mark.
  3. Press the  button.
- Even though items that are grayed out can be set, they will not display in the current shooting mode.

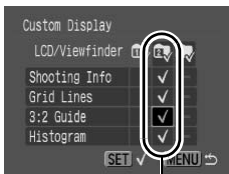

Items with ✓ are displayed.



If you press the shutter button halfway and return to the shooting screen from the custom display settings screen, the settings will not be saved.

# Information Displayed on the LCD Monitor

## Shooting Information (Shooting Mode)

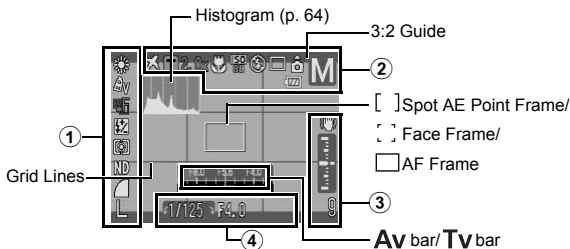

White Balance		p. 137
My Colors		p. 140
Bracket		pp. 131, 127
Flash Exposure Compensation/Flash Output		pp. 149, 150
① Metering Mode		p. 136
ND Filter		p. 132
Compression (Still image)		p. 78
Shooting Interval (Movie)		p. 107
Recording Pixels (Still image)		pp. 78, 80
Recording Pixels (Movies)		p. 102
Camera Shake		p. 61
Time Zone		p. 65
Zoom/Digital Tele-Converter		p. 71
② Macro		p. 75
ISO Speed* <sup>1</sup>		p. 84
Flash		p. 74

	Drive Mode		pp. 111, 76
	Auto Rotate		p. 155
②	Shooting Mode		p. 88
	Low Battery	(Red)	p. 229
	Movie Recording	[● Rec.] (Red)	pp. 20, 102
	MF Indicator		p. 125
	Image Stabilizer		p. 82
	Standard Exposure Index/Exposure Level Mark		p. 99
③	Wind Filter* <sup>2</sup>		pp. 108, 190
	Mic Level (Manual)* <sup>2</sup>		
	Create Folder		p. 156
	Stills: Recordable Shots Movies: Remaining Time/Elapsed Time		pp. 259, 260
	Exposure Shift Bar		p. 105
	AE Lock/FE Lock		pp. 128, 130
	Shutter Speed* <sup>1</sup>	15 – 1/2500	pp. 94, 98
④	Aperture Value* <sup>1</sup>	f/2.8 – f/11	pp. 96, 98
	Exposure Compensation	-2 ... +2	p. 135
	AF Lock		p. 123
	Manual Focus		p. 124

\*1 Displays when the shutter button is pressed halfway. During flash photography, however, the camera automatically readjusts the ISO speed, shutter speed or aperture setting to an optimal setting, which may cause the playback information to differ from the displayed information.

\*2 Displays during movie or sound recording.



If the indicator blinks orange and the camera shake warning icon (📷) displays, this indicates that a slow shutter speed may have been selected due to insufficient illumination. Use the following methods to shoot:

- Set the IS mode to any setting other than [Off] (p. 82)
- Raise the ISO speed (p. 84)
- Set the Auto ISO Shift to [On] (p. 133)
- Select a setting other than 📷 (flash off) (p. 74)
- Attach the camera to a tripod or other device

## Playback Information (Playback Mode)

### ■ Standard



①	Defined Playback		p. 165
	Remaining battery charge will display.		p. 229
②	Displayed image number/Total number of images		–
	Folder Number-File Number		pp. 156, 158
	Compression (Still Images)		p. 78
	Recording Pixels (Still Images)		p. 78
	Movie		–
③	Red-Eye Correction Function/ Image with a My Colors effect/ Resized image		pp. 180, 185, 187
	WAVE Format Sound		p. 189
	Protection Status		p. 192
	Shooting Date/Time		–



## ■ Detailed



Histogram (p. 64)

①	Auto Category/My Category		p. 167
②	Shooting Mode		p. 88
	Metering Mode		p. 136
	ISO Speed	ISO 80 ... ISO 3200	p. 84
	Shutter Speed	15–1/2500	pp. 94, 98
	Time Lapse (movie)		p. 107
③	Recording Pixels/Frame Rate (Movies)		p. 106
	Aperture Value	f/2.8–f/11	pp. 96, 98
	Exposure Compensation		p. 135
④	Flash Exposure Compensation		p. 150
	Flash Output		p. 151
	White Balance		p. 137
	ND Filter	ND	p. 132
⑤	My Colors/Color Accent/Color Swap		pp. 140, 143
	My Colors (Playback)		p. 185
	Red-Eye Reduction Function		p. 113





⑤	AF Lock/Manual Focus		pp. 123, 124
	Macro		p. 75
⑥	File size		p. 261
⑦	Compression (Still Images)		p. 260
	Movies: Movie Length		p. 260

\*1 When using Auto Exposure Bracketting (AEB) combined with exposure compensation, the compensation values displayed range from -4 to +4.

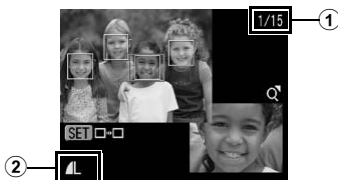

\*2 When using an externally mounted flash, the compensation values displayed range from -3 to +3.

## ■ Focus Check Display



①	Displayed image number/Total number of images		–
	Compression (Still Images)		p. 78
②	Recording Pixels (Still Images)		p. 78

The following information may also be displayed with some images.

	A sound file in a format other than the WAVE format is attached or the file format is not recognized.
	JPEG image not conforming to Design rule for Camera File System Standards (p. 254).
	Unrecognized data type



- Information for images shot on other cameras may not display correctly.
- Overexposure Warning

In the following cases, overexposed portions of the image blink.

- When reviewing an image right after shooting in the LCD monitor (information view)
- When using the detailed display mode of the playback mode

## Histogram Function

The histogram is a graph that allows you to check the brightness of an image. The greater the bias toward the left in the graph, the darker the image. The greater the bias toward the right, the brighter the image. If the image is too dark, adjust the exposure compensation to a positive value. Similarly, adjust the exposure compensation to a negative value if the image is too bright (p. 135).

Sample Histograms



Dark Image



Balanced Image



Bright Image

## Setting the World Clock



When traveling abroad, you can record images with local dates and times simply by switching the time zone setting if you pre-register the destination time zones. You can enjoy the convenience of not having to switch the Date/Time settings.

### Setting the Home/World Time Zones

#### 1 Select [Time Zone].

1. Press the button.
2. Use the or button to select the menu.
3. Use the or button to select [Time Zone].
4. Press the button.



#### 2 Select (Home).

1. Use the or button to select .
2. Press the button.

- When using for the first time, confirm that the screen to the right appears, then press the **FUNC./SET** button.







#### 3 Select a home time zone.

1. Use the or button to select a home time zone.
2. Press the button.



- To set the daylight saving option, use the or button to display. The time will advance by 1 hour.



**4 Select  (World).**





1. Use the  or  button to select .
2. Press the  button.

**5 Select a destination time zone.**

1. Use the  or  button to select a destination time zone.
  2. Press the  button.
- As in Step 3, you can set daylight saving time.

Time difference  
from home time zone





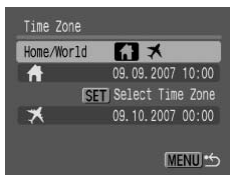

**6 Select  (Home).**

1. Use the  button to select [Home/World].
2. Use the  or  button to select .
3. Press the  button.







## Switching to the Destination Time Zone

### 1 Select [Time Zone].

1. Press the  button.
2. Use the  or  button to select the  menu.
3. Use the  or  button to select [Time Zone].
4. Press the  button.



### 2 Select (World).

1. Use the  or  button to select .
2. Press the  button.
  - To change the destination time zone, press the **FUNC./SET** button.
  - When you switch to the destination time zone,  will display on the LCD monitor.

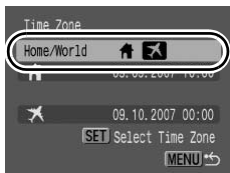

If you do not select a home time zone beforehand, you cannot configure the destination time.









If you change the date and time when the destination time zone is selected, the home time zone date and time will also change automatically.

## Resetting Settings to Their Default Values



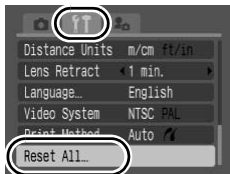

### 1 Select [Reset All].

1. Press the  button.
2. Use the  or  button to select the  menu.
3. Use the  or  button to select [Reset All].
4. Press the  button.



### 2 Make settings.

1. Use the  or  button to select [OK].
2. Press the  button.



- When returning the **C1**/**C2** registration contents to the default setting, turn the mode dial to **C1** or **C2** to operate.
- Settings cannot be reset when the camera is connected to a computer or to a printer.
- The following cannot be reset.
  - Shooting mode
  - The [Time Zone], [Date/Time], [Language] and [Video System] options in the  menu (p. 52)
  - ISO speed (p. 84)
  - White balance data recorded with the custom white balance function (p. 139)
  - Colors specified in the [Color Accent] (p. 144) or [Color Swap] (p. 145) modes
  - Newly registered My Camera settings (p. 208)

## Formatting Memory Cards



You should always format a new memory card or one from which you wish to erase all images and other data.



Please note that formatting (initializing) a memory card erases all data, including protected images and other file types.

### 1

#### Select [Format].

1. Press the button.
2. Use the or button to select the menu.
3. Use the or button to select [Format].
4. Press the button.

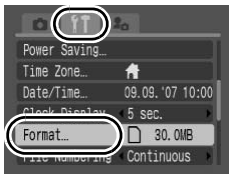

### 2

#### Make settings.

1. Use the or button to select [OK].
  2. Press the button.
- To perform a low level format, use the button to select [Low Level Format] and the or button to add a check mark.
  - You can stop formatting a card when [Low Level Format] is selected by pressing the **FUNC./SET** button. You can still use a card without problem when formatting is halted, but its data will be erased.

Displays when sound data recorded with the sound recorder is present, exercise caution before formatting memory card. (p. 190).

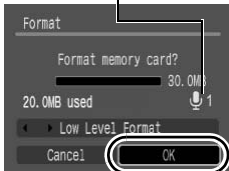

#### Low Level Format

We recommend you select [Low Level Format] when you think that the recording/reading speed of a memory card has dropped. A low level format may require 2 to 3 minutes with some memory cards.

## Commonly Used Shooting Functions



### Using the Optical Zoom



➔ See *Functions Available in Each Shooting Mode* (p. 270).

Shooting Mode **AUTO** **SCN** **P** **Tv** **Av** **M**

The zoom can be adjusted from 35 – 210 mm (focal length) in 35mm film equivalent terms. The zoom bar appears when you press the zoom lever.

#### 1 Press the zoom lever toward or .

- Wide Angle: Zooms out from the subject.
- Telephoto: Zooms in on the subject.

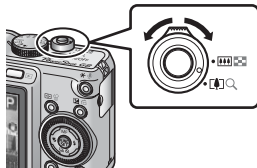



## Using the Digital Zoom/Digital Tele-Converter



➔ See *Functions Available in Each Shooting Mode* (p. 270).

Shooting Mode **AUTO** **SCN\*** **P** **Tv** **Av** **M**

\* **SCN**: Cannot be set in , and modes.

\* : [Digital Tele-converter] cannot be set.

You can combine digital zoom with optical zoom when shooting. The available shooting characteristics and focal lengths (35mm film equivalent) are as follows.

Selection	Focal Length	Shooting Characteristics
Standard	35 – 840 mm	Enables shooting at zoom factors of up to 24x with digital and optical zoom combined. The movie can only be set in the standard mode.
Off	35 – 210 mm	Enables shooting without digital zoom.
1.5x	52.5 – 315 mm	Digital zoom is fixed at the selected zoom factor, and the focal length shifts to maximum telephoto.
2.0x	70 – 420 mm	This enables a faster shutter speed and less chance of camera shake than a shot taken at the same angle of view with [Standard] or [Off].



- The digital zoom cannot be used when the LCD monitor is turned off.
- The digital zoom cannot be used in (Widescreen) or mode.

## Shooting With the Digital Zoom

### 1 Select [Digital Zoom].

1. Press the button.
2. Use the or button to select [Digital Zoom] in the menu.



## 2 Make settings.

1. Use the  $\leftarrow$  or  $\rightarrow$  button to select [Standard].
2. Press the  button.

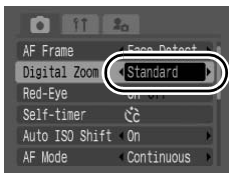

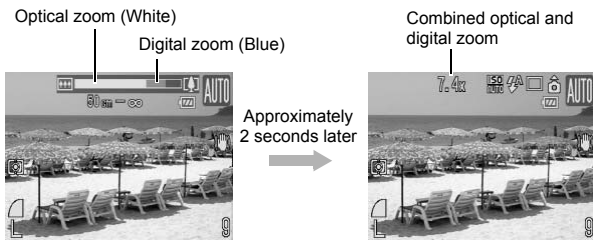

## 3 Press the zoom lever toward $\leftarrow$ and shoot.

- The combined digital and optical zoom setting will display in the LCD monitor.
- The image may appear coarse depending upon the selected recording pixels (the zoom factor appear in blue).
- Press the zoom lever toward  $\leftarrow$  to zoom out.



## About the Safety Zoom

Depending on the number of recording pixels set, you can shift from optical zoom to digital zoom without pausing up to a factor where the image quality does not deteriorate (Safety Zoom).  displays when reaching the maximum zoom factor without image deterioration (not available in .

## Safety Zoom Magnification

Recording Pixel	Optical Zoom	Digital Zoom
<b>L</b>	6.0x	
<b>M1</b>		7.4x
<b>M2</b>		9.3x
<b>M3</b>		15x
<b>S</b>		24x

### Zoom Bar Colors

- White: optical zoom (zone without deterioration)
- Yellow: digital zoom (zone without deterioration)
- Blue: digital zoom (zone with deterioration)

## Shooting With the Digital Tele-Converter

The digital tele-converter feature uses digital zoom to achieve the effects of a tele-converter (a lens used for telephoto shooting).

### 1 Select [Digital Zoom].

1. Press the  button.
2. Use the  or  button to select [Digital Zoom] in the  menu.

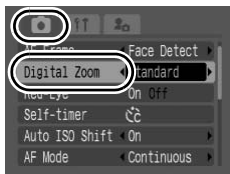

## 2 Make settings.

1. Use the  $\leftarrow$  or  $\rightarrow$  button to select [1.5x] or [2.0x].
2. Press the  button.

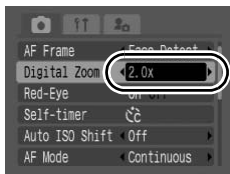

## 3 Adjust the angle of view with the zoom lever and shoot.

- **T** appears on the LCD monitor.
- Depending on the number of recording pixels set, image quality may deteriorate (**T** and the zoom factor appear in blue).

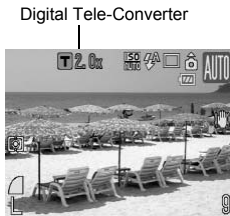

## ⚡ Using the Flash



 See *Functions Available in Each Shooting Mode* (p. 270).

Shooting Mode **AUTO** **SCN\***   **P** **Tv** **Av** **M**

\* Cannot be set in , , or  mode.

## 1 Press the $\downarrow$ button.

1. Use the  $\leftarrow$  or  $\rightarrow$  button to select the flash settings.

 : [Auto]

 : [On]

 : [Off]

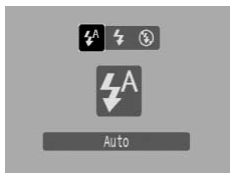

You are recommended to shoot with the camera attached to a tripod or other device if the camera shake warning icon () appears.

## Shooting Close-ups (Macro)



 See *Functions Available in Each Shooting Mode* (p. 270).

Shooting Mode **AUTO** **SCN\***   **P** **Tv** **Av** **M**

\* Cannot be set in , ,  or  mode.

Use this mode to shoot close-ups of flowers or small items. The image area at the minimum shooting distance from the end of the lens to this subject is as follows:

Maximum wide angle setting: 28 × 20 mm (1.1 × 0.79 in.)

Minimum shooting distance: 1 cm (0.39 in.)

### 1 Press the button.

1. Use the  or  button to select .





- The zoom bar will display while you adjust the zoom. In macro mode the bar will appear yellow when the zoom range prohibits focusing. The  icon will gray out and the focusing range becomes that of normal shooting mode.



Zoom Bar      Yellow bar



### To Cancel the Macro Mode:

Press the  button and use the  or  button to display  (Normal).



- Use the LCD monitor to compose close-ups in macro mode since images composed with the viewfinder may be off-center.
- Using the flash in macro mode may cause image edges to darken.

## Using the Self-Timer



 See *Functions Available in Each Shooting Mode* (p. 270).

Shooting Mode **AUTO** **SCN**<sup>\*1</sup> <sup>+2</sup> <sup>+2</sup> **P** **Tv** **Av** **M**

\*1 Cannot be set to  in ,  or  mode.



\*2 Cannot be set to .

You can set the time delay and the numbers of shots you wish to take in advance.

	<p>10 sec. Self-Timer: The shutter releases 10 seconds after the shutter button is pressed.</p> <ul style="list-style-type: none"> <li>• 2 seconds before the shutter releases, the self-timer sound beeps* quickly and the lamp will speed up.</li> </ul>
	<p>2 sec. Self-Timer: The shutter releases 2 seconds after the shutter button is pressed.</p> <ul style="list-style-type: none"> <li>• The self-timer sound beeps* quickly when the shutter button is pressed and the shutter will release 2 seconds later.</li> </ul>
	<p>Custom Timer: You can change the delay time (0 – 10, 15, 20, 30 sec.) and number of shots (1 – 10).</p> <ul style="list-style-type: none"> <li>• When a delay time of over 2 seconds is set for the [Delay] option, the self-timer sound beeps* quickly 2 seconds before the shutter releases. If multiple shots have been specified for the [Shots] option, the sound will play for the first shot only.</li> </ul>

\* May differ depending on My Camera settings.

**1 Press the  button.**

1. Use the  or  button to change the self-timer settings.

**2 Shoot.**

- When the shutter button is pressed fully, the self-timer lamp will blink (when setting the red-eye reduction function, the self-timer lamp will blink and then stay lit for the last 2 seconds).







**To Cancel the Self-Timer:**

Select .

**Changing the Delay Time and Number of Shots ()****1 Select [Self-timer].**

1. Press the  button.
2. Use the  or  button to select [Self-timer] in the  menu.
3. Press the  button.

**2 Make settings.**

1. Use the  or  button to select [Delay] or [Shots] and the  or  button to change the setting.
2. Press the  button.
3. Press the  button.





If the [Shots] option is set to 2 or more shots, the following occurs.

- The exposure and white balance are locked at the settings selected for the first shot.
- If the flash is used, the interval between shots lengthens.
- The interval between shots may lengthen when the built-in memory of the camera fills.
- Shooting will automatically cease if the memory card becomes full.

## Changing the Recording Pixels and Compression (Still Images)



➔ See *Functions Available in Each Shooting Mode* (p. 270).

Shooting Mode **AUTO** SCN **P** Tv Av M

### 1

#### Select the recording pixels.

1. Press the button.
2. Use the or button to select and the or to change the recording pixels.
3. Press the button.



### 2

#### Select the compression.

1. Press the button.
2. Use the or button to select and the or to change the compression.
3. Press the button.





## ■ Approximate Values for Recording Pixels

Recording Pixels				Purpose*
<b>L</b> Large	12M	4000 × 3000	High  Low	Printing to about A2 size (Approx. 420 × 594 mm (16.5 × 23.4 in.))
<b>M1</b> Medium 1	8M	3264 × 2448		Printing to about A3 size (Approx. 297 × 420 mm (11.7 × 16.5 in.))
<b>M2</b> Medium 2	5M	2592 × 1944		Printing to about A4 size (Approx. 210 × 297 mm (8.3 × 11.7 in.)) Printing to about Letter size prints 216 × 279 mm (8.5 × 11 in.)
<b>M3</b> Medium 3	2M	1600 × 1200		Printing postcard-size prints 148 × 100 mm (6 × 4 in.) Printing L-size prints 119 × 89 mm (4.7 × 3.5 in.)
<b>S</b> Small	0.3M	640 × 480		Sending images as e-mail attachments or shooting more images
<b>WV</b> Widescreen	4000 × 2248			Printing wide size prints (Images are recorded with 16:9 aspect ratios. Areas not recorded will display as black bars on the LCD monitor.)
<b>RAW</b> RAW	4000 × 3000			p. 80

**M**: Approximate number of recording pixels. (M is short for megapixels.)

\* Paper sizes vary according to region.

## ■ Approximate Values for Compression Settings

Compression		Purpose
<b>s</b> Superfine	High Quality	Shoot higher quality images
<b>f</b> Fine	 Normal	Shoot normal quality images
<b>n</b> Normal		Shoot more images



- See *Memory Cards and Estimated Capacities* (p. 259).
- See *Image Data Sizes (Estimated)* (p. 261).

## Changing the Image Type

➔ See *Functions Available in Each Shooting Mode* (p. 270).

Shooting Mode **AUTO** **SCN**   **P** **Tv** **Av** **M**

This camera records images as either JPEG images or RAW images.

### JPEG image (**L** / **M1** / **M2** / **M3** / **S** / **W**)

When pictures are taken as JPEG images, the images are processed inside the camera for optimum image quality, and also compressed to allow a larger number of images to be stored on the memory card. However, the compression process is irreversible, meaning that the original image data cannot be recovered once it has been compressed. See *Changing the Recording Pixels and Compression (Still Images)* (p. 78).

### RAW image (**RAW**)

RAW data is the data output by the imaging element and converted to digital data which is recorded as is.







This results in images with almost no deterioration in image quality and a higher quality than JPEG images. To view RAW images on a computer, you need to use the supplied software (ZoomBrowser EX/ImageBrowser), which also lets you broadly adjust images without deterioration in image quality. Using the software's image processing functions, you can take the adjusted image data and convert it a JPEG, TIFF or other type of image in line with your intended use.

You cannot use direct print or make print (DPOF) settings with images taken with **RAW**, however.







When downloading RAW images and simultaneously recorded JPEG images on Windows XP, be sure to use the supplied software.

# 1 Select **RAW**.

1. Press the  button.
2. Use the  or  button to select  and the  or  to select **RAW**.
3. Press the  button.



## Simultaneously Recording RAW and JPEG Images

On	Two images, a RAW image  and a JPEG image (  (Large, Fine)), will be recorded with each shot. Since a  image is also recorded, you can print the image, or view it on a computer, without using the supplied software. Both images are saved with the same file number to the same folder, and can be distinguished by their file extension.  images end with “.CR2”, while  images end with “.JPG”.
Off	Only RAW images are recorded.

# 1 Select [Record + ].

1. Press the  button.
2. Use the  or  button to select [Record  + ] in the  menu.



## 2 Make settings.

1. Use the ◀ or ▶ button to select [On] or [Off].
2. Press the  button.



## Setting the Image Stabilizer Function

 See *Functions Available in Each Shooting Mode* (p. 270).

Shooting Mode **AUTO** SCN   P Tv Av M

\* Can only be set to [Continuous].



The lens-shift type image stabilizer function allows you to minimize the camera shake effect (blurred images) when you shoot distant subjects that have been magnified or when you shoot in dark conditions without a flash.

Continuous	You can check the effect of the IS mode on image blur on the LCD monitor since the IS mode runs continually. This makes it easier to compose images and focus on subjects.
Shoot Only	Shoot Only IS mode is only activated when the shutter button is pressed. When set to [Continuous], some blurring may occur depending on the subjects. In Shoot Only mode, subjects can be taken without concern for any unnatural movement that may appear on the LCD monitor.
Panning	This option only stabilizes the effect of up and down camera motions on the image. This option is recommended for shooting objects moving horizontally.



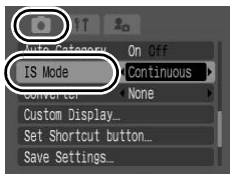



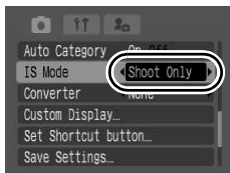

**1 Select [IS Mode].**

1. Press the  button.
2. Use the  or  button to select [IS Mode] in the  menu.

**2 Make settings.**

1. Use the  or  button to select [Continuous], [Shoot Only] or [Panning].
2. Press the  button.

**The Icons on the LCD Monitor**

[Continuous]	[Shoot Only]	[Panning]	[Converter] setting in Rec. menu	Reference Page
			None	–
			WC-DC58B	p. 241
			TC-DC58C	



- Camera shake may not be fully corrected when shooting with slow shutter speeds, such as with evening shots. Use of a tripod is recommended.
- If camera shake is too strong, it may not be fully corrected.
- Hold the camera horizontally while [Panning] (stabilization does not work when the camera is held vertically).
- If you shoot a movie after setting [IS Mode] to [Shooting] or [Panning], the setting will change to [Continuous].

## Adjusting the ISO Speed



➔ See Functions Available in Each Shooting Mode (p. 270).

Shooting Mode **AUTO** **SCN**\* **P** **Tv** **Av** **M**

\* Only available in .

Raise the ISO speed when you wish to reduce the effects of shaking hands and shoot with the flash off in a dark area or when you wish to reduce the effects of a moving subject and raise the shutter speed.

ISO speed \ Shooting mode	<b>AUTO</b>	<b>SCN</b>	<b>P</b>	<b>Tv</b>	<b>Av</b>	<b>M</b>
AUTO	○	—	○	○	○	—*2
Hi	○	—	○	—*1	—*1	—*2
ISO 80	—*1	—	○	○	○	○
ISO 100	—*1	—	○	○	○	○
ISO 200	—*1	—	○	○	○	○
ISO 400	—*1	—	○	○	○	○
ISO 800	—*1	—	○	○	○	○
ISO 1600	—*1	—	○	○	○	○
ISO 3200	—	○*3	—	—	—	—

○: Available

\*1 The ISO speed is set to Auto.

\*2 The ISO speed is set to 80.



\*3 ISO 3200 setting method (p. 88)

## 1 Select an ISO speed using the ISO speed dial.

- When selecting a settable ISO speed, the ISO speed lamp will blink orange.
- Selecting ISO AUTO sets the optimal ISO speed according to the light level when shooting. Since the ISO speed setting will automatically be raised in dark places, the camera will select a faster shutter speed and reduce the chances of camera shake.
- Selecting ISO HI (High ISO Auto)\* sets a higher sensitivity than for ISO AUTO. As the shutter speed becomes even faster, camera shake and blurred photos caused by subject movement will be reduced even more than when shooting the same scene in ISO AUTO.

\* Noise may increase in the captured image compared to ISO AUTO.



- When **SCN** (excluding ) ,  or  , the ISO speed cannot be select ISO Auto.
- When the camera is set to ISO AUTO or ISO HI and you press the shutter button halfway, the camera will set and display the ISO speed. This ISO speed will also appear in the playback information.
- The camera automatically applies noise reduction processing when you shoot at a high ISO speed.

## Checking the Focus and Peoples' Expressions (Focus Check)



➔ See *Functions Available in Each Shooting Mode* (p. 270).

Shooting Mode **AUTO** SCN **P** Tv Av M

Allows you to check the focus of an image taken.

Face Detect displays a frame adjusted to the size of a face in an image, allowing you to easily check facial expressions or whether a subject's eyes are closed. It is recommended to set [Review] to [Hold] in the menu.

### 1 Select [Review Info].

1. Press the button.
2. Use the or button to select [Review Info] in the menu.

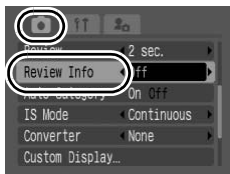

### 2 Make settings.

1. Use the or button to select [Focus Check].
2. Press the button.

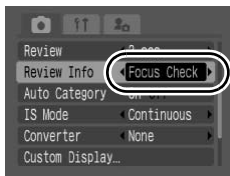



### 3 Shoot.

- The recorded image displays.
- The frame displays as follows.

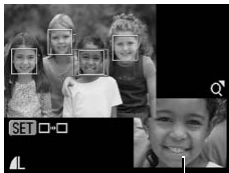

Orange frame contents

Frame color	Summary
Orange	Displays the area of the image shown at the bottom right.
White	Displays at the focal point (AF frame).

- The orange frame can be shown at a different magnification, moved or switched to a different frame (p. 163).

#### To Cancel Checking the Focus:

Press the shutter button halfway.



- You can delete an image by pressing the  button while the image is displayed (p. 23).
- You can also check the focus in playback mode (p. 162).

# Shooting Using the Mode Dial

## Mode Dial

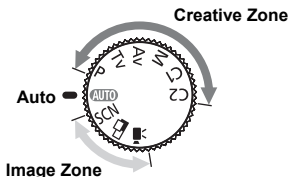

### ■ Auto

**AUTO** : The camera automatically selects settings (p. 16).

### ■ Image Zone

When a shooting mode appropriate for the shooting conditions is selected, the camera automatically adjusts settings for optimal shooting.

**SCN** : Special Scene (p. 89)

: Portrait

: Night Scene

: Night Snapshot

: Indoor

: Snow

: Fireworks

: Underwater

: Color Accent

: Landscape

: Sports

: Kids&Pets

: Foliage

: Beach

: Aquarium

: ISO 3200

: Color Swap

: Stitch Assist (p. 100)

: Movie (pp. 20, 102)

### ■ Creative Zone

You can freely select camera settings such as the exposure and aperture value to suit your shooting purposes.

**P** : Program AE (p. 93)

**Tv** : Setting the Shutter Speed (p. 94)

**Av** : Setting the Aperture (p. 96)

**M** : Manually Setting the Shutter Speed and Aperture (p. 98)

**C1, C2** : Saving Custom Settings (p. 109)

## Shooting Modes for Specific Scenes

 See *Functions Available in Each Shooting Mode* (p. 270).

Shooting Mode **AUTO** **SCN**   **P** **Tv** **Av** **M**

When a shooting mode appropriate for the shooting conditions is selected, the camera automatically adjusts settings for optimal shooting.

### SCN (Special Scene)

You can shoot with the most appropriate settings for the scene.

#### 1 Set the mode dial to SCN.

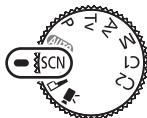

#### 2 Select a shooting mode.

1. Use the control dial to select a shooting mode.



#### Portrait

Produces a soft effect when photographing people.



#### Landscape

Optimized for shooting landscape scenes which contain both near and far subjects.



### Night Scene

Allows you to capture people against the backdrop of an evening sky or night scene. The flash is directed at the person and the shutter speed is slow, so both the person and the background can be beautifully shot.



### Sports

Shoots continuous images with autofocus. Well suited for shooting moving subjects.



### Night Snapshot

Allows you to take snapshots of people against twilight or night backgrounds by reducing the effects of camera shake even without using a tripod.



### Kids&Pets

Allows you to capture subjects that move around, such as children and pets, without missing photo opportunities.



### Indoor

Prevents camera shake and maintains the subject's true color when shooting under fluorescent or tungsten lighting.



### Foliage

Shoots trees and leaves - such as new growth, autumn leaves or blossoms - in vivid colors.



### Snow

Shoots without a blue tinge and without making people appear dark against a snowy background.



### Beach

Shoots without making people appear dark near water or sand where reflected sunlight is strong.



### Fireworks

Captures fireworks in the sky sharply and at optimal exposure.



### Aquarium

Selects the optimal ISO speed, white balance and color balance to capture fish and other items in an indoor aquarium.



### Underwater

Appropriate for shooting images with Waterproof Case WP-DC21 (sold separately). This mode uses an optimal white balance setting to reduce bluish tones and record images with a natural hue.



### ISO 3200

Shoots with the ISO speed set to 3200, twice as fast as ISO 1600. Use when high speed is required. Avoids blurring of the subject and the effects of camera shake. Recording pixels are fixed at **M3** (1600 × 1200).



### Color Accent











Use this option to have only the color specified in the LCD monitor remain and to transform all others to black and white (p. 144).



### Color Swap

Use this option to transform a color specified in the LCD monitor into another (p. 145).



- The shutter speed is slow in  or  mode. Always use a tripod to avoid camera shake.
- In , , , , , , ,  or  mode, the ISO speed may increase and cause noise in the image depending on the scene being shot.



To shoot underwater, install the camera in Waterproof Case WP-DC21 (sold separately). We recommend you use it for rain, shooting at ski resorts or beaches.

## P Program AE



➔ See *Functions Available in Each Shooting Mode* (p. 270).

Shooting Mode **AUTO** **SCN** **P** **Tv** **Av** **M**

The camera automatically sets the shutter speed and aperture value to match the brightness of the scene. You can set the ISO speed, exposure compensation and white balance.

### 1 Set the mode dial to P.



### 2 Shoot.



- When a correct exposure cannot be obtained, the shutter speed and aperture values are shown in red on the LCD monitor when the button is pressed halfway. Use the following shooting methods to obtain the correct exposure and make them show in white.
  - Use the flash (p. 74).
  - Adjust the ISO Speed (p. 84).
  - Change the metering method (p. 136).
  - Set the ND filter on (p. 132).
- You can change the combinations of shutter speeds and aperture values without altering the exposure (p. 129).

## Tv Setting the Shutter Speed



➔ See *Functions Available in Each Shooting Mode* (p. 270).

Shooting Mode **AUTO** **SCN** **P** **Tv** **Av** **M**

When you set the shutter speed, the camera automatically selects an aperture value to match the brightness.

Faster shutter speeds allow you to catch an instantaneous image of a moving subject, while slower speeds create a flowing effect and allow you to shoot without a flash in dark areas.

### 1 Set the mode dial to Tv.



### 2 Set the shutter speed.

1. Use the control dial to change the shutter speed.

- When using the control dial, the **Tv** bar will be displayed and the shutter speed can be changed.

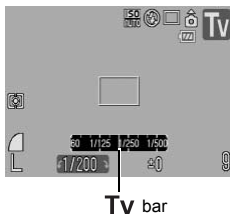

Tv bar

### 3 Shoot.

- If you press the shutter button halfway and the aperture value is shown in red, the image is underexposed (insufficient light) or overexposed (too much light). Use the control dial to adjust the shutter speed until the aperture value shows in white.





The nature of CCDs is such that noise in the recorded image increases at slow shutter speeds. This camera, however, applies special processing to images shot at shutter speeds slower than 1.3 seconds to eliminate the noise, thereby producing high-quality images (Nevertheless, a certain amount of processing time may be required before the next image can be shot).



- The aperture value and shutter speed change according to the zoom state as follows.

	Aperture Value	Shutter Speed (seconds)
Maximum Wide Angle	f/2.8	15 to 1/1600
	f/3.2 – 3.5	15 to 1/2000
	f/4.0 – 8.0*	15 to 1/2500
Maximum Telephoto	f/4.8	15 to 1/1600
	f/5.6 – 6.3	15 to 1/2000
	f/7.1 – 8.0*	15 to 1/2500

\* Depending on the shooting conditions, the aperture value can increase to f/11 in **AUTO**.

- The fastest shutter speed for built-in flash synchronization is 1/500 second. The camera automatically resets the shutter speed to 1/500 second or slower, if a faster speed is selected.

### Shutter Speed Display

- The numbers in the table below indicate the shutter speed in seconds. 1/160 indicates 1/160 second. Also, quote marks indicate the decimal place, so that 0"3 indicates 0.3 second and 2" indicates 2 seconds.

15" 13" 10" 8" 6" 5" 4" 3"2 2"5 2" 1"6 1"3 1" 0"8 0"6 0"5 0"4
0"3 1/4 1/5 1/6 1/8 1/10 1/13 1/15 1/20 1/25
1/30 1/40 1/50 1/60 1/80 1/100 1/125 1/160 1/200 1/250
1/320 1/400 1/500 1/640 1/800 1/1000 1/1250 1/1600 1/2000
1/2500

- You can change the combinations of shutter speeds and aperture values without altering the exposure (p. 129).

### About Safety Shift

If you set [Safety Shift] to [On] (p. 49) in the  menu and press the shutter button halfway, the camera automatically changes the shutter speed or aperture value to obtain the correct exposure if necessary. The safety shift function does not work when the flash is on.

## Av Setting the Aperture



 See *Functions Available in Each Shooting Mode* (p. 270).

Shooting Mode **AUTO** **SCN**   **P** **Tv** **Av** **M**

The aperture adjusts the amount of light entering through the lens. When you set the aperture, the camera automatically selects a shutter speed to match the brightness.

Selecting a lower aperture value (opening the aperture) allows you to blur the background and create a beautiful portrait.

A higher aperture value (closing the aperture) brings the entire range from foreground to background into focus. The larger the aperture value, the greater the range of the image brought into clear focus.

### 1 Set the mode dial to Av.

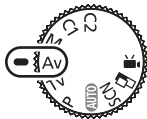

### 2 Set the aperture value.

- Use the control dial to change the aperture value.
  - When using the control dial, the **Av** bar will be displayed and the aperture value can be changed.



Av bar

### 3 Shoot.

- If you press the shutter button halfway and the shutter speed is shown in red, the image is underexposed (insufficient light) or overexposed (too much light). Use the control dial to adjust the aperture value until the shutter speed shows in white.



Some aperture values cannot be selected depending on the zoom position (p. 95).



- In this mode, the shutter speed range with synchronized flash is 1/60 second to 1/500 second. The aperture value setting may therefore be changed automatically to match the synchronized flash speed even if its value was set previously.

#### Aperture Value Display

- The larger the aperture value, the smaller the lens aperture.  

F2.8	F3.2	F3.5	F4.0	F4.5	F4.8	F5.0	F5.6	F6.3	F7.1	F8.0
------	------	------	------	------	------	------	------	------	------	------
- You can change the combinations of shutter speeds and aperture values without altering the exposure (p. 129).

#### About Safety Shift

If you set [Safety Shift] to [On] (p. 49) in the  menu and press the shutter button halfway, the camera automatically changes the shutter speed or aperture value to obtain the correct exposure if necessary. The safety shift function does not work when the flash is on.

## M Manually Setting the Shutter Speed and Aperture

 See *Functions Available in Each Shooting Mode* (p. 270).

Shooting Mode **AUTO** **SCN**   **P** **Tv** **Av** **M**

You can manually set the shutter speed and aperture to shoot images.

### 1 Set the mode dial to M.

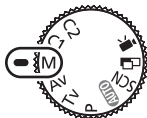

### 2 Set the shutter speed and aperture value.

1. Press the  button to select the shutter speed or aperture value.
  2. Use the control dial to change the shutter speed or aperture value.
- When using the control dial, the **Tv** bar or **Av** bar will be displayed and the aperture value can be changed.

### 3 Shoot.

- The exposure level indicator appears, and you can check the difference between the selected exposure and the correct exposure\*. If the difference is more than  $\pm 2$  stops, the selected exposure appears in red on the LCD monitor.

- When you press the shutter button halfway, the difference between the correct exposure\* and the selected exposure appears on the LCD monitor. If the difference is more than 2 stops, “-2” or “+2” appears on the LCD monitor in red.

\* The standard exposure is calculated by measuring the brightness according to the selected metering method.

- When you press the **X** button, the shutter speed or aperture value will automatically shift to obtain the correct exposure (except when the **MF** icon is selected). When the shutter speed is selected, the aperture value will change. When the aperture is selected, the shutter speed will change.

Exposure Level Indicator



Correct Exposure



- If the zoom is adjusted after these values are set, the aperture value or the shutter speed may change in accordance with the zoom position (p. 95).
- The brightness of the LCD monitor matches the selected shutter speed and aperture value. When you select a fast shutter speed or shoot a subject in a dark place, set it to  (Flash on) or attach an externally mounted flash, the image will always be bright.

## Shooting Panoramic Images (Stitch Assist)

 See *Functions Available in Each Shooting Mode* (p. 270).

Shooting Mode **AUTO** **SCN**  **P** **Tv** **Av** **M**

Stitch Assist can be used to shoot overlapping images that can later be merged (stitched) to create one panoramic image on a computer.



The overlapping seams of several adjacent images can be joined into a single panoramic image.



### 1 Set the mode dial to .

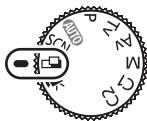

## 2 Select the shooting direction.

1. Use the control dial to select a shooting sequence.

You can select from the following five shooting directions.

- → Left to right horizontally
- ← Right to left horizontally
- ↑ Bottom to top vertically
- ↓ Top to bottom vertically
- Clockwise starting at the top left shooting 4 images.



## 3 Shoot the first frame of the sequence.

- The exposure and white balance are set and locked with the first image.



## 4 Compose the second image so that it overlaps a portion of the first and shoot.

- You can press the ↑, ↓, ← or → button to return to the previously recorded image to retake the shot.
- Minor discrepancies in the overlapping portions can be corrected when the images are stitched together.

## 5 Repeat the procedure for additional images.

- A sequence may contain up to 26 images.

## 6 Press the button after the last shot.



- You cannot display the images on a TV when shooting in Stitch Assist mode.
- The settings for the first image are applied to the second image onward.



- Use PhotoStitch, a supplied software program, to merge the images on a computer.
- When the  button is pressed, you can switch between the items which you can set.
  - Exposure compensation/Shooting direction selection

## Movie Shooting



 See *Functions Available in Each Shooting Mode* (p. 270).

Shooting Mode **AUTO** SCN   **P** Tv Av M

The following movie modes are available.

The recording time will differ according to the memory card used (p. 260).



### Standard

You can select the recording pixels and record until the memory card is full\*<sup>1</sup>.

The digital zoom can be used while shooting in this mode (p. 71).

- Maximum Size: 4 GB/movie\*<sup>2</sup>



### High Resolution

Use this to display images at large sizes on computer monitors.

- Maximum Size: 4 GB/movie\*<sup>2</sup>



### Compact

Since there are few recording pixels and also the data size is small, this mode is convenient for sending movies as e-mail attachments or when the memory card capacity is low.

- Maximum Clip Length: 3 minutes



**Color Accent, Color Swap**

You can have only the specified color remain and change all others into black and white, or change a specified color into a different color. (pp. 144, 145).

As with the Standard mode, you can select the recording pixels and frame rate and record until the memory card is full\*<sup>1</sup>.

- Maximum Size: 4 GB/movie \*<sup>2</sup>

**Time Lapse**

Select a shooting interval (1 or 2 sec.) to have a single frame shot at that interval. When played back, two hours worth of recorded frames is compressed to 8 minutes (1-sec. interval) or 4 minutes (2-sec. interval). You can record events from a fixed perspective, such as the spectacle of a flower budding over time, or view changing elements in a short period. Sound cannot be recorded in this mode.

- Maximum recording session: 2 hours

\*<sup>1</sup> When a super high-speed memory card is used, such as the recommended SDC-512MSH.



\*<sup>2</sup> Even if the clip size has not reached 4 GB, recording will stop at the moment the clip length reaches 1 hour. Depending on memory card capacity and data write speed, recording may stop before the file size reaches 4 GB or the recording time reaches 1 hour.

**1 Set the mode dial to .****2 Select a movie mode.**

1. Select a movie mode using the control dial.



### 3 Shoot.

- Pressing the shutter button halfway automatically sets the exposure, focus and white balance settings.
- Pressing the shutter button fully starts recording video and sound simultaneously.
- During shooting, the recording time and [● Rec] appear on the LCD monitor. The indicator will blink green in  mode.
- Pressing the shutter button fully again stops recording. Recording will stop automatically under the following circumstances.
  - When the maximum recording time elapses
  - When the built-in memory or memory card becomes full
- The elapsed time from the start of recording to the finish will display on the LCD monitor when playing back a  recording, but the actual playback time will be shorter than the displayed time.





- You are recommended to use a memory card that has been formatted in your camera to shoot movies (p. 69). The card supplied with the camera may be used without further formatting.
- Be careful of the following while recording.
  - Try not to touch the microphone (p. 42).
  - If you press a button, the sound of the button being pressed will also be recorded.
  - The camera will automatically adjust the exposure and white balance to suit the shooting conditions during a recording. Please note, however, that the sounds made by the camera while automatically adjusting the exposure may also be recorded.
- The focus and optical zoom settings remain fixed for subsequent frames at the values selected for the first frame.









- The following operations are available before movie recording:
  - AF lock: Pressing the **MF** button activates AF lock with the current conditions. **MF** and the MF indicator display on the LCD monitor, and you can check the distance to the subject. You can cancel AF lock by pressing the **MF** button again.
  - Manual focus (p. 124)
  - AE lock, Exposure shift: Press the **\*** button to enable AE lock. The exposure shift bar appears on the LCD monitor, and exposure can be changed using the control dial. You can cancel AE lock by pressing the **\*** button again. Pressing the **MENU** button or changing the white balance settings, My Colors settings or the shooting mode, also cancels AF lock.
- In  mode, the selected power saving option (p. 45) determines if the LCD monitor turns off or not. You can turn the LCD monitor on by pressing any button other than the power button or shutter button.
- QuickTime is required to play back movies (Data type: AVI/ Compression method: Motion JPEG) on a computer (Windows 2000 only).

## Changing Movie Recording Pixels

You can change the recording pixels and frame rate when the movie mode is set to  (Standard),  (Color Accent) or  (Color Swap).













### 1 Select a recording pixels.

1. Press the  button.
2. Use the  or  button to select  and use the  or  to change the recording pixels.
3. Press the  button.



## Movie Recording Pixels and Frame Rates

Frame rates indicate the number of frames recorded or played back each second. The higher the frame rate, the smoother the appearance of motion.

 Standard	 *1	640 × 480 recording pixels, 30 frames/sec.
 Color Accent	 *2	640 × 480 recording pixels, 30 frames/sec., LP (Long Play)
 Color Swap		320 × 240 recording pixels, 30 frames/sec.
 High Resolution		1024 × 768 recording pixels, 15 frames/sec.
 Compact		160 × 120 recording pixels, 15 frames/sec.
 Time Lapse		640 × 480 recording pixels, 15 frames/sec.*3

\*1 Default setting.

\*2 When priority is on movie length rather than image quality, select [LP] (Long Play). You can shoot for twice as long in this mode compared to a file of the same size shot in the other modes.

\*3 Frame rate during playback.



- See *Estimated Sound Recorder File Sizes and Recording Times* (p. 260).
- See *Image Data Sizes (Estimated)* (p. 261).

## Changing the Shooting Interval (Time Lapse)

1







### Select .

1. Use the control dial to select .



2

### Select a shooting interval.

1. Press the  button.
2. Use the  or  button to select  and use the  or  button to select a shooting interval (1 sec./2 sec.).
3. Press the  button.



Recordable Duration

- The recordable duration will display.

## Setting the Recording Functions



➔ See *Functions Available in Each Shooting Mode* (p. 270).

Shooting Mode **AUTO** SCN P Tv Av M

The microphone level (sound recording level) and wind filter settings can be changed.

### 1 Select [Audio].

1. Press the button.
2. Use the or button to select the menu.
3. Use the or button to select [Audio].
4. Press the button.



### 2 Set the microphone level.

1. Use the or button to select [Mic Level].
  2. Use the or button to select [Auto] or [Manual].
- When in [Manual] mode, press the button, then set the sound recording level (recording volume) with the or button.



### 3 Set the wind filter.

1. Use the  $\uparrow$  or  $\downarrow$  button to select [Wind Filter].
2. Use the  $\leftarrow$  or  $\rightarrow$  button to select [On] or [Off].
3. Press the  button.

- Recommended to set to [On] when the wind is strong.



- When [Mic Level] is set to [Auto], the recording volume is automatically adjusted to avoid sound distortion.
- Wind filter suppresses noise when the wind is strong.

## C Saving Custom Settings



 See *Functions Available in Each Shooting Mode* (p. 270).





Shooting Mode **AUTO** SCN   **P Tv Av M**

You can save frequently used shooting modes and various shooting settings to the **C** (Custom) mode. When necessary, you can then shoot images with previously saved settings by simply turning the mode dial to **C1** or **C2**. Settings that are not memorized when the shooting mode is changed or when the power is turned off (such as continuous shooting or self-timer) are also remembered.

## 1 Switch to the shooting mode you wish to save and set the settings.



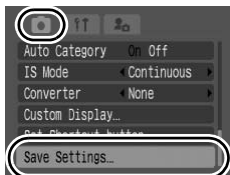

- Functions which can be saved in **C1** or **C2**.
  - Shooting mode (**P**, **Tv**, **Av**, **M**)
  - Items which can be set in **P**, **Tv**, **Av** and **M** modes (pp. 93–99)
  - Rec. menu settings
  - Zoom location
  - Manual focus location
- To change some of the settings saved in **C1** or **C2** (other than shooting mode), select **C1** or **C2**.

## 2 Select [Save Settings].

1. Press the  button.
2. Use the  or  button to select [Save Settings] in the  menu.
3. Press the  button.



## 3 Register.

1. Use the  or  button to select [**C1**] or [**C2**].
2. Press the  button.
3. Press the  button.



- The ISO speed setting cannot be saved. When shooting with **C1/C2**, set the ISO speed with the ISO speed dial.
- The setting contents do not influence other shooting modes.
- Saved settings can be reset (p. 68).



# Advanced Shooting Functions

## Continuous Shooting

 See *Functions Available in Each Shooting Mode* (p. 270).

Shooting Mode **AUTO** **SCN**\*1   **P** **Tv** **Av** **M**

\*1 Cannot be set in  and  modes.



In this mode, the camera shoots continuously while the shutter button is held down.

If you use the recommended memory card\*2, you can shoot continuously (smooth continuous shooting) at a set shooting interval until the memory card is full (p. 259).

### \*2 Recommended Memory Card:

Super high-speed SDC-512MSH memory card (sold separately) to which low-level formatting (p. 69) is conducted immediately before shooting.





- This reflects standard shooting criteria established by Canon. Actual results may vary according to the subject and shooting conditions.
- Even if continuous shooting suddenly stops, the memory card may not be full.

		Shooting speed (Image/sec.)	Focus while shooting	Display on the LCD monitor
	<b>Continuous</b> You can shoot continuously at a short shooting interval.	Approx. 1.5 images	Fixed*	Recorded image
	<b>Continuous Shooting AF</b> You can shoot continuously with auto focus.	Approx. 0.7 images	Auto focus	Subject right before shooting
	<b>Continuous Shooting LV (Live View)</b> You can shoot continuously with a manually set focus position while confirming the subject.	Approx. 0.8 images	Fixed*	Subject right before shooting

\*1 The focus position of first image is fixed.

-  (Large/Fine) mode.

## 1 Press the button.

1. Use the  or  button to select  or .



- When  and manual focus modes, you can select .

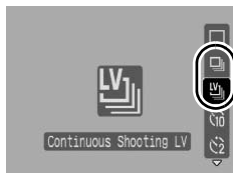







## 2 Shoot.

- The camera will continue to record successive images while the shutter button is held down. Recording will cease when the shutter button is released.

### To Cancel Continuous Shooting:

Follow Step 1 to select .



- When in ,  will be the default setting.  cannot be set.
-  cannot be set in the  and manual focus modes.
- Cannot be set while in the focus bracketing shooting mode or AEB shooting mode.
- AF frame will be set to [Center] in  mode.
- The interval between shots lengthens when the built-in memory of the camera fills.
- If the flash is used, the interval between shots lengthens because the flash must charge.

## Setting the Red-Eye Reduction Function

 See *Functions Available in Each Shooting Mode* (p. 270).



Shooting Mode **AUTO** **SCN**\*<sup>1</sup>   **P** **Tv** **Av** **M**

\*1 Cannot be set in , , and  modes.

You can set whether or not the red-eye reduction\*<sup>2</sup> lamp automatically fires with the flash.



\*2 This feature reduces the effect of light reflecting back from the eyes and making them appear red.

### 1 Select [Red-Eye].

1. Press the  button.
2. Use the  or  button to select [Red-Eye] in the  menu.



### 2 Make settings.

1. Use the  or  button to select [On] or [Off].
2. Press the  button.



## Setting the Slow Synchro



➔ See Functions Available in Each Shooting Mode (p. 270).

Shooting Mode **AUTO** **SCN** **P** **Tv** **Av** **M**

The flash timing is adjusted to slow shutter speeds. This reduces the chance that only the background will appear dark when a night scene or an interior shot is taken.

### 1 Display the Flash Settings screen.

1. Hold the button down for more than one second.



### 2 Make settings.

1. Use the or button to select [Slow Synchro] and use the or button to select [On] or [Off].
2. Press the button.



- This will be fixed to [On] in the , and modes in the **SCN** mode.
- When [Slow Synchro] set to [On], camera shake may become a factor. Use of a tripod is recommended.
- You can also set in [Flash Control] in the menu.

## Switching between Focus Settings



➔ See *Functions Available in Each Shooting Mode* (p. 270).

Shooting Mode **AUTO** **SCN\*** **P** **Tv** **Av** **M**

\* In mode only [Continuous] is available.

\* In and modes only [Single] is available.

You can set the AF mode.

Continuous	The camera is continually focusing on whatever it is aimed even when the shutter button is not pressed, allowing you to shoot without missing opportunities.
Single	The camera only focuses when the shutter button is pressed halfway, conserving battery power.

### 1 Select [AF Mode].

1. Press the button.
2. Use the or button to select [AF Mode] in the menu.

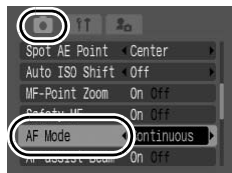

### 2 Make settings.

1. Use the or button to select [Continuous] or [Single].
2. Press the button.

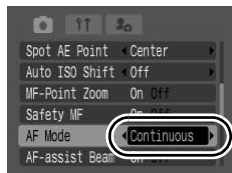

This will be set when the AF frame mode is set to [Face Detect], [FlexiZone] or [Center]. This will be fixed to [Single] when the AF frame mode is set to [AiAF] (p. 116).

## Selecting an AF Frame Mode



➔ See *Functions Available in Each Shooting Mode* (p. 270).

Shooting Mode **AUTO** **SCN**\* **M**

\* This will be fixed to [Center] in and modes.

The AF frame indicates the area of the composition on which the camera focuses. You can set the AF frame in the following ways.

	Face Detect	You can have the camera automatically detect the position of a face and use this data to set the focus and exposure* while shooting. In addition, the camera will meter the subject so that the face is correctly illuminated when the flash fires. * Only in evaluative metering mode (p. 136).
	AiAF	The camera automatically selects between 9 AF frames to focus on according to the shooting conditions.
	Center	<b>Shooting Mode: <b>AUTO</b>/SCN</b> The AF frame will be fixed to center. This is convenient for making sure the focus is exactly where you want it.
	FlexiZone	<b>Shooting Mode: <b>P</b>/Tv/Av/M</b> The AF frame can be moved manually to the desired area (FlexiZone). This is convenient for making sure the focus is exactly where you want it.

### ■ Selecting [Face Detect]

# 1

#### Select [AF Frame].

1. Press the button.
2. Use the or button to select [AF Frame] in the menu.



## 2 Make settings.

1. Use the ◀ or ▶ button to select [Face Detect].

2. Press the  button.

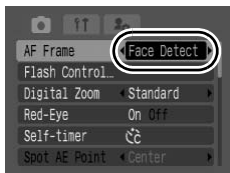

- Up to three frames display where the camera detects faces. The frame the camera judges to be the main subject appears in white while the others appear in gray.
- See *Selecting a Subject to Focus (When [Face Detect] is Selected)* (p. 119).



## 3 Shoot.

- A maximum of 9 green AF frames will appear when the shutter button is pressed halfway and the camera focuses. If the camera cannot focus, the AF frames will not appear.



- [Face Detect] cannot be used when the LCD monitor is turned off.
- You can switch between the AF Frame modes, pressing the  button followed by pressing the **MENU** button or the  button. Pressing the  button again completes the setting.
- If the white frame fails to appear and only gray frames appear, or if a face is not detected, you can change the focusing method (p. 115) as follows.
  - [Single]: The camera selects automatically one frame out of 9 AF frames and focuses.
  - [Continuous]: The camera focuses on the subject in the center AF frame.
- The camera may mistakenly identify non-human subjects as a face.
- In certain cases, faces may not be detected.

Examples:

  - Faces near the screen edges or faces that appear extremely small, large, dark or bright in relation to the overall image.
  - Faces turned to the side or at a diagonal, or faces with a portion hidden.



## Selecting a Subject to Focus (When [Face Detect] is Selected)

Once the focus is fixed to a subject's face, the frame can be set to follow the subject (Face Select and Track). The camera displays up to 35 frames of the faces detected.

### 1 When a face is detected, press the button.



- The AF frame displays as a double frame  in green.



### 2 Select a subject using the **←** or **→** button.

- When pressing the **DISPLAY** button, you can confirm how many faces the camera recognizes.
- Each time you press the **MENU** button (or the **\***  button), the AF frame mode can be switched.

### 3 Press the button.

- A white double frame  will display on the selected subject's face.
- When pressing the shutter button halfway, a green AF frame displays. However, if the subject is hard to focus on, a yellow frame displays.
- Continuously pressing the  button releases the selection.

## ■ Selecting [AiAF], [Center] or [FlexiZone]

1



### Select [AF Frame].

1. Press the  button.
2. Use the  or  button to select [AF Frame] in the  menu.



2



### Make settings.

1. Use the  or  button to select [AiAF], [Center] or [FlexiZone].

2. Press the  button.

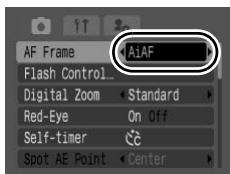
- See *Changing the AF Frame Size ([AiAF] or [FlexiZone] Selected)* (p. 121).
- See *Moving the AF Frame ([AiAF] or [FlexiZone] Selected)* (p. 122).



- After pressing the  button, you can use the **MENU** button (or  button) to switch the AF frame mode. Pressing the  button again sets the AF frame mode.
- FlexiZone cannot be used with the LCD monitor is turned off. If [AF Frame] is set to [FlexiZone], the AF frame mode will change to [Center] when the monitor is turned off.
- The AF frame appears as follows when the shutter button is pressed halfway.
  - Green: Shooting preparations complete
  - Yellow: Focusing difficulty (when the AF frame is set to [Center] or [FlexiZone].)
  - No AF frame: Focusing difficulty (when the AF frame is set to [AiAF].)

## Changing the AF Frame Size ([AiAF] or [FlexiZone] Selected)

You can change the size of the AF frame to match the size of the subject. When the subject you are aiming at is small, or when you want to focus on a particular area of the subject, you can restrict the area that is focused on by making the AF frame smaller.

### 1 Press the button.

### 2 Press the button.

- Each time you press the **DISPLAY** button, the AF frame settings will switch between normal and small.
- When the camera has difficulty focusing on the subject when you press the shutter button halfway, the AF frame will display in orange (when AF frame is set to small).
- Pressing the  button completes the setting.

- When you set the AF frame to small in AiAF mode, the LCD monitor display will appear as shown right.

Examples: When [AiAF] is selected

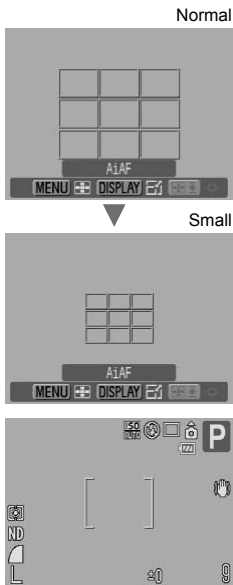





The AF frame size is set to normal when the digital zoom, digital tele-converter or manual focus is used.

## Moving the AF Frame ([AiAF] or [FlexiZone] Selected)

The AF frame can be moved manually allowing you to focus precisely on the desired area of your subject.

**1** Press the  button.

**2** Move the AF frame using the control dial and press the  button.

- You can move the AF frame to the position you wish to set using the , ,  or  button.
- The AF frame will move back to its original position (center), if you hold down the  button.



- You can move the AF frame when [AiAF] is selected as the metering mode and the AF frame is set to small.
- When the [Spot AE Point] is selected as the metering mode, you can use the selected Spot AE Point as the AF frame (p. 136).
- Selection cannot be made while in the manual focus mode (p. 124).
- The position of the AF frame returns to the center once the power is turned off.

## Shooting Hard-to-Focus Subjects (Focus Lock, AF Lock, Manual Focus, Safety MF)



➔ See *Functions Available in Each Shooting Mode* (p. 270).

Shooting Mode **AUTO** **SCN**\* **P** **Tv** **Av** **M**

\* Cannot be used in mode.

It may be difficult to focus on the following types of subjects.

- Subjects with extremely low contrast to the surroundings
- Scenes with a mixture of near and far subjects
- Subjects with extremely bright objects at the center of the composition
- Subjects that are moving quickly
- Subjects through glass: Try to shoot as close to the glass as possible to reduce the chances of light reflecting back off the glass.

### Shooting with the Focus Lock

- 1 Aim the camera so that an object at the same focal distance as the main subject is centered in the viewfinder or in the AF frame displayed on the LCD monitor.**
- 2 Press the shutter button halfway to lock the focus.**
- 3 Keep the shutter button pressed while you recompose the image and press the shutter button all the way to shoot the image.**

### Shooting with the AF Lock

- 1 Turn on the LCD monitor.**

**2** Aim the camera so that an object at the same focal distance as the main subject is centered in the AF frame.

**3** Press the shutter button halfway and press the MF button.





-  and the MF indicator display allowing you to confirm the distance to the subject.

**4** Re-aim the camera to compose the shot as desired and shoot.

#### To Release the AF Lock:

Press the MF button.



- The AF lock cannot be used in the **AUTO**,  and  modes. However, if you register the AF lock in [Set Shortcut button], you can use the AF lock in the  mode (p. 153).
-  or  mode does not display the AF frame.
- When shooting with the focus lock or AF lock using the LCD monitor, setting the [AF Frame] to [Center] (p. 116) makes shooting easier since the camera focuses using the center AF frame only.
- The AF lock is convenient because you can let go of the shutter button to compose the image. Moreover, the AF lock is still effective after the picture is taken, allowing you to capture a second image with the same focus.

## Shooting in Manual Focus Mode



The focus can be manually set.



**1** Turn on the LCD monitor.

## 2 Press the MF button to display MF.

- The MF indicator is displayed.
- When the  menu's [MF-Point Zoom] is set to [On], the portion of the image in the AF frame will appear magnified\*. When the AF mode (p. 115) is set to [Continuous], turning the Control Wheel will display the portion magnified. The magnified position will differ depending on the AF Frame Mode (p. 116) setting.



- When set to [Face Detect], [AiAF] or [Center], the center of the LCD monitor is magnified.
  - When set to [FlexiZone], the location of the AF frame displayed immediately prior to setting the manual focus will display magnified.
- \* When using , digital zoom, Digital Tele-Converter or while displaying the image on a TV, the display magnification is not available.
- \* Can also be set so that the image displayed is not magnified (p. 49).
- Depending on the shooting mode, pressing the  button will switch between the setting items as follows:

<b>SCN</b>	SCN mode/Exposure compensation*/ <b>MF</b>
	 mode/Exposure shift/ <b>MF</b>
<b>P</b>	Exposure compensation/ <b>MF</b>
<b>Tv</b>	Shutter speed/Exposure compensation/ <b>MF</b>
<b>Av</b>	Aperture value/Exposure compensation/ <b>MF</b>
<b>M</b>	Shutter speed/Aperture value/ <b>MF</b>

\* Cannot be set in ,  or  mode.



## 3 Use the control dial and adjust the focus.

- The MF indicator shows approximate figures. Use them as a shooting guideline only.

### To Cancel the Manual Focus:

Press the **MF** button.



The manual focus cannot be used in the **AUTO**,  and  modes.

## Using the Manual Focus in Combination with the Auto Focus

First, manual focus is used to roughly focus, then from that focus position the camera automatically focuses more accurately. You can use two methods.





### ■ Setting by the Button

#### 1 Focus the camera with the manual focus, then press the button.

- The camera focuses to a more accurate focusing point.



### ■ Setting the Safety MF

#### 1 Select [Safety MF].

1. Press the  button.
2. Use the  or  button to select [Safety MF] in the  menu.



#### 2 Make settings.

1. Use the  or  button to select [On].
2. Press the  button.



#### 3 Focus the camera with the manual focus, then press the shutter button halfway.

- The camera focuses to a more accurate focusing point.



## 4 To shoot, press the shutter button all the way down (press fully).



This cannot be used in the **AUTO**,  and  modes.

## Focus Bracketing (Focus-BKT Mode)

 See *Functions Available in Each Shooting Mode* (p. 270).

Shooting Mode **AUTO** **SCN**   **P** **Tv** **Av** **M**









The camera automatically takes three shots: one at the manual focus position, and one each with focus positions preset farther and nearer. The three shots are taken at the same interval as continuous shooting (p. 111).

The farther and nearer focus positions can be set in three steps: large, medium and small.



The Focus-BKT mode is not available when shooting with the flash on. Only one image at the manual focus position will be taken.

## 1 Select the Focus-BKT.

1. Press the  button.
2. Use the  or  button to select  and use the  or  button to select .
3. Press the  button.



## 2 Make settings.

1. Set the amount of focus position offset with the ◀ or ▶ button.
2. Press the  button.
  - Press the ▶ button to broaden or the ◀ button to narrow the focusing distance from the center.

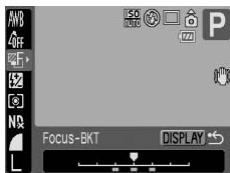

## 3 Shoot the image with manual focus (p. 124).

### To Cancel the Focus-BKT Mode:

Select  (BKT-Off) in Step 1.

## \* Locking the Exposure Setting (AE Lock)

 See *Functions Available in Each Shooting Mode* (p. 270).

Shooting Mode **AUTO** **SCN**   **P** **Tv** **Av** **M**

You can set the exposure and focus separately. This is effective when the contrast is too strong between the subject and background or when a subject is backlit.



Be sure to set the flash to  so that the flash does not fire. When the flash fires, the FE lock will be used (p. 130).

## 1 Turn on the LCD monitor.

## 2 Focus on the part of the subject on which you wish to lock the exposure setting.

## 3 Press the shutter button halfway.

## 4 Press the \* button.

- The exposure is fixed.

## 5 Re-aim the camera to compose the shot as desired.

### To Release the AE Lock:

Operate a button other than the **\***  button, the control dial and the ISO Speed dial.



After locking the AE, you can change the ISO speed with exposure fixed.

## Changing Shutter Speed and Aperture Value Combinations

Automatically selected combinations of shutter speeds and aperture values can be freely changed without altering the exposure (Program Shift).

**1 Focus on the subject on which you wish to lock the exposure.**

**2 Press the shutter button halfway.**

**3 Press the **\***  button.**

- Exposure is fixed.



Tv bar

Av bar

**4 Use the control dial to change shutter speed and aperture value combinations.**

**5 Recompose the image and shoot.**



- The setting will cancel after the shot is taken.

## \* Shooting with FE Lock

 See *Functions Available in Each Shooting Mode* (p. 270).

Shooting Mode **AUTO** **SCN**   **P** **Tv** **Av** **M**

You can lock the flash exposure so that the exposure settings are correctly set regardless of the composition of your subject.

- 1 Turn on the LCD monitor.**
- 2 Press the  button and set it to  (flash on).**
  - If you are using an externally mounted flash, please refer to its manual for setting instructions.
- 3 Focus the camera on the subject on which you wish to lock the exposure setting.**
- 4 Press the shutter button halfway.**
- 5 Press the \* button.**
  - The flash fires a pre-flash and the exposure is fixed.
- 6 Re-aim the camera to compose the shot as desired and press the shutter button fully.**

### To Release the FE Lock:

Operate a button other than the \* button or the control dial.



The FE lock function is not available when [Flash Mode] is set to [Manual].









## Auto Exposure Bracketing (AEB Mode)

 See *Functions Available in Each Shooting Mode* (p. 270).

Shooting Mode **AUTO** **SCN**   **P** **Tv** **Av** **M**



In this mode, the camera automatically changes the exposure within a set range to take three shots as the same interval as continuous shooting (p. 111). The images are shot in the following order: Standard exposure, underexposure and overexposure.

### 1 Select AEB.

1. Press the  button.
2. Use the  or  button to select  and use the  or  button to select .
3. Press the  button.



### 2 Adjust the compensation range.

1. Adjust the compensation range with the  or  button.
2. Press the  button.
  - The compensation range can be adjusted in 1/3 increments from -2 to +2 with the exposure at the time of shooting at the center. If exposure adjustment (p. 135) is already done, setting can be done with the adjusted value as the center point.



### To Cancel the AEB Mode:

Select  in Step 1.



The AEB mode cannot be used for flash photography. Only one standard exposure image gets recorded.

## Using the ND Filter



➔ See *Functions Available in Each Shooting Mode* (p. 270).

Shooting Mode **AUTO** **SCN** **P** **Tv** **Av** **M**

The ND filter reduces light intensity to 1/8 (3 stops) of the actual level, allowing for slower shutter speeds and smaller aperture values.



Always use a tripod to prevent camera shake in this mode.

# 1

### Select **ND**.

1. Press the button.
2. Use the or button to select **ND** and use the or button to select **ND**.
3. Press the button.



### To Cancel the ND Filter:

Select **ND**.

## Reducing the Effects of Camera Shake (Auto ISO Shift)



➔ See *Functions Available in Each Shooting Mode* (p. 270).

Shooting Mode **AUTO** SCN **P** Tv Av M

When the camera shake warning icon () appears while shooting, you can raise the ISO speed and shoot at a shutter speed that minimizes camera shake.

Off	Function is not available.
button	Allows you to check the ISO speed setting in the LCD monitor before and after the change.
On	Automatically sets the optimal ISO speed to compensate for camera shake.



- Does not function when the flash fires in **ISO HI**, **ISO 800** or **ISO 1600** mode.
- Depending on the shooting conditions, the camera shake warning icon () may not disappear even after the ISO speed is raised.

### 1 Select [Auto ISO Shift].

1. Press the button.
2. Use the or button to select [Auto ISO Shift] in the menu.



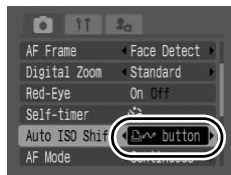

### 2 Make settings.

1. Use the or button to select [ button], [On] or [Off].
2. Press the button.





## ■ When [ ] button] is Selected

### 3 Press the shutter button halfway.

- The  appears and the  button will light blue.



### 4 Press the button while still pressing the shutter button halfway.

- The post-change ISO speed will display.
- When you press the  button again while the shutter button is still pressed halfway, the ISO speed returns to its original setting.
- If you set the AE Lock (p. 128) after raising the ISO speed, the ISO speed will not return to the previous setting, even if you release the shutter button. At this time, the  button lights blue.



### 5 Press the shutter button fully.

## ■ When [On] is Selected

### 3 Press the shutter button halfway.

- The camera selects the optimal speed according to light levels to compensate for camera shake.



### 4 Press the shutter button fully to shoot.



## Adjusting the Exposure Compensation

 See *Functions Available in Each Shooting Mode* (p. 270).

Shooting Mode **AUTO** **SCN\***   **P** **Tv** **Av** **M**

\* Cannot be set in ,  and  modes.

Adjust the exposure compensation to a positive value to avoid making the subject too dark when it is backlit or shot against a bright background. Adjust the exposure compensation to a negative value to avoid making the subject too bright in night shots or when shot against a dark background.

### 1 Turn on the LCD monitor.

### 2 Press the button several times until the exposure compensation bar is displayed.

### 3 Adjust.

1. Use the control dial to adjust the exposure compensation.
2. Press the  button.



- Depending on the shooting mode, pressing the  button will switch between the setting items as follows:

<b>SCN</b>	SCN mode/Exposure compensation
	Shooting direction selection/Exposure compensation
<b>Tv</b>	Shutter speed/Exposure compensation
<b>Av</b>	Aperture value/Exposure compensation



### To Cancel the Exposure Compensation:

Follow Step 3 to restore the compensation value to [0].







## Switching between Metering Modes

 See *Functions Available in Each Shooting Mode* (p. 270).

Shooting Mode **AUTO** **SCN**   **P** **Tv** **Av** **M**

	Evaluative	Appropriate for standard shooting conditions, including backlit scenes. The camera divides images into several zones for metering. It evaluates complex lighting conditions, such as the position of the subject, the brightness, the direct light, and the backlighting, and adjusts the settings to the correct exposure for the main subject.
	Center Weighted Average	Averages the light metered from the entire frame, but gives greater weight to the subject matter at the center.
	Spot AE Point	Meters the area within the spot AE point frame.
	Center	Locks the spot metering frame to the center of the LCD monitor.
	AF Point	Move the spot AE point to the same position as the selected AF frame. Can be set only in [FlexiZone] (p. 116).





### 1 Change a metering mode.

1. Press the  button.
2. Use the  or  button to select  and use the  or  button to change a metering mode.
3. Press the  button.





## Moving the Spot AE Point to the AF Frame/ Centering the Spot AE Point

### 1 Select [Spot AE Point].

1. Press the  button.
2. Use the  or  button to select [Spot AE Point] in the  menu.



### 2 Make settings.

1. Use the  or  button to select [Center] or [AF Point].
2. Press the  button.
  - When [Spot AE Point] is set to [Center], the spot AE point frame appears at the center of the LCD monitor.
  - When [AF Point] is set, it appears inside the selected AF frame.

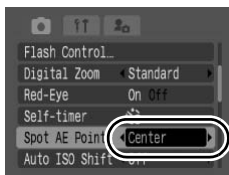





## Adjusting the Tone (White Balance)









 See *Functions Available in Each Shooting Mode* (p. 270).

Shooting Mode **AUTO** **SCN**   **P** **Tv** **Av** **M**







\* Cannot be set in  and  modes.

Normally, the  (Auto) white balance setting selects an optimal white balance. When the  setting cannot produce natural looking colors, change the white balance using a setting appropriate for the light source.



	Auto	Settings are automatically set by the camera.
	Day Light	For recording outdoors on a bright day.

	Cloudy	For recording under overcast, shady or twilight skies.
	Tungsten	For recording under tungsten and bulb-type 3-wavelength fluorescent lighting.
	Fluorescent	For recording under warm-white, cool-white or warm-white (3-wavelength) fluorescent lighting.
	Fluorescent H	For recording under daylight fluorescent, or daylight fluorescent-type 3-wavelength fluorescent lighting.
	Flash	When using the flash (  cannot be set in mode).
	Underwater	Appropriate for shooting images with the Waterproof Case WP-DC21 (sold separately). This mode yields image data in the optimal white balance to record images with natural hues by reducing the bluish tone.
	Custom	For recording with the optimal white balance data retained in the camera from a white-colored object, such as white paper or cloth.

## 1 Select a white balance setting.



1. Press the  button.
2. Use the  or  button to select  and use the  or  button to change a white balance setting.
3. Press the  button.



The white balance setting cannot be adjusted when  or  is selected for My Colors.









## Using the Custom White Balance

You can set a custom white balance to obtain the optimal setting for the shooting conditions by having the camera evaluate an object, such as a piece of white paper or cloth, or a photo-quality gray card that you wish to establish as the standard white color.

In particular, take a  (Custom 1) or  (Custom 2) white balance reading for the following situations that are difficult for the  (Auto) setting to detect correctly.

- Shooting close-ups (Macro)
- Shooting subjects of monotone color (such as sky, sea or forest)
- Shooting with a particular source of light (such as a mercury-vapor lamp)

### 1 Select or .

1. Press the  button.
2. Use the  or  button to select  and use the  or  button to select  or .



### 2 Aim the camera at a piece of white paper or cloth and press the button.

- If you are viewing it with the LCD monitor, ensure that the center frame is completely filled with the white image. If you are using the optical viewfinder, ensure that the entire field is filled. However, the center frame will not appear when using the digital zoom is 7.4x or higher or when  is displayed.



### 3 Press the button.



- You are recommended to set the shooting mode to **P** and the exposure compensation setting to  $[\pm 0]$  before setting a custom white balance. The correct white balance may not be obtained when the exposure setting is incorrect (image appears completely black or white).
- Shoot with the same settings as when reading the white balance data. If the settings differ, the optimal white balance may not be set. In particular, the following should not be changed.
  - ISO Speed
  - Flash: Setting the flash to on or off is recommended. If the flash fires when reading the white balance data with the flash set to Auto, make sure that you also use the flash when you shoot.
- Since the white balance data cannot be read in Stitch Assist mode, preset the white balance in another shooting mode beforehand.
- The white balance data is retained even after the camera power is turned off.





## Shooting in a My Colors Mode







 See *Functions Available in Each Shooting Mode* (p. 270).

Shooting Mode **AUTO** **SCN**    **P** **Tv** **Av** **M**

\* Cannot be set in  and  modes.

You can change the look of an image when it is shot.







	My Colors Off	Records normally.
	Vivid	Emphasizes the contrast and color saturation to record bold colors.
	Neutral	Tones down the contrast and color saturation to record neutral hues.
	Sepia	Records in sepia tones.
	B/W	Records in black and white.

	Positive Film	Use this option to make blue, green or red colors more intense like the Vivid Blue, Vivid Green or Vivid Red effects. It can produce intense natural-appearing colors like those obtained with positive film.
	Lighter Skin*	Use this option to make skin tones lighter.
	Darker Skin*	Use this option to make skin tones darker.
	Vivid Blue	Emphasize blue tints. Use to make blue subjects, such as the sky or ocean, more vivid.
	Vivid Green	Emphasize green tints. Use to make green subjects, such as mountains, new growth, flowers and lawns, more vivid.
	Vivid Red	Emphasize red tints. Use to make red subjects, such as flowers or cars, more vivid.
	Custom	Use this option to adjust the balance between contrast, sharpness, saturation, reds, greens, blues and skin tones*. It can be used to make subtle adjustments, such as making blue colors more vivid or face colors brighter.

\* If the image contains colors that are the same as human skin, those colors will also be changed. You may not obtain the expected results depending on the skin color.

## Setting the My Colors Mode (Modes other than )

### 1 Set the My Colors mode.

1. Press the  button.
2. Use the  or  button to select  and use the  or  button to select the My Colors mode.
3. Press the  button.

- The display will return to the shooting screen and you can shoot.



## Setting the My Colors Mode (My Colors Mode)

### 1 Select My Colors Mode.

1. Press the **FUNC SET** button.
2. Use the **↑** or **↓** button to select **OFF** and use the **←** or **→** button to select **My Colors**.



### 2 Adjust.

1. Press the **DISPLAY** button.
2. Use the **↑** or **↓** button to select [Contrast], [Sharpness], [Saturation], [Red], [Green], [Blue] or [Skin Tone].
3. Use the **←** or **→** button to adjust it.
  - The altered color will display.
  - If you press the **DISPLAY** button at this point, you will return to the screen where you can select a My Colors mode.
4. Press the **FUNC SET** button.
  - This completes the setting.



Select an item      Adjust







## Changing the Colors and Shooting

 See *Functions Available in Each Shooting Mode* (p. 270).

Shooting Mode **SCN**()'()

You can easily change the colors in an image when it is shot both stills and movies, allowing you to enjoy producing various effects. Depending on the shooting conditions, however, the images may appear rough, or you may not get the expected color. Before photographing important subjects, we recommend taking trial shots and checking the results. By setting the [Save Original] function (p. 147) to [On] when shooting stills, you can also record both the altered image and the original, unaltered image.

 	Color Accent	Use this option to have only the color specified in the LCD monitor remain and to transform all others to black and white.
 	Color Swap	Use this option to transform a color specified in the LCD monitor into another. The specified color can only be swapped into one other color, and multiple colors cannot be chosen.



Depending on the scene being shot, the ISO speed may increase, increasing the amount of noise in the image.



## Shooting with Color Accent Mode

### 1 Select or .

**Still image:**

1. Set the mode dial to **SCN**.
2. Use the control dial to select .

**Movie:**

1. Set the mode dial to .
2. Use the control dial to select .

Still image:



Movie:

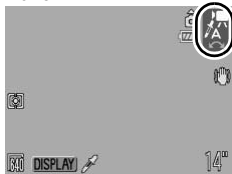



### 2 Press the button.

- The camera will switch to color input mode, and the display will alternate between the original image and the Color Accent image (using the previously set color).



### 3 Aim the camera so that the color you wish to retain appears at the center of the LCD monitor and press the button.

- Only one color can be specified.
- You can use the  or  button or the control dial to specify the range of the colors that are retained.
  - 5: Only takes the color that you want to retain.
  - +5: Also takes colors close to the one that you want to retain.

### 4 Press the button to complete the setting, then shoot.



- The default Color Accent is green.
- You may not obtain the expected results after color input mode if you use the flash.
- The specified Color Accent is retained even if the camera's power is turned off.

## Shooting with Color Swap Mode

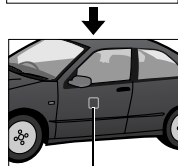

Original Color  
(Before Swapping)

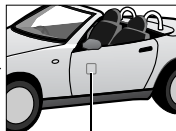

Desired Color  
(After Swapping)

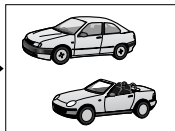



### 1 Select or .

#### Still image:

1. Set the mode dial to **SCN**.
2. Use the control dial to select .

#### Movie:

1. Set the mode dial to .
2. Use the control dial to select .

#### Still image:



#### Movie:





## 2 Press the button.

- The camera will switch to color input mode, and the display will alternate between the original image and the color swap image (using the previously set color).



## 3 Aim the camera so that the original color appears at the center of the LCD monitor and press the button.

- Only one color can be specified.
- You can use the  or  button or the control dial to specify the range of colors that are changed.
  - 5: Only takes the color that you want to swap.
  - +5: Also takes colors close to the one that you want to swap.

## 4 Aim the camera so that the desired color appears at the center of the LCD monitor and press the button.

- Only one color can be specified.

## 5 Press the button to complete the setting, then shoot.



- The default setting for Color Swap changes green into white.
- You may not obtain the expected results after color input mode if you use the flash.
- The colors specified in the Color Swap mode are retained even if the camera's power is turned off.

## Saving Original Images



Not only can you save images with altered colors when shooting still images with the Color Accent or Color Swap modes, but you can also choose to save the original images (before the color change).

### 1 Select [Save Original].

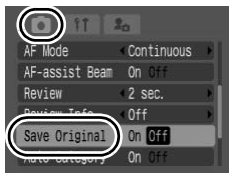
1. Press the  button.
2. Use the  or  button to select [Save Original] in the  menu.



### 2 Make settings.

1. Use the  or  button to select [On] or [Off].
2. Press the  button.

- If [On] is selected, the images will be saved as consecutive file numbers. The original image will be the lower file number, while the image shot in Color Accent or Color Swap mode will be the higher file number.



#### If [Save Original] is set to [On]

- Only the image set with Color Accent or Color Swap is displayed on the LCD monitor during shooting.
- The image displayed on the LCD monitor immediately after shooting is the one shot with Color Accent or Color Swap. As erasing the image at this time will cause the original image to be erased at the same time, be careful.
- As two images are saved with each shot, the number of recordable shots displayed on the LCD monitor will be half the number that is displayed when [Save Original] is set to [Off].

## Switching between Flash Adjustment Settings

 See *Functions Available in Each Shooting Mode* (p. 270).

Shooting Mode **AUTO** SCN   **P\*** Tv Av M

\* [Manual] can be selected only when an externally mounted flash has been attached.





Although the built-in flash and an externally mounted flash (Speedlite 220EX/430EX/580EX II/ST-E2 Speedlite Transmitter) will fire with automatic flash adjustments, it is also possible to set them so that it fires without any adjustments.

### 1 Display the Flash Settings screen.

1. Hold the  button down for more than one second.



### 2 Make settings.

1. Use the  or  button to select [Flash Mode] and use the  or  button to select [Auto] or [Manual].
2. Press the  button.



You can also set in [Flash Control] in the  menu.

## Compensating the Flash Adjustment

 See *Functions Available in Each Shooting Mode* (p. 270).

Shooting Mode **AUTO** **SCN**   **P** **Tv** **Av** **M**







Flash exposure compensation can be adjusted in the range of -2 to +2 stops in 1/3-stop increments\*.

You can combine the flash exposure compensation with the camera's exposure compensation function for balanced exposure of the background when shooting with a flash.



In **Tv** and **Av** shooting modes, set [Flash Mode] to [Auto] (p. 148).

\* Externally mounted flash: The range of -3 to +3

### 1 Adjust the flash exposure compensation.

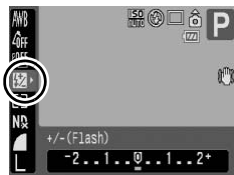
1. Press the  button.
2. Use the  or  button to select  and use the  or  button to adjust the flash exposure compensation.
3. Press the  button.



- You can change the settings holding the  button down for more than one second. You can also set in [Flash Control] ► [Flash Exp. Comp] in the  menu (p. 48).



Be sure the external flash is turned on before making settings for the flash.

## Setting the Flash Output



➔ See *Functions Available in Each Shooting Mode* (p. 270).

Shooting Mode **AUTO** **SCN** **P** **Tv** **Av** **M**

The flash output can be controlled in three steps, starting from FULL, when shooting. When an externally mounted flash is attached, its flash output can be controlled (From 1/1 (full power) to 1/64\* in 1/3 steps). In **Tv** and **Av** shooting modes, please set [Flash Mode] to [Manual] (p. 148).

\* Speedlite 580EX II: 1/128

### 1 Set the flash output.

1. Press the button.
2. Use the or button to select and use the or button to change the flash output.
3. Press the button.

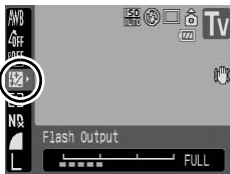

- You can change the settings holding the button down for more than one second. You can also set in [Flash Control] ▶ [Flash Output] in the menu (p. 48).



Be sure the external flash is turned on before making settings for the flash.



## Switching the Timing at which the Flash Fires

 See *Functions Available in Each Shooting Mode* (p. 270).

Shooting Mode **AUTO** **SCN**   **P** **Tv** **Av** **M**

1st-curtain	The flash fires right after the shutter opens, regardless of the shutter speed. Usually, the 1st-curtain is used when shooting.
2nd-curtain	The flash fires right before the shutter closes. Compared with the 1st-curtain, the flash fires later and allows you to shoot images in which, for example, a car's taillights seem to trail off behind.

### 1 Display the Flash Settings screen.

1. Hold the  button down for more than one second.

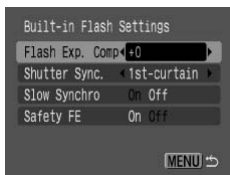

### 2 Make settings.





1. Use the  or  button to select [Shutter Sync.] and use the  or  button to select [1st-curtain] or [2nd-curtain].
2. Press the  button.



Image shot with the 1st-curtain setting



Image shot with the 2nd-curtain setting



You can also set in [Flash Control] in the  menu.

## Adjusting Exposure for Built-in Flash Shooting (Safety FE)

 See *Functions Available in Each Shooting Mode* (p. 270).

Shooting Mode **AUTO** **SCN**   **P** **Tv** **Av** **M**



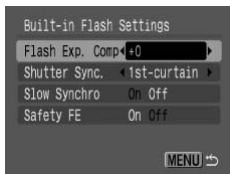

The camera automatically changes the shutter speed or aperture value when the flash fires to avoid overexposing and blowing out the highlights in the scene. In **Tv** and **Av** shooting modes, ensure that the flash adjustment setting is configured to [Auto] in advance (p. 148).

### 1 Display the Flash Settings screen.

1. Hold the  button down for more than one second.



### 2 Make settings.

1. Use the  or  button to select [Safety FE] and use the  or  button to select [On] or [Off].
2. Press the  button.













You can also set in [Flash Control] in the  menu.

## Registering Settings to the Shortcut Button





 See *Functions Available in Each Shooting Mode* (p. 270).

Shooting Mode **AUTO** **SCN**   **P** **Tv** **Av** **M**

One frequently used function can be registered to the  (Shortcut) button. You can register the following functions.

Menu Item	Page	Menu Item	Page
 Not Assigned	–	 Digital Tele-converter	p. 73
 Light Metering	p. 136	 AF Lock	p. 123
 ND Filter	p. 132	 Display Off	p. 52
 White Balance	p. 137		
  Manual WB1, WB2 (White Balance)	p. 139		

### 1 Select [Set Shortcut button].



1. Press the  button.
2. Use the  or  button to select [Set Shortcut button] in the  menu.
3. Press the  button.

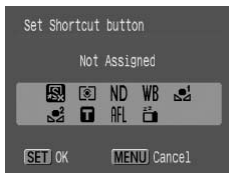

## 2 Make settings.

1. Use the **↑**, **↓**, **←** or **→** button to select the function you wish to register.
2. Press the  button.









- If  appears on the lower right of the icon, you can still register this function but pressing the  button will not activate the function in the current shooting mode.
- Pressing the **MENU** button completes the setting.

### To Cancel the Shortcut Button:

Select  in Step 2.

## Using the Shortcut Button

### 1 Press the button.

- Each press of the  button cycles between setting values of the registered function.
  - For , **ND** and **WB**, the setting screen appears.
  - For  and , a white balance reading is taken when you press the  button. A frame will not be displayed, so center the piece of white paper or cloth in the LCD monitor before pressing the  button.
  - For **AFL**, pressing the  button sets AE lock.

## Setting the Auto Rotate Function



➔ See *Functions Available in Each Shooting Mode* (p. 270).

Shooting Mode **AUTO** SCN P Tv Av M

Your camera is equipped with an Intelligent Orientation sensor that detects the orientation of an image shot with the camera held vertically and automatically rotates it to the correct orientation when viewing it in the LCD monitor.

### 1 Select [Auto Rotate].

1. Press the button.
2. Use the or button to select the menu.
3. Use the or button to select [Auto Rotate].



### 2 Make settings.

1. Use the or button to select [On] or [Off].
  2. Press the button.
- When the Auto Rotate function is set to [On] and the LCD monitor is set to the detailed display mode during shooting, (normal), (right end is down) or (left end is down) will appear in the display.

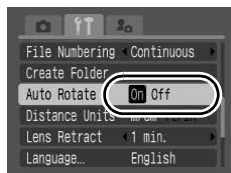

- This function may not operate correctly when the camera is pointed straight up or down. Check that the icon () is pointing in the right direction and if it is not, then set the Auto Rotate function to [Off].
- Even if the Auto Rotate function is set to [On], the orientation of images downloaded to a computer will depend upon the software used to download the images.



When the camera is held vertically to shoot, the Intelligent Orientation sensor judges the upper end to be “up” and the lower end to be “down”. It then regulates the optimal white balance, exposure and focus for vertical photography. This function operates regardless of the on/off status of the Auto Rotate function.

## Creating an Image Destination (Folder)

 See *Functions Available in Each Shooting Mode* (p. 270).







Shooting Mode **AUTO** **SCN**   **P** **Tv** **Av** **M**

You can create a new folder at any time and the recorded images will be automatically saved to that folder.

Create New Folder	Creates a new folder the next time you shoot images. To create an additional folder, insert the check mark again.
Auto Create	You can also specify a date and time if you wish to create a new folder using a shooting time after the specified date and time.



## Creating a Folder the Next Time You Shoot

### 1 Select [Create Folder].

1. Press the  button.
2. Use the  or  button to select the  menu.
3. Use the  or  button to select [Create Folder].
4. Press the  button.



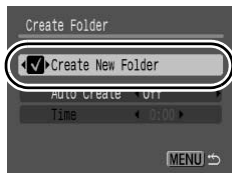

## 2 Make settings.

1. Use the ◀ or ▶ button to check mark [Create New Folder].
2. Press the  button.
  -  displays in the LCD monitor. The symbol will cease to display after the new folder is created.





## Setting the Day or Time for Automatic Folder Creation

### 1 Select [Create Folder].

1. Press the  button.
2. Use the ◀ or ▶ button to select the  menu.
3. Use the ▲ or ▼ button to select [Create Folder].
4. Press the  button.



### 2 Make settings.

1. Use the ▲ or ▼ button to select [Auto Create] option and use the ◀ or ▶ button to select a day.
2. Use the ▲ or ▼ button to select [Time] option and use the ◀ or ▶ button to set a time.
3. Press the  button.
  -  displays in the LCD monitor when the specified time arrives. The symbol will cease to display after the new folder is created.

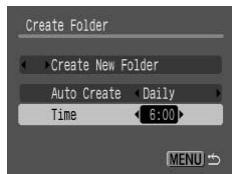



Up to 2000 images can be saved into one folder. A new folder will automatically be created when you record more than that number even if you are not creating new folders.

## Resetting the File Number



➔ See *Functions Available in Each Shooting Mode* (p. 270).

Shooting Mode **AUTO** SCN **P** Tv Av M

The images you shoot are automatically assigned file numbers. You can select how the file number is assigned.

Continuous	<p>A number one higher than the last one recorded is assigned to the next image. This is convenient for managing all your images together on a computer because you avoid file name duplication when changing folders or memory cards*.</p> <p>* When a blank memory card is used. If a memory card with recorded data is used, the 7-digit number for the last recorded folder and image is compared with the last one on the card, and the larger of the two is utilized as the basis for new images.</p>
Auto Reset	<p>The image and folder number are reset to the starting value (100-0001)*.</p> <p>This is convenient for managing images on a folder-by-folder basis.</p> <p>* When a blank memory card is used. If a memory card with recorded data is used, the number following the 7-digit number for the last recorded folder and image on the card is utilized as the basis for new images.</p>

### 1 Select [File Numbering].

1. Press the button.
2. Use the or button to select the menu.
3. Use the or button to select [File Numbering].

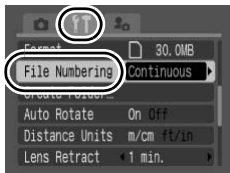



## 2 Make settings.

1. Use the  $\leftarrow$  or  $\rightarrow$  button to select [Continuous] or [Auto Reset].
2. Press the  button.

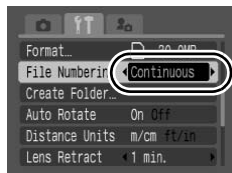

## File and Folder Numbers

Recorded images are assigned consecutive file numbers starting with 0001 and ranging up to 9999, while folders are assigned numbers starting with 100 and ranging up to 999.

Up to 2000 images can be saved into a single folder.

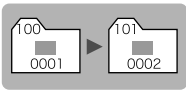
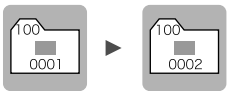
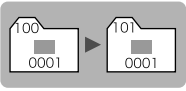
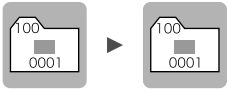
	New Folder Created	Memory Card Exchanged for Another
Continuous	Memory Card 1 	Memory Card 1 Memory Card 2 
Auto Reset	Memory Card 1 	Memory Card 1 Memory Card 2 

- Images may be saved to a new folder when there is insufficient free space even if the total number of images in a folder is less than 2000 because the following types of images are always saved together into the same folder.
  - Images from continuous shooting
  - Self-timer images (custom)
  - Stitch Assist mode images
  - Focus Bracketing
  - AEB shooting
  - Color Accent/Color Swap still images (when [Save Original] is set to [On])
- Images cannot be played back when the folder numbers are duplicated or image numbers are duplicated within folders.
- Please refer to the *Software Starter Guide* for information regarding folder structures or image types.

## Playback/Erasing

### Q Viewing Magnified Images

In playback mode, you can select images with the control dial. Turning it counterclockwise selects the previous image while turning it clockwise selects the next image. Please also see *Viewing Still Images* (p. 19).

#### 1 Press the zoom lever toward .

- A magnified portion of the image will display.
- Images can be magnified up to a factor of approximately 10x.



Approximate location of the displayed area

#### 2 Use the , , or button to move around the image.

- If you use the control dial while in the magnified display mode, the camera will switch to the previous or next image at the same level of magnification.
- You can change the magnification level with the zoom lever.

#### To Cancel the Magnified Display:

Press the zoom lever toward . (You can also cancel it immediately by pressing the **MENU** button.)



Movie frames and index playback images cannot be magnified.

## ☒ Viewing Images in Sets of Nine (Index Playback)



### 1 Press the zoom lever toward ☒.

- Up to nine images can be viewed at once in index playback.
- Use the  $\uparrow$ ,  $\downarrow$ ,  $\leftarrow$  or  $\rightarrow$  button to change the image selection.

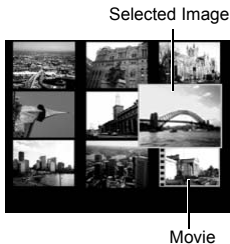

### To Return to Single Image Playback:

Press the zoom lever toward  $\mathcal{Q}$ .

### Switching between Sets of Nine Images

The jump bar will display if you press the  $\mathcal{H}$  button while in index playback and you can switch the display between sets of nine images.

- Pressing the zoom lever toward ☒ also switches the display. Use the  $\leftarrow$  or  $\rightarrow$  button to move to the previous or next set of 9 images.
- Hold the **FUNC./SET** button down and press the  $\leftarrow$  or  $\rightarrow$  button to jump to the first or last set.



### To Cancel the Jump Bar:

Press the  $\mathcal{H}$  button.

## Checking the Focus and Peoples' Expressions (Focus Check Display)

Focus Check display allows you to check the focus of images taken. At this time, faces in the image are detected and frames matching the size of these facial images are displayed. Moreover, as you can change the display magnification and switch images, you can easily check facial expressions and whether a subject's eyes are closed.

### Focus Check Display

**1** Press the  button.

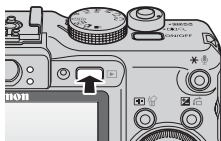

**2** Press the  button repeatedly until the focus check display appears.



- Frames are displayed as follows.

Frame Color	Summary
Orange	Displays the range of the image displayed at bottom right.
White	The frame is displayed at a position at which the image is in focus (AF Frame).
Gray	Displays frames in positions where faces were detected during playback (Face Frame).

- The orange frames allow you to change the display magnification, move the display position, and switch between display frames (p. 163).

## Changing the Display Magnification

### 3 Press the zoom lever toward .

- The bottom right of the screen is magnified.



## Switching between the Frames

### 3 Press the button.

- When multiple in-focus frames are displayed, or when multiple faces are detected, the position of the orange colored frame will change each time the **FUNC./SET** button is pressed. After you change the display magnification, the orange frame will adjust to the size of the face when you switch the position of the frame.



## Changing the Display Position

### 3 Press the zoom lever toward .

- The bottom right of the screen is magnified.



### 4 Use the **↑**, **↓**, **←** or **→** button to move the display position.

- When you press the **FUNC./SET** button, the orange frame returns to its original position. When there are multiple frames displayed, the **FUNC./SET** button switches between the different positions of the orange frames.









### To Cancel Changing the Display Position:

Press the **MENU** button.

## Jumping to Images

When you have many images recorded onto a memory card, it is handy to use the search keys below to jump over images to find the object of your search.

	Shot Date	Jumps to the first image of each shooting date.
	My Category	Displays the first image in each category.
	Folder	Displays the first image in each folder.
	Movie	Jumps to a movie.
	By 10 images	Jumps over 10 images at a time.
	By 100 images	Jumps over 100 images at a time.

### 1 In single image playback mode, press the button.

- The camera will switch to jump search mode.

### 2 Use the **↑** or **↓** button to select a search key.

- The screen sample will vary slightly according to the search key.
- You can show/hide image information using the **DISPLAY** button.





### 3 Display the Images.

-  /  / :

1. Press the  or  button.

- Press the **MENU** button to return to single image playback.

-  /  / :

1. Use the  or  button to select a date, category, folder or movie for playback.

- When you turn the Control Wheel, you can view the defined images.
- Press the **MENU** button to cancel the setting.

2. Press the  button.

- The camera will switch to defined playback mode and play back only images corresponding to the search key.
- Press the  button to cancel defined playback mode.

Select the search key



- Defined playback mode will be canceled under the following conditions:
  - Changing categories (while using My Category to define images).
  - When selecting a range of images.
  - When saving an image as a new file after processing or editing it.
  - When erasing an image with [Erase] in the  menu.



## Organizing Images by Category (My Category)



You can organize images into prepared categories (People, Scenery, Events, Category 1 – 3, To Do). Category information recorded with the [Auto Category] function (p. 49) can also be edited. At the category level, you can perform the following.

- Image searches (p. 165) • Slide Show (p. 176)
- Protect (p. 192) • Erase (p. 195) • Configure print settings (p. 198)

### Single Images



#### 1 Select [My Category].

1. Press the  button.
2. Use the  or  button to select  in the  menu.
3. Press the  button.

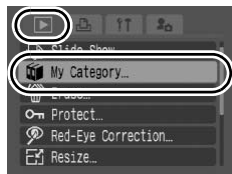
- In playback mode, you can press the   button to display the screen in Step 3 directly.





#### 2 Select [Select].

1. Use the  or  button to select [Select].
2. Press the  button.



### 3 Make settings.

1. Use the ◀ or ▶ button to select an image to classify.
2. Use the ▲ or ▼ button to select a category.
3. Press the  button.
4. Press the  button.



- You can put the same image into more than one category.
- You can set in index playback.
- You can cancel the classification by pressing the **FUNC./SET** button again.

## Selecting a Range of Images

You can select a range of sequential images and gather them together in a category. The file number of the last image should be larger than the number of the first image. Up to 500 images can be selected.

### 1 Select [My Category].

1. Press the  button.
2. Use the ▲ or ▼ button to select  in the  menu.
3. Press the  button.



### 2 Select [Select Range].

1. Use the ▲ or ▼ button to select [Select Range].
2. Press the  button.



### 3 Select a category.

1. Press the  $\uparrow$  or  $\downarrow$  button.
2. Use these  $\leftarrow$  or  $\rightarrow$  button to select a category.



### 4 Select images.

1. Use the  $\uparrow$  or  $\downarrow$  button to select a left image.

2. Press the  button.

3. Use the  $\leftarrow$  or  $\rightarrow$  button to select a first image.

4. Press the  button.

5. Use the  $\leftarrow$  or  $\rightarrow$  button to select a right image.



6. Press the  button.

7. Use the  $\leftarrow$  or  $\rightarrow$  button to select a last image.

8. Press the  button.



## 5 Make settings.

1. Use the **▲** or **▼** button to select [Select].
2. Press the  button.
3. Press the  button twice.
  - Selecting [Deselect] cancels categorization of the selected range.





When erasing, printing or compiling a slide show, it is convenient to categorize images in the [To Do] category.

## Viewing Movies (Operating the Movie Control Panel)



Movies cannot be played in the index playback mode.

## 1 Display a movie.

1. Use the **◀** or **▶** button to select a movie.
2. Press the  button.
  - Images with a  icon are movies.



## 2 Play.

1. Use the ◀ or ▶ button to select .

2. Press the  button.

- The movie will pause if you press the **FUNC./SET** button during playback. It will resume when you press the button again.
- When playback ends, the movie stops at the last frame displayed. Press the **FUNC./SET** button to display the movie control panel.
- You can switch between showing/hiding the playback progress bar by pressing the **DISPLAY** button while playing a movie.
- If playback was halted partway through in the prior viewing session, playback will resume from the last frame displayed.

Movie Control Panel











Playback Progress Bar

Time movie was shot \_\_\_\_\_

Volume Level (Adjust it with the ▲ or ▼ button)

## Operating the Movie Control Panel

	Returns to single image playback
	Print (An icon will display when a printer is connected. See the <i>Direct Print User Guide</i> for details.)
	Play
	Slow motion (You can use the ◀ button to slow down or the ▶ button to speed up playback.)
	Displays the first frame
	Previous frame (Rewinds if the <b>FUNC./SET</b> button is held down.)
	Next frame (Fast Forwards if the <b>FUNC./SET</b> button is held down.)
	Displays the last frame
	Edit (Switches to movie editing mode.) (p. 172)



- Use the television's controls to adjust the volume when playing a movie on a TV set (p. 205).
- The sound cannot be played in slow motion playback.

## Editing Movies



You can delete portions of recorded movies.



- The actual position of the edited movie may differ slightly from editing the results viewed on the LCD monitor.
- Movies 1 second or longer before editing can be edited in 1-second increments, but those that are protected or less than 1 second long ( 15 seconds\*<sup>1</sup> or 30 seconds\*<sup>2</sup>) cannot be edited.

\*1 [Interval Time]: 1 second

\*2 [Interval Time]: 2 seconds

### 1

#### Display a movie.

1. Use the or button to select a movie.
  2. Press the button.
- Images with a icon are movies.









### 2



#### Select (Edit).

1. Use the or button to select .
2. Press the button.



### 3 Edit.

1. Use the  or  button to select  (Cut Beginning) or  (Cut End).
2. Use the  or  button to specify the cut point ().







- To check a temporarily edited movie, select  (Play) and press the **FUNC./SET** button.
- Selecting  (Exit) cancels the edit and restores the movie control panel.

Movie Editing Panel



Movie Editing Bar

### 4 Save.

1. Use the  or  button to select .
2. Press the  button.
3. Use the  or  button to select [New File] or [Overwrite].
4. Press the  button.



- [New File] saves the edited movie under a new file name. The pre-edit data is left unchanged. Note, if you press the SET button while saving the movie, saving is cancelled.
- [Overwrite] saves the edited movie with its original name. The pre-edit data is lost.
- When there is not enough space left on the memory card, only [Overwrite] can be selected.



Depending on the movie's file size, it may take some time to save an edited movie. If the batteries run out partway through, edited movie clips cannot be saved. When editing movies, it is recommended to use fully charged batteries or the AC Adapter Kit ACK-DC20 (sold separately) (p. 234).

## Rotating Images in the Display



Images can be rotated clockwise 90° or 270° in the display.



Original

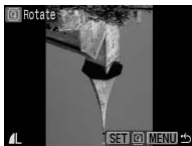

90°





270°

### 1 Select [Rotate].

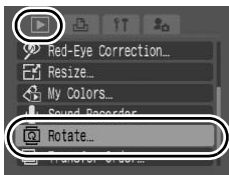
1. Press the  button.
2. Use the  or  button to select  in the  menu.
3. Press the  button.



### 2 Rotate.

1. Use the  or  button to select an image to rotate.
2. Press the  button.
  - Cycle through the 90°/270°/original orientations with each press of the **FUNC./SET** button.
  - This also can be set in the index playback mode.

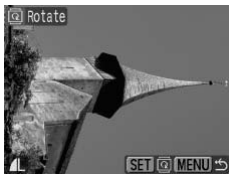





When images are downloaded to a computer, the orientation of images rotated by the camera will depend upon the software used to download the images.



## Playback with Transition Effects

You can select the transition effect displayed when switching between images.







	No transition effect.
	The displayed image darkens and the next image gradually brightens until it is displayed.
	Press the  button to have the previous image display from the left and the  button to have the next image display from the right.

### 1 Select [Transition].

1. Press the  button.
2. Use the  or  button to select  in the  menu.



### 2 Make settings.









1. Use the  or  button to select ,  or .
2. Press the  button.



## Automated Playback (Slide Shows)

Automated Playback of Memory Card Images.

\* Image settings for slide shows are based on the Digital Print Order Format (DPOF) standard (p. 198).







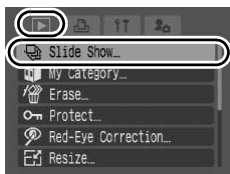













	All Images	Plays all images on a memory card in order.
	Date	Plays images bearing a specified date in order.
	My Category	Plays the images in the selected category in order.
	Folder	Plays images in a specified folder in order.
	Movies	Plays movie files only, in order.
	Stills	Plays still images only, in order.
 <b>1</b> to  <b>3</b>	Custom 1 – 3	Plays the images selected for each slide show, Custom 1, Custom 2 or Custom 3, in order (p. 179).

### 1 Select [Slide Shows].

1. Press the  button.
2. Use the  or  button to select  in the  menu.
3. Press the  button.



### 2 Select an image selection method.



1. Use the , ,  or  button to select , , , , ,  or  **1** –  **3**.
- , , : select a date, category or folder to play back (p. 178).
  - For  **1** –  **3**: select the images to be played back (p. 179).
  - If you want to add a transition effect to play back images, use the  button to select [Effect] and choose the type of effect with the  or  button (p. 177).



### 3 Play.

1. Use the , ,  or  button to select [Start].
2. Press the  button.





- The following functions are available during slide shows.

- Pausing/resuming the slide show: press the **FUNC./SET** button.
- Fast forwarding/rewinding the slide show: press the  or  button (continue to hold the button to switch between images more rapidly).
- Stopping the slide show: press the **MENU** button.



## Transition Effects

You can select the transition effect used when one image is replaced by another.

	No transition effect.
	The new image gradually brightens as it moves upward from the bottom.
	The new image first appears in a cross shape and gradually expands to display the full image.
	Portions of the new image move horizontally, then the image expands to display the full image.

\* Default setting.



In single image playback mode, you can start a slide show from the current image displayed by holding the **FUNC./SET** button while you press the  button. Please note that if you do this while the last image shot is displayed, the slide show will start from the first image using the same date.







## Select a Date/Category/Folder to Playback (//)

### 1 Select , or .

1. Use the , ,  or  button to select.
2. Press the  button.



### 2 Select a date/category/ folder to play back.

1. Use the  or  button to select.
2. Press the  button.
  - Pressing the **FUNC./SET** button again cancels the setting.
  - You can select multiple dates, categories, or folders.
  - They will play back in the order you select them.
  - Use the  or  button to confirm each date, category or folder image.
3. Press the  button.



## Selecting Images for Playback (\*1 - \*3)

Select only the images that you wish to play back and save them as a slide show (Custom 1, 2 or 3). Up to 998 images can be selected. They will be played back in their order of selection.

### 1 Select \*1, \*2 or \*3.

1. Use the  $\uparrow$  or  $\downarrow$  button to select \*1, \*2 or \*3.
2. Press the  button.

- Only the \*1 icon will display at first. When you set \*1, the icon will change to \*1V and \*2 will display. \*2 and \*3 will change in the same way when they are set.

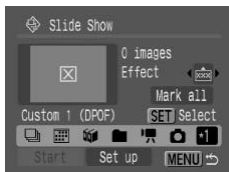

### 2 Select images for playback.

1. Use the  $\leftarrow$  or  $\rightarrow$  button to select images for playback.
2. Press the  button to select them.

- Pressing the **FUNC./SET** button again cancels the setting.
- You can also select images in the index playback mode.

3. Press the  button.

Check mark indicating selection

Number indicating the selection order



### Selecting All Images:

- 1 After selecting \*1 - \*3 in Step 1, use the  $\uparrow$  button to select [All Images] and press the **FUNC./SET** button.
  - 2 Use the  $\uparrow$  button to select [Mark all], press the **FUNC./SET** button.
  - 3 Use the  $\rightarrow$  button to select [OK] and press the **FUNC./SET** button.
- To deselect all images, select [Reset].

## Adjusting the Play Time and Repeat Settings

### Play Time

Sets the duration that each image displays. Choose between 3\*- 10 seconds, 15 seconds and 30 seconds. (Displaying time can vary slightly depending on the image.)

\* Default setting.

### Repeat

Sets whether the slide show stops when all the slides have been displayed or continues until stopped.

#### 1 Select [Set up].

1. Use the **↑**, **↓**, **←** or **→** button to select [Set up].
2. Press the  button.



#### 2 Make settings.

1. Use the **↑** or **↓** button to select [Play Time] or [Repeat].
2. Use the **←** or **→** button to select the desired option.
3. Press the  button.

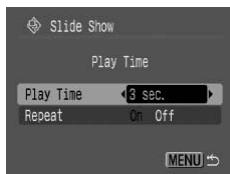

## Red-Eye Correction Function



You can correct red eyes in recorded images.



Red eyes may not be automatically detected in some images or the results may not turn out as you intended.

Examples:



- Faces near the screen edges or faces that appear extremely small, large, dark or bright in relation to the overall image.
- Faces turned to the side or at a diagonal, or faces with a portion hidden.

## 1 Select [Red-Eye Correction].



1. Press the  button.
2. Use the  or  button to select  in the  menu.
3. Press the  button.





## 2 Select a image.

1. Use the  or  button to select an image you wish to perform red-eye correction on.
2. Press the  button.



- A frame will be displayed automatically at the position where red-eye is to be corrected.
- If red-eye is not automatically detected, select [Add Frame] with the  or  button and press the **FUNC./SET** button (p. 183).
- If you want to delete the frame, select [Remove Frame] and press the **FUNC./SET** button (p. 184).

## 3 Correct.

1. Use the  or  button to select [Start].
2. Press the  button.



## 4 Save.

1. Use the ◀ or ▶ button to select [New File] or [Overwrite].

2. Press the  button.

- [New File]: saves the image under a new file name. The original file remains as is. The newly saved image file is saved as the last image of the photographed images.
- [Overwrite]: saves the new image under the original file name. The original image is overwritten.
- If you select [New File], proceed to Step 5.



## 5 Display the saved image.

1. Press the  button.

2. Use the ◀ or ▶ button to select [Yes].

3. Press the  button.

- If you select [No], the display will return to the Play menu.



- Red-eye correction cannot be performed on movies and RAW images. When shooting in [Record RAW + ], red-eye correction can be performed on the JPEG image, but the original image cannot be overwritten.
- Overwriting cannot be performed on protected images.



- When there is not enough space left on the memory card, red-eye correction cannot be performed.
- Although you can apply red-eye correction any number of times to an image, the image quality will gradually deteriorate with each application.
- Since the correction frame will not appear automatically on images that have already been corrected once with the [Red-Eye Correction], use the [Add Frame] option to correct them.



## Adding Correction Frames

### 1 Select [Add Frame].

1. Use the  $\leftarrow$  or  $\rightarrow$  button to select [Add Frame].
2. Press the  button.
  - The green frame is displayed.



### 2 Move the frame position.

1. Use the  $\uparrow$ ,  $\downarrow$ ,  $\leftarrow$  or  $\rightarrow$  button to move the frame.
- You can change the size of the frame with the zoom lever.



### 3 Add a frame.

1. Press the  button.
  - The correction frame will be added and the frame color will change to white.
  - Press the **FUNC./SET** button to add additional frames.
  - You can add up to a maximum of 35 correction frames.
  - Press the **MENU** button to cancel adding the frame.



To correctly perform red-eye correction, take note of the following (refer to the image in Step 2):

- Adjust the correction frame size so that it only surrounds the red-eye portion to be corrected.
- When there are several subjects with red-eye, be sure to add one correction frame per subject.

## Removing Correction Frames

### 1 Select [Remove Frame].

1. Use the ◀ or ▶ button to select [Remove Frame].
2. Press the  button.



### 2 Select a frame you wish to remove.

1. Use the ◀ or ▶ button to select a frame you wish to remove.
  - The selected frame will appear in green.



### 3 Remove the frame.

1. Press the  button.
  - The selected frame will be removed.
  - To continue removing other frames, repeat the procedures from Step 2 onward.
  - Press the **MENU** button to cancel removing the frame.

## Adding My Colors Effects



You can add effects to recorded images (stills only) using the My Colors function. The following selection of My Colors effects is available. For details, see p. 140.

Vivid	Lighter Skin Tone
Neutral	Darker Skin Tone
Sepia	Vivid Blue
B/W	Vivid Green
Positive Film	Vivid Red

### 1 Select [My Colors].

1. Press the button.

2. Use the or button to select in the menu.

3. Press the button.



### 2 Select an image.

1. Use the or button to select an image you wish to add effects.

2. Press the button.



### 3 Make settings.

1. Use the ◀ or ▶ button to select the My Colors type.
2. Press the  button.

- The displayed image will reflect the My Colors effect.
- You can press the zoom lever toward  to check the image at a higher magnification. While the image is zoomed, you can press the **FUNC./SET** button to switch between the image transformed with the My Colors effect and the original non-transformed image.





### 4 Save.

1. Use the ◀ or ▶ button to select [OK].
2. Press the  button.

- The newly saved image transformed with the My Colors effect will be the last one in the list.
- To continue adding effects to other images, repeat the procedures from Step 2 onward.



### 5 Display the saved image.

1. Press the  button.
2. Use the ◀ or ▶ button to select [Yes].
3. Press the  button.

- If you select [No], the display will return to the Play menu.



You cannot add effects to RAW images using the My Colors function.



- The My Colors function will not work if there is insufficient space on the memory card.
- Although My Colors effects can be added any number of times to an image, the image quality will gradually deteriorate with each application and the intended colors may not be achieved.
- Color in images taken using My Colors (p. 140) in shooting mode and images edited with the My Colors function in playback mode may differ slightly.

## Resizing Images



You can resave images that were recorded at high recording pixel settings at lower settings.

<b>M3</b>	1600 × 1200 pixels
-----------	--------------------

<b>S</b>	640 × 480 pixels
----------	------------------



<b>XS</b>	320 × 240 pixels
-----------	------------------

### 1 Select [Resize].

1. Press the  button.
2. Use the  or  button to select  in the  menu.
3. Press the  button.



### 2 Select an image.

1. Use the  or  button to select an image you wish to resize.
  2. Press the  button.
- The **FUNC./SET** button is not selectable for images that cannot be resized.



### 3 Select a recording pixels.

1. Use the **←** or **→** button to select **M3**, **S** or **XS**.
2. Press the **FUNC. SET** button.



### 4 Save.

1. Use the **←** or **→** button to select **[OK]**.
2. Press the **FUNC. SET** button.

- The resized image will be saved in a new file.
- Some recording pixel settings cannot be selected depending on the available space of the memory card.



### 5 Display the saved image.

1. Press the **MENU** button.
2. Use the **←** or **→** button to select **[Yes]**.
3. Press the **FUNC. SET** button.

- If you select **[No]**, the display will return to the Play menu.



Images shot in **W** or **RAW** cannot be resized.

## Attaching Sound Memos to Images



In playback mode, you can attach sound memos (up to 1 minute) to an image.

### 1 Press the button while playing back images.

- The sound memo control panel will display.

### 2 Record.

1. Use the or button to select .

2. Press the button.

- The elapsed time and the remaining time display.
- Pressing the **FUNC./SET** button pauses the recording. Pressing it again resumes recording.
- Up to 1 minute of recordings can be added to any one image.
- The sound mode can be changed (p. 108).
- If you select using the or button and press the **FUNC./SET** button, the display will return to the Play menu.



Sound Memo Panel

Elapsed Time/  
Remaining Time

Volume (Adjust it with  
the or button)

## Sound Memo Panel

Use the or button to select and press the **FUNC./SET** button.

	Exit
	Record
	Pause
	Play
	Erase (Select [Erase] and in the confirmation screen press the <b>FUNC./SET</b> button.)
	Press the  or  button to adjust the volume.



- You cannot attach sound memos to movies.
- Sound memos for protected images cannot be erased.

## Sound-Only Recording (Sound Recorder)





You can record sound only, without images, for up to two hours at one time.



### 1 Select [Sound Recorder].

1. Press the  button.
2. Use the  or  button to select  in the  menu.
3. Press the  button.



### 2 Record a sound.

1. Use the  or  button to select .
2. Press the  button.

- Recording time will be displayed.
- Use the  or  button to change the sample rate. Sound quality will improve in the order of [11.025kHz], [22.050kHz], [44.100kHz], but the recorded file size will also increase respectively.
- When pressing the **FUNC./SET** button, recording will pause. Pressing the button once again will resume recording.
- Pressing the shutter button halfway or pressing the movie button will stop sound recording and switch the camera to shooting mode.
- The sound mode can be changed (p. 108).

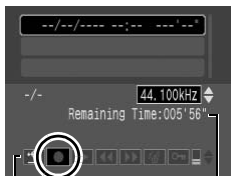









Sound  
Control  
Panel

Available  
Recording  
Time



## Sound Recorder Panel

Use the **←** or **→** button to select and press the **FUNC./SET** button.

	Exit
	Record
	Pause
	Play (Use the <b>↑</b> or <b>↓</b> button to select a sound and press the <b>FUNC./SET</b> button.)
	Rewind (Hold the <b>FUNC./SET</b> button to rewind (no sound plays).)
	Fast Forward (Hold the <b>FUNC./SET</b> button to fast forward (no sound plays).)
	Erase (Select [Erase] or [Erase All] and in the confirmation screen press the <b>FUNC./SET</b> button.)
	Protect (You can protect important sounds from accidental erasure. Press the <b>FUNC./SET</b> button to set/remove protection.)
	Press the <b>↑</b> or <b>↓</b> button to adjust the volume.



Make sure audio settings are correct (p. 108) before recording.



- See *Estimated Sound Recorder File Sizes and Recording Times* (p. 260).
- When the memory cards fills, recording will automatically stop.
- If you press and hold the  button while recording, the screen in Step 2 will display (briefly pressing the button will bring up the sound memo panel (p. 189)).

## Protecting Images



You can protect important images and movies from accidental erasure.



Select	You can configure the protection settings for each image singly while viewing them.
Select Range	You can select a range of sequential images and protect all the images in that range.
Select by Date	You can protect the images from a specified date.
Select by Category	You can protect all images in a specified category.
Select by Folder	You can protect all images in a specified folder.
All Images	You can protect all images on a memory card.

### 1 Select [Protect].

1. Press the  button.
2. Use the  or  button to select  in the  menu.
3. Press the  button.



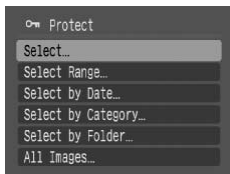

### 2 Select an image selection method.

1. Use the  or  button to select an image selection method.
  2. Press the  button.
- If you select [All Images], proceed to Sub-step 4 in Step 3 (p. 194).



### 3 Select images and protect them.

#### ● [Select]

1. Use the ◀ or ▶ button to select an image you wish to protect.
2. Press the  button.
3. Press the  button.



Protection Icon



- Pressing the **FUNC./SET** button again cancels the setting.
- Repeat the steps above to continue protecting other images.
- You can also protect images in the index playback mode.

#### ● [Select Range]

Refer to Step 4 of “Selecting a Range of Images” in “Organizing Images by Category (My Category)” (p. 169), for details on how to select images.

After selecting images, proceed with the following steps.



1. Use the ▲ or ▼ button to select [Protect].
2. Press the  button.
3. Press the  button.

● **[Select by Date] [Select by Category] [Select by Folder]**

1. Use the **▲** or **▼** button to select a date, category or folder.

2. Press the  button.

3. Press the  button.

- If a portion of the images are already protected,  appears gray.
- Pressing the **FUNC./SET** button again cancels the setting.
- You can select multiple dates, categories or folders.
- Use the **◀** or **▶** button to confirm each date, category or folder image.

4. Use the **▲** or **▼** button to select [Protect].

5. Press the  button.

6. Press the  button.

- Selecting [Unlock] cancels protection of the selected image and returns you to Step 2.
- Selecting [Stop] cancels selection of the protected image and returns you to Step 2.
- You may cancel the operation by pressing the **FUNC./SET** button during [Protect] mode.



## Erasing Images



You can erase images from a memory card.



- Note that erased images cannot be recovered. Exercise adequate caution before erasing an image.
- Protected images cannot be erased with this function.



Select	Erases images after selecting them one at a time.
Select Range	You can select a range of sequential images and erase all the images in that range.
Select by Date	Erases images corresponding to the selected date.
Select by Category	Erases all images in the selected category.
Select by Folder	Erases all images in the selected folder.
All Images	Erases all images on a memory card.

### 1 Select [Erase].

1. Press the  button.
2. Use the  or  button to select  in the  menu.
3. Press the  button.



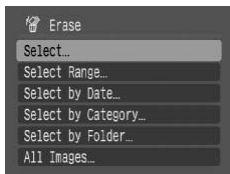

### 2 Select an image selection method.

1. Use the  or  button to select an image selection method.
  2. Press the  button.
- Proceed to Sub-step 4 in Step 3 (p. 197) if you select [All Images].



### 3 Select images and erase them.

#### • [Select]

1. Use the ◀ or ▶ button to select an image you wish to erase.
2. Press the  button.
3. Press the  button to complete the setting.
4. Use the ◀ or ▶ button to select [OK].
5. Press the  button.



- Pressing the **FUNC./SET** button again cancels the setting.
- You can also protect images in the index playback mode.

#### • [Select Range]

Refer to Step 4 of “Selecting a Range of Images” in “Organizing Images by Category (My Category)” (p. 169), for details on how to select images.

After selecting images, proceed with the following steps.

1. Use the ▲ or ▼ button to select [Erase].
2. Press the  button.



- **[Select by Date] [Select by Category] [Select by Folder]**

1. Use the **▲** or **▼** button to select a date, category or folder.

2. Press the  button.

3. Press the  button.

- Pressing the **FUNC./SET** button again cancels the setting.
- You can select multiple dates, categories or folders.
- Use the **◀** or **▶** button to confirm each date, category or folder image.

4. Use the **◀** or **▶** button to select [OK].

5. Press the  button.

- Selecting [Cancel] cancels selection of the image you are about to erase.
- Pressing the **FUNC./SET** button while erasing is in progress cancels the procedure.

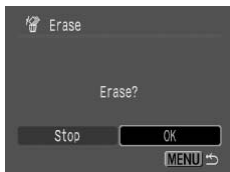

Please format the memory card when you want to erase not only image data but also all the data contained on the card (p. 69).

## Print Settings/Transfer Settings

### Setting the DPOF Print Setting





You can select images on a memory card for printing and specify the number of print copies in advance using the camera. The settings used on the camera comply with the Digital Print Order Format (DPOF) standards. This is extremely convenient for printing on a direct print compatible printer, or for sending the images to a photo developing service that supports DPOF.

**The  icon may display for a memory card with print settings set by a different DPOF-compliant camera. These settings will be overwritten by those set by your camera.**

### Setting the Print Style









After setting the print style, select the images for printing. The following settings can be selected.

\* Default setting.

Print Type	 Standard*	Prints one image per page.
	 Index	Prints the selected images together at a reduced size in an index format.
	 Both	Prints the images in both the standard and index formats.
 Date (On/Off*)		Adds the date to the print.
 File No. (On*)		Adds the file number to the print.
Clear DPOF data (On*)		Clears all print settings after the images print.





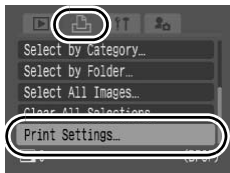

## 1 Select [Print Settings].

1. Press the  button.
2. Press the  button.
3. Use the  or  button to select the  menu.
4. Use the  or  button to select [Print Settings].
5. Press the  button.



## 2 Make settings.

1. Use the  or  button to select [Print Type], [Date], [File No.] or [Clear DPOF data].
2. Use the  or  button to specify the settings.
3. Press the  button.

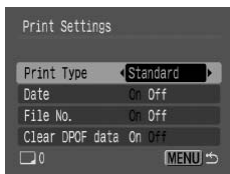

- The Date and File No. settings change according to the Print Type as follows.
  - [Index]:  
[Date] and [File No.] cannot be set to [On] at the same time.
  - [Standard] or [Both]:  
[Date] and [File No.] can be set to [On] at the same time, however, the printable information may vary between printers.
- Dates print in the style specified in the [Date/Time] menu (p. 52).

## Image Selection Methods









Select Images & Qty.	Configures print settings for single images as you view them.
Select Range	You can select a range of sequential images and make print settings for all the images in that range.
Select by Date	Configures print settings for images corresponding to the selected date.
Select by Category	Configures print settings for images in the selected category.
Select by Folder	Configures print settings for images in the selected folder.
Select All Images	Configures print settings for all images.
Clear All Selections	Removes all print settings from images.



Print settings are configured for each image individually. With the [Select Images & Qty.] option, you can only set the number of copies to print when the [Print Type] option is set to [Standard] or [Both] (p. 198).

### 1

#### Select an image selection method.

1. Press the  button.
2. Press the  button.
3. Use the  or  button to select the  menu.
4. Use the  or  button to select an image selection method.
5. Press the  button.

- When selecting [Select All Images] go to Sub-step 4 in Step 2 (p. 202).

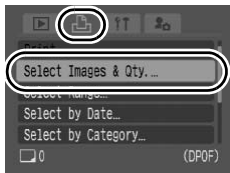







## 2 Select an image and make print settings.

### ● [Select Images & Qty.]

Selection methods differ for the Print Type settings (p. 198).





#### Standard ( )/Both ( ) (p. 198)

1. Use the  or  button to select an image.
2. Press the  button.
3. Use the  or  button to select the number of print copies (up to 99).
4. Press the  button.

Number of Print Copies



#### Index ( ) (p. 198)

1. Use the  or  button to select an image.
  2. Press the  button to select or deselect it.
  3. Press the  button.
- You can also select images in the index playback mode.
  - Pressing the **MENU** button will end the setting.



Index Print Selection





### ● [Select Range]

Refer to Step 4 of “Selecting a Range of Images” in “Organizing Images by Category (My Category)” (p. 169), for details on how to select images.

After selecting images, proceed with the following steps.

1. Use the  or  button to select [Order].
2. Press the  button.
3. Press the  button.

● **[Select by Date] [Select by Category] [Select by Folder]**



1. Use the  or  button to select a date, category or folder.



2. Press the  button.

3. Press the  button.

- Pressing the **FUNC./SET** button again cancels the setting.

- You can select multiple dates, categories or folders.

- Pressing the  or  button will allow you to check the images by date, category or folder.

4. Use the  or  button to select [OK].

5. Press the  button.

- Selecting [Cancel] cancels print settings of the selected image and returns you to Step 1.

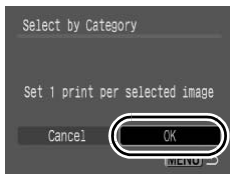



- The output of some printers or photo developing services may not reflect the specified print settings.

- Print settings cannot be set for movies and **RAW**.



- Images are printed in order according to the file number.

- A maximum of 998 images can be selected.

- If you are connected to a printer, the  button will light blue while you are selecting images. You can start printing at this point by pressing the  button, confirming that [Print] is selected and pressing the **FUNC./SET** button.







## Setting the DPOF Transfer Settings

You can use the camera to specify settings for images before downloading to a computer. Refer to the *Software Starter Guide* for instructions on how to transfer images to your computer. The settings used on the camera comply with the Digital Print Order Format (DPOF) standards.

The  icon may display for a memory card with transfer settings set by a different DPOF-compliant camera. These settings will be overwritten by those set by your camera.



### Single Images

#### 1 Select [Transfer Order].

1. Press the  button.
2. Press the  button.
3. Use the  or  button to select  in the  menu.
4. Press the  button.







#### 2 Select [Order].

1. Use the  or  button to select [Order].
2. Press the  button.
  - Selecting [Reset] cancels all transfer order settings.



#### 3 Select an image.

1. Use the  or  button to select an image to transfer.
2. Press the  button.
  - Pressing the **FUNC./SET** button again deselects the setting.
  - You can also select images in the index playback mode.
3. Press the  button several times to end the setting.

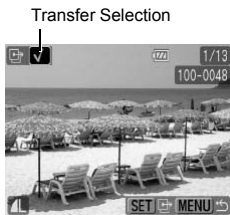



## All the Images on a Memory Card

### 1 Select [Transfer Order].

1. Press the  button.
2. Use the  or  button to select  in the  menu.
3. Press the  button.







### 2 Select [Mark all].

1. Use the  or  button to select [Mark all].
  2. Press the  button.
- Selecting [Reset] cancels all transfer order settings.



### 3 Select [OK].

1. Use the  or  button to select [OK].
2. Press the  button.
3. Press the  button.



- Images are transferred in order according to the file number.
- A maximum of 998 images can be selected.

## Connecting a TV set

### Viewing Images on a TV set



You can shoot or play back images on a television with the supplied AV cable.

#### 1 Turn off the camera and the TV.

#### 2 Connect the AV cable to the camera's A/V OUT terminal.

- Open the camera's terminal cover and plug the AV cable in all the way.

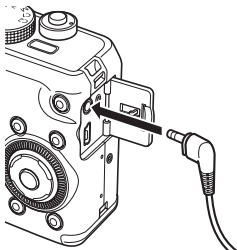

#### 3 Plug the other ends of the AV cable to the VIDEO IN and AUDIO IN jacks on the TV.

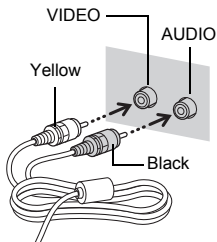

#### 4 Turn on the TV and switch it to Video mode.

#### 5 Turn on the camera.



- The video output signal can be switched (NTSC or PAL) to accommodate different regional standards (pp. 47, 52). The default setting varies between regions.
  - NTSC: Japan, U.S.A., Canada, Taiwan and others
  - PAL: Europe, Asia (excluding Taiwan), Oceania and others
  - If the video system is set incorrectly, the camera output may not display properly.
- When the camera is set to shooting mode, you can take pictures while displaying images on the television.









## Customizing the Camera (My Camera Settings)

My Camera allows you to customize the start-up image and startup, operation, self-timer and shutter sounds. You can change and register these settings, enabling you to customize the camera to suit your own tastes.

### Changing My Camera Settings



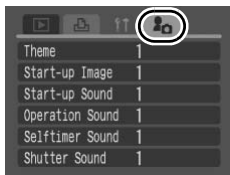

#### 1 Select the menu item.

1. Press the  button.
2. Use the  or  button to select the  menu.
3. Use the  or  button to select the menu item.



- Select [Theme] to set all to the same settings.

#### 2 Make settings.

1. Use the  or  button to select the contents you wish to set.
2. Press the  button.

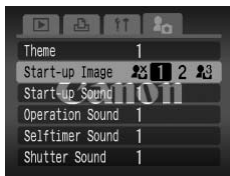

When [Shutter Sound] is set to **1** or **2**, a shutter sound matching the shutter speed will play.

## Registering My Camera Settings



Images recorded onto the memory card and newly recorded sounds can be added as My Camera settings to the menu items. You can also use the supplied software to upload your computer's images and sounds to the camera.



A computer is required to restore the My Camera settings to the defaults. Use the supplied software (ZoomBrowser EX/ImageBrowser) to restore the default settings to the camera.

### 1 Select the menu item.

1. Press the button.
2. Press the button.
3. Use the or button to select the menu.
4. Use the or button to select the menu item you wish to register.

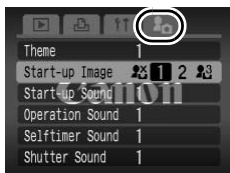

- Select [Theme] to register all to the same settings.

### 2 Select .

1. Use the or button to select .
2. Press the button.

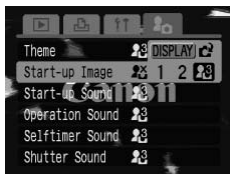





### 3 Select an image or record a sound you wish to register.

#### • Start-up Image



1. Use the or button to select the image you wish to register.
2. Press the button.



- **Start-up, Operation, Self-timer and Shutter Sounds**

1. Use the ◀ or ▶ button to select  (Record).
2. Press the  button.
3. After recording, use the ◀ or ▶ button to select  (Register).
4. Press the  button.



- Recording will automatically stop when the recording time elapses.
- To play it, select  (Play).
- To return the My Camera menu, press  (Exit).

#### 4 Register.

1. Use the ◀ or ▶ button to select [OK].
2. Press the  button.



- The following cannot be registered as My Camera settings.
  - Movies
  - Sounds recorded with the sound memo function (p. 189) and sound recorder (p. 190)
- The prior setting is erased when a new My Camera setting is added.



See the supplied *Software Starter Guide* for more information on creating and adding to the My Camera data.

## Troubleshooting

- Camera (p. 210)
- When the power is turned on (p. 211)
- LCD monitor (p. 211)
- Shooting (p. 213)
- Shooting movies (p. 217)
- Playback (p. 218)
- Battery/Battery Charger (p. 219)
- TV monitor output (p. 219)
- Printing with a direct print compatible printer (p. 219)

## Camera

### Camera will not operate.

Power is not turned on.	<ul style="list-style-type: none"> <li>● Press the power button (p. 42).</li> </ul>
Memory card slot/battery cover is open.	<ul style="list-style-type: none"> <li>● Confirm that the cover is securely closed (p. 11).</li> </ul>
Battery charge is low and the camera will not operate. ("Change the battery pack" message displays).	<ul style="list-style-type: none"> <li>● Insert a fully charged battery into the camera (p. 10).</li> <li>● Use the AC Adapter Kit ACK-DC20 (sold separately) (p. 234).</li> </ul>
Poor contact between camera and battery terminals.	<ul style="list-style-type: none"> <li>● Polish the terminals with a soft cotton swab before charging or using the battery (p. 230).</li> </ul>

### Sounds come from the camera interior.

The camera's horizontal/vertical orientation was changed.	<ul style="list-style-type: none"> <li>● The camera's orientation mechanism is operating. There is no malfunction.</li> </ul>
---	---

## When the power is turned on

### “Card locked!” message appears.

The SD memory card's or SDHC memory card's write protect tab is set to “Write protect”.

- When recording to, erasing from or formatting the memory card, slide the write protect tab upward (p. 232).

### The Date/Time menu appears.

The built-in rechargeable lithium battery charge is low.

- Recharge the built-in battery immediately (p. 10).

## LCD monitor

### Nothing displays.

The LCD monitor is set not to display.

- Press the **DISPLAY** button to turn on the LCD monitor (p. 55).

### The LCD monitor will shut off during shooting.

If [Power Saving] is set to [Display Off], the power saving function will shut down the LCD monitor while shooting in  mode. The LCD monitor will turn on if a button other than the power switch or shutter button is operated.

### Camera screen is black at start-up

Incompatible image has been selected as the startup image in the My Camera Settings.

- Change the start-up image in the My Camera Settings (p. 207) or use the supplied ZoomBrowser EX or ImageBrowser program to restore the default settings. See *ZoomBrowser EX/ImageBrowser Software User Guide (PDF)* for ZoomBrowser EX or ImageBrowser.

### The display darkens.

The image in the LCD monitor will darken in strong sunlight or bright light.

- This is a normal occurrence in devices containing CCDs and does not constitute a malfunction (this image will not be recorded when shooting still images, but it will be recorded when shooting movies).

### Display flickers.

Display flickers when shot under fluorescent lighting.

- This is not a camera malfunction (flickering recorded in movies, but not in still images).

### A bar of light (purplish red) appears on the LCD Monitor

Sometimes appears when shooting a bright subject, such as the sun or other light source.

- This is a normal occurrence in devices containing CCDs and does not constitute a malfunction (this bar of light will not be recorded when shooting still images, but it will be recorded when shooting movies).
- Setting the ND Filter on may reduce this bar of light (p. 132).

### appears.

A slow shutter speed has likely been selected because of insufficient lighting.

- Set the Image Stabilizer to other than [Off] (p. 82).
- Raise the ISO speed (p. 84).
- Set the Auto ISO Shift (p. 133).
- Set the flash to any setting other than  (flash off) (p. 74).
- Set the self-timer and secure the camera to something, such as a tripod (p. 76).

**▲ appears.**

This displays when using a memory card that has print settings, transfer settings or slide show image settings set by other DPOF-compliant cameras.

- These settings will be overwritten by those set by your camera (pp. 198, 203, 176).

**Noise displays./Subject's movements are irregular.**

Camera automatically lightened the image displayed on the LCD monitor to make it easier to see when shooting in a dark area (p. 57).

- There is no effect on the recorded image.

**Shooting****Camera will not record.**

Camera is in playback mode.

- Switch to Shooting mode (p. 54).

Flash is charging.

- When the flash is charged, the indicator will light orange. Shooting is now possible (p. 44).

Memory card is full.

- Insert a new memory card (p. 12).
- If required, download the images to a computer and erase them from the memory card to make space.

Memory card is not formatted correctly.

- Format the memory card (p. 69).
- If reformatting does not work, the memory card logic circuits may be damaged. Consult the nearest Canon Customer Support Help Desk.

SD memory card or SDHC memory card is write protected.

- Slide the write protect tab upward (p. 232).

### **Image Seen in Viewfinder vs. Recorded Image.**

Usually the recorded image contains more of the scene than is seen in the viewfinder.

- Confirm the actual image size with the LCD monitor. Use the LCD monitor when taking close-up shots (p. 75).

### **Image is blurred or out of focus.**

The camera moves when the shutter button is pressed.

- Confirm the procedures in “ appears” (p. 212).

AF-assist Beam is set to [Off].

- In dark places where it is difficult for the camera to focus, the AF-assist Beam will emit to assist focusing. As the AF-assist Beam will not function when turned off, set it [On] to activate it (p. 49). Take care not to obstruct the AF-assist Beam with your hand when used.

Subject is out of focal range.

- Shoot with the subject at the correct focusing distance (p. 252).
- The camera may be set to an unintended function (such as macro). Cancel the setting.

The subject is hard to focus on.

- Use the focus lock, AF lock or manual focus to shoot (p. 123).

### **Subject in recorded image is too dark.**

Insufficient light for shooting.

- Set the built-in flash to  (Flash on) (p. 74).
- Use a high-output externally mounted flash.
- Set [ND Filter] to [Off] (p. 132).

The subject is underexposed because the surroundings are too bright.

- Set the exposure compensation to a positive (+) setting (p. 135).
- Use the AE lock or spot metering function (pp. 128, 136).





Subject is too far away for flash to reach.	<ul style="list-style-type: none"> <li>● Shoot within correct flash range of the subject when using the built-in flash (p. 253).</li> <li>● Raise the ISO speed and then shoot (p. 84).</li> </ul>
---	--

### Subject in recorded image is too bright, or image flashes white.











Subject is too close, making the flash too strong.	<ul style="list-style-type: none"> <li>● Shoot within correct flash range of the subject when using the built-in flash (p. 253).</li> <li>● Set the safety FE to [On] (p. 152).</li> </ul>
--	--

The subject is overexposed because the surroundings are too dark.	<ul style="list-style-type: none"> <li>● Set the exposure compensation to a negative (–) setting (p. 135).</li> <li>● Use the AE lock or spot metering function (pp. 128, 136).</li> <li>● Set [ND Filter] to [On] (p. 132).</li> </ul>
---	---

Too much light is shining directly into the camera, or is being reflected off the subject.	<ul style="list-style-type: none"> <li>● Change the shooting angle.</li> </ul>
--	--

Flash is set to  (Flash on).	<ul style="list-style-type: none"> <li>● Set the flash to  (Flash off) (p. 74).</li> </ul>
---	---

### Image contains noise.

ISO speed is too high.	<ul style="list-style-type: none"> <li>● Higher ISO speeds and  (High ISO Auto) setting may increase image noise. For higher image quality, use as low an ISO speed as possible (p. 84).</li> <li>● In , , , , , , ,  and  modes in the SCN mode, the ISO speed increases and noise can appear.</li> </ul>
------------------------	--

**White dots appear on the image.**

Light from the flash has reflected off dust particles or insects in the air. This is particularly noticeable when shooting using the wide angle or when you increase the aperture value in the aperture-priority **Av** mode.

- This is a phenomenon that occurs with digital cameras and does not constitute a malfunction.

**Eyes appear red.**

Light is reflected back from the eyes when the flash is used in dark areas.

- Shoot with [Red-Eye] set to [On] (p. 113). For this mode to be effective, the subject must be looking right at the red-eye reduction lamp. Try asking them to look directly at the lamp. Even better results can be obtained by increasing the lighting in indoor settings or approaching closer to the subject. The shutter will not activate for approximately 1 second after the red-eye reduction lamp fires in order to improve the effect.
- You can correct red eyes in recorded images using the [Red-Eye Correction] (p. 180).

**Continuous shooting slows down.**

The memory card's performance has dropped.

- To enhance the continuous shooting performance, you are recommended to low level format the memory card in the camera after you save all its images to your computer (p. 69).

**Recording images to memory card takes a long time.**

Memory card was formatted in another device.

- Use a memory card formatted in your camera (p. 69).

**Lens will not retract.**

Memory card slot/battery cover was opened with power on.

- After closing the memory card slot/battery cover, turn the power on then back off.

**Shooting movies****The recording time may not display properly or shooting may stop unexpectedly.**

The following types of memory cards are used.

- Slow recording cards.
- Cards formatted on a different camera or a computer.
- Cards which have had images recorded and erased repeatedly.

- Although the recording time may not display properly during shooting, the movie will be recorded correctly on the memory card. Recording time will display properly if you format the memory card in this camera (excluding slow recording memory cards) (p. 69).

**“!” displayed on the LCD monitor in red and shooting automatically stopped.**

There is insufficient free space in the camera's built-in memory.

- Try the following procedures.
  - Format the card with a low level format before filming (p. 69).
  - Lower the recording pixels or frame rate (p. 106).
  - Use a high-speed memory card (SDC-512MSH, etc.).

**Zoom does not operate.**

Zoom lever was pressed while shooting in movie mode.

- Operate the zoom before shooting in movie mode (p. 71). Note the digital zoom is available while shooting (only in Standard movie mode).

## Playback

### Cannot play back.

You attempted to play back images shot with another camera or images edited with a computer.

- Computer images that cannot be played back may play back if they are added to the camera using the supplied software program ZoomBrowser EX or ImageBrowser. See *ZoomBrowser EX/ImageBrowser Software User Guide (PDF)*.

File name was changed with a computer or file location was changed.

- Set the file name or location on the file format/structure of the camera. (Refer to the *Software Starter Guide* for details).

### Images cannot be edited.

Some images shot with another camera cannot be edited.

### Movies do not play back correctly.

Movies recorded with high recording pixels may momentarily stop playing if played on slow reading memory cards.

You may experience frame dropping and audio breakup when playing back a movie on a computer with insufficient system resources.

### Reading images from memory card is slow.

Memory card was formatted in another device.

- Use a memory card formatted in your camera (p. 69).

## Battery/Battery Charger

### Battery consumed quickly.

Battery is not being used to its full capacity.	● See <i>Battery Handling Precautions</i> (p. 230).
Battery life exceeded if battery loses its charge quickly at normal temperature (23°C/73°F).	● Replace the battery with a new one (p. 11).

### Battery will not charge.

Battery life exceeded.	● Replace the battery with a new one (p. 11).
------------------------	---

## TV monitor output

### Image is distorted or not showing on TV monitor.

Incorrect video system setting.	● Set the video system to the appropriate setting, NTSC or PAL, for your TV (p. 52).
Shooting in Stitch Assist mode.	● The output will not appear on a TV in Stitch Assist mode. Shoot in a different mode (p. 100).

## Printing with a direct print compatible printer

### Cannot print.

The camera and printer are not properly connected.	● Securely connect the camera and printer with the specified cable.
The printer power is not turned on.	● Turn on the printer power.
The print connection method is not correct.	● In the <b>[1]</b> (Set up) menu, select [Print Method] and select [Auto] (p. 52).

## List of Messages

The following messages may appear on the LCD monitor during shooting or playback.

Please refer to the *Direct Print User Guide* for the messages that display during a printer connection.

### Busy...

Image is being recorded to the memory card, or the playback mode is starting up.

### No memory card

You turned on the camera without a memory card installed, or with a memory card installed in the wrong orientation (p. 12).

### Card locked!

The SD memory card or SDHC memory card is write protected (p. 232).

### Cannot record!

You attempted to shoot an image without a memory card installed, with a memory card installed in the wrong orientation, or attempted to attach a sound memo to a movie.

### Memory card error

The memory card may be malfunctioning. By formatting the malfunctioning memory card with the camera, you may be able to continue using it (p. 69). However, if this error message appears even when using the supplied memory card, contact your Canon Customer Support Help Desk as there may be a problem with the camera.

### Memory card full

Memory card is full of images and no more can be recorded or saved. In addition, no more image settings, or sounds or sound memos can be recorded.

---

**Naming error!**

The file name could not be created because there is an image with the same name as the folder that the camera is attempting to create, or the highest possible file number has already been reached. In the Set up menu, set [File Numbering] to [Auto Reset]; alternatively, save all the images you wish to retain onto a computer, then reformat the memory card. Please note that formatting will erase all the existing images and other data.

**Change the battery pack.**

Battery charge is insufficient to operate the camera. Replace it at once with a charged one or recharge the battery.

**No image**

No images recorded on memory card.

**Image too large**

You attempted to play back an image larger than 5616 × 3744 pixels or with a large data size.

**Incompatible JPEG**

You attempted to play back an incompatible JPEG image (an image that has been downloaded to a computer and altered., etc.).

**RAW**

You attempted to play back a different type of RAW image.

**Unidentified Image**

You attempted to play back a corrupted image, an incompatible image (proprietary format used by another manufacturer's camera, etc.), an image edited on a computer or a movie clip recorded by another camera.

**Cannot magnify!**

You attempted to magnify an image recorded in a different camera or data type, an image edited with a computer, or a movie.

**Cannot rotate**

You attempted to rotate an image recorded in a different camera or data type, an image edited with a computer.

---

**Incompatible WAVE**

A sound memo cannot be added to this image since the data type of the existing sound memo is incorrect, or the sound memo cannot be played back.

**Cannot register this image!**

You attempted to register an image recorded in a different camera, a Raw image or a movie as a startup image.

**Cannot modify image**

You attempted to resize or perform red eye correction on a movie, RAW image or an image recorded with another camera; or you attempted to resize an image recorded using **[W]**, or already resized to **[XS]**.

**Cannot assign to category**

You attempted to categorize an image recorded in a different camera.

**Cannot Modify**

Cannot apply red-eye correction as no red-eye is detected.

**Cannot transfer!**

When transferring images to your computer using the Direct Transfer menu, you attempted to select a RAW image, an image with corrupted data, an image taken with a different camera or data type. You may have also attempted to select a movie when [Wallpaper] was selected in the Direct Transfer menu.

**Protected!**

You attempted to erase or edit a protected image, movie or sound memo.

**Too many marks**

Too many images have been marked with print settings, transfer settings or slide show image settings. Cannot process any more.

**Cannot complete!**

Could not save a part of the print, transfer or slide show settings.

**Unselectable image**

You attempted to set the print settings for a non-JPEG image.

---



**Cannot select**

In selecting the image range for categorizing via the My Category function, protecting images, erasing images or specifying print settings, you selected a starting image with a file number higher than the last image or a last image with a file number lower than the starting image. Or, you specified more than 500 images.

**Communication error**

The computer was unable to download the image due to the large amount of images (approx. 1000) stored on the memory card. Use a USB card reader or a PCMCIA card adapter to download the images.

**Lens error, restart camera**

An error was detected while the lens was in motion, and the power has been automatically turned off. This error can occur if you hold the lens while it is in motion or you operate it in a location with excessive dust or sand in the air. Try turning the power back on, and resume shooting or playback. If this message continues to display, contact your Canon Customer Support Help Desk as there may be a problem with the lens.

**Exx**

(xx: number) Camera detected an error. Turn the power off and then back on, then shoot or play back. A problem exists if the error code reappears. Note the number and contact your Canon Customer Support Help Desk. If an error code displays directly after taking a picture, the shot may not have been recorded. Check image in playback mode.

---

## Appendix

### Safety Precautions

- Before using the camera, please ensure that you read the safety precautions described below. Always ensure that the camera is operated correctly.
- The safety precautions noted on the following pages are intended to instruct you in the safe and correct operation of the camera and its accessories to prevent injuries or damage to yourself, other persons and equipment.
- Equipment refers to the camera, battery charger, compact power adapter (sold separately) and car battery charger (sold separately).
- Battery refers to the battery pack.

### ⚠ Warnings

#### Equipment

- **Do not point the camera directly at the sun or bright light sources.**
  - Doing so could damage the camera's CCD.
  - Doing so can damage your eyesight.
- **Store this equipment out of the reach of children and infants.**
  - Neck strap: Placement of the strap around the child's neck could result in asphyxiation.
  - Memory card: It may be swallowed accidentally. If this occurs, contact a doctor immediately.

- **Do not attempt to disassemble or alter any part of the equipment that is not expressly described in this guide.**
- **To avoid the risk of high-voltage electrical shock, do not touch the flash portion of the camera if it has been damaged.**
- **Stop operating the equipment immediately if it emits smoke or noxious fumes.**
- **Do not allow the equipment to come into contact with, or become immersed in, water or other liquids. If the exterior comes into contact with liquids or salt air, wipe it dry with a soft, absorbent cloth.**

Continued use of the equipment may result in fire or electrical shock. Immediately turn the camera power off and remove the camera battery or unplug the battery charger or compact power adapter from the power outlet.

Please consult your camera distributor or the closest Canon Customer Support Help Desk.

- **Do not use substances containing alcohol, benzene, thinners or other flammable substances to clean or maintain the equipment.**
- **Do not cut, damage, alter or place heavy items on the power cord.**
- **Use only recommended power accessories.**
- **Remove the power cord on a regular periodic basis and wipe away the dust and dirt that collects on the plug, the exterior of the power outlet and the surrounding area.**
- **Do not handle the power cord if your hands are wet.**

Continued use of the equipment may result in fire or electrical shock.

## Battery

- **Do not place the batteries near a heat source or expose it to direct flame or heat.**
- **The batteries should not be immersed in water or sea water.**
- **Do not attempt to disassemble, alter or apply heat to the batteries.**
- **Avoid dropping or subjecting the batteries to severe impacts that could damage the casing.**
- **Use only recommended batteries and accessories.**

Use of batteries not expressly recommended for this equipment may cause explosions or leaks, resulting in fire, injury and damage to the surroundings. In the event that a battery leaks and the eyes, mouth, skin or clothing contact these substances, immediately flush with water and seek medical assistance.

- **Disconnect the battery charger and compact power adapter from both the camera and the power outlet after recharging or when not in use to avoid fire and other hazards.**
- **Do not place anything, such as tablecloths, carpets, bedding or cushions, on top of the battery charger while it is charging.**

Continued use over a long period may cause the units to overheat and distort, resulting in fire.

- **When recharging the battery, use only a specified battery charger.**
- **The battery charger and compact power adapter are designed for exclusive use with this equipment. Do not use it with other products.**

There is a risk of overheating and distortion which could result in fire or electrical shock.

- **Before you discard a battery, cover the terminals with tape or other insulators to prevent direct contact with other objects.**

Contact with the metallic components of other materials in waste containers may lead to fire or explosions.

## Others

- **Do not trigger the flash in close proximity to human or animal eyes. Exposure to the intense light produced by the flash may damage eyesight.**

In particular, remain at least one meter (39 inches) away from infants when using the flash.

- **Keep objects that are sensitive to magnetic fields (such as credit cards) away from the speaker of the camera.**

Such items may lose data or stop working.

- **When using the optional Canon Wide Converter, Tele Converter or Conversion Lens Adapter, be sure to attach them firmly.**

If the lens becomes loose and falls off, it may crack, and the shards of glass may lead to cuts.

## ⚠ Cautions

### Equipment

- **Do not get the camera caught on other objects or subject it to strong impacts or shocks when wearing or holding it by the neck strap.**

- **Be careful not to bump or strongly push the end of the lens.**

The above-mentioned could lead to injury or damage the equipment.

- **Do not store the equipment in humid or dusty areas.**

- **Do not allow metal objects (such as pins or keys) or dirt to contact the charger terminals or plug.**

Such conditions could lead to fire, electrical shock or other damage.

- **Avoid using, placing or storing the equipment in places subject to strong sunlight or high temperatures, such as the dashboard or trunk (boot) of a car.**
- **Do not use the camera in such a way that would cause it to exceed the rating of the power outlet or wiring. Do not use if the power cord or plug are damaged, or if not fully plugged into the outlet.**
- **Do not use in locations with poor ventilation.**

The above-mentioned can cause leakage, overheating or explosion, resulting in fire, burns or other injuries. High temperatures may also cause deformation of the casing.

- **When not using the camera for extended periods of time, remove the battery from the camera or battery charger and store the equipment in a safe place.**

If the batteries are left inside the camera, damage caused by leakage may occur.

### **Flash**

- **Do not operate the flash with dirt, dust or other items stuck to the surface of the flash.**
- **Be careful not to cover the flash with your fingers or clothing when shooting.**

The flash may be damaged and emit smoke or noise. The resulting heat build-up could damage the flash.

- **Do not touch the surface of the flash after taking several pictures in rapid succession.**

Doing so could result in burns.

## Preventing Malfunctions

### Avoid Strong Magnetic Fields

- **Never place the camera in close proximity to electric motors or other equipment generating strong electromagnetic fields.**

Exposure to strong magnetic fields may cause malfunctions or corrupt image data.

### Avoid Condensation Related Problems

- **When moving the equipment rapidly between hot and cold temperatures, you can avoid condensation by placing the equipment in an airtight, resealable plastic bag and letting it adjust to temperature changes slowly before removing it from the bag.**

Moving the equipment rapidly between hot and cold temperatures may cause condensation (water droplets) to form on its external and internal surfaces.

### If Condensation Forms Inside the Camera



- **Stop using the camera immediately.**

Continued use may damage the equipment. Remove the memory card and battery or compact power adapter from the camera and wait until the moisture evaporates completely before resuming use.

## Battery Handling

### Battery Charge

The following icon and message will display.

Display	Summary
	Sufficient battery charge.
	If you are planning to use the camera for a long period of time, you are recommended to use a fully charged battery, or, to charge the battery in advance.
 (Blinking Red)	Battery charge is low. Recharge the battery.
Change the battery pack.	Battery charge is insufficient to operate the camera. Replace the battery immediately.

## Battery Handling Precautions

- **Keep the battery terminals clean at all times.**

Dirty terminals may cause poor contact between the battery and camera. Polish the terminals with a soft cotton swab before charging or using the battery.

- **At low temperatures, battery performance may be reduced and the low battery icon (  ) may appear earlier than usual.**

Under these conditions, revive the battery by warming it in a pocket immediately before use.

- **However, ensure that there are no metallic items in the pocket that could cause a short circuit, such as a key ring, etc.**

The battery may short circuit.

- **Do not allow any metal objects such as key rings to touch the (⊕) and (⊖) terminals (Fig. A). To carry the battery or store it during periods of disuse, always replace the terminal cover (Fig. B).**

These conditions can damage the battery. You may be able to check the charge state depending upon how the terminal cover is attached (Fig. C, D).

Fig. A



Fig. B

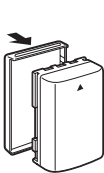
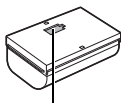
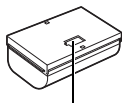

Fig. C  
Fully Charged  
Battery



Insert the battery pack so the blue area is visible.

Fig. D  
Used Battery



Attach in the opposite way of Fig. C.

- **You are recommended to use it in the camera until it is completely discharged and to store it in an indoor location with low relative humidity and between the temperatures of 0 – 30 °C (32 – 86 °F).**

Storing a fully charged battery for long periods of time (about one year) may shorten its life cycle or affect its performance. If you do not use the battery for long periods of time, charge it fully and discharge it fully in the camera about once a year before returning it to storage.



## Charging the Battery

- **Since this is a lithium-ion battery, you need not completely discharge it before recharging.**
- **It takes approximately 1 hours 45 minutes to fully charge the battery from a depleted state (based on Canon's testing standards).**
- Charging it within a temperature range of 5 – 40 °C (41 – 104 °F) is recommended.
- Charge times may vary according to the ambient temperature and the battery's charge state.
- **You are advised to charge the battery on the day of use, or one day before, to ensure a full charge.**

Even charged batteries continue to discharge naturally.

- **If the performance of the battery diminishes substantially even when it is fully charged, its life has been exceeded and it should be replaced.**



### U.S.A. and Canada only:

The Lithium ion/polymer battery that powers the product is recyclable.

Please call 1-800-8-BATTERY for information on how to recycle this battery.

## Handling the Memory Card

### SD Memory Card or SDHC Memory Card Write Protect Tab

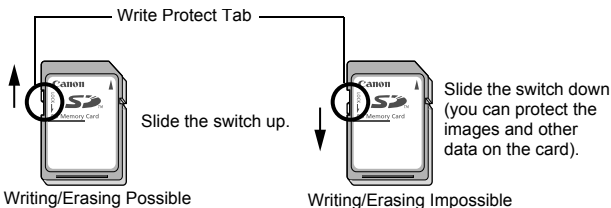

### Cautions When Handling

- Memory cards are high-precision electronic devices. Do not bend them, apply force to them, or subject them to shocks or vibration.
- Do not attempt to disassemble or alter the memory card.
- Do not allow dirt, water or foreign objects to contact the terminals on the back of the card. Do not touch the terminals with your hands or metal objects.
- Do not peel away the original label on the memory card or cover it with another label or sticker.
- When writing on the memory card, do not use a pencil or ball-point pen. Only use a soft point pen (e.g. felt-tip pen).
- Do not use or store memory cards in the following locations.
  - Locations subject to dust or sand
  - Locations subject to high humidity and high temperatures
- Since some or all of the data recorded on the memory card may be corrupted or erased by electrical noise, static electricity or card malfunction, making a backup copy of important data is recommended.

## Formatting

- **Please note that formatting (initializing) an memory card erases all data, including protected images.**
- **You are recommended to use memory cards that have been formatted in your camera.**
- The card supplied with the camera may be used without further formatting.
- When the camera is malfunctioning, a corrupted memory card might be the cause. Reformatting the memory card may solve the problem.
- When a non-Canon brand memory card is malfunctioning, reformatting it may solve the problem.
- Memory cards formatted in other cameras, computers, or peripheral devices may not operate correctly in this camera. When that happens, reformat the memory card with this camera.
- **If formatting in the camera does not work properly, turn the camera off and re-insert the memory card. Then turn the camera back on and format again.**
- **Be careful when transferring or disposing of a memory card. Formatting or erasing the data on a memory card merely changes the file management information on the card and does not ensure that its contents are completely deleted. When disposing of a memory card, take precautions, such as physically destroying the card, to prevent personal information leaks.**

## Using the Power Kits (Sold Separately)

### Using the AC Adapter Kit ACK-DC20

It is best to power the camera with AC Adapter Kit ACK-DC20 (sold separately) when you are using it for long periods of time or connecting it to a computer.



Turn the camera power off before connecting or disconnecting the AC adapter.

- 1 Attach the power cord to the compact power adapter and plug it into a power outlet.**

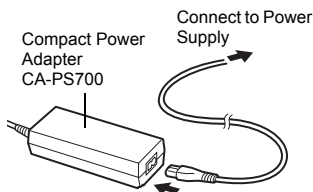

- 2 Connect the DC plug of the compact power adapter cable to the DC Coupler DR-20 terminal.**

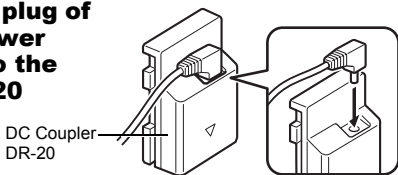

- 3 Open the cover, then insert the DC Coupler until it is locked.**

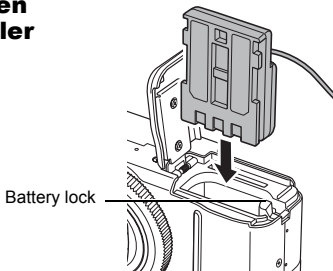

## 4 Press and hold the DC Coupler cable cover using the cable, then close the memory card slot/battery cover.

- Always disconnect the compact power adapter from the power supply after use.

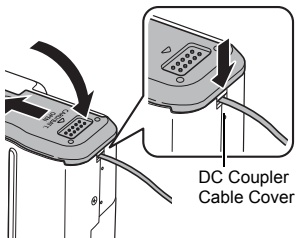

## Using the Car Battery Charger CBC-NB2

Car Battery Charger CBC-NB2 (sold separately) can be used to charge battery packs from an automobile's cigarette lighter socket.

Always ensure that the automobile's engine is running when you use the car battery charger. Use of it with the engine off may flatten the battery. Always unplug the car battery charger before turning off the engine.



- The battery will stop charging whenever you turn the engine off, so be sure to unplug the car battery cable from the cigarette lighter socket.
- Wait until the engine is running again to plug the car battery cable into the cigarette lighter socket.
- The car battery charger can only be used in a negative ground car. It cannot be used in a positive ground car.

## 1 With the engine running, plug the car battery cable into the cigarette lighter socket.

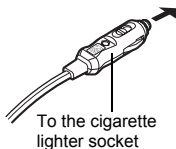

## 2 Insert the battery pack all the way into the battery charger as shown.

- Align the arrow on the battery pack and the arrow on the battery charger to correctly insert the battery pack in the charger.
- The charge indicator will light red while the battery pack is charging. It will change to green when the charge is complete.
- After charging, remove the battery pack and unplug the car battery cable from the cigarette lighter socket.

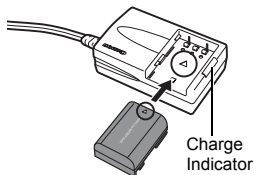

## Using the Lenses (Sold Separately)

When attaching the Wide Converter WC-DC58B and Tele-converter TC-DC58C (each sold separately) you also need the Conversion Lens Adapter LA-DC58H.



- When attaching the wide converter or tele-converter, be sure to screw it on securely. If they come loose, they may fall from the lens adapter, posing risk of injury from shattered glass.
- Never look into the sun or into strong light through the wide converter or tele-converter as this can result in blindness or impairment of vision.



- If the built-in flash is used with the lens hood attached, the outer edges of shot images (especially the lower right) may be darkened.
- When using the tele-converter, set the camera near the maximum telephoto. At other zoom settings, the image will appear as if its corners have been cut off.
- When using the wide converter, set the camera to the maximum wide angle.
- If you use the viewfinder for shooting, a portion of the view will be blocked by these attachments. Please use the LCD monitor.

### ■ Wide Converter WC-DC58B

Use this converter for taking wide-angle shots. The wide converter changes the focal length of the camera body's lens by a factor of 0.75x (the thread diameter is 58 mm).

### ■ Tele-converter TC-DC58C

This lens is used for taking telephoto shots. The lens changes the focal length of the camera body's lens by a factor of 2x. (the thread diameter is 58 mm).



It is not possible to attach a lens hood or filter to the wide converter or tele-converter.

### ■ Conversion Lens Adapter LA-DC58H

This is a lens adapter required for attaching the wide converter or tele-converter.

## Attaching a Lens

# 1

**Be sure that the camera is turned off.**

- 2** Press the ring release button (①) and hold it down, and turn the ring in the direction of the arrow (②).

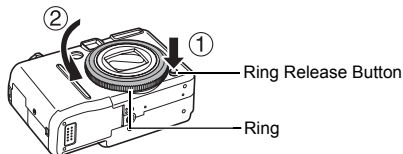

- 3** When the ○ mark on the ring and the ● mark on the camera are aligned, lift off the ring.

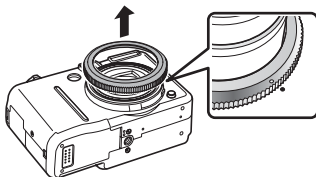

- 4** Align the ● mark on the conversion lens adapter with the ● mark on the camera, and turn the adapter in the direction of the arrows until locked.

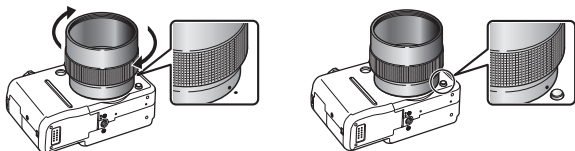

- To remove the conversion lens adapter, turn the adapter in the opposite direction with holding down the ring release button.



- 5 Set the lens on the adapter, and turn it in the indicated direction to attach it securely.**



- Completely remove all dust and dirt from conversion lenses with a lens blower brush before use. The camera may focus on any dirt that remains.
- Be careful when handling the lenses since it is easy to get finger prints on them.
- Be careful not to drop the camera or adapter when removing the ring.
- When using these lens attachments, you should not shoot images in  mode. It will not be possible to use the PhotoStitch software from your computer to accurately stitch the images together.

## Changing the Ring Color

You can change the color of the ring using the separately sold Ring Accessory Kit RAK-DC1.

- 1 Be sure that the camera is turned off.**

- 2 Press the ring release button (①) and hold it down, and turn the ring in the direction of the arrow (②).**

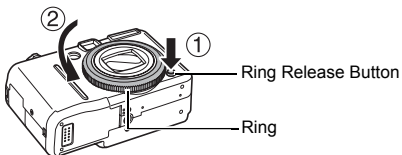

- 3** When the ○ mark on the ring and the ● mark on the camera are aligned, lift off the ring.

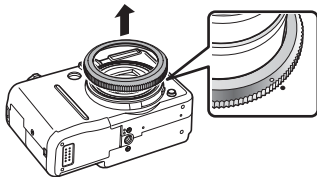

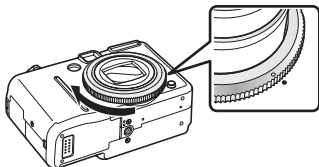

- 4** Align the ○ mark on the ring with the ● mark on the camera, and then turn the ring in the direction of the arrow.



## Converter Settings



Set up when shooting using the [IS Mode] (p. 82) by attaching the Wide Converter WC-DC58B or Tele-converter TC-DC58C, sold separately.

### 1 Select [Converter].

1. Press the  button.
2. Use the  or  button to select [Converter] in the  menu.



### 2 Make settings.

1. Use the  or  button to select [WC-DC58B] or [TC-DC58C].
2. Press the  button.
  - Select the attached converter.

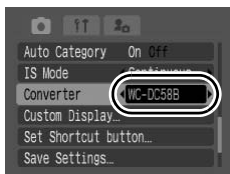

When you remove the converter from the camera, return the converter setting to [Off].

## Using an Externally Mounted Flash (Sold Separately)

➔ See Functions Available in Each Shooting Mode (p. 270).

Shooting Mode **AUTO** **SCN**\*   **P** **Tv** **Av** **M**

\* Cannot be set in ,  or  mode.

You can make your flash photography even clearer and more natural appearing with the use of a separately sold externally mounted flash. The camera's auto exposure function will operate with a Canon Speedlite 220EX, 430EX or 580EX II (except with the **M** mode or when [Flash Mode] is set to [Manual]). Other flashes may fire manually or not fire at all.

Please check the manual for your flash.

\* Certain functions noted in the manuals for the Canon Speedlite 220EX, 430EX and 580EX II cannot be performed when mounted on this camera. Please read this guide before using one of these flashes on the camera.



Since the camera's auto exposure function will trigger an externally mounted flash when shooting in **AUTO** or **SCN** mode, settings cannot be changed.

## Attaching the Externally Mounted Flash

- 1 Attach the flash to the camera's hot shoe.**

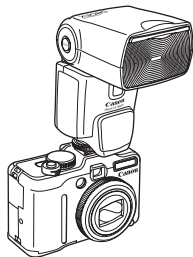

## 2 Turn the external flash on and turn the camera on.

-  (red) appears on the LCD monitor.

## 3 Turn the mode dial to the desired mode.

### ● Speedlite 220E or 430EX\*

- The maximum flash synchro shutter speed is 1/250 second.
- The flash will automatically adjust its output when [Flash Mode] is set to [Auto].
- When [Flash Mode] is set to [Auto] the flash exposure compensation can be adjusted. When [Flash Mode] is set to [Manual], the flash output can be adjusted (p. 149).
- When adjusting flash exposure compensation with both the camera and the flash (E-TTL mode), the flash settings will take priority and the camera settings will not function (430EX only).
- In **M** mode or when [Flash Mode] is set to [Manual], the output of an externally mounted flash can be adjusted in the flash output adjustment screen (p. 150). When a Speedlite 430EX is mounted on the camera, you can adjust the flash output from either the flash or the camera (the flash setting overrides the camera setting when both are set). To set it from the flash, use the flash's manual mode. When using Speed Light 220 EX, adjustment can be made on the camera only. You can also adjust the flash output even when the camera is set to the E-TTL automatic flash exposure compensation mode by changing the flash exposure compensation setting.

\* You can also use the 380EX, 420EX, 550EX and 580EX.

- **Speedlite 580EX II**

- The maximum flash synchro shutter speed is 1/250 second.
- The flash will automatically adjust its output when [Flash Mode] is set to [Auto].
- When [Flash Mode] is set to [Auto] the flash exposure compensation can be adjusted. When [Flash Mode] is set to [Manual], the flash output can be adjusted (pp. 149, 150).
- In **M** mode or when [Flash Mode] is set to [Manual], the output of an externally mounted flash can be adjusted in the flash output adjustment screen (p. 150). You can also adjust the flash output from the flash. For the optimum aperture values and ISO speeds for the distance to the subject, refer to the guide number listed in the flash's user guide.  
You can also adjust the flash output even when the camera is set to the E-TTL automatic flash exposure compensation mode by changing the flash exposure compensation setting.
- In **M** mode, you can set the flash output with the camera even if the flash unit is set to E-TTL automatic flash exposure compensation. [E-TTL] will display on the flash, but the flash will fire manually.

- **Other Canon Flashes**

- Since other flashes fire at full strength, set the shutter speed and aperture accordingly.

---

## **4 Press the shutter button halfway.**

- The flash is charged when its pilot lamp lights up.

---

## **5 Press the shutter button all the way to shoot the image.**

---



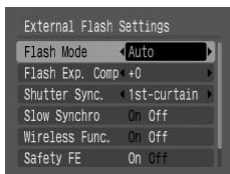

## Setting the Externally Mounted Flash

### 1 Display the Flash Settings screen.

1. Hold the  button down for more than one second.



### 2 Make settings.

1. Use the  or  button to select the items you wish to set.
2. Use the  or  button to set the item.
3. Press the  button.

- The available settings will vary depending on the flash in use. For details on settings, refer to the user guide included with your flash or Speedlite Transmitter.

### Speedlite 220EX/430EX Settings

\* Default setting.

Item	Options	Shooting mode			
		P	Tv	Av	M
Flash Mode	Auto	<input type="radio"/> *	<input type="radio"/> *	<input type="radio"/> *	—
	Manual	<input type="radio"/>	<input type="radio"/>	<input type="radio"/>	<input type="radio"/> *
Flash Exp. Comp <sup>1)</sup>	–3 to +3	<input type="radio"/>	<input type="radio"/>	<input type="radio"/>	—
Flash Output <sup>2)</sup>	1/64 to 1/1 (in 1/3 steps)	<input type="radio"/>	<input type="radio"/>	<input type="radio"/>	<input type="radio"/>
Shutter Sync.	1st-curtain	<input type="radio"/> *	<input type="radio"/> *	<input type="radio"/> *	<input type="radio"/> *
	2nd-curtain	<input type="radio"/>	<input type="radio"/>	<input type="radio"/>	<input type="radio"/>
Slow Synchro	On	<input type="radio"/>	<input type="radio"/> *	<input type="radio"/>	<input type="radio"/> *
	Off	<input type="radio"/> *	—	<input type="radio"/> *	—
Safety FE <sup>1)</sup>	On	<input type="radio"/> *	<input type="radio"/> *	<input type="radio"/> *	—
	Off	<input type="radio"/>	<input type="radio"/>	<input type="radio"/>	<input type="radio"/> *

 : Settings are retained even when the camera power is turned off.

1) This can be set when [Flash Mode] is set to [Auto].

2) This can be set when [Flash Mode] is set to [Manual].

## Speedlite 580EX II Settings

\* Default setting.

Item	Options	Shooting mode			
		P	Tv	Av	M
Flash Mode	Auto	○*	○*	○*	—
	Manual	○	○	○	○*
Flash Exp. Comp <sup>1)</sup>	-3 to +3	○	○	○	—
Flash Output <sup>2)</sup>	1/128 to 1/1 (in 1/3 steps)	○	○	○	○ <sup>5)</sup>
Shutter Sync.	1st-curtain	○*	○*	○*	○*
	2nd-curtain	○	○	○	○
	Hi-speed	○	○	○	○
Slow Synchro	On	○	○*	○	○*
	Off	○*	—	○*	—
Wireless Func. <sup>3)</sup>	On	○	○	○	○
	Off	○*	○*	○*	○*
Safety FE <sup>1)</sup>	On	○*	○*	○*	—
	Off	○	○	○	○*
Clear Flash Settings <sup>4)</sup>	Resets the settings to their default values.	○	○	○	○

 : Settings are retained even when the camera power is turned off.

- 1) This can be set when [Flash Mode] is set to [Auto].
- 2) This can be set when [Flash Mode] is set to [Manual].
- 3) Only [On] and [Off] can be set with the camera, and further settings are made with the flash.
- 4) [Slow Synchro] and [Safety FE] can also be returned to their default values using [Reset All] in the camera's  menu (p. 68).
- 5) When the flash unit is set to E-TTL automatic flash exposure compensation mode, the setting will be retained even if the camera is turned off.



You can also set in [Flash Control] in the  menu.





- [Flash Control] will not display when the flash is turned off. Before making flash settings, turn the flash on.
- When an external flash is mounted, you cannot make built-in flash settings.
- When adjusting flash exposure compensation with the camera, set the external flash's exposure compensation to [+0].
- If the external flash has been set to stroboscopic flash, the flash's set up menu cannot be selected (580EX II only).
- When [Wireless Func.] is set to [On], [Shutter Sync.] cannot be set to [2nd-curtain]. Even if you set [Shutter Sync.] to [2nd-curtain] with the camera, it will change to [1st-curtain].
- For continuous shooting, the flash can be in quick flash mode (pilot lamp lit green). In this case, light emission may be smaller than with full flash (pilot lamp lit red).
- The focus bracketing mode and the AEB mode cannot be used for flash photography. If the flash fires, only one image gets recorded.
- Flashes (especially high-voltage flashes) or flash accessories made by other manufacturers may override certain camera functions or cause a camera malfunction.



- The following functions can be used with a Speedlite 220EX, 430EX or 580EX II\*.
  - Auto Exposure (Use the E-TTL mode with a 430EX or 580EX II)
  - FE Lock (Not available in **M** mode or when [Flash Mode] is [Manual])
  - Shutter Sync. (1st-curtain/2nd-curtain) (2nd-curtain priority with Speedlite 430EX)
  - Slow Synchro
  - Flash Exp. Comp
  - Auto Zoom (Not available with the 220EX)
  - Manual flash
  - High-speed sync

\* You can also use 380EX, 420EX, 550EX and 580EX.

## Using an Externally Mounted Flash (Sold Separately)

### High-Power Flash HF-DC1

This flash is used to supplement the camera's built-in flash when the subject is too far away for proper illumination. Use the following procedures to affix the camera and High-Power Flash to the supporting bracket.

Please read the instructions accompanying the flash along with this explanation.

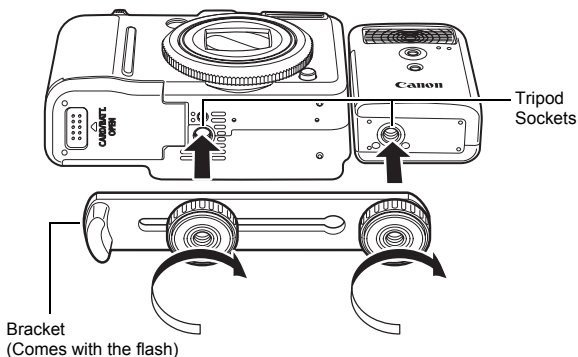

- The High-Power Flash will not fire under the following circumstances.
  - When shooting in **M** mode
  - When [Shutter Sync.] is on [2nd-curtain]
  - When [Flash Mode] is on [Manual]
- The flash charge time will lengthen as the battery charge gets weaker. Always set the power/mode switch to off when you finish using the flash.
- Be careful not to touch the flash window or sensor windows with your fingers while the flash is in use.

- The flash may fire if another flash is being used in close proximity.
- The High-Power Flash may not fire outdoors in daylight or when there are no reflective items.
- For continuous shooting, although the flash fires for the first shot, it does not fire for subsequent shots.
- Fasten the attachment screws securely so that they do not loosen. Failure to do so may lead to the dropping of the camera and flash resulting in damage to both.



- Before attaching the bracket to the flash, check that the lithium battery (CR123A or DL123) is installed.
- To illuminate the subjects properly, install the flash so that it is up against the side of the camera and parallel with the camera's front panel.
- A tripod can be used even when the flash is attached.

## Batteries

- Charge becomes Severely Limited

If the battery usage time has considerably diminished, wipe the battery terminals well with a dry cloth. The terminals may be dirty from fingerprints.

- Usage in Cold Temperatures

Get a spare generic lithium battery (CR123A or DL123). You are recommended to place the spare battery in your pocket to warm it up before switching it for the battery in the flash.

- Non-Use over Extended Periods

Leaving batteries in the High-Power Flash could allow the battery fluid to leak, damaging the product. Remove the batteries from the High-Power Flash and store them in a cool, dry place.

## Camera Care and Maintenance

Never use thinners, benzine, detergents or water to clean the camera. These substances may distort or damage the equipment.

### Camera Body

Gently wipe dirt off the camera body with a soft cloth or eyeglass lens wiper.

### Lens

First use a lens blower brush to remove dust and dirt, then remove any remaining dirt by wiping the lens lightly with a soft cloth.



Never use organic solvents on the camera body or lens. If dirt remains, contact the closest Canon Customer Support Help Desk as listed on the separate customer support list supplied with your camera.

### Viewfinder and LCD Monitor

Use a lens blower brush to remove dust and dirt. If necessary, gently wipe with a soft cloth or an eyeglass lens wiper to remove stubborn dirt.



Never rub or press strongly on the LCD monitor. These actions may damage it or lead to other problems.

## Specifications

All data is based on Canon's standard testing methods. Subject to change without notice.

### PowerShot G9 (W): Max. wide angle (T): Max. telephoto

Camera Effective Pixels	: Approx. 12.1 million
Image Sensor	: 1/1.7-inch type CCD (Total number of pixels: Approx. 12.4 million pixels)
Lens	: 7.4 (W) – 44.4 (T) mm (35mm film equivalent: 35 (W) – 210 (T) mm) f/2.8 (W) – f/4.8 (T)
Digital Zoom	: Approx. 4.0x (Up to approx. 24x in combination with the optical zoom)
Optical Viewfinder	: Real-image zoom viewfinder Picture coverage approx. 80% (representative value) Eyepoint: 15 mm (0.59 in.) Dioptric adjustment: –3.0 to +1.0 $\frac{1}{m}$ (dpt)
LCD Monitor	: 3.0-inch type, low-temperature polycrystalline silicon TFT color LCD, approx. 230,000 pixels, picture coverage rate 100%
AF System	: TTL autofocus AF lock and Manual focus are available AF frame mode: Face Detect/AiAF (9-point)/Center/FlexiZone
Focusing Range (From the end of the lens)	: 50 cm (1.6 ft.) – infinity Macro: 1 – 50 cm (W) (0.39 in. – 1.6 ft. (W)) Manual focus: 1 cm (0.39 in.) – infinity (W)/ 50 cm (1.6 ft.) – infinity (T) Sports mode: 1 m (3.3 ft.) – infinity (W)/ 3 m (9.8 ft.) – infinity (T) Kids&Pets: 1 m (3.3 ft.) – infinity (W/T)
Shutter	: Mechanical shutter and electronic shutter

Shutter Speeds	: 15 – 1/2500 sec. <ul style="list-style-type: none"> <li>• The shutter speed varies according to the shooting mode.</li> <li>• Slow shutter speeds of 15 to 1.3 sec. or slower operate with noise reduction.</li> </ul>
Image Stabilization	: Lens-shift type Continuous/Shoot Only*/Panning*/Off * Still images only
Metering System	: Evaluative*, Center-weighted average or Spot** * When [Face Detect] is selected, the brightness of the face is also evaluated. ** Center or AF-point
Exposure Compensation	: ±2.0 stops in 1/3-stop increments
ISO Speed (Standard Output)	: Auto*, High ISO Auto*, ISO 80/100/200/400/800/1600 * Camera automatically sets the optimal speed.
Sensitivity, Recommended Exposure Index)	
ND Filter (built-in)	: Light intensity reduction: 3 stops (Intensity becomes 1/8 of actual level)
White Balance	: Auto, Day Light, Cloudy, Tungsten, Fluorescent, Fluorescent H, Flash, Underwater, Custom 1 or Custom 2
Built-in Flash	: Auto, on, off Flash output compensation (±2.0 stops in 1/3-stop increments), Red-Eye Reduction, flash output settings (3 steps), FE Lock, Slow Synchro, 2nd-curtain Synchro and Safety FE are available.
Built-in Flash Range	: 30 cm – 4.0 m (12 in – 13 ft.) (W)/50 cm – 2.5 m (1.6 – 8.2 ft.) (T) (ISO speed: Auto)
External Flash	: Flash output compensation (±3.0 stops in 1/3-stop increments), red-eye reduction, flash output settings (19 levels*), FE Lock, Slow Synchro, 2nd-curtain Synchro, High-Speed Sync, Safety FE and wireless flash (On/Off only) are available. * 22 levels with 580EX II

---

Terminals for External Flash	: Hot shoe flash-sync contacts Use of the following external flashes is recommended: Canon Speedlite 220EX, 430EX, 580EX and 580EX II.
Shooting Modes	: Auto Creative zone: <b>P</b> Program, <b>Tv</b> Shutter-speed priority, <b>Av</b> Aperture priority, <b>M</b> Manual, <b>C1</b> Custom 1, <b>C2</b> Custom 2 Image zone: Special Scene*, Stitch Assist, Movie** * Portrait, Landscape, Night Scene, Sports, Night Snapshot, Kids&Pets, Indoor, Foliage, Snow, Beach, Fireworks, Aquarium, Underwater, ISO 3200, Color Accent and Color Swap. ** Standard, High Resolution, Compact, Color Accent, Color Swap and Time Lapse.
Continuous Shooting	: Approx. 1.5 shots/sec. (Large/Fine mode) Approx. 0.7 shots/sec. (Continuous Shooting AF, Large/Fine mode) Approx. 0.8 shots/sec. (Continuous Shooting LV, Large/Fine mode)
Self-timer	: Activates shutter after an approx. 10-sec./ approx. 2-sec. delay, Custom Timer
Remote Shooting	: Shooting possible when connected to a computer using supplied software.
Recording Media	: SD memory card/SDHC memory card/ MultiMediaCard/MMCplus card/HC MMCplus card
File Format	: Design rule for camera file system and DPOF compliant

---



Data Type	: Still images: Exif 2.2 (JPEG)* or RAW (CR2)
	: Movies: AVI (Image data: Motion JPEG; Audio data: WAVE (monaural))
	: Sound Memo and Sound Recorder: WAVE (monaural)
	* This digital camera supports Exif 2.2 (also called "Exif Print"). Exif Print is a standard for enhancing the communication between digital cameras and printers. By connecting to an Exif Print-compliant printer, the camera's image data at the time of shooting is used and optimized, yielding extremely high quality prints.

Compression	: Superfine, Fine, Normal
-------------	---------------------------

Number of (Still images)	: Large	: 4000 × 3000 pixels
Recording	Medium 1	: 3264 × 2448 pixels
Pixels	Medium 2	: 2592 × 1944 pixels
	Medium 3	: 1600 × 1200 pixels
	Small	: 640 × 480 pixels
	Widescreen	: 4000 × 2248 pixels
	RAW	: 4000 × 3000 pixels
	(Movies)	: Standard, Color Accent and Color Swap
	: 640 × 480 pixels (30 frames/sec.)	
	: 640 × 480 pixels (30 frames/sec. LP)	
	: 320 × 240 pixels (30 frames/sec.)	
	Recording can continue until the memory card is full* (can record up to a maximum of 4 GB at one time)**	
	High Resolution: 1024 × 768 pixels (15 frames/sec.)	
	Recording can continue until the memory card is full* (can record up to a maximum of 4 GB at one time)**	
	Compact: 160 × 120 (15 frames/sec.)	
	: Maximum recording length per clip: 3 min.	
	Time Lapse	
	640 × 480 pixels (1 frame/sec. (shooting interval: 1 sec.), 0.5 frames/sec. (shooting interval: 2 sec.))	
	(15 frames/sec. during playback)	
	Can record for 2 hours.	

- \* Using super high-speed memory cards (SDC- 512 MSH recommended).
- \*\* Even if the clip size has not reached 4 GB, recording will stop at the moment the clip length reaches 1 hour. Depending on the volume and data writing speed of the memory card, recording will stop after one hour of continuous recording even if the recorded data volume has not reached 4 GB.

Audio	: Quantization Bit Rate: 16 bit Sampling Rate Sound Memos, Movie (Compact): 11.025 kHz Movie (other than Compact): 44.100 kHz Sound Recorder: 11.025 kHz, 22.050 kHz, 44.100 kHz
Playback Modes	: Single (histogram displayable), Index (9 thumbnail images)/Magnified (approx. 10x max. in LCD monitor, forward or reverse selection through magnified images possible), Red-Eye Correction, My Category, Jump (it is possible to jump to every tenth or hundredth image, to the first image of each shooting date, to movies or to the first image in each category or folder. In index playback mode, it displays 9 images at once.), Slide Show, My Colors, Sound memos (it is possible to record and playback up to 1 min.), Movie (editing/slowmotion playback possible), Sound recorder (up to 2 hours. of recording/playback of sound only), Resize
Direct Print	: PictBridge compliant, and Canon Direct Print and Bubble Jet Direct compatible
My Camera settings	: Start-up image, start-up sound, operation sound, self-timer sound, and shutter sound
Interface	: USB 2.0 Hi-Speed (mini-B), PTP (Picture Transfer Protocol) Audio/Video output (NTSC or PAL selectable, monaural audio)
Communication Settings	: MTP, PTP

Power Source	: Battery Pack NB-2LH (Rechargeable lithiumion battery) AC Adapter Kit ACK-DC20
Operating Temperatures	: 0 – 40 °C (32 – 104 °F)
Operating Humidity	: 10 – 90 %
Dimensions (excluding protrusions)	: 106.4 × 71.9 × 42.5 mm (4.19 × 2.83 × 1.67 in.)
Weight (camera body only)	: Approx. 320 g (11.29 oz.)

### **Battery Capacity (Battery Pack NB-2LH (Fully charged))**

Number of Images Shot		Playback Time
LCD Monitor On (Based on the CIPA standard)	LCD Monitor Off	
Approx. 240 images	Approx. 600 images	Approx. 7 hours

- The actual figures will vary according to the shooting conditions and settings.
- Movie data is excluded.
- At low temperatures, the battery performance may diminish and the low battery icon may appear very rapidly. In these circumstances, the performance can be improved by warming the battery in a pocket before use.

## Test Conditions

Shooting: Normal temperature ( $23^{\circ}\text{C} \pm 2^{\circ}\text{C}/73^{\circ}\text{F} \pm 3.6^{\circ}\text{F}$ ), normal relative humidity ( $50\% \pm 20\%$ ), alternating wide angle end and telephoto end shots at 30 second intervals with the flash fired once every two shots and the camera power turned off after every tenth shot. Power is left off for a sufficient amount of time\*, then the power is turned back on and the testing procedure is repeated.

- A Canon-brand memory card is used.

- \* Until the battery returns to normal temperature



















Playback: Normal temperature ( $23^{\circ}\text{C} \pm 2^{\circ}\text{C}/73^{\circ}\text{F} \pm 3.6^{\circ}\text{F}$ ), normal relative humidity ( $50\% \pm 20\%$ ), continuous playback at 3 seconds per image.



See *Battery Handling* (p. 229).

## Memory Cards and Estimated Capacities

: Card included with the camera













Recording Pixels	Compression	32 MB	SDC-128M	SDC-512MSH
<b>L</b> (Large) 4000 × 3000 pixels		5	23	91
		9	39	155
		20	82	321
<b>M1</b> (Medium 1) 3264 × 2448 pixels		8	35	139
		14	59	231
		30	123	479
<b>M2</b> (Medium 2) 2592 × 1944 pixels		11	49	190
		21	87	339
		42	173	671
<b>M3</b> (Medium 3) 1600 × 1200 pixels		30	121	471
		53	217	839
		102	411	1590
<b>S</b> (Small) 640 × 480 pixels		114	460	1777
		177	711	2747
		278	1118	4317
<b>W</b> (Widescreen) 4000 × 2248 pixels		7	31	122
		12	53	206
		27	109	425
<b>RAW</b> (RAW) 4000 × 3000 pixels	—	1	6	27
<b>RAW</b> +  4000 × 3000 pixels	—	1	5	23

: Capable of smooth continuous shooting (p. 111) (When card has been formatted with a low level format).

This reflects standard shooting criteria established by Canon. Actual results may vary according to the subject and shooting conditions.



## Movie

: Card included with the camera

		Recording Pixels/ Frame Rate	32 MB	SDC-128M	SDC-512MSH
 Standard		640 × 480 pixels 30 frames/sec.	14 sec.	1 min. 1 sec.	3 min. 57 sec.
 Color Accent		640 × 480 pixels 30 frames/sec., LP	28 sec.	1 min. 56 sec.	7 min. 30 sec.
 Color Swap		320 × 240 pixels 30 frames/sec.	40 sec.	2 min. 42 sec.	10 min. 29 sec.
 High Resolution		1024 × 768 pixels 15 frames/sec.	14 sec.	1 min. 1 sec.	3 min. 57 sec.
 Compact		160 × 120 pixels 15 frames/sec.	3 min. 15 sec.	13 min. 2 sec.	50 min. 21 sec.
 Time Lapse		640 × 480 pixels	7 min. 45 sec.	31 min. 45 sec.	2 hrs. 3 min. 30 sec.
			15 min. 30 sec.	1 hr. 3 min. 30 sec.	4 hrs. 7 min.

\* 1 frame/sec. (shooting interval: 1 sec.)

\*\* 0.5 frames/sec. (shooting interval: 2 sec.)





- Maximum movie clip length at : 3 min. The figures indicate the maximum continuous recording time.
- As  plays back at 15 frames/sec., the recording time and the playback time will differ.

## Estimated Sound Recorder File Sizes and Recording Times













: Card included with the camera

	Sound Size	32 MB	SDC-128M	SDC-512MSH
11.025 kHz	22 KB/sec.	24 min. 13 sec.	1 hr. 36 min. 59 sec.	6 hrs. 14 min. 16 sec.
22.050 kHz	44 KB/sec.	12 min. 6 sec.	48 min. 30 sec.	3 hrs. 7 min. 8 sec.
44.100 kHz	88 KB/sec.	6 min. 3 sec.	24 min. 15 sec.	1 hr. 33 min. 34 sec.

## Image Data Sizes (Estimated)

Recording Pixels	Compression*		
			
<b>L</b> 4000 × 3000 pixels	5208 KB	3084 KB	1474 KB
<b>M1</b> 3264 × 2448 pixels	3436 KB	2060 KB	980 KB
<b>M2</b> 2592 × 1944 pixels	2503 KB	1395 KB	695 KB
<b>M3</b> 1600 × 1200 pixels	1002 KB	558 KB	278 KB
<b>S</b> 640 × 480 pixels	249 KB	150 KB	84 KB
<b>WV</b> 4000 × 2248 pixels	3903 KB	2311 KB	1105 KB
<b>RAW</b> 4000 × 3000 pixels	17076 KB		
<b>RAW</b> +  4000 × 3000 pixels	20160 KB		

\* Not available for RAW and RAW+ .

	Recording Pixels/Frame Rate	File Size
 Standard	 640 × 480 pixels 30 frames/sec.	1963 KB/sec.
 Color Accent	 640 × 480 pixels 30 frames/sec., LP	1003 KB/sec.
 Color Swap	 320 × 240 pixels 30 frames/sec.	703 KB/sec.
 High Resolution	 1024 × 768 pixels 15 frames/sec.	1963 KB/sec.
 Compact	 160 × 120 pixels 15 frames/sec.	131 KB/sec.
 Time Lapse	 1"*	64 KB/sec.
	 2" **	32 KB/sec.

\* 1 frame/sec. (shooting interval: 1 sec.)

\*\* 0.5 frames/sec (shooting interval: 2 sec.)

## MultiMediaCard

Interface	Compatible with MultiMediaCard standards
Dimensions	32.0 × 24.0 × 1.4 mm (1.3 × 0.9 × 0.06 in.)
Weight	Approx. 1.5 g (0.05 oz.)

## SD Memory Card

Interface	Compatible with SD memory card standards
Dimensions	32.0 × 24.0 × 2.1 mm (1.3 × 0.9 × 0.1 in.)
Weight	Approx. 2 g (0.07 oz.)

## Battery Pack NB-2LH

Type	Rechargeable lithium-ion battery
Nominal Voltage	7.4 V DC
Typical Capacity	720 mAh
Cycle Life	Approx. 300 times
Operating Temperatures	0 – 40°C (32 – 104°F)
Dimensions	33.3 × 45.2 × 16.2 mm (1.31 × 1.78 × 0.64 in.)
Weight	Approx. 43 g (1.52 oz.)

## Battery Charger CB-2LW/CB-2LWE

Rated Input	100 – 240 V AC (50/60 Hz) 0.12 A (100 V) – 0.065 A (240 V)
Rated Output	8.4 V DC, 0.55 A
Charging Time	Approx. 1 hr. 45 min. (when charging NB-2LH)
Operating Temperatures	0 – 40°C (32 – 104°F)
Dimensions	56.0 × 91.0 × 22.5 mm (2.2 × 3.6 × 0.9 in.)
Weight	Approx. 68 g (2.4 oz.) (CB-2LW) Approx. 61 g (2.2 oz.) (CB-2LWE) (excluding power cord)

## Compact Power Adapter CA-PS700

(Included with the separately sold AC Adapter Kit ACK-DC20)

Rated Input	100 – 240 V AC (50/ 60 Hz)
Rated Output	7.4 V DC, 2.0 A
Operating Temperatures	0 – 40°C (32 – 104°F)
Dimensions	45.0 × 112.0 × 29.0 mm (1.77 × 4.41 × 1.14 in.) (body only)
Weight	Approx. 185 g (6.53 oz.) (excluding power cord)



**Car Battery Charger CBC-NB2 (Sold Separately)**

Rated Input	12 V / 24 V DC
Rated Output	8.4 V DC, 0.55 A
Charging Time	Approx. 1 hr. 30 min. (when charging NB-2LH)
Operating Temperatures	0 – 40°C (32 – 104°F)
Dimensions	91.0 × 29.5 × 56.0 mm (3.58 × 1.16 × 2.20 in.)
Weight	Approx. 145 g (5.11 oz.) (excluding power cord)

**Wide Converter WC-DC58B (Sold Separately)**

Magnification	0.75x
Focal Length* <sup>1</sup>	26.3 mm (35mm film equivalent)
Focusing Range* <sup>1</sup>	30 cm (12 in.) – infinity* <sup>2</sup>
Thread Diameter	58 mm standard filter thread* <sup>3</sup>
Dimensions Diameter × Length	97.0 × 49.5 mm (3.82 × 1.95 in.)
Weight	Approx. 365 g (12.9 oz.)

**Tele-converter TC-DC58C (Sold Separately)**

Magnification	2x
Focal Length* <sup>4</sup>	420 mm (35mm film equivalent)
Focusing Range* <sup>4</sup>	Approx. 1.8 m (5.9 ft.) – infinity* <sup>2</sup>
Thread Diameter	58 mm standard filter thread* <sup>3</sup>
Dimensions Diameter × Length	80.0 × 81.3 mm (3.15 × 3.20 in.)
Weight	Approx. 335 g (11.8 oz.)

**Conversion Lens Adapter LA-DC58H (Sold Separately)**

Thread Diameter	58 mm standard filter thread
Dimensions Diameter × Length	63.5 × 50.6 mm (2.50 × 1.99 in.)
Weight	Approx. 25 g

(W) : Max. wide angle (T) : Max. telephoto

\*1 When mounted on PowerShot G9 (Max. wide angle)

\*2 From front of the mounted conversion lens during normal shooting.

\*3 Conversion Lens Adapter LA-DC58H is required when mounted on PowerShot G9

\*4 When mounted on PowerShot G9 (Max. telephoto)

# INDEX

## Numerics

1st-curtain .....	151
2nd-curtain .....	151
3:2 Guide .....	57

## A

AC Adapter Kit .....	234, 262
ACK-DC20 .....	234
Add Frame .....	181
AE Lock .....	128
AEB Mode .....	131
AF Frame .....	59, 116
AF Lock .....	123
AF Mode .....	115
AF-assist Beam .....	40
Aperture Value .....	96, 98
Audio .....	108
AUTO	
Shooting .....	16
Auto ISO Shift .....	133
Auto Rotate .....	155

## B

Battery	
Charging .....	10
Handling .....	229
Installing .....	11

## C

Car Battery Charger .....	235
Category	
My Category (Playback Mode)	
.....	167
CBC-NB2 .....	235
Clock .....	56

Color Accent Mode .....	144
Color Swap Mode .....	145
Components Guide .....	40
Compression .....	78
Continuous Shooting .....	111
Control Dial .....	43
Converter .....	241
Custom .....	109
Custom Display .....	58

## D

Date and Time .....	14
Digital Tele-Converter .....	71
Digital Zoom .....	71
Direct Transfer .....	31
Display Language .....	15
Distance Units .....	52
Downloading Images to a Computer	
.....	26

## E

Erasing .....	195
Single Image .....	23
Exposure Compensation .....	135
Externally Mounted Flash	
.....	242, 249

## F

Face Detect .....	116, 119
FE Lock .....	130
File Number .....	158
Flash .....	74
Flash Adjustment .....	149
Flash Adjustment Settings .....	148
Flash Output .....	150
Focus .....	86, 116

- Focus Check ..... 86
  - Focus Lock ..... 123
  - Focus Settings ..... 115
  - Focus-BKT Mode ..... 127
  - Folder ..... 156
  - Format ..... 69
  - Frame Rate ..... 106
  - FUNC. Menu ..... 48
- G**
- Grid Lines ..... 57
- H**
- HF-DC1 ..... 249
  - High-Power Flash ..... 249
  - Histogram ..... 64
- I**
- Image Data Sizes (Estimated) 261
  - Image Destination ..... 156
  - Image Type ..... 80
  - Index Playback ..... 161
  - Indicators ..... 44
  - Information Displayed on the LCD
  - Monitor ..... 59
  - IS Mode ..... 82
  - ISO Speed ..... 84
- L**
- LA-DC58H ..... 237
  - LCD Monitor
    - Brightness ..... 56
    - Playback Information ..... 61
    - Shooting Information ..... 59
    - Using the LCD Monitor ..... 55
  - LCD monitor
    - Night Display ..... 57
  - Lens ..... 236
    - Conversion Lens Adapter
      - ..... 237, 238
      - Tele-converter ..... 237
      - Wide Converter ..... 237
- M**
- Macro ..... 75
  - Magnifying ..... 160
  - Manual Focus ..... 124
  - Memory Card
    - Estimated Capacities ..... 259
    - Handling ..... 232
    - Inserting ..... 12
  - Menu
    - FUNC. Menu ..... 48
    - Play Menu ..... 50
    - Print Menu ..... 50
    - Rec. Menu ..... 48
    - Set up Menu ..... 51
  - Menu List ..... 48
  - Messages ..... 220
  - Metering Mode ..... 136
  - MF-Point Zoom ..... 49, 124
  - Microphone ..... 108
  - Mode Dial ..... 88
  - Movie
    - Editing ..... 172
    - Shooting ..... 20, 102
    - Viewing ..... 22
  - Mute ..... 51
  - My Camera Settings ..... 207
    - Registering ..... 208
  - My Category ..... 167
  - My Colors ..... 140
  - My Colors Effects ..... 185
- N**
- ND Filter ..... 132
- O**
- Optical Zoom ..... 70

Optional Accessories .....	36
Overexposure Warning .....	64

**P**

Panorama .....	100
Play Menu .....	50
Power Saving .....	52
Power Saving Function .....	45
Print Menu .....	50
Print Settings (DPOF) .....	198
Print/Share Button .....	24, 31
Printing .....	24
Program AE .....	93
Program Shift .....	129
Protect .....	192

**R**

Rec. Menu .....	48
Recording Function .....	108
Recording Pixels .....	78, 106
Red-Eye Correction .....	180
Red-Eye Reduction .....	113
Reset All .....	68
Resize .....	187
Review .....	49
Reviewing .....	18
Rotate .....	174

**S**

Safety FE .....	152
Safety MF .....	126
Safety Shift .....	96, 97
Safety Zoom .....	73
Self-Timer .....	76
Set up Menu .....	51
Shooting Mode .....	89
Functions Available .....	270
Shortcut .....	153
Shutter Speed .....	94, 98
Slide Shows .....	176

Slow Synchro .....	114
Sound Memos .....	189
Sound Recorder .....	190
Spot AE Point Frame .....	59
Still Image	
Shooting .....	16
Viewing .....	19
Stitch Assist .....	100
System Requirements .....	26

**T**

TC-DC58C .....	237
Telephoto .....	70
Time Zone .....	65
Transfer Settings (DPOF) .....	203

**W**

WC-DC58B .....	237
White Balance .....	137
Wide Angle .....	70
Wind Filter .....	108
World Clock .....	65

**FCC Notice**

(Digital Camera, Model PC1250 Systems)

This device complies with Part 15 of the FCC Rules. Operation is subject to the following two conditions;

- (1) this device may not cause harmful interference, and
- (2) this device must accept any interference received, including interference that may cause undesired operation.

Note: This equipment has been tested and found to comply with the limits for Class B digital devices, pursuant to Part 15 of the FCC rules. These limits are designed to provide reasonable protection against harmful interference in a residential installation. This equipment generates, uses and can radiate radio frequency energy and, if not installed and used in accordance with the instructions, may cause harmful interference to radio communications. However, there is no guarantee that interference will not occur in a particular installation. If this equipment does cause harmful interference to radio or television reception, which can be determined by turning the equipment off and on, the user is encouraged to try to correct the interference by one or more of the following measures:

- Reorient or relocate the receiving antenna.
- Increase the separation between the equipment and receiver.
- Connect the equipment into an outlet on a circuit different from that to which the receiver is connected.
- Consult the dealer or an experienced radio/TV technician for help.

The cable with the ferrite core provided with the digital camera must be used with this equipment in order to comply with Class B limits in Subpart B of Part 15 of the FCC rules.

Do not make any changes or modifications to the equipment unless otherwise specified in the manual. If such changes or modifications should be made, you could be required to stop operation of the equipment.

Canon U.S.A., Inc.

One Canon Plaza, Lake Success, NY 11042, U.S.A.

Tel No. (516) 328-5600

**Canadian Radio Interference Regulations**

This Class B digital apparatus complies with Canadian ICES-003.

**Réglementation canadienne sur les interférences radio**

Cet appareil numérique de la classe B est conforme à la norme NMB-003 du Canada.

**Battery Charger CB-2LW**

This product is not intended to be serviced. Should the product cease to function in its intended manner, it should be returned to the manufacturer or be discarded.

This power unit is intended to be correctly orientated in a vertical or floor mount position.

**IMPORTANT SAFETY INSTRUCTIONS-SAVE THESE INSTRUCTIONS.****DANGER-TO REDUCE THE RISK OF FIRE OR ELECTRIC SHOCK, CAREFULLY FOLLOW THESE INSTRUCTIONS.**

For connection to a supply not in the U.S.A., use an attachment plug adapter of the proper configuration for the power outlet.

This battery charger is for exclusive use with Battery Pack NB-2LH (0.72 Ah). There is a danger of explosion if other battery packs are used.

**For CA, USA only**

Included lithium battery contains Perchlorate Material - special handling may apply.

See [www.dtsc.ca.gov/hazardouswaste/perchlorate/](http://www.dtsc.ca.gov/hazardouswaste/perchlorate/) for details.

## **Disclaimer**

- While every effort has been made to ensure that the information contained in this guide is accurate and complete, no liability can be accepted for any errors or omissions.
- Canon reserves the right to change the specifications of the hardware and software described herein at anytime without prior notice.
- No part of this guide may be reproduced, transmitted, transcribed, stored in a retrieval system, or translated into any language in any form, by any means, without the prior written permission of Canon.
- Canon makes no warranties for damages resulting from corrupted or lost data due to a mistaken operation or malfunction of the camera, the software, SD memory cards (SD cards), personal computers, peripheral devices, or use of non-Canon SD cards.

## **Trademark Acknowledgments**

- Microsoft, Windows Vista and the Windows Vista logo are trademarks or registered trademarks of Microsoft Corporation in the United States and/or other countries.
- Macintosh, the Mac logo, Quick Time and the QuickTime logo are trademarks of Apple Inc., registered in the U.S. and other countries.
- The SDHC logo is a trademark.







		M	Av	Tv	P		AUTO						
AF Frame (p. 116)	Face Detect	○	○	○	○	—	○	—	—	—	—	—	—
	AiAF (9-point)	○	○	○	○	—	○	○	○	○	○	○	○
	Center	○	○	○	○	○	○	—	—	—	—	—	—
	FlexiZone	○ <sup>5)</sup>	○ <sup>5)</sup>	○ <sup>5)</sup>	○ <sup>5)</sup>	—	—	—	—	—	—	—	—
Digital Zoom (p. 70)	Standard	○	○	○	○	—	○	○	—	—	—	—	—
	Digital Tele-converter	○	○	○	○	—	○	—	—	—	—	—	—
Flash Control (Built-in)	Flash Mode (p. 148)	Auto	—	○	○	○	○	—	—	—	—	—	—
		Manual	○	○	○	—	—	—	—	—	—	—	—
	Flash Output (p. 150)		○	○	○	—	—	—	—	—	—	—	—
	Flash Exp. Comp (p. 149)		—	○	○	○	○	—	—	—	—	—	—
	Shutter Sync. (2nd curtain) (p. 151)		○	○	○	○	—	—	—	—	—	—	—
	Slow Synchro (p. 114)		○ <sup>6)</sup>	○	○ <sup>6)</sup>	○	○	—	—	—	—	—	—
Safety FE (p. 152)		—	○	○	○	—	—	—	—	—	—	—	
Red-Eye (p. 113)		○	○	○	○	○	○	—	—	—	—	—	
Spot AE Point (p. 136)	Center	○	○	○	○	—	—	—	—	—	—	—	
	AF Point	○	○	○	○	—	—	—	—	—	—	—	
Safety Shift (pp. 96, 97)		—	○	○	—	—	—	—	—	—	—	—	
Auto ISO Shift (p. 133)	button / On	—	○	—	○	—	○	—	—	—	—	—	
	Manual	○	○	○	○	○	○	○	○	○	○	○	
MF-Point Zoom (p. 49)		○	○	○	○	—	—	—	—	—	—	—	
Safety MF (p. 126)		○	○	○	○	—	—	○	○	○	○	○	
AF Mode <sup>7)</sup> (p. 115)	Continuous	○	○	○	○	○	○	—	—	—	—	—	
	Single	○	○	○	○	○	○	○	○	○	○	○	
AF-assist Beam (p. 49)		○	○	○	○	○	○	○	○	○	○	○	
Review (Rec. review) (p. 18)		○	○	○	○	○	○	—	—	—	—	—	
Review Info (p. 49)	Off	○	○	○	○	○	○	—	—	—	—	—	
	Detailed/Focus Check	○	○	○	○	—	○	—	—	—	—	—	
Auto Category (p. 49)		○	○	○	○	○	○	○	○	○	○	○	
IS Mode (p. 82)	Continuous	○	○	○	○	○	○	○	○	○	○	○	
	Shoot Only / Panning	○	○	○	○	○	○	—	—	—	—	—	
Custom Settings (Saved in the C1/C2) (p. 109)		○	○	○	○	—	—	—	—	—	—	—	

○ : Setting available or optimum value is automatically set by the camera. As a rule, with the , only the first image is available.

— : Not available.

: The settings are retained even when the camera power is turned off.

- 1) Fix to ISO 3200.
- 2) Set to Continuous Shooting LV when Manual Focus or Fireworks is selected.
- 3) Widescreen is not available.
- 4) Fix to M3 (1600 × 1200)
- 5) Changes settings to [Center] if the LCD monitor is turned off.
- 6) Always set to on.
- 7) Single is only available when AiAF (9-points) is selected.

