

EXILIM

E

Digital Camera

EX-P505

User's Guide

Thank you for purchasing this CASIO product.

- Before using it, be sure to read the precautions contained in this User's Guide.
- Keep the User's Guide in a safe place for future reference.
- For the most up-to-date information about this product, visit the official EXILIM Website at <http://www.exilim.com/>.

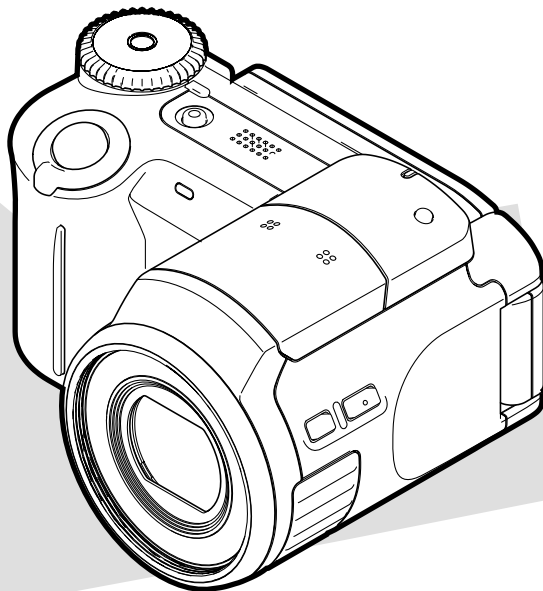

K831PCM1DMX

CASIO®

INTRODUCTION

Unpacking

Check to make sure that all of the items shown below are included with your camera. If something is missing, contact your dealer as soon as possible.

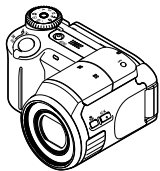

Camera

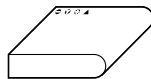

Rechargeable Lithium Ion
Battery (NP-40)

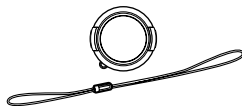

Lens cap/cap holder



Lens hood

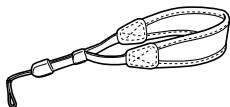

Strap



CD-ROMs (2)

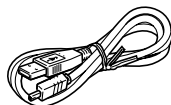

USB Cable

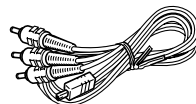

AV Cable

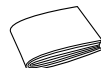

Basic Reference

- Note that the shape of the rapid charger depends on the area where you purchased the camera.

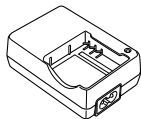

Rapid Charger (BC-30L)
(Power Cord Type)

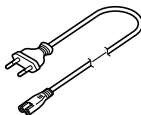

AC Power Cord *

* The shape of the AC power
cord plug varies according to
country or geographic area.

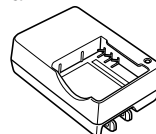

Rapid Charger (BC-30L)
(Plug-in Type)

Contents

2 INTRODUCTION

Unpacking	2
Features	9
Precautions	12
General Precautions	12

16 QUICK START GUIDE

First, charge the battery!	16
To configure display language and clock settings	18
To record an image	19
To view a recorded image	20
To delete an image	20
To turn off the camera	21

22 GETTING READY

About This Manual	22
General Guide	23
Using the Monitor Screen	26
Monitor Screen Contents	28
REC Modes	28
PLAY Mode	33
Changing the Contents of the Monitor Screen	34
Attaching the Strap	36
Using the Lens Cap	37
Power Requirements	37
Using the Rapid Charger	37
To load the battery	42
To replace the battery	46
Power Supply Precautions	46
Using AC Power	49
Turning the Camera On and Off	51
Configuring Power Saving Settings	52
Using the On-screen Menus	53
Configuring Display Language and Clock Settings ...	56
To configure display language and clock settings	57

59 BASIC IMAGE RECORDING

Recording an Image	59
Specifying the Recording Mode	59
Aiming the Camera	61
Recording an Image	62
Using Zoom	66
Optical Zoom	66
Digital Zoom	67
Using the Flash	69
Flash Unit Status	72
Changing the Flash Intensity Setting	72
Using Flash Assist	73
Using the Self-timer	75
Specifying Image Size	77
Specifying Image Quality	79

80 OTHER RECORDING FUNCTIONS

Selecting the Focus Mode	80
Using Auto Focus	81
Using the Macro Mode	84
Using Pan Focus	85
Using the Infinity Mode	85
Using Manual Focus	86
Using Focus Lock	87
Exposure Compensation (EV Shift)	88
Using the Built-in ND Filter	90
To turn the ND filter on and off	90
Adjusting White Balance	91
Configuring the White Balance Setting Manually	92
Specifying the Exposure Mode	94
Using Aperture Priority AE	94
Using Shutter Speed Priority AE	96
Setting Exposure Settings Manually	97
Using Manual Assist On-screen Guidance	99
Exposure Mode Recording Precautions	100
Using the BEST SHOT Mode	100
Creating Your Own BEST SHOT Setup	102
To delete a BEST SHOT user setup	104
Recording a Movie	104
Specifying Movie Image Quality	105
Recording a Standard Movie (Movie Mode)	106
Recording Past Action (Past Movie Mode)	107
Recording a Short Movie (Short Movie Mode)	108

INTRODUCTION

Instant Movie Setups (MOVIE BEST SHOT Mode)	111
Creating Your Own MOVIE BEST SHOT Setup	112
Recording Audio	114
Adding Audio to a Snapshot	114
Using the Histogram	116
REC Mode Camera Settings	118
Specifying ISO Sensitivity	119
Selecting the Metering Mode	120
Using the Filter Function	121
Specifying Outline Sharpness	121
Specifying Color Saturation	122
Specifying Contrast	122
Turning the On-screen Grid On and Off	123
Turning Image Review On and Off	123
Using Icon Help	124
Assigning Functions to the [◀] and [▶] Keys	125
Specifying Power On Default Settings	125
Resetting the Camera	127
Using the Shortcut Menu (EX Menu)	128
Installing the Lens Hood and a Lens Filter	129

130 PLAYBACK

Basic Playback Operation	130
Playing an Audio Snapshot	131
Zooming the Display Image	132
Resizing an Image	133
Cropping an Image	135
Playing and Editing a Movie	136
Playing a Movie	136
Editing a Movie	138
Capturing a Still Image from a Movie (MOTION PRINT)	141
Displaying the 9-image View	143
Playing a Slideshow	144
Rotating the Display Image	146
Adding Audio to a Snapshot	147
To re-record audio	148
Displaying Camera Images on a TV Screen	149
Selecting the Video Input System	151

152 DELETING FILES

Deleting a Single File	152
Deleting All Files	153

INTRODUCTION

154 FILE MANAGEMENT

Folders	154
Memory Folders and Files	154
Protecting Files	155
To protect a single file	155
To protect all files in memory	156

157 OTHER SETTINGS

Configuring Sound Settings	157
To configure sound settings	157
To set the confirmation tone volume level	158
To set the audio volume level for movie and audio snapshot playback	158
Specifying the File Name Serial Number Generation Method	159
Setting the Clock	159
To select your Home Time zone	160
To set the current time and date	161
Changing the Date Format	161
Using World Time	162
To display the World Time screen	162
To configure World Time settings	162
Changing the Display Language	163
Changing the USB Port Protocol	164
Formatting Built-in Memory	165

166 USING A MEMORY CARD

Using a Memory Card	167
To insert a memory card into the camera	167
To replace the memory card	168
Formatting a Memory Card	169
Copying Files	170
To copy all the files in built-in memory to a memory card	171
To copy a specific file from a memory card to built-in memory	171

173 PRINTING IMAGES

DPOF	174
To configure print settings for a single image	175
To configure print settings for all images	176
Using PictBridge	177
Date Printing	181
PRINT Image Matching III	182
Exif Print	182

183 VIEWING IMAGES ON A COMPUTER

Using the Camera with a Windows Computer	183
Using the Camera with a Macintosh Computer	191

INTRODUCTION

Using a Memory Card to Transfer Images to a Computer	196
Memory Data	197
DCF Protocol	197
Memory Folder Structure	197
Image Files Supported by the Camera	199

200 USING THE CAMERA WITH A COMPUTER

Using the Camera with a Windows Computer	200
About the bundled CD-ROM	200
Computer System Requirements	202
Managing Images on a PC	204
Retouching, Reorienting, and Printing a Snapshot	207
Playing a Movie	209
Editing a Movie	212
Viewing User Documentation (PDF Files)	213
User Registration	214
Exiting the Menu Application	214
Using the Camera with a Macintosh Computer	215
About the bundled CD-ROM	215
Computer System Requirements	216
Managing Images on a Macintosh	217
Viewing User Documentation (PDF Files)	218
To register as a camera user	218

219 APPENDIX

Menu Reference	219
Indicator Lamp Reference	221
Troubleshooting Guide	224
If you have problems installing the USB driver...	228
Display Messages	229
Specifications	231

INTRODUCTION

»» IMPORTANT! ««

- The contents of this manual are subject to change without notice.
- CASIO COMPUTER CO., LTD. assumes no responsibility for any damage or loss resulting from the use of this manual.
- CASIO COMPUTER CO., LTD. assumes no responsibility for any loss or claims by third parties which may arise through the use of the EX-P505.
- CASIO COMPUTER CO., LTD. shall not be held liable for any damages or losses suffered by you or any third party due to the use of Photo Loader and/or Photohands.
- CASIO COMPUTER CO., LTD. assumes no responsibility for any damage or loss caused by deletion of data as a result of malfunction, repairs, or battery replacement. Be sure to back up all important data on other media to protect against its loss.
- Note that the example screens and product illustrations shown in this User's Guide may differ somewhat by the screens and configuration of the actual camera.
- *The SD logo is a registered trademark.*
- *Windows, Internet Explorer, Windows Media, and DirectX are registered trademarks of Microsoft Corporation.*

- *Macintosh is a registered trademark of Apple Computer, Inc.*
- *MultiMediaCard is a trademark of Infineon Technologies AG of Germany, and licensed to the MultiMediaCard Association (MMCA).*
- *Adobe and Reader are either registered trademarks or trademarks of Adobe Systems Incorporated in the United States and/or other countries.*
- *Ulead is a trademark of Ulead Systems, Inc.*
- *Other company, product and service names used herein may also be trademarks or service marks of others.*
- *Photo Loader and Photohands are the property of CASIO COMPUTER CO., LTD. Except as stipulated above, all copyrights and other related rights to these applications revert to CASIO COMPUTER CO., LTD.*

INTRODUCTION

■ LCD Panel

The LCD panel is a product of the latest LCD manufacturing technology that provides a pixel yield of 99.99%. This means that less than 0.01% of the total pixels are defective (they do not turn on or always remain turned on).

■ Copyright Restrictions

Except for the purposes of your own personal enjoyment, unauthorized copying of snapshot files, movie files, and audio files violates copyright laws and international contracts.

Distribution to third parties of such files over the Internet without permission of the copyright holder, whether for profit or for free, violates copyright laws and international contracts.

Features

- 5.0 million effective pixels
The CCD provides 5.25 million total pixels of very high-resolution for crisp, clear, prints and display images.
- 2.0-inch TFT color LCD swivel monitor screen
- 40X zoom (page 66)
5X optical zoom, 8X digital zoom
- High-resolution movie recording with audio (page 104)
VGA size, 30 fps, MPEG-4 AVI format
- A choice of movie modes (page 104)
Movie modes include a standard Movie mode, a Past Movie mode (movie starts from five seconds before the shutter button was pressed), and Short Movie mode (movie is a preset length that starts before the shutter button was pressed and ends after it is pressed), and a MOVIE BEST SHOT mode (instant camera setup based on MOVIE BEST SHOT sample scenes).
- MOTION PRINT (page 141)
Capture frames from a movie and create still images that are suitable for printing.
- 7.5MB flash memory
Images can be recorded without using a memory card.

INTRODUCTION

- **Ex Finder view (page 32)**
The Ex Finder view provides you with a wealth of information on the monitor screen as you compose your images.
- **Ex Menu (page 128)**
Ex Menu gives you short-cut menu access to four frequently-used settings.
- **Multi Auto Focus (page 83)**
When “Multi” is selected for the Auto Focus area, the camera takes simultaneous meter readings at seven different points and automatically selects the best one.
- **Movable Auto Focus (AF) Area (page 82)**
You can move the focus area to the location you want.
- **Manual Assist (page 99)**
Follow the on-screen guidance when configuring manual exposure settings.
- **Support for SD memory cards and MMC (MultiMedia Cards) for memory expansion (page 166)**
- **BEST SHOT (page 100)**
Simply select the sample scene that matches the type of image you are trying to record and the camera performs troublesome setups automatically for beautiful pictures every time.
- **Triple Self-timer (page 75)**
The self-timer can be set up to repeat three times, automatically.
- **Real-time RGB histogram (page 116)**
An on-screen histogram lets you adjust exposure as you view the effect on overall image brightness, which makes shooting under difficult lighting conditions easier than ever before.
- **World Time (page 162)**
A simple operation sets the current time for your current location. You can select from among 162 cities in 32 time zones.
- **Audio Snapshot Mode (page 114)**
Use this mode to record snapshots that also include audio.
- **After Recording (page 147)**
Use this mode to add audio to snapshots after you record them.
- **Selectable Sound Settings (page 157)**
You can configure different sounds to play whenever you turn on the camera, press the shutter button half-way or all the way, or perform a key operation.
- **DCF Data Storage (page 197)**
DCF (Design rule for Camera File system) data storage protocol provides image compatibility between the digital camera and printers.

INTRODUCTION

- Digital Print Order Format (DPOF) (page 174)
Images can be printed easily in the sequence you want using a DPOF compatible printer. DPOF can also be used when specifying images and quantities for printing by professional print services.
- PRINT Image Matching III Compatible (page 182)
Images include PRINT Image Matching III data (mode setting and other camera setup information). A printer that supports PRINT Image Matching III reads this data and adjusts the printed image accordingly, so your images come out just the way you intended when you recorded them.
- PictBridge support (page 177)
Connect directly to a PictBridge compatible printer and you can print images without going through a computer.
- Transfer images to a computer simply by connecting the camera with a USB cable (pages 183, 200)
- USB 2.0 Hi-Speed protocol support (pages 184, 192)
This camera supports USB 2.0 Hi-Speed protocol. Though it can be used with a computer that supports only USB 1.1 protocol, higher speed data transfer becomes possible when USB 2.0 Hi-Speed is supported.
- Connect the camera to a TV with the AV cable and use the TV screen for image recording and viewing (page 149)
- Ulead Movie Wizard SE VCD (page 212)
Bundled Ulead Movie Wizard SE VCD software lets you edit movie files on your computer and create Video CDs. Software can be upgraded to convert files so they can be played by a DVD player.
- Bundled with Photo Loader and Photohands (pages 204, 207, 216)
Your camera comes bundled with Photo Loader, the popular application that automatically loads images from your camera to your PC. It also comes with Photohands, an application that makes image retouching quick and easy.

Precautions

General Precautions

Be sure to observe the following important precautions whenever using the EX-P505.

All references in this manual to “camera” refer to the CASIO EX-P505 Digital Camera.

- Never try to take pictures or use the built-in display while operating a motor vehicle or while walking. Doing so creates the risk of serious accident.
- Never try to open the case of the camera or attempt your own repairs. High-voltage internal components create the risk of electric shock when exposed. Always leave maintenance and repair work up to a CASIO authorized service center.
- Keep the small parts and accessories of this camera out of the reach of small children. If swallowed accidentally, contact your physician immediately.
- Never fire the flash in the direction of a person operating a motor vehicle. Doing so can interfere with the driver's vision and create the risk of accident.
- Never fire the flash while it is too close to the subject's eyes. Intense light from the flash can cause eye damage if it is fired too close to the eyes. This is especially true with young children. When using the flash, the camera should be at least one meter (3.3') from the eyes of the subject.
- Keep the camera away from water and other liquids, and never let it get wet. Moisture creates the risk of fire and electric shock. Never use the camera outdoors in the rain or snow, at the seashore or beach, in the bathroom, etc.
- Should foreign matter or water ever get into the camera, immediately turn it off. Next, remove the camera's battery and/or unplug the AC adaptor power cord from the power outlet, and contact your dealer or nearest CASIO authorized service center. Using the camera under these conditions creates the risk of fire and electric shock.
- Should you ever notice smoke or a strange odor coming out of the camera, immediately turn it off. Next, taking care you do not burn your fingers, remove the camera's battery and/or unplug the AC adaptor power cord from the power outlet, and contact your dealer or nearest CASIO authorized service center. Using the camera under these conditions creates the risk of fire and electric shock. After making sure there is no more smoke coming from the camera, take it to your nearest CASIO authorized service center for repair. Never attempt your own maintenance.

INTRODUCTION

- Never use the AC adaptor to power any other device besides this camera. Never use any other AC adaptor besides the one that comes with this camera.
 - Never cover the AC adaptor with a quilt, blanket, or other cover while it is in use, and do not use it near a heater.
 - At least once a year, unplug the AC adaptor power cord from the power outlet and clean the area around the prongs of the plug. Dust build up around the prongs can create the risk of fire.
 - If the camera's case should ever become cracked due to dropping it or otherwise subjecting it to rough treatment, immediately turn it off. Next, remove the camera's battery and/or unplug the AC adaptor power cord from the power outlet, and contact your dealer or nearest CASIO authorized service center.
 - Never use the camera inside of an aircraft or in any other area where its use is prohibited. Doing so creates the risk of accident.
 - Physical damage and malfunction of this camera can cause the data stored in its memory to be deleted. Always keep backup copies of data by transferring them to personal computer memory.
- Never open the battery cover, disconnect the AC adaptor from the camera, or unplug the AC adaptor from the wall socket while an image is being recorded. Doing so will not only make storage of the current image impossible, it can also corrupt other image data already stored in file memory.

■ Test for proper operation before using the camera!

Before using the camera to record important images, make sure you first record a number of test images and check the results to ensure that the camera is configured correctly and operating properly.

■ Data Error Precautions

- Your digital camera is manufactured using precision digital components. Any of the following creates the risk of corruption of data in file memory.
 - Removing the battery or memory card while the camera is performing a record or memory access operation
 - Removing the battery or memory card while the operation lamp is still flashing after you turn off the camera
 - Disconnecting the USB cable while a data communication operation is being performed
 - Low battery power
 - Other abnormal operations

Any of the above conditions can cause an error message to appear on the monitor screen (page 229). Follow the instructions provided by the message to eliminate the cause of the error.

■ Operating conditions

- This camera is designed for use in temperatures ranging from 0°C to 40°C (32°F to 104°F).
- Do not use or keep the camera in the following areas.
 - In areas subject to direct sunlight
 - In areas subject to high humidity or dust
 - Near air conditioners, heaters, or other areas subject to temperature extremes
 - Inside of a closed vehicle, especially one parked in the sun
 - In areas subject to strong vibration

■ Condensation

- When you bring the camera indoors on a cold day or otherwise expose it to a sudden change of temperature, there is the possibility that condensation can form on the exterior or on interior components. Condensation can cause malfunction of the camera, so you should avoid exposing it to conditions that might cause condensation.
- To keep condensation from forming, place the camera into a plastic bag before moving it into a location that is much warmer or colder than your current location. Leave it in the plastic bag until the air inside the bag has a chance to reach the same temperature as the new location. If condensation does form, remove the battery from the camera and leave the battery cover open for a few hours.

■ Power Supply

- Use only the special NP-40 rechargeable lithium ion battery to power this camera. Use of any other type of battery is not supported.
- This camera does not have a separate battery for the clock. The date and time settings of the camera are cleared whenever power is totally cut off (from both the battery and AC adaptor). Be sure to reconfigure these settings after power is interrupted (page 56).

■ Lens

- Never apply too much force when cleaning the surface of the lens. Doing so can scratch the lens surface and cause malfunction.
- Fingerprints, dust, or any other soiling of the lens can interfere with proper image recording. Never touch the lens with your fingers. You can remove dust particles from the lens surface by using a lens blower to blow them off. Next, wipe the surface of the lens with a soft lens cloth.
- You may sometimes notice some distortion in certain types of images, such as a slight bend in lines that should be straight. This is due to the characteristics of lens, and does not indicate malfunction of the camera.

■ Other

- The camera may become slightly warm during use. This does not indicate malfunction.
- If the exterior of the camera needs cleaning, wipe it with a soft, dry cloth.

QUICK START GUIDE

First, charge the battery!

1. Charge the rechargeable lithium ion battery (NP-40) that comes with the camera (page 37).

- Note that the shape of the rapid charger depends on the area where you purchased the camera.
- It takes about two hours to achieve a full charge.

1

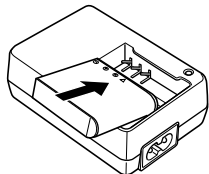

2

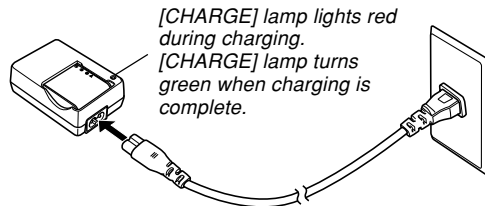

*[CHARGE] lamp lights red during charging.
[CHARGE] lamp turns green when charging is complete.*

Power Cord Type

1

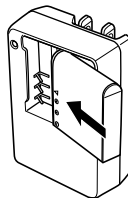

2

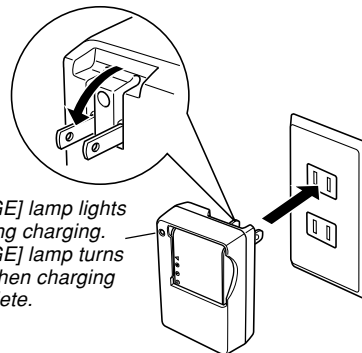

*[CHARGE] lamp lights red during charging.
[CHARGE] lamp turns green when charging is complete.*

Plug-in Type

2. Load the battery into the camera (page 42).

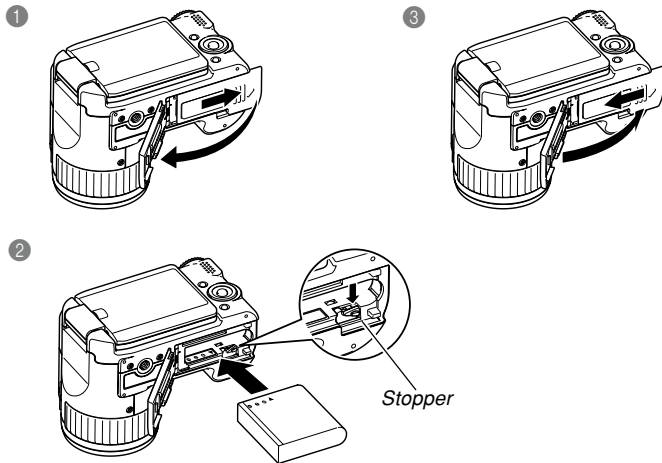

To configure display language and clock settings

- Be sure to configure the following settings before using the camera to record images. See page 56 for details.

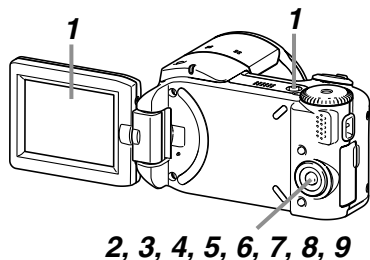

- 1. Open the monitor screen to turn on the camera.**
 - You can also turn on the camera by pressing the power button.
- 2. Press [▲] to select the language you want.**
- 3. Press [SET] to register the language setting.**
- 4. Use [▲], [▼], [◀], and [▶] to select the geographical area you want, and then press [SET].**
- 5. Use [▲] and [▼] to select the city you want, and then press [SET].**
- 6. Use [▲] and [▼] to select the summer time (DST) setting you want, and then press [SET].**
- 7. Use [▲] and [▼] to select the date format setting you want, and then press [SET].**
- 8. Set the date and the time.**
- 9. Press [SET] to register the clock settings and exit the setting screen.**

To record an image

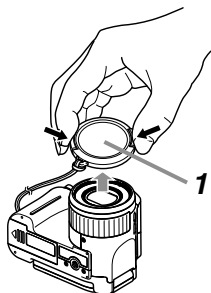

See page 59 for details.

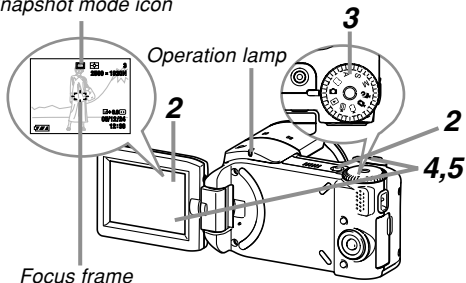

Snapshot mode icon





Before using a commercially available memory card, be sure to first format it using the camera's formatting procedure. For details about formatting a memory card, see page 169.

1. Remove the lens cap from the lens.
2. Open the monitor screen to turn on the camera.
 - You can also turn on the camera by pressing the power button.
3. Align the mode dial with “” (Snapshot mode).
 - This causes “” (Snapshot mode) to appear on the monitor screen.
4. Point the camera at the subject, use the monitor screen to compose the image, and then press the shutter button half way.
 - When the camera finishes its Auto Focus operation, the focus frame will turn green and the operation lamp will light green.
5. Holding the camera still, gently press the shutter button all the way down.

To view a recorded image

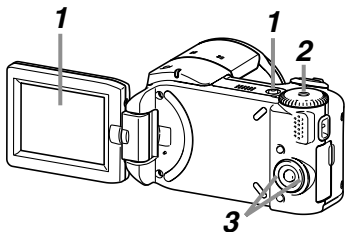
See page 130 or details.





- 1. Open the monitor screen to turn on the camera.**
 - You can also turn on the camera by pressing the power button.
- 2. Align the mode dial with “” (PLAY mode).**
- 3. Use [◀] and [▶] to scroll through the images.**

To delete an image

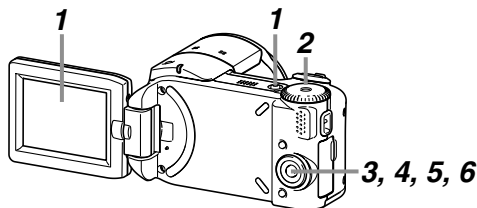
See page 152 or details.



- 1. Open the monitor screen to turn on the camera.**
 - You can also turn on the camera by pressing the power button.
- 2. Align the mode dial with “” (PLAY mode).**
- 3. Press [▼] ().**
- 4. Use [◀] and [▶] to display the image you want to delete.**
- 5. Use [▲] and [▼] to select “Delete”.**
 - To exit the image delete operation without deleting anything, select “Cancel”.
- 6. Press [SET] to delete the image.**

To turn off the camera

See page 51 or details.

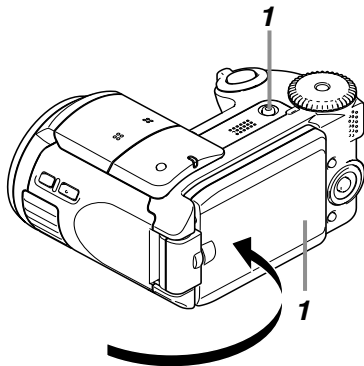

1. Position the monitor screen inwards to turn off the camera.

- You can also turn off the camera by pressing the power button.

GETTING READY

This section contains information about things you need to know about and do before trying to use the camera.

About This Manual

This section contains information about the conventions used in this manual.

■ Terminology

The following table defines the terminology used in this manual.

This term as used in this manual:	Means this:
"camera"	The CASIO EX-P505 Digital Camera
"file memory"	The location where the camera is currently storing images you record (page 62)
"battery"	The NP-40 Rechargeable Lithium Ion Battery
"rapid charger"	The CASIO BC-30L Rapid Charger

This term as used in this manual:	Means this:
"a REC mode"	The currently selected recording mode (Snapshot, BEST SHOT, Aperture Priority AE, Shutter Speed Priority AE, Manual Exposure, Movie, Short Movie, Past Movie, MOVIE BEST SHOT)
"digital noise"	Tiny flecks or "snow" in a recorded image or on the monitor screen, which makes the image look grainy.

■ Button Operations

Button operations are indicated by the button name inside of brackets ([]).

■ On-screen Text

On-screen text is always enclosed by double quotation marks (" ").

■ Supplementary Information

- **▶▶▶ IMPORTANT!** ◀◀◀ indicates very important information you need to know in order to use the camera correctly.
- **▶▶▶ NOTE** ◀◀◀ indicates information that is useful when operating the camera.

■ File Memory

The term “file memory” in this manual is a general term that refers to the location where your camera is currently storing the images you record. File memory can be any one of the following three locations.

- The camera’s built-in flash memory
- An SD memory card loaded in the camera
- A MultiMediaCard loaded in the camera

For more information about how the camera stores images, see page 197.

General Guide

The following illustrations show the names of each component, button, and switch on the camera.

■ Front

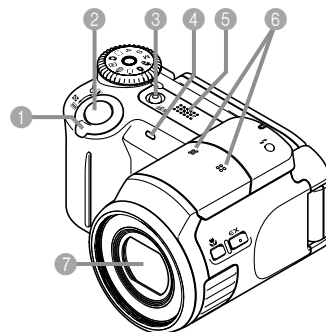

- 1 Zoom controller
- 2 Shutter button
- 3 Power button
- 4 Self-timer lamp
- 5 Speaker
- 6 Stereo microphones
- 7 Lens

■ Back

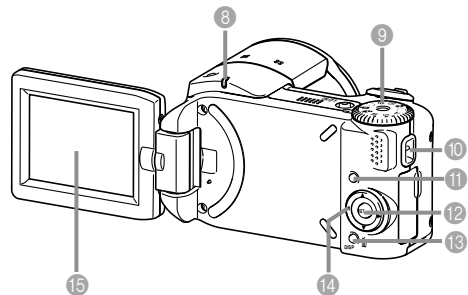

8 Operation lamp

9 Mode dial

: PLAY mode

: Snapshot mode

: BEST SHOT mode

A : Aperture Priority AE mode

S : Shutter Speed Priority AE mode

M : Manual Exposure mode

: Past Movie mode

: Short Movie mode

: MOVIE BEST SHOT mode

: Movie mode

REC modes

10 Strap ring

11 [MENU] button

12 [SET] button

13 [DISP] button

14 [▲][▼][◀][▶]

15 Monitor Screen

GETTING READY

■ Side

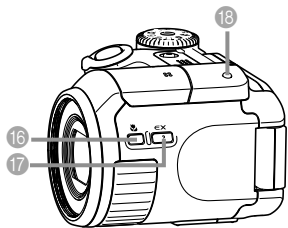

- 16 [F](Focus) button
- 17 [EX] button
- 18 [Flash] button

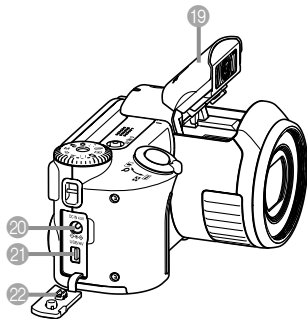

- 19 Flash
- 20 [DC IN 4.5V]
(AC adaptor
connector)
- 21 [USB/AV]
(USB/AV port)
- 22 Terminal panel cover

Open Terminal Panel Cover

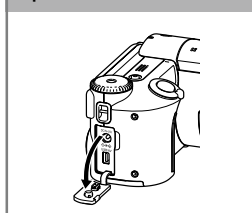

■ Bottom

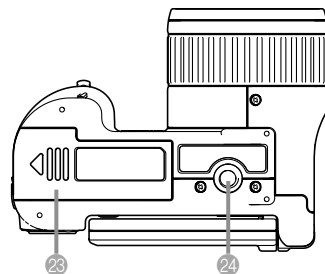

- 23 Battery cover
- 24 Tripod screw hole
 - Use this hole when attaching to a tripod.

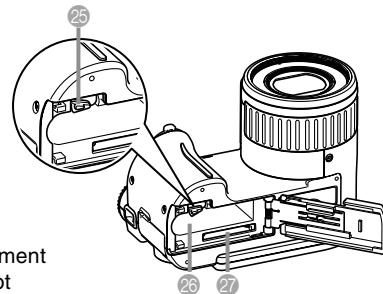

- 25 Stopper
- 26 Battery compartment
- 27 Memory card slot

Using the Monitor Screen

You can position the monitor screen to suit your shooting or viewing conditions.

Opening the monitor screen automatically turns on the camera.

▶▶ IMPORTANT! ◀◀

- When changing the position of the monitor screen, grasp the screen on its top and bottom edges. Take care you do not touch the liquid crystal panel. Also make sure you never try to force the monitor screen to move past its normal range of movement. Doing so can damage the monitor screen.

① 180 degrees left and right

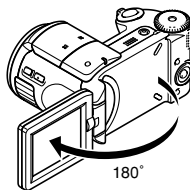

② 180 degrees forward

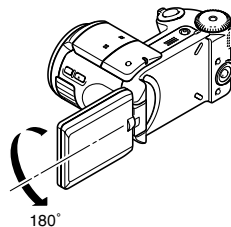

③ 90 degrees back

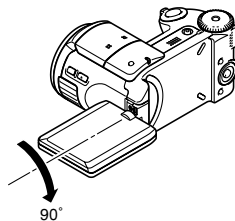

GETTING READY

- Positioning the monitor screen so it is facing the same direction as the lens causes the recorded image to be flipped into a mirror image automatically. This makes it possible to compose a self-portrait with the monitor screen.

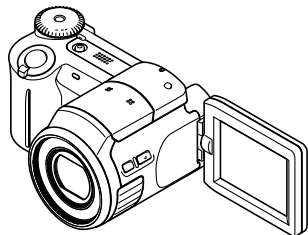

- Position the monitor screen outwards to use it for composing images.

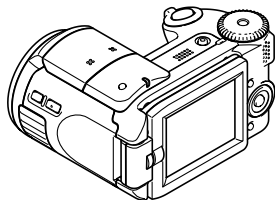

- Position the monitor screen inwards to turn off the camera.

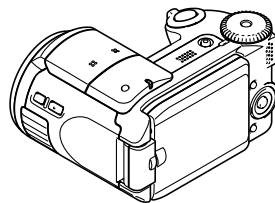

NOTE

- You can also turn the camera on and off with the power button (page 51).

IMPORTANT!

- After you are finished using the monitor screen, always close the LCD panel. Leaving the monitor screen facing open exposes the LCD panel to accidental impact, which creates the risk of breaking, cracking, etc.

Monitor Screen Contents

The monitor screen uses various indicators and icons to keep you informed of the camera's status.

- Note that the example screens in this chapter are for illustrative purposes only. They do not exactly match the screen contents actually produced on the camera.

REC Modes

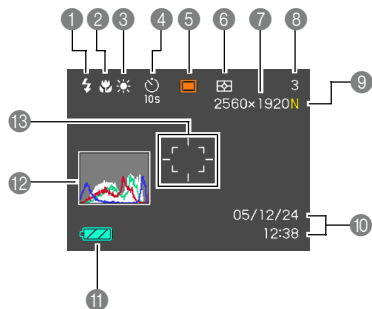

1 Flash mode indicator (page 69)

None Auto



Flash Off



Flash On



Red Eye Reduction

- If the camera detects that flash is required while auto flash is selected, the flash on indicator will appear when the shutter button is pressed half way.

2 Focus mode indicator (page 80)

None Auto Focus



Macro



Pan Focus



Infinity



Manual Focus

- PF** appears only during movie recording.

3 White balance indicator (page 91)

None Auto



Daylight



Cloudy



Shade



Fluorescent 1



Fluorescent 2



Tungsten



Flash



Manual

4 Self-timer mode (page 75)

None 1 Shot



10-second Self-timer



2-second Self-timer



Triple Self-timer

5 Recording mode (page 59)



Snapshot



BEST SHOT



Aperture Priority AE



Shutter Speed Priority AE



Manual Exposure



Movie



Past Movie



Short Movie



MOVIE BEST SHOT

6 Metering mode indicator (page 120)



Multi



Center Weighted



Spot

GETTING READY

- 7 • Snapshots: Image size (page 77)
 - 2560 × 1920 pixels
 - 2560 × 1712 (3:2) pixels
 - 2048 × 1536 pixels
 - 1600 × 1200 pixels
 - 1280 × 960 pixels
 - 640 × 480 pixels
- Movies: Recording time (page 106)

- 8 • Snapshots: Memory Capacity (pages 63, 231)
(Remaining number of storable images)
- Movies: Remaining recording time (page 106)

- 9 Image quality
 - Snapshots (page 79)
 - F : Fine
 - N : Normal
 - E : Economy
 - Movies (page 105)
 - HQ : High Quality
 - NORMAL : Normal
 - LP : Long Play

- 10 Date and time (page 159)
- 11 Battery capacity (page 45)
- 12 Histogram (page 116)
- 13 Focus frame (page 81)
 - Focused: Green
 - Unfocused: Red

NOTE

- Changing the setting of any one of the following functions will cause Icon Help text to appear on the monitor screen. You can turn off Icon Help if you want (page 124).
Recording mode, flash mode, focus mode, white balance, self-timer, metering mode

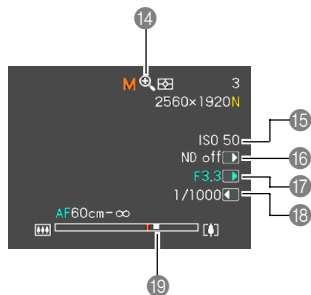

- 14 Digital zoom indicator (page 67)
- 15 ISO sensitivity (page 119)
- 16 ND filter (page 90)
- 17 Aperture value (pages 63, 94)
- 18 Shutter speed value (pages 63, 96)
- 19 Zoom indicator (page 67)
 - Left side indicates optical zoom.
 - Right side indicates digital zoom.

NOTE

- An out of range ISO sensitivity, aperture, or shutter speed setting causes the corresponding monitor screen value to turn amber.

Exposure Panel

The exposure panel is an area in the lower right corner of the REC modes monitor screen that shows various adjustable parameters. You can also use the exposure panel to adjust exposure settings.

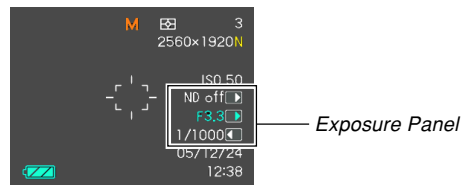

- The following explains the items that appear on the exposure panel. Note that the current REC mode determines which items appear.

- 1 ND filter (page 90)
 - Turns the ND filter on and off.
 - The exposure panel appears on the monitor screen when "A" (Aperture Priority AE) or "M" (Manual Exposure) is selected with the mode dial.



GETTING READY

2 Aperture value (pages 63, 94)

Use this item to adjust the aperture.

- The aperture value is displayed in the exposure panel when the mode dial is set to “A” (aperture priority AE) or “M” (manual exposure).

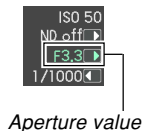

Aperture value

3 Shutter speed (pages 63, 96)

Use this item to adjust the shutter speed.

- The shutter speed is displayed in the exposure panel when the mode dial is set to “S” (shutter speed priority AE) or “M” (manual exposure).

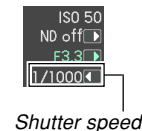

Shutter speed

4 EV shift (exposure compensation value) (page 88)

Use this item to adjust the exposure compensation (EV shift) value.

- The EV shift value appears in the exposure panel when the mode dial is set to “A” (aperture priority AE) or “S” (shutter speed priority AE). The EV shift value also appears when the mode dial is set to any setting other than “M” (manual exposure) when “EV Shift” is assigned as the “L/R Key” function (page 125).



EV shift

5 Manual Focus (MF) setting (page 86)

Use this item for adjust focus manually.

- The manual focus setting item is displayed in the exposure panel when manual focus is selected (indicated by “MF” on the monitor screen) using [M/].

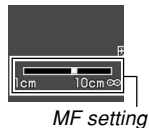

MF setting

■ Ex Finder View

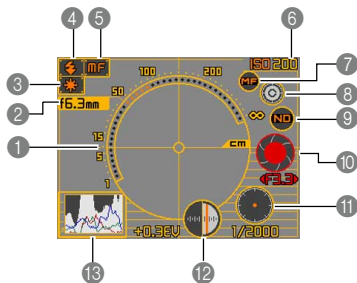

1 Focus distance scale

- This scale indicates the focus distance range. Note that this scale is not intended for precision measurement. It is provided as a general guide only.
- This scale appears when you press the shutter button half way.

2 Focal distance

3 White balance indicator (page 91)

4 Flash mode indicator (page 69)

5 Focus mode indicator (page 80)

6 ISO sensitivity (page 119)

7 Manual focus icon

- This icon is displayed only when “MF (Manual Focus)” is selected as the focus mode.
- If you use [▲] and [▼] to move the cursor to “MF” and then press [◀] or [▶], the Ex Finder view will disappear and the manual focus position indicator (page 86) will appear. After a few moments, the Ex Finder view will reappear.

8 Color change icon

- Use [▲] and [▼] to move the cursor to “C” and then press [◀] or [▶] to change the color of the Ex Finder view.

9 ND filter (page 90)

10 Aperture value (pages 63, 94)

11 Shutter speed (pages 63, 96)

- ISO sensitivity, aperture, and shutter speed values on the monitor screen will turn amber when you press the shutter button half way if the image is over-exposed or under-exposed.

12 EV shift (exposure compensation value) (page 88)

13 Histogram (page 116)

PLAY Mode

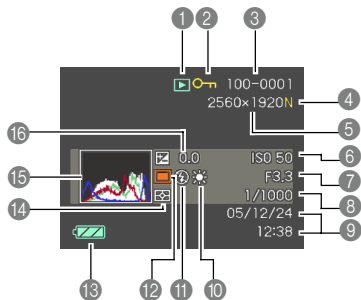

1 PLAY mode file type

- Snapshot
- Movie
- Past Movie
- Short Movie
- MOVIE BEST SHOT
- Audio Snapshot

2 Image protection indicator (page 155)

3 Folder name/File name (page 154)

Example : When a file named CIMG0023.JPG is stored in a folder named 100CASIO

100-0023
 Folder name File name

4 Snapshots: Image quality (page 79)

F : Fine
 N : Normal
 E : Economy

5 Snapshots: Image Size (page 77)

2560 × 1920 pixels
 2560 × 1712 (3:2) pixels
 2048 × 1536 pixels
 1600 × 1200 pixels
 1280 × 960 pixels
 640 × 480 pixels

6 Movies: Image quality (page 105)

HQ : High Quality
 NORMAL : Normal
 LP : Long Play

6 ISO sensitivity (page 119)

7 Aperture value (pages 63, 94)

8 Shutter speed value (pages 63, 96)

9 Date and time (page 159)





10 White balance indicator (page 91)

- Auto
- Daylight
- Cloudy
- Shade
- Fluorescent 1
- Fluorescent 2
- Tungsten
- Flash
- Manual

11 Flash mode indicator (page 69)

- Flash On
- Flash Off
- Red-eye reduction

GETTING READY

- 12 Recording mode (page 59)
 -  Snapshot
 -  BEST SHOT
 -  Aperture Priority AE
 -  Shutter Speed Priority AE
 -  Manual Exposure
- 13 Battery capacity (page 45)
- 14 Metering mode indicator (page 120)
- 15 Histogram (page 116)
- 16 EV value (page 88)

Changing the Contents of the Monitor Screen

Each press of the [DISP] button changes the contents of the monitor screen as shown below.

■ REC Modes

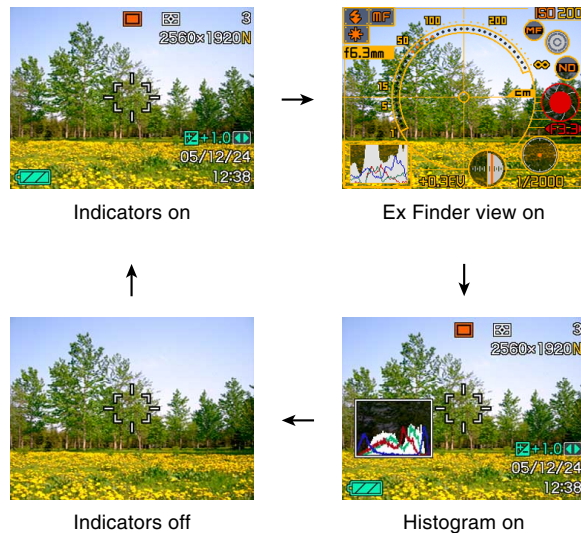

■ PLAY Mode



Indicators on



Histogram/Details on



Indicators off



▶▶ IMPORTANT! ◀◀

- The Ex Finder view cannot be displayed in the following modes: PLAY, Movie, Past Movie, Short Movie, MOVIE BEST SHOT.
- Pressing [DISP] will not change monitor screen contents during movie recording, or during standby or recording of an audio snapshot.

Attaching the Strap

Attach the strap to the strap ring as shown in the illustration.

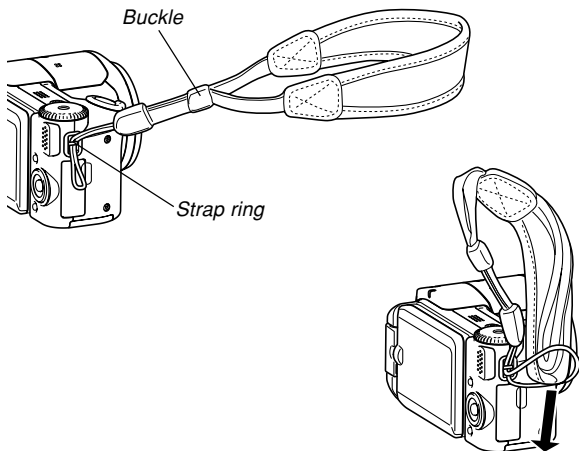

►► IMPORTANT! ◀◀

- To avoid dropping the camera while operating it, be sure to wear the strap around your wrist. Use the buckle to ensure that the strap is fastened snugly around your wrist.
- The supplied strap is intended for use with this camera only. Do not use it for any other purpose.
- Never swing the camera around by the strap.

GETTING READY

Using the Lens Cap

Always keep the lens cap on the lens whenever you are not using the camera.

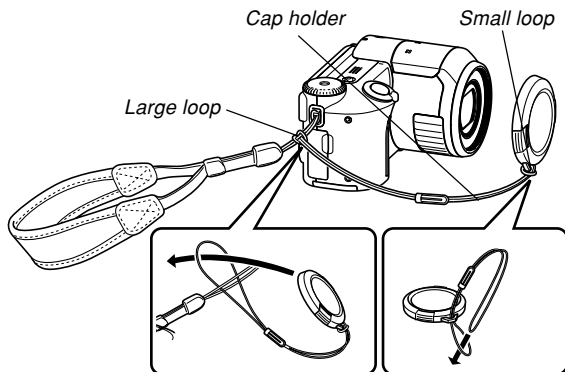

Attach the lens cap holder to the strap. This protects against accidental loss of the lens cap.

Power Requirements

Your camera can operate on either battery power or AC power.

- Battery
One NP-40 rechargeable lithium ion battery

The battery is not fully charged when you use the camera for the first time after purchasing it. You need to charge the battery before using the camera for the first time.

- Household AC Power
AC Adaptor: AD-C40 (Option)

Using the Rapid Charger

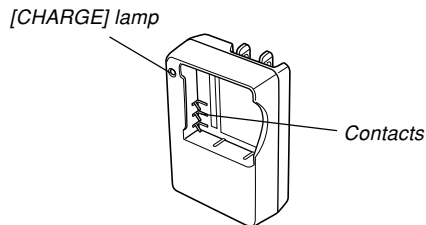

GETTING READY

■ Loading the Battery into the Rapid Charger

Making sure that the positive and negative contacts are aligned correctly, load the battery into the rapid charger. Note that the battery will not charge properly if it is not positioned correctly in the rapid charger.

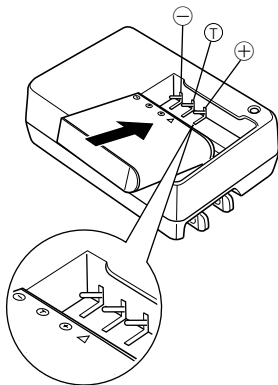

■ To charge the battery

1. **Correctly positioning the positive and negative terminals of the battery, load the battery into the rapid charger.**

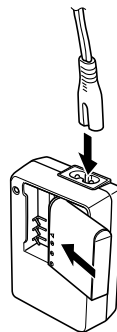

Power Cord Type

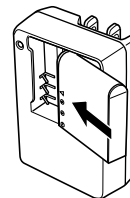

Plug-in Type

2. Plug the rapid charger into a household power outlet.

- This will cause the [CHARGE] lamp to turn red.
- Charging will take about two hours.
- Note that the shape of the rapid charger depends on the area where you purchased the camera.

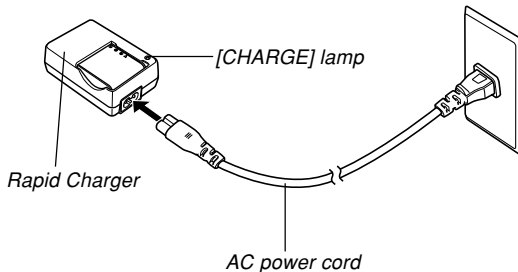

NOTE

- The power cord type rapid charger is designed for operation with any power supply in the range of 100V to 240V AC. Note, however, that the shape of the AC power cord plug varies according to country or geographic area. If you plan to use the rapid charger in a geographic area where the power receptacle shape is different from that in your area, replace the AC power cord with one of the other ones that come with the camera, or purchase a commercially available AC power cord that is compatible with the power outlets in that area.

GETTING READY

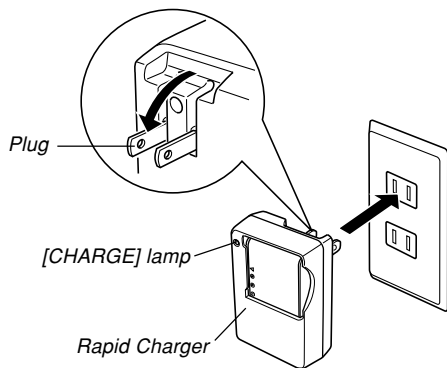

NOTE

- The plug-in type rapid charger is designed for operation on power ranging from 100V AC to 240V AC. Note, however, that the shape of the power plug varies according to country or geographic area. When traveling abroad, it is up to you to find out if the shape of the rapid charger power plug is compatible with local power outlets and to purchase any required adaptors.

3. The [CHARGE] lamp turns green when charging is complete.

4. After charging is complete, unplug the rapid charger from the power outlet, and remove the battery from it.

- Always unplug the rapid charger from the power outlet and remove the battery whenever you are not charging.

▶▶ IMPORTANT! ◀◀

- If the battery or rapid charger is very hot or cold when you start charging or if it becomes hot during charging, the rapid charger will enter a standby state, which is indicated when its [CHARGE] lamp is lit amber. Charging will resume when the temperature returns to the allowable charging temperature range, which is indicated when the [CHARGE] lamp turns red.
 - Charging the battery while it is still warm immediately after removing it from the camera can result in only partial charging. Give the battery time to cool before charging it.
 - Battery discharges slightly even when it is left without loading it into the camera. Because of this, it is recommended that you charge the battery immediately before you need to use it.
 - The battery used with this camera is specifically designed for use with digital cameras. If you want to try to use it to power another type of device, you should first check the user documentation that comes with the device to see if the battery is compatible.
 - Though the actual service life of the battery depends on the environment under which it is used, you can expect to be able to recharge it about 500 times before it needs replacement.
- Charging the battery may cause interference with TV and radio reception. If this happens, plug the charger into an outlet that is further away from the TV or radio.
 - Dirty charger contacts and/or battery terminals can make proper charging impossible. Be sure to wipe contacts and terminals occasionally with a dry cloth to keep them clean.

To load the battery

1. Slide the battery cover on the bottom of the camera in the direction indicated by the arrow, and then swing it open.

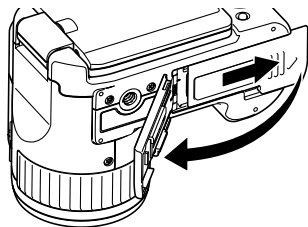

2. Aligning the (▲) marks on the camera and battery as shown in the illustration, press down on the stopper in the direction indicated by the arrow and slide the battery into the camera.

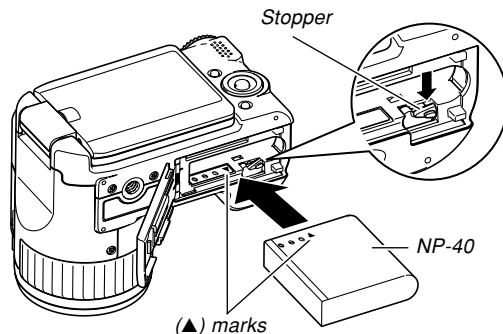

- Push the bottom of the battery, and make sure that the stopper securely locks the battery in place.

3. Swing the battery cover closed, and then slide it in the direction indicated by the arrow.

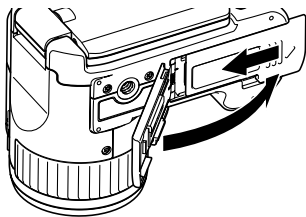

▶▶ IMPORTANT! ◀◀

- Use only the special NP-40 rechargeable lithium ion battery to power this camera. Use of any other type of battery is not supported.

■ If the camera does not work normally

This can mean there is a problem with how the battery is loaded. Remove the battery from the camera and check the battery contacts for dirt. If the contacts are dirty, wipe them clean with a dry cloth.

■ Battery Life Guidelines

The battery life guideline values given below indicate the amount of time under the conditions defined below the table, until power automatically turns off due to battery failure. They do not guarantee that the battery will provide the amount of service indicated. Low temperatures and continued use reduce battery life.

Operation	Apporoximate Battery Life
Number of Shots (CIPA Standard)* ¹ (Operating Time)	220 shots (110 minutes)
Number of Shots, Continuous Recording* ² (Operating Time)	550 shots (110 minutes)
Continuous Snapshot Playback* ³	200 minutes
Continuous Movie Recording* ⁴	120 minutes

Supported Battery: NP-40
Storage Medium: SD Memory Card

- *1 Number of Shots (CIPA Standard)
 - Temperature: 23°C (73°F)
 - Monitor Screen: On
 - Zoom operation between full wide to full telephoto every 30 seconds, during which two images are recorded, one image with flash; power turned off and back on every time 10 images are recorded.
- *2 Continuous Recording Conditions
 - Temperature: 23°C (73°F)
 - Monitor screen: On
 - Flash: Off
 - Image recorded every 12 seconds, alternating full wide-angle and full telephoto zoom
- *3 Continuous Snapshot Playback Conditions
 - Temperature: 23°C (73°F)
 - Scroll one image about every 10 seconds
- *4 Approximate time for continuous movie recording, without using zoom.



GETTING READY





- The above values are based on a new battery starting from a full charge. Repeated charging shortens battery life.
- Battery life is greatly affected by how much you use flash, zoom and auto focus, and how long you leave power turned on.

■ Tips to Make the Battery Last Longer

- If you do not need the flash while recording, select  (flash off) for the flash mode. See page 69 for more information.
- Enable the Auto Power Off and the Sleep features (page 52) to protect against wasting battery power when you forget to turn off the camera.
- Using Manual Focus (page 86) or Pan Focus (page 85) during movie recording extends battery life.

■ Low Battery Indicator

The following shows how the battery capacity indicator on the monitor screen changes as battery power is used. The  indicator means that remaining battery power is low. Note that you will not be able to record images while the battery indicator is . Charge the battery immediately whenever either of these indicators appears.

Battery Level	High ←————→ Low
Indicator	 →  →  → 

To replace the battery

1. Open the battery cover.
2. Press down on the stopper in the direction indicated by the arrow.
 - This will cause the battery to come part way out of the slot.

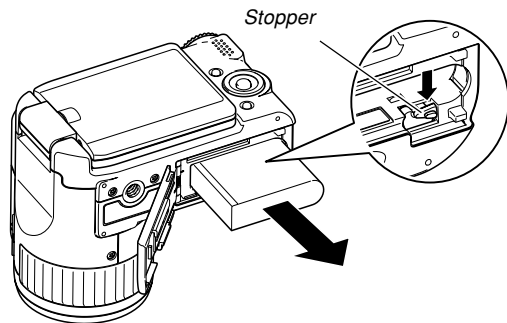

3. Release the stopper and pull the battery from the camera.
 - Take care so you do not drop the battery.
4. Load a new battery into the camera (page 42).

Power Supply Precautions

Note the following precautions when handling or using the battery and the rapid charger.

■ Battery Handling Precautions

● SAFETY PRECAUTIONS

Be sure to read the following Safety Precautions before using the battery for the first time.

▶▶ NOTE ◀◀

- The term “battery” in this manual refers to the CASIO NP-40 Rechargeable Lithium Ion Battery.
- Use only the rapid charger (BC-30L) to charge the special NP-40 rechargeable lithium ion battery. Never use any other charging device.

GETTING READY

- Failure to observe any of the following precautions while using the battery creates the risk of overheating, fire, and explosion.
 - Never try to use the battery to power any device other than this camera.
 - Never use or leave the battery near open flame.
 - Never place the battery in a microwave oven, throw it into fire, or otherwise expose it to intense heat.
 - Make sure the battery is oriented correctly when you load it into the camera or attach it to the rapid charger.
 - Never carry or store the battery together with items that can conduct electricity (necklaces, pencil lead, etc.)
 - Never try to take the battery apart, modify it in any way, or expose it to strong impact.
 - Do not immerse the battery in fresh water or salt water.
 - Do not use or leave the battery under direct sunlight, in an automobile parked in the sun, or in any other area subject to high temperatures.
- Should you ever notice any of the following conditions while using, charging, or storing a battery, immediately remove it from the camera or rapid charger, and keep it away from open flame:
 - Fluid leaking
 - Emission of a strange odor
 - Heat emission
 - Battery discoloration
 - Battery deformation
 - Any other battery abnormality
- If the battery does not achieve full charge after the normal charging time has passed, stop charging. Continued charging creates the risk of overheating, fire, and explosion.
- Battery fluid can damage your eyes. Should battery fluid get into your eyes accidentally, immediately rinse them with clean tap water and then consult a physician.
- If the battery is to be used by young children, make sure that a responsible adult makes them aware of the precautions and proper handling instructions and make sure that they handle the battery correctly.
- Should fluid from the battery accidentally get onto clothing or your skin, immediately rinse it off with clean tap water. Prolonged contact with battery fluid can cause skin irritation.

● PRECAUTIONS DURING USE

- Charge the battery in a location where the temperature is in the range of 5°C to 35°C (41°F to 95°F). Charging outside this temperature range can cause charging to take longer than normal or even cause charging to fail.
- Very limited operation following a full charge indicates that the battery has reached the end of its service life. Replace the battery with a new one.
- Never wipe the battery with thinner, benzene, alcohol, or other volatile agents or chemically treated rags. Doing so can cause deformation of the battery and lead to malfunction.
- Always make sure that the rapid charger is on a level surface when using it for charging.

● BATTERY STORAGE PRECAUTIONS

- Make sure you remove the battery from the camera when you do not plan to use it for a long time. A battery left in the camera discharges very small amounts of power even when power is turned off, which can lead to a dead battery or the need for longer charging before the next use.
- Store the battery in a cool, dry place (20°C (68 °F) or lower).

● USING THE BATTERY

- When transporting a battery, keep it either loaded in the camera or stored in its case.

■ Rapid Charger Precautions

- Never plug the rapid charger into an outlet whose voltage rating is different from that marked on the rapid charger. Doing so creates the risk of fire, malfunction, and electric shock.
- Never plug in or unplug the rapid charger while your hands are wet. Doing so creates the risk of electric shock.
- Do not plug the rapid charger into an outlet or extension cord that is shared by other devices. Doing so creates the risk of fire, malfunction, and electric shock.
- The rapid charger becomes slightly warm during charging. This is normal and does not indicate malfunction.
- Unplug the rapid charger from the power outlet whenever you are not using it.
- Never use the rapid charger with a voltage converter. Doing so can damage it. The rapid charger can be used where the power supply is in the range of 100V to 240V AC.

Using AC Power

You need to purchase the optionally available AC adaptor (AD-C40) in order to be able to power the camera using AC power.

- 1. Connect the AC power cord to the AC adaptor.**
- 2. Open the camera's terminal panel cover and connect the AC adaptor to the port marked [DC IN 4.5V].**

3. Plug the AC power cord into an electrical outlet.

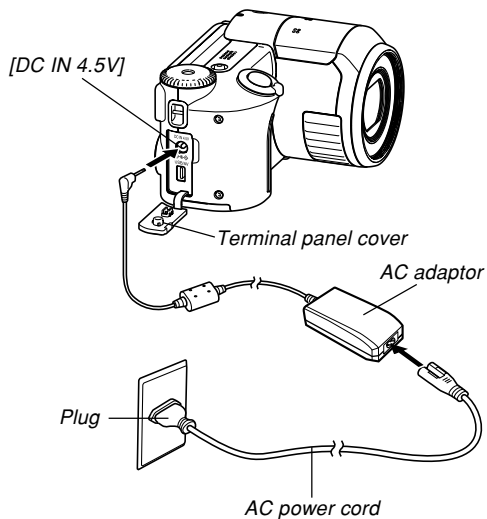

■ Using AC Adaptor In Another Geographic Area

- The AC adaptor can be used with any power source rated from 100V to 240V AC. If you plan to use the AC adaptor in another country, it is up to you to purchase the applicable AC power cord that matches the configuration of power receptacles in that country.

■ AC Adaptor Precautions

- Be sure to turn off power before connecting or disconnecting the AC adaptor.
- Always turn camera power off before disconnecting the AC adaptor, even if the camera has a battery installed. If you don't, the camera will turn off automatically when you disconnect the AC adaptor. You also run the risk of damaging the camera whenever you disconnect the AC adaptor without first turning power off.
- The AC adaptor may become warm to touch after extended periods of use. This is normal and is not cause for alarm.
- After using the camera, turn it off and unplug the AC adaptor from the AC outlet.
- The camera automatically switches over to AC adaptor powered operation whenever the AC adaptor is plugged into the camera.
- Use of the AC adaptor to power the camera is recommended when connected to a computer.
- Never place a blanket or any other cover on the AC adaptor. Doing so creates the risk of fire.

Turning the Camera On and Off

Press the power button to turn on the camera, which causes the operation lamp to light green momentarily. Press the power button again to turn off the camera. Opening the monitor screen also turns on the camera, and closing the screen turns it off.

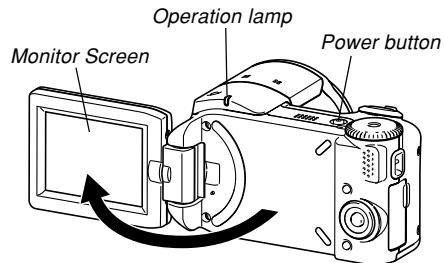

►► IMPORTANT! ◀◀

- If camera power is turned off by the Auto Power Off feature, press the power button to turn it back on again.

Configuring Power Saving Settings

You can configure the settings described below to conserve battery power.

- Sleep** : Automatically turns off the monitor screen if no operation is performed for a specified amount of time in a REC mode. Performing any button operation causes the monitor screen to turn back on.
- Auto Power Off** : Turns off power if you do not perform any operation for a specified amount of time.

1. Turn on the camera.
2. Press [MENU].
3. Use [◀] and [▶] to select the “Set Up” tab.
4. Use [▲] and [▼] to select the feature whose setting you want to configure, and then press [▶].

- See “Using the On-screen Menus” (page 53) for information about how to use menus.

To configure this feature:	Select this setting:
Sleep	Sleep
Auto Power Off	Auto Power Off

5. Use [▲] and [▼] to change the currently selected setting, and then press [SET].

- Available Sleep settings are: “30 sec”, “1 min”, “2 min”, and “Off”.
- Available Auto Power Off settings are: “2 min” and “5 min”.
- Note that the Sleep feature does not operate in the PLAY mode.
- Pressing any button while the camera is in the Sleep state immediately turns the monitor screen back on.

GETTING READY

- The Auto Power Off and Sleep features are disabled in the following cases.
 - While the camera is connected to computer or TV via its USB/AV port
 - While a slideshow is in progress
 - While a movie is being recorded
 - While playing back a movie
 - During Short Movie standby
 - During Past Movie standby

Using the On-screen Menus

Pressing [MENU] displays menus on the monitor screen that you can use to perform various operations. The menu that appears depends on whether you are in a REC mode or the PLAY mode. The following shows an example menu procedure in the Snapshot mode.

1. Turn on the camera, and then align the mode dial with “”.

- If you want to enter the PLAY mode instead, you would align the mode dial with “”.

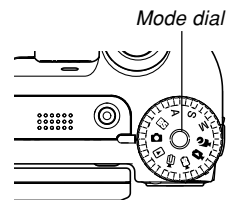

2. Press [MENU].

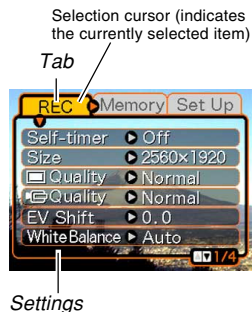
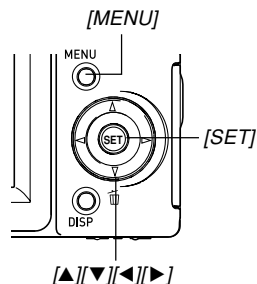

● Menu Screen Operations

When you want to do this:	Do this:
Move between tabs	Press [◀] and [▶].
Move from the tab to the settings	Press [▼].
Move from the settings to the tab	Press [▲].
Move between the settings	Press [▲] and [▼].
Display the options available for a setting	Press [▶] or press [SET].
Select an option	Press [▲] and [▼].
Apply the setting and exit the menu screen	Press [SET].
Apply the setting and return to tab selection	Press [◀].
Exit the menu screen	Press [MENU].

3. Press [◀] or [▶] to select the tab you want, and then press [SET] to move the selection cursor from the tab to the settings.

4. Use [▲] and [▼] to select the feature whose setting you want to configure, and then press [▶].

- Instead of pressing [▶], you could also press [SET].



Example: To select the "Self-timer" item.

5. Use [▲] and [▼] to change the currently selected setting.

6. Perform one of the following operations to apply the setting you configured.

To do this:	Perform this key operation:
Apply the setting and exit the menu screen.	Press [SET].
Apply the setting and return to feature selection in step 4.	Press [◀].
Apply the setting and return to tab selection in step 3.	1. Press [◀]. 2. Use [▲] to move back up to tab selection.

- See "Menu Reference" on page 219 for more information about menus.

Configuring Display Language and Clock Settings

Be sure to configure the following settings before using the camera to record images.

- Display language
- Home city
- Date Style
- Date and time

Note that the current date and time settings are used by the camera to generate the date and time that are stored along with image data, etc.

►► IMPORTANT! ◀◀

- Recording images without configuring the clock settings causes incorrect time information to be registered. Be sure to configure the clock settings before using the camera.

- A built-in backup battery retains the date and time settings of the camera for about two days if the camera is not supplied with power. Date and time settings will be cleared when the backup battery goes dead. The following are the conditions when power is not being supplied to the camera.
 - When the rechargeable battery is dead or removed from the camera
 - When using the AC adaptor to power the camera, disconnecting the AC adaptor
- The date and time setting screen will appear on the monitor screen the next time you turn on the camera after the date and time settings have been cleared. If this happens, reconfigure the date and time settings.
- If you make a mistake when setting the language or clock with the following procedure, you will need to use the camera's menu to individually change the language (page 163) or clock (page 159) settings.
- You will not be able to edit time data stored with images that are recorded while the camera's time setting is wrong.
- Even if you configure date and time settings, the date and time are not stamped into the images themselves. Note, however, that you can specify inclusion of the date inside of an image when printing (page 181).

To configure display language and clock settings

1. Open the monitor screen to turn on the camera.

- You can also turn on the camera by pressing the power button.

2. Use [▲], [▼], [◀], and [▶] to select the language you want, and then press [SET].



日本語	: Japanese
English	: English
Français	: French
Deutsch	: German
Español	: Spanish
Italiano	: Italian
Português	: Portuguese
中國語	: Chinese (Complex)
中国語	: Chinese (Simplified)
한국어	: Korean

3. Use [▲], [▼], [◀], and [▶] to select the geographical area where you live, and then press [SET].



4. Use [▲] and [▼] to select the name of the city where you live, and then press [SET].



5. Use [▲] and [▼] to select the summer time (DST) setting you want, and then press [SET].

When you want to do this:	Select this setting:
Keep time using summer time (Daylight Saving Time)	On
Keep time using standard time	Off

GETTING READY

6. Use [▲] and [▼] to select the date format setting you want, and then press [SET].

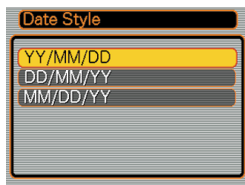

Example: December 24, 2005

To display the date like this:	Select this format:
05/12/24	YY/MM/DD
24/12/05	DD/MM/YY
12/24/05	MM/DD/YY

7. Set the current date and the time.

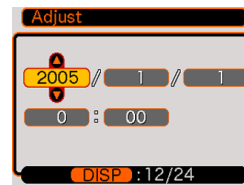

To do this:	Do this:
Change the setting at the current cursor location	Press [▲] and [▼].
Move the cursor between settings	Press [◀] and [▶].
Toggle between 12-hour and 24-hour timekeeping	Press [DISP].

8. Press [SET] to register the settings and exit the setting screen.

BASIC IMAGE RECORDING

This section describes the basic procedure for recording an image.







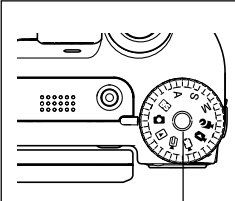



Recording an Image



Specifying the Recording Mode

Your CASIO digital camera has nine recording modes, each of which is described below. Before recording an image, use the mode dial to select the recording mode that suits the type of image you are trying to record.





Mode dial

	Snapshot mode
	BEST SHOT mode
	Aperture Priority AE mode
	Shutter Speed Priority AE mode
	Manual Exposure mode
	Past Movie mode
	Short Movie mode
	MOVIE BEST SHOT mode
	Movie mode
	PLAY mode

-  (Snapshot mode)
Use this mode to record still images. This is the mode you should normally use for image recording.
-  (BEST SHOT mode)
This mode makes camera setup as easy as selecting the applicable sample scene. Simply select one of 22 sample scenes, and the camera will automatically be configured with the settings required to record a similar image (page 100).
- **A** (Aperture Priority AE mode)
In this mode, you select the aperture, and other settings are adjusted accordingly (page 94).
- **S** (Shutter Speed Priority AE mode)
In this mode, you select the shutter speed, and other settings are adjusted accordingly (page 96).
- **M** (Manual Exposure mode)
This mode gives you total control over aperture and shutter speed settings (page 97).
-  (Past Movie mode)
Pressing the shutter button starts recording from five seconds prior to the point the button is pressed. Use this mode when you want to make sure you do not miss fast-moving action (page 107).

BASIC IMAGE RECORDING

-  (Short Movie mode)
Each press of the shutter button in this mode records a short movie that starts before the button is pressed and ends after the button is pressed (page 108).
-  (MOVIE BEST SHOT mode)
This mode makes camera setup as easy as selecting the applicable sample scene. Select one of the MOVIE BEST SHOT scenes and the camera automatically configures itself with the setup for that scene (page 111).
-  (Movie mode)
Use this mode for general movie recording (page 106).

NOTE

- The icon of the currently selected recording mode (like  for the Snapshot mode) is displayed on the monitor screen.

Snapshot mode icon

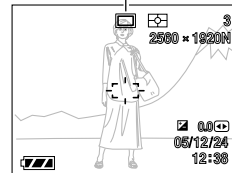

Aiming the Camera

Use both hands to hold the camera still when shooting an image. Holding the camera with one hand increases the chance of movement, which can blur your images.

- Horizontal

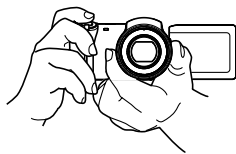

Hold the camera still in both hands, with your arms firmly against your sides.

- Vertical

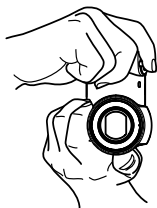

IMPORTANT!

- Make sure your fingers and the strap do not block the flash, stereo microphones or lens.

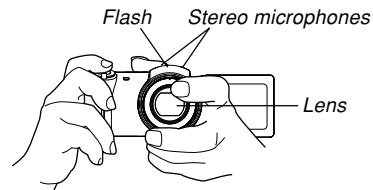

NOTE

- Moving the camera as you press the shutter button or while the Auto Focus operation is being performed (when you press the shutter button half way) can cause blurring of the image. Press the shutter button carefully, taking care to avoid camera movement. This is especially important when available lighting is low, which slows down the shutter speed.

Recording an Image

Your camera automatically adjusts shutter speed in accordance with the brightness of the subject. Images you record are stored in the camera's built-in memory, or to a memory card if you have one loaded in the camera.

- When an optionally available SD memory card or MultiMediaCard (MMC) is loaded in the camera, images are stored on the card (page 166).

After purchasing a memory card, be sure to load it into the camera and format it before trying to use it (page 169).

1. Remove the lens cap from the lens.

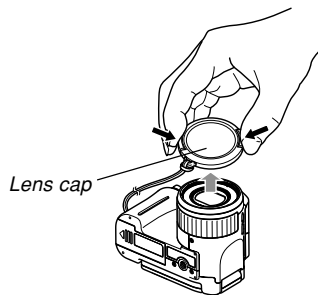

2. Open the monitor screen or press the power button to turn on the camera.

- This causes an image or a message to appear on the monitor screen.

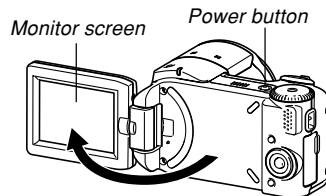

3. Align the mode dial with "Ⓜ" (Snapshot mode).

- This enters the Snapshot mode for image recording.

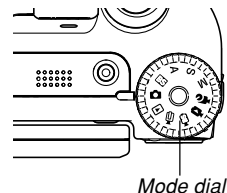

4. Compose the image on the monitor screen so the main subject is within the focus frame.

- The focusing range of the camera depends on focus mode you are using (page 80).

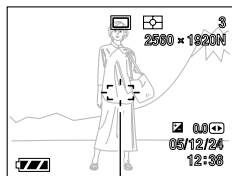

Focus frame

5. Press the shutter button half way to focus the image.

- When you press the shutter button half way, the camera's Auto Focus feature automatically focuses the image, and displays the shutter speed and aperture values.
- You can tell whether the image is focused by observing the focus frame and the operation lamp.

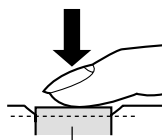

Shutter button

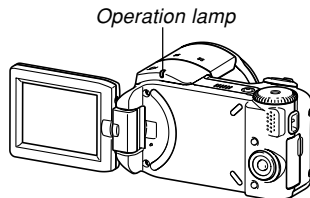

● Operation Lamp and Focus Frame Operation

When you see this:	It means this:
Green focus frame Green operation lamp	The image is in focus.
Red focus frame Flashing green operation lamp	The image is not in focus.

- The monitor screen uses various indicators and icons to keep you informed of the camera's status.

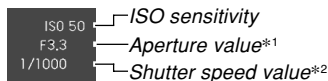
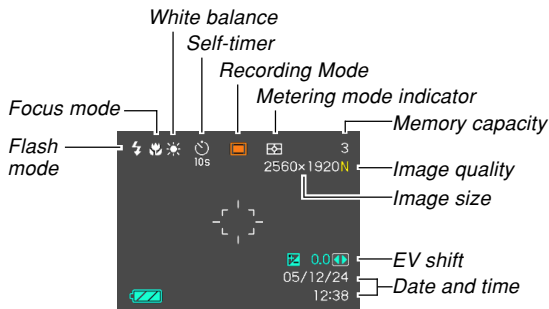

BASIC IMAGE RECORDING

- *1 The size of the opening (aperture) that allows light passing through the lens to reach the CCD. A larger aperture value indicates a smaller opening for light to pass through.
- *2 The amount of time the shutter remains open, allowing light passing through the lens to reach the CCD. A larger shutter speed value indicates that the shutter remains open longer, which means more light reaches the CCD.

6. After making sure that the image is focused properly, press the shutter button the rest of the way down to record.

- The number of images you can record depends on the image size and the image quality setting you are using (pages 77, 79, 231).

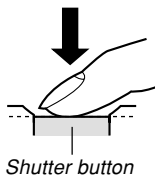

■ Recording Precautions

- Never open the battery cover or unplug the AC adaptor while the operation lamp is flashing green. Doing so not only causes the current image to be lost, it can also corrupt images already stored in file memory and even lead to malfunction of the camera.
- Never remove the memory card while an image is being recorded to the memory card.
- Fluorescent lighting actually flickers at a frequency that cannot be detected by the human eye. When using the camera indoors under such lighting, you may experience some brightness or color problems with recorded images.
- When "Auto" is selected for the ISO sensitivity setting (page 119), the camera automatically adjusts its sensitivity in accordance with the brightness of the subject. This can cause some digital noise (graininess) to appear in images of relatively dark subjects.
- When recording a dimly lit subject while "Auto" is selected for the ISO sensitivity setting (page 119), the camera increases sensitivity and uses a faster shutter speed. Because of this, you need to guard against camera movement if you have flash turned off  (page 69).
- Bright light shining on the lens can cause images to appear "washed out". This tends to happen when recording images outdoors in bright sunlight. To protect against this, use your free hand to shade the lens from the light.

■ About Auto Focus

- Proper focus may be difficult or even impossible when shooting the following types of subjects.
 - Solid color walls or subjects with little contrast
 - Strongly backlit subjects
 - Very shiny objects
 - Venetian blinds or other horizontally repeating patterns
 - Multiple subjects that are varying distances from the camera
 - Subjects in poorly lit areas
 - Moving subjects
 - Subjects outside the shooting range of the camera
- Note that a green operation lamp and focus frame do not necessarily guarantee that the resulting image will be in focus.
- If Auto Focus does not produce the results you want for some reason, try using focus lock (page 87) or manual focus (page 86).

■ About the REC Mode Monitor Screen

- The image shown on the monitor screen in a REC mode is a simplified image for composing purposes. The actual image is recorded in accordance with the image quality setting currently selected on your camera. The image saved in file memory has much better resolution and detail than the REC mode monitor screen image.
- Certain levels of subject brightness can cause the response of the REC mode monitor screen to slow down, which causes some digital noise (graininess) in the monitor screen image.
- Very bright light inside of an image can cause a vertical band to appear in the monitor screen image. This is a CCD phenomenon known as “vertical smear”, and does not indicate malfunction of the camera. Note that vertical smear is not recorded with the image in the case of a snapshot, but it is recorded in the case of a movie (page 104).

Using Zoom

Your camera is equipped with two types of zoom: optical zoom and digital zoom. Normally, the camera automatically switches over to digital zoom after you reach the maximum limit for optical zoom. You can, however, configure the camera to disable digital zoom, if you want.

Optical Zoom

The optical zoom range is 1X to 5X.

- The optical zoom range when Macro is selected as the focus mode (page 84) is 1X to 2.25X.

1. In a REC mode, move the zoom controller left or right to zoom.

- Moving the zoom controller as far as it goes in either direction will zoom at high speed.

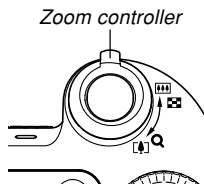

To do this:	Move the zoom controller in this direction:
Zoom out	(Wide Angle)
Zoom in	(Telephoto)

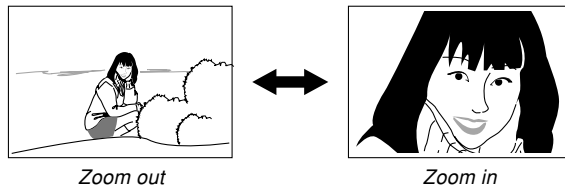

2. Compose the image, and then press the shutter button.

NOTE

- The optical zoom factor also affects the lens aperture.
- Use of a tripod is recommended to protect against hand movement when using the telephoto setting (zoom in).
- Whenever you perform an optical zoom operation, a value will appear on the monitor screen to tell you the focusing range (pages 82, 84, 87).

Digital Zoom

Digital zoom digitally enlarges the part of the image at the center of the image screen. The range of digital zoom is 5X to 40X (in combination with optical zoom).

▶▶ IMPORTANT! ◀◀

- When you perform a digital zoom operation, the camera manipulates the image data to enlarge the center of the image. Unlike optical zoom, an image enlarged with digital zoom appears coarser than the original.

■ To record an image using digital zoom

1. In a REC mode, hold the zoom controller towards [A] (telephoto) / Q side.

- This causes the zoom indicator to appear on the display.

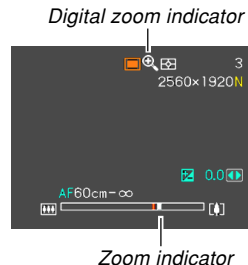

2. When the zoom pointer reaches the optical/digital zoom switch over point, it will stop.

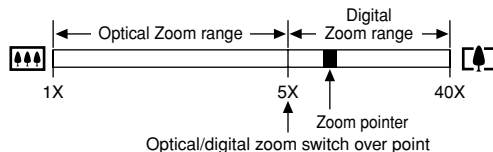

- The above shows what the zoom indicator looks like when digital zoom is turned on (page 68). The digital zoom range is not displayed when digital zoom is turned off.

3. Release the zoom controller momentarily, and then slide it towards [📷] (telephoto) / 🔍 side again to move the zoom pointer into the digital zoom range.

- The zoom pointer will also stop when you move the pointer back to the switch over point to re-enter the optical zoom range. Release the zoom controller and then slide it towards [📷] (wide angle) / 📷 side again to move into the optical zoom range.

4. Compose the image, and then press the shutter button.

■ **To turn digital zoom on and off**

1. In a REC mode, press [MENU].
2. Use [◀] and [▶] to select the “REC” tab.
3. Use [▲] and [▼] to select “Digital Zoom”, and then press [▶].
4. Use [▲] and [▼] to select the setting you want, and then press [SET].

To do this:	Select this setting:
Turn on digital zoom	On
Turn off digital zoom	Off

- Only the optical zoom range is displayed in the zoom level indicator when digital zoom is turned off.

Using the Flash

Perform the following steps to select the flash mode you want to use.

- The approximate effective range of the flash is shown below.

Approximately 0.4 to 3.0 meters (1.3' to 9.8')
(ISO Sensitivity: Auto)

* Depends on zoom factor.

1. In a REC mode, press [F].

- Each press of [F] cycles through the flash mode settings described below on the monitor screen.

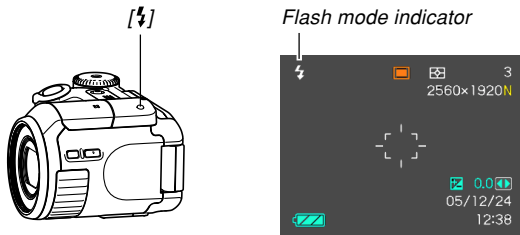

To do this:	Select this setting:
Have the flash fire automatically when required (Auto Flash)*	None
Turn off the flash (Flash Off)	
Always fire the flash (Flash On)	
Fire a pre-flash followed by image recording with flash, reducing the chance of red-eye in the image (Red-eye reduction) In this case, the flash fires automatically when required	

* When using Icon Help (page 124), select “ Auto Flash”.

2. Record the image.

- If the camera senses that the flash is necessary, the flash unit will pop up automatically if you press the shutter release half way or all the way down.
- Note that the flash unit does not close automatically. After you are finished using it, you need to close it by hand.

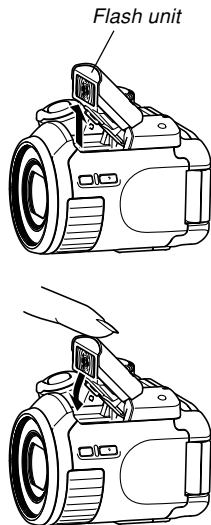

▶▶ IMPORTANT! ◀◀

- The flash unit of this camera fires a number of times when you record an image. The initial flashes are pre-flashes, which the camera uses to obtain information that it uses for exposure settings. The final flash is for recording. Make sure that you keep the camera still until the shutter releases.
- Using the flash while “Auto” is selected for the ISO Sensitivity setting increases sensitivity, which can cause large amounts of digital noise to appear in the image. You can reduce digital noise by using a lower ISO Sensitivity setting. Note, however, that this also has the effect of shortening the flash range (the range that is covered by the light from the flash) (page 119).

■ Flash On

Select  (Flash On) as the flash mode when backlighting causes your subject to appear dark, even though there is enough light to keep the flash from firing automatically. This will cause the flash to fire and illuminate your subject whenever you press the shutter button (daylight synchro flash).

■ About Red-eye Reduction

Using the flash to record at night or in a dimly lit room can cause red spots inside the eyes of people who are in the image. This happens because the light from the flash reflects off of the retina of the eye.

▶▶ IMPORTANT! ◀◀

Note the following important points when using red-eye reduction.

- Red-eye reduction does not work unless the people in the image are looking directly at the camera during the pre-flash. Before pressing the shutter button, call out to the subjects so they all look at the camera while the pre-flash operation is performed.
- Red-eye reduction may not work very well if the subjects are located far away from the camera.

Flash Unit Status

You can find out the current flash unit status by pressing the shutter button half way and checking the monitor screen and operation lamp.

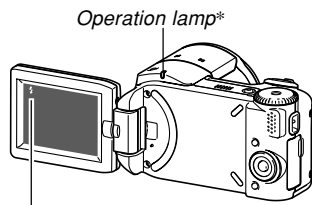

The  indicator is also shown on the monitor screen when the flash unit is ready to fire.

* Operation lamp

When the operation lamp is doing this:	It means this:
Flashing red	Flash unit is charging
Lit red	Flash unit is ready to fire

Changing the Flash Intensity Setting

Perform the following steps to change the flash intensity setting.

1. In a REC mode, press [MENU].
2. Use [◀] and [▶] to select the “REC” tab.
3. Use [▲] and [▼] to select “Flash Intensity”, and then press [▶].
4. Use [▲] and [▼] to select the setting you want, and then press [SET].

To make flash intensity:	Select this setting:
Stronger	+2
↑	+1
Normal	0
↓	-1
Weaker	-2

▶▶ IMPORTANT! ◀◀

- Flash intensity may not change if the subject is too far or too close to the camera.

Using Flash Assist

Recording a subject that is outside the flash range can cause the subject to appear dark in the resulting image, because not enough of the flash reaches the subject. When this happens, you can use flash assist to correct the brightness of the recorded subject, so it appears as if the flash illumination was sufficient.



Flash assist used



Flash assist not used

1. In a REC mode, press [MENU].
2. Use [◀] and [▶] to select the “REC” tab.
3. Use [▲] and [▼] to select “Flash Assist”, and then press [▶].

4. Use [▲] and [▼] to select “Auto”, and then press [SET].

- Selecting “Off” disables flash assist.



▶▶ IMPORTANT! ◀◀

- Flash assist may not produce the desired result for some types of subjects.
- Flash assist may have little effect on your image if you changed any of the following settings when you recorded it.
 - Flash intensity (page 72)
 - Exposure compensation (EV shift) (page 88)
 - ISO sensitivity (page 119)
 - Contrast (page 122)
- Using flash assist can cause an increase of digital noise in recorded images.

■ Flash Precautions

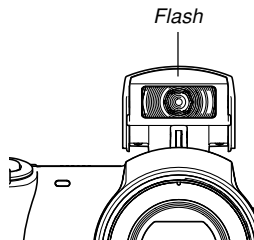
- Take care that your fingers do not block the flash when you hold the camera. Covering the flash with your finger can greatly reduce its effectiveness.
- Make sure your fingers do not interfere with operation of the flash unit. Positioning your finger over the flash unit can prevent it from opening and cause the flash to fail to fire.
- You may not be able to achieve the desired results using the flash if the subject is too close or too far away.
- The flash takes anywhere from a few seconds to as long as 12 seconds to attain full charge after being fired. The actual time required depends on the battery level, temperature, and other conditions.
- The flash does not fire in the modes listed below. The  (Flash Off) icon on the monitor screen indicates that flash is turned off.
Movie mode, Past Movie mode, Short Movie mode, MOVIE BEST SHOT mode





- The flash unit may not be able to charge when camera battery power is low. If this happens, the flash will not fire properly and you will not be able to obtain the desired exposure. Be sure to charge the camera's battery as soon as possible when power goes low.
- When the flash is turned off () , mount the camera on a tripod to record images in an area where available lighting is dim. Recording images under dim lighting without the flash can cause digital noise, which makes images appear coarse.
- When red-eye reduction () is selected, flash intensity is adjusted automatically in accordance with the exposure. The flash may not fire at all when the subject is brightly lit.
- Using flash in combination with another light source (daylight, fluorescent light, etc.) can result in abnormal image colors.

Using the Self-timer

The self-timer lets you select either a 2-second or 10-second delay of the shutter release after you press the shutter button. A Triple Self-timer feature lets you perform three consecutive self-timer operations to record three images.

1. In a REC mode, press [MENU].
2. Use [◀] and [▶] to select the “REC” tab.
3. Use [▲] and [▼] to select “Self-timer”, and then press [▶].
4. Use [▲] and [▼] to select the self-timer type you want to use, and then press [SET].
 - Selecting “Off” in step 4 disables the self-timer.

To do this:	Select this setting:
Specify a 10-second self-timer	 10 sec
Specify a 2-second self-timer	 2 sec
Specify Triple Self-timer	 X3
Disable the self-timer	Off

- This causes an indicator identifying the selected self-timer type to appear on the monitor screen.
- With the Triple Self-timer, the camera records a series of three images in the sequence described below.



BASIC IMAGE RECORDING

1. The camera performs a 10-second countdown and then records the first image.
2. The camera prepares to record the next image. The amount of time required for preparation depends on the camera's current "Size" and "Quality" settings, the type of memory (built-in or card) you are using for image storage, and whether or not the flash is charging.
3. After preparation is complete, the indicator "1sec" appears on the monitor screen, and another image is recorded one second later.
4. Steps 2 and 3 are repeated once more to record the third image.

5. Record the image.

- When you press the shutter button, the self-timer lamp flashes and the shutter releases after the self-timer reaches the end of its countdown (about 10 seconds or two seconds).
- You can interrupt an ongoing self-timer countdown by pressing the shutter button half way while the self-timer lamp is flashing. Pressing the shutter button all the way restarts the countdown from the beginning.

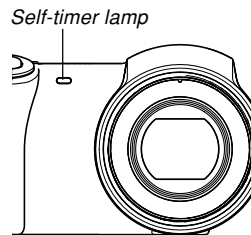

»» NOTE ««

- The “2 sec” self-timer setting is best when shooting with a slow shutter speed, because it helps to avoid blurring of images due to hand movement.
- The following functions are not available for use in combination with the self-timer.
Past Movie mode, Short Movie mode
- The following functions are not available for use in combination with the Triple Self-timer.
Movie mode, Past Movie mode, Short Movie mode, MOVIE BEST SHOT mode

Specifying Image Size

“Image size” is the size of the image, expressed as the number of vertical and horizontal pixels. A “pixel” is one of the many tiny dots that make up the image. More pixels provide finer detail when an image is printed, but a higher pixel count also causes the image’s file size to be larger. You can select an image size to suit your needs for greater detail or smaller file size.

Note that this setting is valid for snapshots only. For information about movie image size, see page 105.

1. In a REC mode, press [MENU].
2. Use [◀] and [▶] to select the “REC” tab.
3. Use [▲] and [▼] to select “Size”, and then press [▶].

4. Use [▲] and [▼] to select the setting you want, and then press [SET].

- When selecting the image size, the image size value (pixels) will alternate on the display with a corresponding print size. The print size indicates the optimum paper size when you print an image that is the image size you select.

Image Size	Print Size	
2560 × 1920	A3 Print	Larger
2560 × 1712 (3:2)	A3 Print (3:2 horizontal-to-vertical ratio)	
2048 × 1536	A4 Print	↕
1600 × 1200	3.5" × 5" Print • More detail than 1280 × 960	
1280 × 960	3.5" × 5" Print	
640 × 480	E-mail (optimum size when attaching image to e-mail)	Smaller

- The above print sizes are all approximate values when printing at a resolution of 200 dpi (dots per inch). Use a larger setting when you want to print at a higher resolution or when you plan to produce a larger size print.
- Selecting the "2560 × 1712 (3:2)" image size will record images with a 3:2 (horizontal : vertical) aspect ratio, which is optimal for printing on paper with an aspect ratio of 3:2.

Specifying Image Quality

Compressing an image before storage can cause a deterioration of its quality. The more an image is compressed, the greater the loss of quality. The image quality setting specifies the compression ratio to be used when an image is stored in memory. You can select an image quality setting to suit your needs for higher quality or smaller file size.

Note that this setting is valid for snapshots only. For information about movie image quality, see page 105.

1. In a REC mode, press [MENU].
2. Use [◀] and [▶] to select the “REC” tab.
3. Use [▲] and [▼] to select “ Quality”, and then press [▶].
4. Use [▲] and [▼] to select the setting you want, and then press [SET].

To get this:	Select this setting:	
High image quality, large file size	Fine	Higher Quality
Normal image quality and normal file size	Normal	↑ ↓
Low image quality, small file size	Economy	Lower Quality

▶▶ IMPORTANT! ◀◀

- Actual file size depends on the type of image you record. This means that the remaining image capacity noted on the monitor screen may not be exactly accurate (pages 29, 231).

OTHER RECORDING FUNCTIONS

Selecting the Focus Mode

You can select one of five different focus modes: Auto Focus, Macro, Pan Focus, Infinity, and Manual Focus.

1. In a REC mode, press [🌸].

- Each press of [🌸] cycles through the focus mode settings in the sequence shown below.

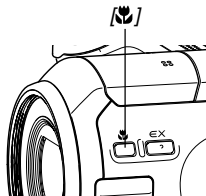

Focus mode indicator

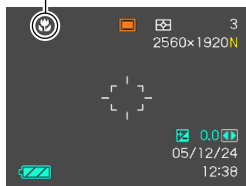

To set up the camera to do this:	Select this setting:
Focus automatically (Auto Focus)*1	None
Perform close-up focus (Macro)	
Fix the focal distance (Pan Focus)*2	PF
Perform infinity focus (Infinity)	
Focus manually (Manual Focus)	MF

*1 When using Icon Help (page 124), select “**AF** Auto Focus”.

*2 “**PF**” (Pan Focus) can be selected in a movie mode (Movie, Past Movie, Short Movie, MOVIE BEST SHOT) only.

Using Auto Focus

As its name suggests, Auto Focus focuses the image automatically. The automatic focus operation starts when you press the shutter button down half way. The following is the Auto Focus range.

Range: Snapshots: 40cm to ∞ (1.3' to ∞)

Movies: 10cm to ∞ (0.3' to ∞)

- Using optical zoom causes the above ranges to change.

1. Press **[M]** to cycle through the focus mode settings until there is no focus mode indicator on the display.

- When using Icon Help (page 124), select “**AF** Auto Focus”.

2. Compose the image so the main subject is within the focus frame, and then press the shutter button half way.

- You can tell whether the image is focused by observing the focus frame and the operation lamp.

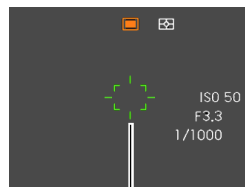

Focus frame

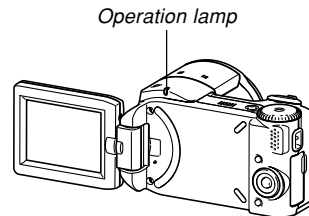

When you see this:	It means this:
Green focus frame Green operation lamp	The image is focused.
Red focus frame Flashing green operation lamp	The image is not focused.

3. Press the shutter button the rest of the way to record the image.

NOTE

- When proper focusing is not possible because the subject is closer than the Auto Focus range, the camera automatically switches to the Macro mode range (page 84).
- Whenever you perform an optical zoom operation (page 66) while recording with Auto Focus, a value will appear on the monitor screen as shown below to tell you the focusing range.
Example: AF 40cm - ∞

■ Specifying the Auto Focus Area

You can use the following procedure to change the Auto Focus area used in the Auto Focus mode and the Macro mode. Note that the configuration of the focus frame changes in accordance with the Auto Focus area you select.

1. In a REC mode, press [MENU].
2. On the “REC” tab, select “AF Area”, and then press [▶].
3. Use [▲] and [▼] to select the Auto Focus area you want, and then press [SET].

OTHER RECORDING FUNCTIONS

For this type of Auto Focus area:	Select this:
<p>Very limited range in the center of the screen</p> <ul style="list-style-type: none"> This setting works well with focus lock (page 87). 	Spot
<p>Automatic selection of the focus area where the subject closest to the camera is located</p> <ul style="list-style-type: none"> With this setting, a wide focus frame, which contains seven focus points, appears on the monitor screen first. When you press the shutter button half way, the camera automatically selects the focus point where the subject closest to the camera is located, and a focus frame appears at that point. This setting works well for group photos. 	Multi
<p>Free movement of the focus point location you want.</p> <ul style="list-style-type: none"> Selecting this setting initially displays the focus point in the center of the monitor screen. Then you can use the [▲], [▼], [◀], and [▶] keys to move it to the location you want. Finally, press [SET] to select the current focus point location. 	Free

• Spot

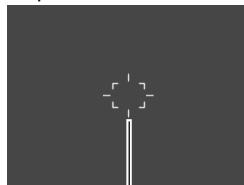

Focus frame

• Multi

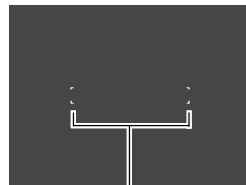

Focus frame

• Free

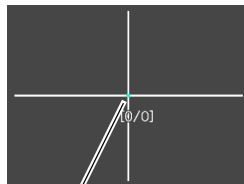

Focus point

→
[SET]

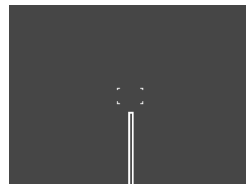

Focus frame

Using the Macro Mode

Use the Macro mode when you need to focus on close up subjects. The following shows the approximate focus range in the Macro mode.

Range: 1cm to 50cm (0.4" to 19.7")

- Using optical zoom causes the above range to change.

1. Press [M] to cycle through the focus mode settings until "M" is shown as the focus mode indicator.

2. Record the image.

- The focus and image recording operations are identical to those in the Auto Focus mode.

NOTE

- When the Macro mode cannot focus properly because the subject is too far away, the camera automatically switches to the Auto Focus range (page 81).
- Whenever you perform an optical zoom operation (page 66) while recording with the Macro mode, a value will appear on the monitor screen as shown below to tell you the focusing range.
Example: M 1cm - 50cm

IMPORTANT!

- Use of the flash along with the Macro mode can cause the light of the flash to become blocked, which can produce unwanted shadows in your image.

Using Pan Focus

Pan Focus can be used in a movie mode (Movie, Past Movie, Short Movie, MOVIE BEST SHOT) to focus on a particular subject and record without using Auto Focus. Pan Focus comes in handy when recording under conditions where Auto Focus is difficult for some reason, or in cases where Auto Focus operation noise is too noticeable in the movie audio.

1. Enter a movie mode (page 59).

- You can perform this procedure in the Movie, Past Movie, Short Movie, or MOVIE BEST SHOT mode.

2. Press [3. Press the shutter button to record the movie with Pan Focus.

▶▶ IMPORTANT! ◀◀

- Pan Focus can be used in a movie mode (Movie, Past Movie, Short Movie, or MOVIE BEST SHOT) only. It is disabled in all other modes.

▶▶ NOTE ◀◀

- Whenever you perform an optical zoom operation (page 66) while recording with pan focus, a value will appear on the monitor screen as shown below to tell you the focusing range.

Example: PF 0.4m - ∞

Using the Infinity Mode

The Infinity mode fixes focus at infinity (∞). Use this mode when recording scenery and other faraway images.

1. Press [2. Record the image.

Using Manual Focus

With the Manual Focus mode, you can adjust the focus of an image manually. The following shows focus range in the Manual Focus mode.

Range: 1cm (0.4") to infinity (∞)

- Using optical zoom causes the above range to change.

- Press [MF] to cycle through the focus mode settings until "MF" is shown as the focus mode indicator.

- At this point, a boundary also appears on the display, indicating the part of the image that will be used for manual focus.

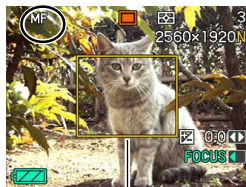

Boundary

- While watching the image on the monitor screen, use [◀] and [▶] to focus.

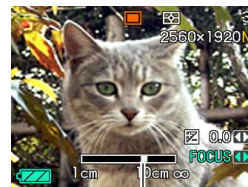

Manual focus position

To do this:	Do this:
Focus in on the subject	Press [◀].
Focus out on the subject	Press [▶].

- Pressing [◀] or [▶] causes the area inside of the boundary displayed in step 1 to fill the monitor screen momentarily to aid in focus. The normal image will reappear a short while later.

- Press the shutter button to record the image.

▶▶ IMPORTANT! ◀◀

- In the Manual Focus mode, the [◀] and [▶] keys adjust focus, even if you used key customization to assign other functions to them (page 125).

▶▶ NOTE ◀◀

- Whenever you perform an optical zoom operation (page 66) while recording with manual focus, a value will appear on the monitor screen as shown below to tell you the focusing range.

Example: MF 1cm - ∞

Using Focus Lock

Focus lock is a technique you can use to focus on a subject that is not located within the focus frame when you record an image. You can use focus lock in the Auto Focus mode and the Macro mode (📷).

1. Using the monitor screen, compose the image so the main subject is within the focus frame, and then press the shutter button half way.

- This locks the focus on the subject that is currently within the focus frame.

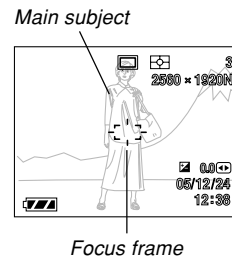

OTHER RECORDING FUNCTIONS

2. Keeping the shutter button pressed half way down, re-compose the image as you like.

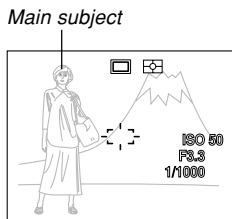

3. When the image is composed the way you want, press the shutter button the rest of the way to record it.

- The focus and image recording operations are identical to those in the Auto Focus mode.

NOTE

- Locking the focus also locks the exposure.

Exposure Compensation (EV Shift)

Exposure compensation lets you change the exposure setting (EV value) manually to adjust for the lighting of your subject. This feature helps to achieve better results when recording a backlit subject, a strongly lit subject indoors, or a subject that is against a dark background.

EV Shift Range: -2.0EV to $+2.0\text{EV}$

Steps: $1/3\text{EV}$

1. In a REC mode, press [MENU].

2. Select the “REC” tab, select “EV Shift”, and then press [▶].



Exposure compensation value

OTHER RECORDING FUNCTIONS

3. Use [▲] and [▼] to change the exposure compensation value, and then press [SET].

- Pressing [SET] registers the displayed value.



EV value

[▲] : Increases the EV value. A higher EV value is best used for light-colored subjects and backlight subjects.

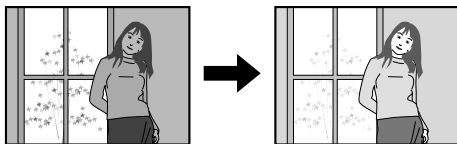

[▼] : Decreases the EV value. A lower EV value is best for dark-color subjects and for shooting outdoors on a clear day.

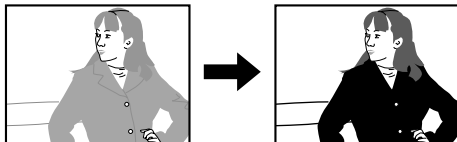

- To cancel EV Shift, adjust the value until it becomes 0.0.

4. Record the image.

▶▶ IMPORTANT! ◀◀

- When shooting under very dark or very bright conditions, you may not be able to obtain satisfactory results even after performing exposure compensation.

▶▶ NOTE ◀◀

- Performing an EV shift operation while using multi-pattern metering (page 120) will cause the metering mode to switch automatically to center weighted metering. Returning the EV shift value to 0.0 causes the metering mode to change back to multi-pattern metering.
- You can use key customization (page 125) to configure the camera to perform exposure compensation whenever you press [◀] or [▶] while in a REC mode. This comes in handy when adjusting exposure compensation while viewing the on-screen histogram (page 116).

Using the Built-in ND Filter

An ND filter reduces the amount of light entering the lens. The built-in ND filter of this camera reduces light by 2.0 Exposure Values (EV). The ND filter is available in the following modes.

A Mode: Aperture Priority AE (page 94)

Using the ND filter in this mode increases the shutter speed value by two steps (making shutter speed slower). Use the ND filter in this mode when lighting is bright and you want to use a wide aperture in order to blur the background, etc.

M Mode: Manual Exposure (page 97)

Using the ND filter in this mode results in exposure that is 2.0 EV darker than the unfiltered setting. Because of this, you should readjust aperture and shutter speed to obtain appropriate exposure.

To turn the ND filter on and off

Example: M Mode (manual exposure)

1. Use **[▲]** and **[▼]** to select the ND filter value in the exposure panel, and then use **[◀]** and **[▶]** to change the setting.



NOTE

- The ND filter is turned on or off automatically in the following modes. Snapshot (Auto), S Mode (Shutter Speed Priority AE), BEST SHOT Mode, Movie, Short Movie, Past Movie, MOVIE BEST SHOT
- Pressing the shutter button half way while the ND filter is turned on causes the ND indicator to appear on the display.

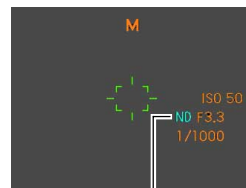

Indicates ND filter is on.

Adjusting White Balance

The wavelengths of the light produced by various light sources (daylight, light bulb, etc.) can affect the color of a subject when it is recorded. White balance lets you make adjustments to compensate for different lighting types, so the colors of an image appear more natural.

1. In a REC mode, press [MENU].
2. Select the “REC” tab, select “White Balance”, and then press [▶].

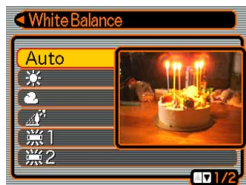

3. Use [▲] and [▼] to select the setting you want, and then press [SET].

When shooting under these conditions:	Select this setting:
Normal conditions	Auto
Outdoor daylight on a clear day	
Outdoor daylight on an overcast or rainy day, in the shade of a tree, etc.	
In the shade of a building or any other area where the color temperature is high	
Under white or daylight white fluorescent light (suppresses color fogging)	
Under daylight fluorescent light (suppresses color fogging)	
Under incandescent lighting	
Other multiple light sources that cause a bluish tinge to appear in areas covered by the flash	
Difficult lighting that requires manual control (See “Configuring the White Balance Setting Manually” (page 92).)	Manual

»» NOTE ««

- When “Auto” is selected for the white balance setting, the camera automatically determines the white point of the subject. Certain subject colors and light source conditions can cause problems when the camera tries to determine the white point, which makes proper white balance adjustment impossible. When this happens, use daylight, cloudy, or one of the other fixed white balance settings to specify the type of lighting available.
- You can use the key customization feature (page 125) to configure the camera so the white balance setting changes whenever you press [◀] or [▶] while in a REC mode.
- If you have key customization configured to control white balance and you have Icon Help turned on (page 124), select “**AWB** Auto WB” to change the white balance mode to auto.

Configuring the White Balance Setting Manually

Certain complex light sources or other environmental conditions can make it impossible to obtain good results when “Auto” or one of the fixed light source settings is selected for white balance. Manual white balance lets you configure the camera for a particular light source and other conditions.

Note that you must perform manual white balance under the same conditions you will be shooting under. Have a sheet of white paper on hand before starting the following procedure.

- 1. In a REC mode, press [MENU].**
- 2. Select a “REC” tab, select “White Balance”, and then press [▶].**

OTHER RECORDING FUNCTIONS

3. Use [▲] and [▼] to select “Manual”.

- This causes the object you last used to adjust manual white balance to appear on the monitor screen. If you want to use the same settings you configured during a previous manual white balance setting operation, skip step 4 and perform step 5.



4. Point the camera at a white paper or similar object under the lighting conditions for which you want to set the white balance, and then press the shutter button.

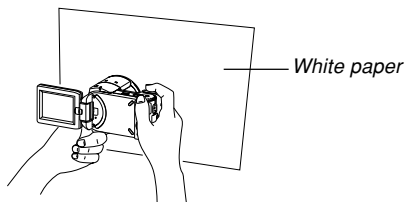

- This starts the white balance adjustment procedure. The message “Complete” appears on the monitor screen after white balance adjustment is complete.

5. Press [SET].

- This registers the white balance settings and returns to the currently selected recording mode.

NOTE

- After you adjust white balance manually, the setting remains in effect until you change it or until you turn off the camera.

Specifying the Exposure Mode

You can use the mode dial to select the exposure mode, which controls the aperture and shutter speed settings used during image recording.

A mode : Aperture Priority AE

S mode : Shutter Speed Priority AE

M mode : Manual Exposure

Using Aperture Priority AE

When A mode (aperture priority AE) is selected as the exposure mode, the camera adjusts the shutter speed automatically in accordance with a fixed aperture value specified by you. A wider aperture (a lower aperture value) provides a shallow depth of field, while a small aperture (a higher aperture value) provides a greater depth of field. The shutter speed range in this mode is 1/2000 to 1/8 second.

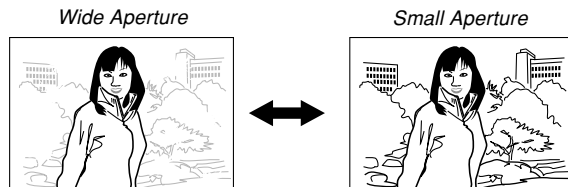

1. Align the mode dial with "A" (Aperture Priority).

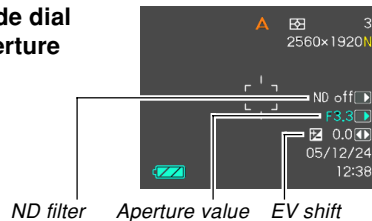

ND filter

Aperture value

EV shift

- 2. Use [▲] and [▼] to select the aperture value (page 31) in the exposure panel, and then use [◀] and [▶] to change the setting.**

Aperture value*	Wide ←→ Small
	F3.3 , 3.7 , 4.4 , 5.2 , 6.2 , 7.4
Depth of Field	Shallow ←→ Deep

* The above values are full wide angle optical zoom. Aperture values are different at other optical zoom settings.

- Use [▲] and [▼] to select “ND”, and then use [◀] and [▶] to turn the ND filter on or off (pages 30, 90).
- You could also use [▲] and [▼] to select “EV Shift” here, and then use [◀] and [▶] to specify an exposure compensation value (pages 31, 88).
- If you are using manual focus (pages 31, 86), you can also use [▲] and [▼] to select “FOCUS” (manual focus adjustment), and then use [◀] and [▶] to focus manually.

- 3. Press the shutter button half way.**

- This causes the camera to configure shutter speed automatically in accordance with the aperture value you selected. Then it focuses the image.
- The shutter speed and aperture values on the monitor screen will turn amber when you press the shutter button half way if the image is over-exposed or under-exposed.

- 4. When the image is focused, press the shutter button all the way down to record.**

Using Shutter Speed Priority AE

When S mode (shutter speed priority AE) is selected as the exposure mode, the camera adjusts the aperture automatically in accordance with a fixed shutter speed specified by you. You should specify a shutter speed in accordance with how much your subject is moving.

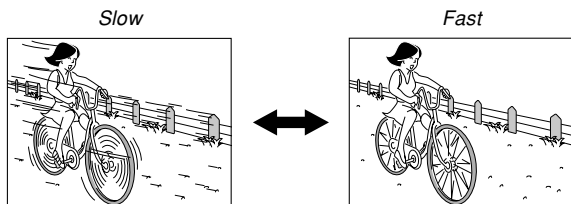

1. Align the mode dial with “S” (Shutter Speed Priority).

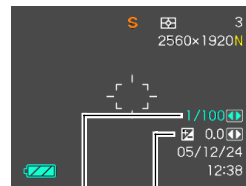

Shutter speed EV shift

2. Use [▲] and [▼] to select the shutter speed value (page 31) in the exposure panel, and then use [◀] and [▶] to change the setting.

Shutter speed	Slow ←→ Fast
	60 seconds ←→ 1/2000 second
Movement	Blurred ←→ Stopped

- You could also use [▲] and [▼] to select “EV Shift” here, and then use [◀] and [▶] to specify an exposure compensation value (pages 31, 88).
- If you are using manual focus (pages 31, 86), you can also use [▲] and [▼] to select “FOCUS” (manual focus adjustment), and then use [◀] and [▶] to focus manually.

3. Press the shutter button half way.

- This causes the camera to configure the aperture value automatically in accordance with the shutter speed you selected. Then it focuses the image.
- The shutter speed and aperture values on the monitor screen will turn amber when you press the shutter button half way if the image is over-exposed or under-exposed.

4. When the image is focused, press the shutter button all the way down to record.**Setting Exposure Settings Manually**

In the M mode (manual exposure), you can adjust shutter speed and aperture manually.

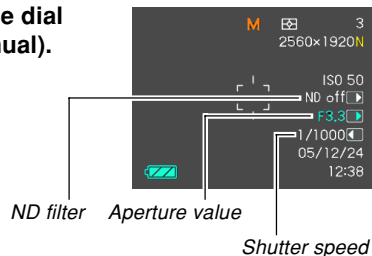
1. Align the mode dial with “M” (Manual).

2. Use [▲] and [▼] to select “ND”, and then use [◀] and [▶] to turn the ND filter (pages 31, 90) on or off, if you want.

- 3. Use [▲] and [▼] to select the aperture value (page 31) in the exposure panel, and then use [◀] and [▶] to change the setting.**

Aperture value*	Wide ←→ Small
	F3.3 , 3.7 , 4.4 , 5.2 , 6.2 , 7.4
Depth of Field	Shallow ←→ Deep

* The above values are full wide angle optical zoom. Aperture values are different at other optical zoom settings.

- 4. Use [▲] and [▼] to select the shutter speed value (page 31) in the exposure panel, and then use [◀] and [▶] to change the setting.**

Shutter speed	Slow ←→ Fast
	60 seconds ←→ 1/2000 second
Movement	Blurred ←→ Stopped

- If you are using manual focus (pages 31, 86), you can also use [▲] and [▼] to select “FOCUS” (manual focus adjustment), and then use [◀] and [▶] to focus manually.

- 5. Press the shutter button half way.**

- This causes the camera to adjust focus automatically.

- 6. When the image is focused, press the shutter button all the way down to record.**

Using Manual Assist On-screen Guidance

Pressing [SET] while in the A mode (aperture priority AE), S mode (shutter speed priority AE), or M mode (manual exposure) causes on-screen guidance and exposure indicators (aperture and shutter speed) to appear on the display.

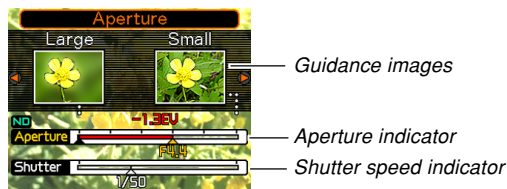

- In the A mode, you can use [◀] and [▶] to change the aperture value setting. Pressing a button causes the Guidance images to disappear from the display.
- In the S mode, you can use [◀] and [▶] to change the shutter speed setting. Pressing a button causes the Guidance images to disappear from the display.
- In the M mode, you can use [▲] and [▼] to switch the Guidance images between the aperture value and shutter speed settings. After displaying the screen you want, you can use [◀] and [▶] to change the setting.
- If the Guidance images disappear from the monitor screen, you can display them again by pressing [DISP].

▶▶ IMPORTANT! ◀◀

- The shutter speed displayed in the A mode and the aperture value displayed in the S mode are rough approximations only. Because of this, these settings may be slightly different from the settings that appear when you press the shutter button half way (which are more precise).

Exposure Mode Recording Precautions

- You may not be able to achieve the brightness you want when recording an image that is very dark or very bright. If this happens, use the M mode (manual exposure) to adjust the aperture or shutter speed manually.
- Using slow shutter speeds can cause digital noise (graininess) to appear in the image. Because of this, the camera automatically performs a digital noise reduction process whenever the shutter speed is 1/8 second or slower. The slower the shutter speed, the greater the possibility that digital noise will be generated in an image. If you notice digital noise in your images at very slow shutter speeds, try using a shutter speed setting that is faster than four seconds. Also note that the digital noise reduction process can cause it to take longer (about double the shutter speed setting or more) to record each image.
- At shutter speeds slower than 1 second, the brightness of the recorded image may not be the same as the brightness of the image that appears on the monitor screen.

Using the BEST SHOT Mode

Selecting one of the 22 BEST SHOT scenes automatically sets up the camera for recording a similar type of image.

Scene Number	Scene Name
1	Portrait
2	Scenery
3	Portrait With Scenery
4	Children
5	Sports
6	Candlelight Portrait
7	Party
8	Pet
9	Flower
10	Natural Green
11	Soft Flowing Water
12	Splashing Water
13	Sundown
14	Night Scene
15	Night Scene Portrait
16	Fireworks
17	Food
18	Text
19	Collection
20	Monochrome
21	Retro

OTHER RECORDING FUNCTIONS

Scene Number	Scene Name
22	Twilight
	Register User Scene (page 102)

1. Align the mode dial with “BS”, and then press [SET].

- This enters the BEST SHOT mode and displays a sample scene.



2. Use [◀] and [▶] to select the sample scene you want, and then press [SET].

- If you want to check which sample scene is currently selected or if you want to change to a different scene, press [SET] again.

3. Record the image.

▶▶ IMPORTANT! ◀◀

- BEST SHOT scenes were not recorded using this camera. They are provided as samples only.
- Due to shooting conditions and other factors, an image recorded using the setup of a BEST SHOT scene may not produce exactly the results you expect.
- You can change the camera settings that are made when you select a BEST SHOT scene. Note, however, that the BEST SHOT settings revert to their defaults when you select another BEST SHOT scene or turn off the camera. If you want to save your settings for later use, save them as a BEST SHOT user setup.
- Digital noise reduction processing is performed automatically when you are recording a night scene, fireworks, or other image that requires slow shutter speeds. Because of this, it takes longer to record images at lower shutter speeds. Make sure that you do not perform any camera button operations until the image recording operation is complete.
- When recording the image of a night scene, fireworks, or some other image using a slow shutter speed, use of a tripod is recommended to prevent hand movement.

»» NOTE ««

- Operation guidance and the currently selected BEST SHOT scene appear on the display for about two seconds if the camera is in the BEST SHOT mode when you turn it on.

Creating Your Own BEST SHOT Setup

You can use the procedure below to save the setup of an image you recorded as a BEST SHOT scene. After that, you can recall the setup whenever you want to use it.

1. Align the mode dial with “**BS**”, and then press [SET].
 - This enters the BEST SHOT mode and displays a sample scene.
2. Use [◀] and [▶] to display “Register User Scene”.
 

Registers a new user scene. Press the SET key to start image selection.
3. Press [SET].
4. Use [◀] and [▶] to display the image whose setup you want to register as a BEST SHOT scene.
 

5. Use [▲] and [▼] to select “Save”, and then press [SET].

- This registers the setup. Now you can use the procedure on page 101 to select your user setup for recording.

▶▶ IMPORTANT! ◀◀

- BEST SHOT user setups are located in the camera's built-in memory following the built-in sample scenes.
- Note that formatting built-in memory (page 165) deletes all BEST SHOT user setups.

▶▶ NOTE ◀◀

- The following are the settings that are included in a BEST SHOT user setup: focus mode, EV shift value, filter, metering mode, white balance mode, flash intensity, sharpness, saturation, contrast, flash mode, ISO sensitivity, Flash Assist, aperture, shutter speed and ND filter.
- Note that images recorded with this camera only can be used to create a BEST SHOT user setup.
- You can have up to 999 BEST SHOT user setups in the camera's built-in memory at one time.
- You can check the current setup of a scene by displaying the various setting menus.
- When you register a BEST SHOT user setup, it is automatically assigned a file name using the format shown below, and stored in the “SCENE” folder.
UP505nnn.JPE (n = 0 to 9)

To delete a BEST SHOT user setup





1. Align the mode dial with “**ES**”, and then press [SET].
2. Use [◀] and [▶] to display the user setup you want to delete.
3. Press [▼] (📄) to delete the user setup.
4. Use [▲] and [▼] to select “Delete”.
5. Press [SET] to delete the file.
6. Press [MENU].

Recording a Movie

You can record high-resolution movies with stereo sound. Movie length is limited only by the amount of memory available for storage. You can select a resolution setting to suit your needs, and a variety of different movie modes provide plenty of movie making versatility.

- File Format: MPEG-4 AVI format
- Maximum Movie Length
 - The length of a movie is limited only by the amount of memory available to store it.

OTHER RECORDING FUNCTIONS

- Versatile Movie Recording Modes
 -  Movie mode
Use this mode for normal movie recording (page 106).
 -  Past Movie mode
This mode uses a 5-second buffer that is continually updated. Pressing the shutter button starts recording from five seconds prior to the point the button is pressed. Use this mode when you want to make sure you do not miss fast-moving action (page 107).
 -  Short Movie mode
Each press of the shutter button in this mode records a short movie that starts before the button is pressed and ends after the button is pressed (page 108).
 -  MOVIE BEST SHOT mode
This mode makes camera setup as easy as selecting the applicable sample scene. Select one of the MOVIE BEST SHOT scenes and the camera automatically configures itself with the setup for that scene (page 111).

NOTE

- You can play movie files on your computer using Windows Media Player 9.

Specifying Movie Image Quality

The image quality setting determines how much the camera compresses movie images before storing them. Image quality is expressed as image size in pixels. A “pixel” is one of the many tiny dots that make up an image. More pixels (a larger image size) provide finer detail and higher image quality when a movie is played back. Before recording a movie, select the image quality setting that suits your needs.

1. In a REC mode, press [MENU].
2. Use [◀] and [▶] to select the “REC” tab.
3. Use [▲] and [▼] to select “ Quality”, and then press [▶].
4. Use [▲] and [▼] to select the setting you want, and then press [SET].

OTHER RECORDING FUNCTIONS

Setting		Approximate Data Rate	Frame Rate
Higher Quality	HQ (640 × 480 pixels)	4.2 megabits per second	30 frames/second
↕	Normal (640 × 480 pixels)	2.2 megabits per second	30 frames/second
Lower Quality	LP (320 × 240 pixels)	790 kilobits per second	15 frames/second

Recording a Standard Movie (Movie Mode)

Use the Movie Mode when you want to record a standard movie.

1. Align the mode dial with “M”.

- This enters the Movie mode and causes “M” to appear on the monitor screen.



2. Point the camera at the subject and then press the shutter button.

- Movie recording continues as long as remaining memory capacity allows.



3. To stop movie recording, press the shutter button again.

- When movie recording is complete, the movie file is stored in file memory.

Recording Past Action (Past Movie Mode)

This mode uses a 5-second buffer that is continually updated. Pressing the shutter button starts recording from five seconds prior to the point the button is pressed. Use this mode when you want to make sure you do not miss fast-moving action.

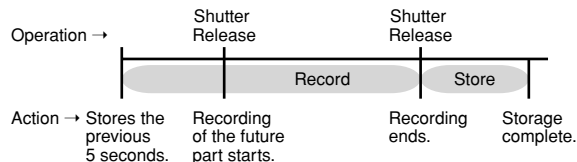

1. Align the mode dial with “”.

- This enters the Past Movie Mode and causes “” to appear on the monitor screen.

2. Point the camera at the subject and then press the shutter button.

- This will record anything that went on in front of the lens during the previous five seconds and continue recording from the point that the shutter button was pressed. Recording can continue as long as there is memory available to store data.

3. To stop recording, press the shutter button again.

Recording a Short Movie (Short Movie Mode)

The Short Movie Mode records a movie of preset length each time you press the shutter button.

A Short Movie Mode movie consists basically of two parts, as shown in the illustration below.

- When 4-second past part and 4-second future part is specified

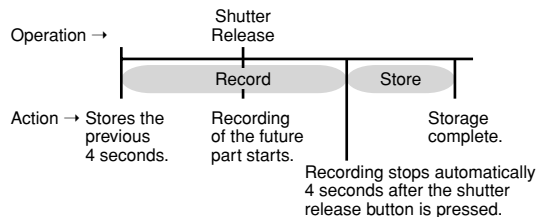

You can specify the length of the past part and the future part independently. The total length of the short movie can be anywhere from two to eight seconds. A MOTION PRINT feature (page 141) lets you capture still images from a short movie as you store it.

■ To record a Short Movie Mode movie

1. Align the mode dial with “”.

- This enters the Short Movie Mode and causes “” to appear on the monitor screen.



2. Press [SET].

3. Use [\blacktriangle] and [\blacktriangledown] to specify the length of the past part (the part before the shutter button is pressed), and then press [\blacktriangleright].

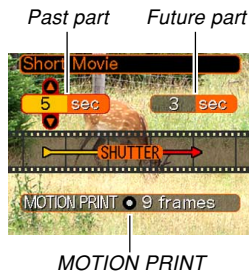
- Times can be specified in one-second units.
- The total short movie length (past part plus future part) can be the range of two seconds to eight seconds.
- You can specify 0 seconds for the length of the past part or the future part.
- The length of the past part can be from 0 to five seconds.



4. Use [\blacktriangle] and [\blacktriangledown] to specify the length of the future part (the part after the shutter button is pressed), and then press [\blacktriangleright].
5. Use [\blacktriangle] and [\blacktriangledown] to select the MOTION PRINT layout format you want, and then press [SET].

To do this:		Select this setting:
Store a capture of the image at the point the shutter button is pressed to start Short Movie Mode recording, and display it on a background of eight frames		9 frames
Store a capture of the image at the point the shutter button is pressed to start Short Movie Mode recording		1 frame
Turn off MOTION PRINT (no snapshot stored)		Off



6. Point the camera at the subject and then press the shutter button.

- This will record a movie of the length specified by the time values you specified in steps 3 and 4. Recording stops automatically.
- To stop recording part way through, press the shutter button again.

▶▶ IMPORTANT! ◀◀

- Note that in the Short Movie Mode, movie data is continually recorded and stored in a buffer before you press the shutter button. Be sure to keep the camera still and pointed in the direction of the subject for some time before you press the shutter button to start recording.
- When a Short Movie Mode record operation starts future part recording, the monitor screen will show a countdown of the remaining recording time. Recording continues until the end of the countdown is reached.

■ Movie Recording Precautions

- The flash does not fire in the Movie mode.
- This camera also records audio. Note the following points when recording a movie.
 - Take care that you do not block the stereo microphones with your fingers.
 - Good recording results are not possible when the camera is too far from the subject.
 - Operating camera buttons during recording can cause button noise to be included in the audio.
 - Movie audio is recorded in stereo.
- Very bright light inside of an image can cause a vertical band to appear in the monitor screen image. This is a CCD phenomenon known as “vertical smear”, and does not indicate malfunction of the camera. Note that vertical smear is not recorded with the image in the case of a snapshot, but it is recorded in the case of a movie.
- Certain types of memory cards take longer to record data, which can cause movie frames to be dropped.  and  flash on the monitor screen during recording to let you know when a frame has been dropped.

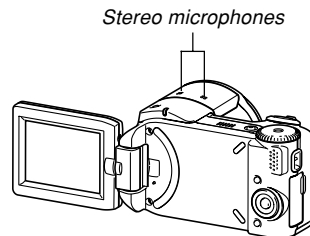

OTHER RECORDING FUNCTIONS

- The effects of camera movement in an image become more pronounced when you record close ups or recording with a large zoom factor. Because of this, use of a tripod is recommended when recording close ups or recording with a large zoom factor.
- Images may be out of focus if the subject is outside the shooting range of the camera.
- Certain types of subjects are difficult to focus (page 65) and may cause blurry images. If this happens, try changing the focus mode to Manual Focus (page 86) or Pan Focus (page 85).
- If images are out of focus when using Auto Focus, you may be able to achieve proper focus by pointing the camera at another subject momentarily.
- Performing zoom, Auto Focus, or other operations during recording can cause operation noise to be recorded in the movie audio. Auto Focus operation noise can be eliminated by selecting Manual Focus (page 86) or Pan Focus (page 85) as the focus mode, because Auto Focus is not performed in these modes.

Instant Movie Setups (MOVIE BEST SHOT Mode)

Selecting one of the MOVIE BEST SHOT sample scenes automatically sets up the camera for recording a similar type of movie.

- 1. Align the mode dial with “

111**

►► IMPORTANT! ◀◀

- MOVIE BEST SHOT scenes were not recorded using this camera. They are provided as samples only.
- Images recorded using a MOVIE BEST SHOT scene may not produce the results you expected due to shooting conditions and other factors.
- You can change the camera settings that are made when you select a MOVIE BEST SHOT scene. Note, however, that the MOVIE BEST SHOT settings revert to their defaults when you select another MOVIE BEST SHOT scene, change the recording mode, or turn off the camera. If you want to save your settings for later use, save them as a MOVIE BEST SHOT user setup.

►► NOTE ◀◀

- Turning on the camera while it is in the MOVIE BEST SHOT Mode will cause operation guidance and the currently selected sample scene to appear on the monitor screen for about two seconds.

Creating Your Own MOVIE BEST SHOT Setup

You can use the procedure below to save the setup of a movie you recorded as a MOVIE BEST SHOT scene. After that, you can recall the setup whenever you want to use it.

- 1. Align the mode dial with “”, and then press [SET].**
 - This enters the MOVIE BEST SHOT Mode and displays a sample scene.
- 2. Use [◀] and [▶] to display “Register User Scene”.**
- 3. Press [SET].**
- 4. Use [◀] and [▶] to display the movie whose setup you want to save.**
- 5. Use [▲] and [▼] to select “Save”, and then press [SET].**
 - The normal MOVIE BEST SHOT screen will reappear after the save operation is complete. Now you can use the procedure on page 111 to select your user setup for recording.

▶▶ IMPORTANT! ◀◀

- When selecting a user setup, scroll to the end of the built-in MOVIE BEST SHOT scenes until “Recall User Scene” appears on the display. Then scroll further to see the user setup scenes.
- Formatting the camera’s built-in memory (page 165) deletes all user MOVIE BEST SHOT setups.
- The following are the settings that are included in a MOVIE BEST SHOT user setup.
Focus mode, white balance mode, sharpness, saturation, contrast, filter, EV shift
- Only the setup of a movie recorded with this camera can be saved as a MOVIE BEST SHOT setup.
- You can register up to 999 MOVIE BEST SHOT user setups.
- You can check the settings of the currently selected MOVIE BEST SHOT scene by displaying the various setting menus.
- MOVIE BEST SHOT user setups are stored in camera built-in memory in the folder named “MSCENE”. File names are assigned automatically using the format shown below.
UP505nnn.JPE (n = 0 to 9)

■ To delete a MOVIE BEST SHOT user setup

1. In the MOVIE BEST SHOT Mode, press [SET].
2. Use [◀] and [▶] to scroll through user setups until the one you want to delete is displayed.
3. Press [▼] (🗑️).
4. Use [▲] and [▼] to select “Delete”, and then press [SET].
5. Press [MENU].

Recording Audio

Adding Audio to a Snapshot

You can add audio to a snapshot after you record it.

- **Image Format: JPEG**
JPEG is an image format that provides efficient data compression.
The file extension of a JPEG file is “.JPG”.
- **Audio Format: WAVE/ADPCM recording format**
This is the Windows standard format for audio recording.
The file extension of a WAVE/ADPCM file is “.WAV”.
- **Recording Time:**
Up to about 30 seconds per image
- **Audio File Size:**
Approximately 120KB (30-second recording of approximately 4KB per second)

NOTE

- You can play back an audio file recorded in the Audio Snapshot mode on your computer using Windows Media Player.

1. In a REC mode, press [MENU].
2. Select the “REC” tab, select “Audio Snap”, and then press [▶].
3. Use [▲] and [▼] to select “On” and then press [SET].
 - This enters the Audio Snapshot mode.
 - Selecting “Off” enters the Normal Snapshot mode (no audio).

4. Press the shutter button to record the image.

- After the image is recorded, the camera enters audio recording standby, with the image you just recorded on the monitor screen and displays a  indicator.
- You can cancel audio recording standby by pressing [MENU].



Remaining recording time

5. Press the shutter button to start audio recording.

- The operation lamp flashes green while recording is in progress.

6. Recording stops after about 30 seconds or when you press the shutter button.

▶▶ IMPORTANT! ◀◀

- The Audio Snapshot mode is unavailable during image recording using Triple Self-timer.

■ Audio Recording Precautions

- Take care that you do not block the stereo microphones with your fingers.

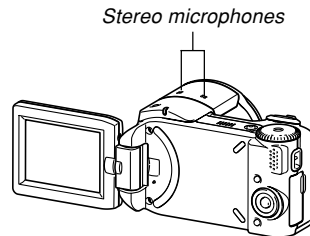

- Good recording results are not possible when the camera is too far from the subject.
- Pressing the power button or rotating the mode dial stops recording and stores any audio recorded up to that point.
- You can also perform “after-recording” to add audio to a snapshot after recording it, and also change the audio recorded for an image. See page 147 for more information.

Using the Histogram

You can use the [DISP] button to display a histogram on the monitor screen. The histogram lets you check exposure conditions as you record images (page 34). You can also display the histogram of a recorded image in the PLAY mode.

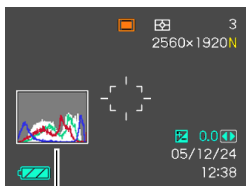

Histogram

- A histogram is a graph that represents the lightness of an image in terms of the number of pixels. The vertical axis indicates the number of pixels, while the horizontal axis indicates lightness. You can use the histogram to determine whether an image includes the shadowing (left side), mid tones (center), and highlighting (right) required to bring out sufficient image detail. If the histogram appears too lopsided for some reason, you can use EV shift (exposure compensation) to move it left or right in order to achieve better balance. Optimum exposure can be achieved by correcting exposure so the graph is as close to the center as possible.

- An RGB histogram that shows the distribution of R (red), G (green), and B (blue) components is also displayed. This histogram can be used to determine whether there is too much or too little of each of the color components in an image.

NOTE

- You can use key customization (page 125) to configure the camera to perform exposure compensation whenever you press [◀] or [▶] while in a REC mode. If you do this, you can adjust exposure compensation while viewing the on-screen histogram (page 88).
- When the histogram is too far to the left, it means that there are too many dark pixels. This type of histogram results when the overall image is dark. A histogram that is too far to the left may result in “black out” of the dark areas of an image.

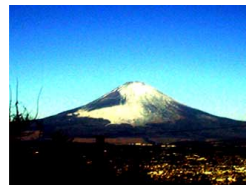

OTHER RECORDING FUNCTIONS

- When the histogram is too far to the right, it means that there are too many light pixels.

This type of histogram results when the overall image is light. A histogram that is too far to the right may result in “white out” of the light areas of an image.

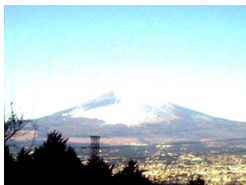

- A centered histogram indicates that there is good distribution of light pixels and dark pixels. This type of histogram results when the overall image is at optimal lightness.

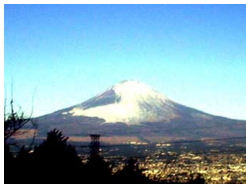

▶▶ IMPORTANT! ◀◀

- Note that the above histograms are shown for illustrative purposes only. You may not be able to achieve exactly the same shapes for particular subjects.
- A centered histogram does not necessarily guarantee optimum exposure. The recorded image may be over-exposed or under-exposed, even though its histogram is centered.
- You may not be able to achieve an optimum histogram configuration due to the limitations of EV shift.
- Use of the flash as well as certain shooting conditions can cause the histogram to indicate exposure that is different from the actual exposure of the image when it was recorded.
- The RGB (color component) histogram is displayed for snapshots only. In the following modes, only the luminance distribution histogram appears on the monitor screen.
Movie Mode, Past Movie Mode, Short Movie Mode, MOVIE BEST SHOT Mode

REC Mode Camera Settings

The following are the settings you can configure before recording an image using a REC mode.

- ISO sensitivity
- Metering
- Color filtering
- Sharpness
- Saturation
- Contrast
- Grid on/off
- Image Review on/off
- Icon Help on/off
- L/R key setting
- Power on default settings
- Resetting the camera

NOTE

- You can also configure the settings listed below. See the referenced pages for more information.
 - Size (page 77)
 - Quality (Snapshots) (page 79)
 - Quality (Movies) (page 105)
 - White Balance (page 91)
 - Digital Zoom (page 68)
 - AF Area (page 82)
 - Audio Snap (page 114)
 - Flash Intensity (page 72)
 - Flash Assist (page 73)

Specifying ISO Sensitivity

You can change the ISO sensitivity setting for better images in places where lighting is dim or when you are using faster shutter speeds.

- ISO sensitivity is expressed in terms of values that originally indicated the sensitivity to light for photographic film. A larger value indicates higher sensitivity, which is better for recording when available lighting is dim.

1. In a REC mode, press [MENU].
2. Select the “REC” tab, select “ISO”, and then press [▶].
3. Use [▲] and [▼] to select the setting you want and then press [SET].

To get this:	Select this setting:
Automatic sensitivity selection	Auto
Lower sensitivity	ISO 50
↑	ISO 100
↓	ISO 200
Higher sensitivity	ISO 400

▶▶ IMPORTANT! ◀◀

- Under certain conditions, a high shutter speed in combination with a high ISO sensitivity setting can cause digital noise (graininess), which makes an image appear rough. For clean, good-quality images, use the lowest ISO sensitivity setting possible.
- Using a high ISO sensitivity setting along with the flash to shoot a nearby subject may result in improper illumination of the subject.

▶▶ NOTE ◀◀

- You can use the key customization feature (page 125) to configure the camera so the ISO sensitivity setting changes whenever you press [◀] and [▶] while in a REC mode.

Selecting the Metering Mode

The metering mode determines what part of the subject is metered for exposure. You can use the following procedure to change the camera's metering mode.

1. In a REC mode, press [MENU].
2. Select the "REC" tab, select "Metering", and then press [▶].
3. Use [▲] and [▼] to select the setting you want, and then press [SET].

Multi (Multi pattern)

Multi (Multi pattern) metering divides the image into sections and measures the light in each section for a balanced exposure reading. The camera automatically determines shooting conditions according to the measured lighting pattern, and makes exposure settings accordingly. This type of metering provides error-free exposure settings for a wide range of shooting conditions.



Center Weighted

Center weighted metering measures light concentrating on the center of the focus area. Use this metering method when you want to exert some control over exposure, without leaving settings totally up to the camera.



Spot

Spot metering takes readings at a very small area. Use this metering method when you want exposure to be set according to the brightness of a particular subject, without it being affected by surrounding conditions.



▶▶ IMPORTANT! ◀◀

- When "Multi" is selected as the metering mode, certain procedures cause the metering mode setting to change automatically as described below.
- Changing the exposure compensation setting (page 88) to a value other than 0.0 changes the metering mode setting to "Center Weighted." The metering mode changes back to "Multi" when you return the exposure compensation setting to 0.0.

Using the Filter Function

The camera's filter function lets you alter the tint of an image when you record it.

1. In a REC mode, press [MENU].
2. Select the "REC" tab, select "Filter", and then press [▶].
3. Use [▲] and [▼] to select the setting you want, and then press [SET].
 - Available filter settings are: Off, B/W, Sepia, Red, Green, Blue, Yellow, Pink, Purple

▶▶ IMPORTANT! ◀◀

- Using the camera's filter feature produces the same effect as attaching a color filter to the lens.

Specifying Outline Sharpness

Use the following procedure to control the sharpness of image outlines.

1. In a REC mode, press [MENU].
2. Select the "REC" tab, select "Sharpness", and then press [▶].
3. Use [▲] and [▼] to select the setting you want, and then press [SET].

To get this:	Select this setting:
High sharpness	+2
↑	+1
Normal sharpness	0
↓	-1
Low sharpness	-2

Specifying Color Saturation

Use the following procedure to control the intensity of the image you are recording.

1. In a REC mode, press [MENU].
2. Select the “REC” tab, select “Saturation”, and then press [▶].
3. Use [▲] and [▼] to select the setting you want, and then press [SET].

To get this:	Select this setting:
High color saturation (intensity)	+2
↑	+1
Normal color saturation (intensity)	0
↓	-1
Low color saturation (intensity)	-2

Specifying Contrast

Use this procedure to adjust the relative difference between the light areas and dark areas of the image you are recording.

1. In a REC mode, press [MENU].
2. Select the “REC” tab, select “Contrast”, and then press [▶].
3. Use [▲] and [▼] to select the setting you want, and then press [SET].

To get this:	Select this setting:
High contrast	+2
↑	+1
Normal contrast	0
↓	-1
Low contrast	-2

Turning the On-screen Grid On and Off

You can display gridlines on the monitor screen to help you compose images and ensure that the camera is straight when recording.

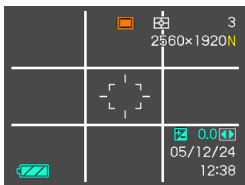

1. In a REC mode, press [MENU].
2. Select the “REC” tab, select “Grid”, and then press [▶].
3. Use [▲] and [▼] to select the setting you want, and then press [SET].

To do this:	Select this setting:
Display the grid	On
Hide the grid	Off

Turning Image Review On and Off

Image review displays the images you record on the monitor screen as soon as you record them. Use the following procedure to turn image review on and off.

1. In a REC mode, press [MENU].
2. Select the “REC” tab, select “Review”, and then press [▶].
3. Use [▲] and [▼] to select the setting you want, and then press [SET].

To do this:	Select this setting:
Display images on the monitor screen for about one second immediately after they are recorded	On
Do not display images immediately after they are recorded	Off

Using Icon Help

Icon Help displays guidance text about an icon when you select it on the monitor screen while in a REC mode (page 29).

- Icon Help text is displayed for the following functions: current recording mode, flash mode, focus mode, white balance, self-timer, metering mode.
Note, however, that white balance, self-timer, and metering icon help text appears only when “White Balance”, “Self-timer”, or “Metering” is assigned to the [◀] and [▶] keys with the key customization feature (page 125).

1. In a REC mode, press [MENU].
2. Select the “REC” tab, select “Icon Help”, and then press [▶].
3. Use [▲] and [▼] to select the setting you want, and then press [SET].

To do this:	Select this setting:
Display guidance text when you select an icon on the monitor screen.	On
Turn off Icon Help	Off

▶▶ IMPORTANT! ◀◀

- Selecting one of the following settings causes the icon and its Icon Help text to appear momentarily on the monitor screen. The icon and text disappear after a short while.
 - Flash mode “**FA** Auto Flash” icon (page 69)
 - Focus mode “**AF** Auto Focus” icon (page 81)
 - White balance “**AWB** Auto WB” icon (page 91)

Assigning Functions to the [◀] and [▶] Keys

A “key customization” feature lets you configure the [◀] and [▶] keys so they change camera settings whenever they are pressed in a REC mode. After you configure the [◀] and [▶] keys, you can change the setting assigned to them without going through the menu screen.

- 1. In a REC mode, press [MENU].**
- 2. Select the “REC” tab, select “L/R Key”, and then press [▶].**
- 3. Use [▲] and [▼] to select the setting you want, and then press [SET].**
 - After you assign a function, you can change its setting simply by pressing the [◀] and [▶] keys.
 - EV Shift (page 88)
 - White Balance (page 91)
 - ISO (page 119)
 - Metering (page 120)
 - Self-timer (page 75)
 - Off: No function assigned

Specifying Power On Default Settings

The camera’s “mode memory” feature lets you specify the power on default settings individually for the recording mode, flash mode, focus mode, white balance mode, ISO sensitivity, AF Area, self-timer, flash intensity, digital zoom mode, manual focus position and zoom position. Turning on mode memory for a mode tells the camera to remember the status of that mode when you turn off the camera, and restore it the next time you turn the camera back on. When mode memory is turned off, the camera automatically restores the initial factory default setting for the applicable mode.

— The following table shows what happens when you turn mode memory on or off for each mode.

OTHER RECORDING FUNCTIONS

Function	On	Off
Flash	Setting when camera is turned off	Auto
Focus		Auto
White Balance		Auto
ISO		Auto
AF Area		Spot
Metering		Multi
Self-timer		Off
Flash Intensity		0
Digital Zoom		On
MF Position		Last Auto Focus position that was in effect before you switched to manual focus
Zoom Position*		Wide

* Only the optical zoom position is remembered.

1. In a REC mode, press [MENU].
2. Use [◀] and [▶] to select the “Memory” tab.
3. Use [▲] and [▼] to select the item you want to change, and then press [▶].
4. Use [▲] and [▼] to select the setting you want, and then press [SET].

To do this:	Select this setting:
Turn on mode memory so settings are restored at power on	On
Turn off mode memory so settings are initialized at power on	Off

▶▶ IMPORTANT! ◀◀

- Note that BEST SHOT mode settings take priority over mode memory settings. If you turn the camera off while in the BEST SHOT mode, all settings except for “REC Mode” and “Zoom Position” will be configured according to the BEST SHOT sample scene when you turn it back on again, regardless of mode memory on/off settings.
- In the following modes, “” (Flash Off) is always selected as the flash mode regardless of mode memory on/off setting.
Movie Mode, Past Movie Mode, Short Movie Mode, MOVIE BEST SHOT Mode

Resetting the Camera

Use the following procedure to reset all of the camera’s settings to their initial defaults as shown under “Menu Reference” on page 219.

- 1. Press [MENU].**
- 2. Select the “Set Up” tab, select “Reset”, and then press [▶].**
- 3. Use [▲] and [▼] to select “Reset”, and then press [SET].**
 - To cancel the procedure without resetting, select “Cancel” and press [SET].

Using the Shortcut Menu (EX Menu)

Pressing [EX] displays a shortcut menu that you can use to configure white balance, ISO sensitivity, metering, and AF area settings.

1. In a REC mode, press [EX].



2. Use [◀] and [▶] to select the item you want, and then use [▲] and [▼] to scroll through the available settings.

- Refer to the following pages for details about each of the settings.
 - Adjusting the White Balance (page 91)
 - Specifying ISO Sensitivity (page 119)
 - Specifying the Metering Mode (page 120)
 - Specifying the Auto Focus Area (page 82)

3. After configuring the settings you want, press [SET] to exit the shortcut menu.

Installing the Lens Hood and a Lens Filter

Your camera comes with a lens hood that you can install on the lens when you need it. Use of the lens hood shuts out unwanted light when shooting in very strong sunlight or against backlighting, which helps to reduce the chance of ghosting and flaring.

You can also attach commercially available 43mm filters to the lens of the camera.

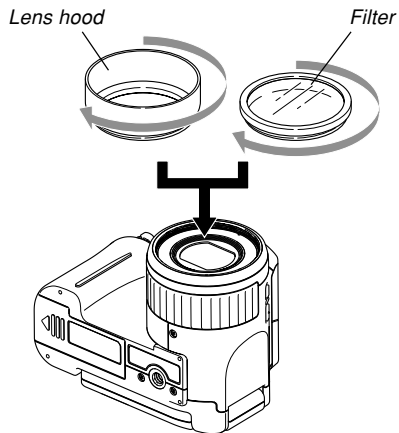

►► IMPORTANT! ◀◀

- The effectiveness of the lens hood depends on the angle of the light and other conditions.
- Using the flash with the lens hood attached can cause vignetting (darkening of the corners of the image). Remove the lens hood before using the flash.
- Carefully read the user documentation that comes with filters for information about how to use them properly.
- Keep the following points in mind when purchasing a filter.
 - Use of a filter can cause blackening around the edges of images.
 - Use of a filter may interfere with proper operation of Auto Focus and flash.
 - Filters may not deliver the same results as those obtained with a film camera.
- Do not use multiple filters.
- Use of a commercially available lens hood may cause blackening around the edges of images.

PLAYBACK

You can use the camera's built-in monitor screen to view images after you record them.

Basic Playback Operation

Use the following procedure to scroll through files stored in the camera's memory.

1. Open the monitor screen or press the power button to turn on the camera.

- This causes an image or a message to appear on the monitor screen.

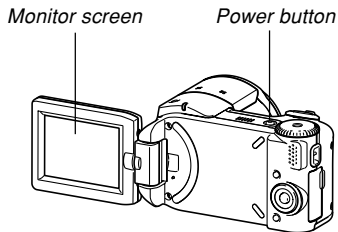

2. Align the mode dial with "▶" (PLAY mode).

- This enters the PLAY mode.

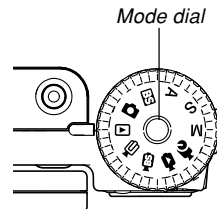

PLAY mode file type Folder name/ File name

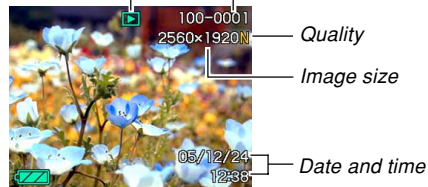

3. Use [▶] (forward) or [◀] (back) to scroll through files on the monitor screen.



▶▶ NOTE ◀◀

- Holding down [◀] or [▶] scrolls images at high speed.
- In order to allow for faster playback image scrolling, the image that initially appears on the monitor screen is a preview image, which is of somewhat lower quality than the actual display image. The actual display image appears a short while after the preview image. This does not apply to images copied from another digital camera.

Playing an Audio Snapshot

Perform the steps below to display an audio snapshot (indicated by ) and play its audio.

1. In the PLAY mode, use [◀] and [▶] until the image you want is displayed.

2. Press [SET].

- This plays back the audio that accompanies the displayed image.
- You can perform the following operations while audio is playing.

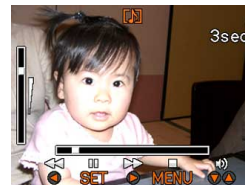

To do this:	Do this:
Fast forward or fast reverse the audio	Hold down [◀] or [▶].
Pause and unpause audio playback	Press [SET].
Adjust audio volume	Press [▲] or [▼].
Cancel playback	Press [MENU].

▶▶ IMPORTANT! ◀◀

- Audio volume can be adjusted only when playback is being performed or is paused.

Zooming the Display Image

Perform the following procedure to zoom the image currently on the monitor screen up to eight times its normal size.

1. In the PLAY mode, use [◀] and [▶] to display the image you want.

2. Shift the zoom controller towards .

- This zooms the images.
- A graphic indicator appears in the lower right corner, indicating the area of the original image that is zoomed on the monitor screen.
- You can toggle display of the zoom factor on and off by pressing [DISP].

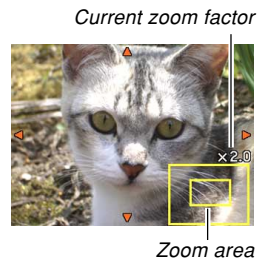

3. Use [▲], [▼], [◀], and [▶] to shift the image up, down, left, or right.

4. Press [MENU] to return the image to its original size.

▶▶ IMPORTANT! ◀◀

- Depending on the original size of the recorded image, you may not be able to zoom a display image the full eight times normal size.

Resizing an Image

You can resize a recorded image to either of the three following sizes.

- 1600 × 1200 pixels (UXGA): Best for print sizes 3.5" × 5" or smaller (More detail than 1280 × 960)
- 1280 × 960 pixels (SXGA): Best for print sizes 3.5" × 5" or smaller
- 640 × 480 pixels (VGA): Best for attachment to e-mail messages or incorporation into Web pages

1. In the PLAY mode, press [MENU].

2. Select the "PLAY" tab, select "Resize", and then press [▶].

- Note that this operation is possible only when a snapshot image is on the monitor screen.



3. Use [◀] and [▶] to scroll through images and display the one you want to resize.

4. Use [▲] and [▼] to select the setting you want, and then press [SET].

- To cancel the resize operation, select “Cancel”.

▶▶ IMPORTANT! ◀◀

- Resizing an image creates a new file that contains the image in the size you select. The file with the original image also remains in memory.
- Note that you cannot resize the following types of images.
 - 640 × 480 pixel and smaller images
 - 2560 × 1712 pixel (3:2) images
 - Movie images
 - Images created with MOTION PRINT
 - Images recorded with another camera
- The resize operation cannot be performed when there is not enough memory to store the resized image.
- When you display a resized image on the camera’s monitor screen, the date and time that appear when the image is displayed indicate when the image was originally recorded, not when the image was resized.

Cropping an Image

You can use the following procedure to crop a portion of an enlarged image.

1. In the **PLAY** mode, use [**◀**] and [**▶**] to scroll through images and display the one you want to crop.
2. Press [**MENU**].
3. Select the “**PLAY**” tab, select “**Trimming**”, and then press [**▶**].
 - This causes a cropping boundary to appear.
 - Note that this operation is possible only when a snapshot image is on the monitor screen.
4. Use the zoom controller to make the cropping boundary larger or smaller.
 - The smaller the image, the more limited is the size of the cropping boundary.

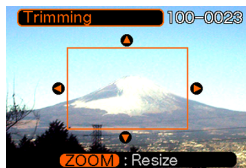

5. Use [**▲**], [**▼**], [**◀**], and [**▶**] to move the cropping boundary up, down, left, or right until the area of the image you want to extract is within the boundary.
6. Press [**SET**] to extract the part of the image enclosed in the cropping boundary.
 - If you want to cancel the procedure at any point, press [**MENU**].

▶▶ IMPORTANT! ◀◀

- Cropping an image creates a new file that contains the cropped image. The file with the original image also remains in memory.
- Note that you cannot crop the following types of images.
 - 2560 × 1712 pixel (3:2) images
 - Movie images
 - Images created with MOTION PRINT
 - Images recorded with another camera
- The cropping operation cannot be performed when there is not enough memory to store the cropped image.
- When you display a cropped image on the camera's monitor screen, the date and time that appear when the image is displayed indicate when the image was originally recorded, not when the image was cropped.

Playing and Editing a Movie**Playing a Movie**

Use the following procedure to play a movie you recorded with this camera.

- 1. In the PLAY mode, use [◀] and [▶] to scroll through movies on the monitor screen and display the one you want.**

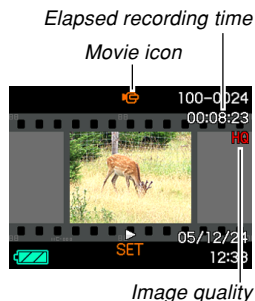

- 2. Press [SET].**

- This starts playback of the movie.
- You can perform the following operations while a movie is playing.

PLAYBACK

To do this:	Do this:
Fast forward or fast reverse playback • Each press increases the speed one more step.	Press [◀] or [▶].
Return fast forward or fast reverse movie playback to normal speed	Press [SET].
Pause movie playback	Press [SET].
Scroll paused playback one frame	Press [◀] or [▶].
Stop movie playback	Press [MENU].
Adjust the movie audio volume level	Press [▲] or [▼].
Toggle monitor screen indicators on and off	Press [DISP].
Zoom the movie image	Move the zoom controller towards  .
Scroll a zoomed movie image on the monitor screen	Use [▲], [▼], [◀], [▶].

▶▶ IMPORTANT! ◀◀

- You can adjust the volume level of movie audio during movie playback only.

Editing a Movie

Use the procedure in this section to edit and delete movies. Editing operations let you cut everything before or after a specific frame, or to cut everything between two frames.

»» IMPORTANT! ««

- Cut operations cannot be undone. Make sure you really want to cut the part of the movie you are specifying before executing the cut operation.
- A movie that is shorter than five seconds cannot be edited.
- Splicing of two different movies into a single movie or cutting one movie into multiple parts are not supported by camera operations. However, you can splice movies and cut movies into multiple parts on your computer using the bundled Ulead Movie Wizard SE VCD application.

■ To cut everything before or after a specific frame

1. While the movie you are editing is playing, press [SET].

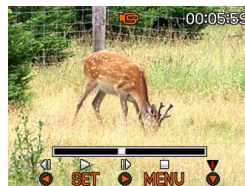

- This will pause movie playback.



2. Press [▼].

- You can also display the same screen while in the PLAY mode, by pressing [MENU], selecting the “PLAY” tab, selecting “Movie Editing”, and then pressing [▶].

3. Use [▲] and [▼] to select the operation you want to perform.

To do this:	Select this setting:
Cut everything before a specific frame	 Cut
Cut everything after a specific frame	 Cut
Exit the cut mode	Cancel

4. Display the frame where you want the cut to be located.

To do this:	Do this:
Fast forward or fast reverse playback	Press [◀] or [▶].
Pause or unpause movie playback	Press [SET].
Scroll paused playback one frame	Press [◀] or [▶].
Cancel the cut operation	Press [MENU].
Adjust the movie audio volume level	Press [▲] or [▼].

- The red portion of the indicator bar shows what part will be cut.

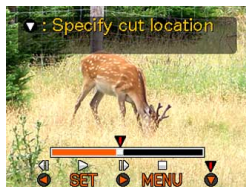

5. When the frame you want is displayed, press [▼].

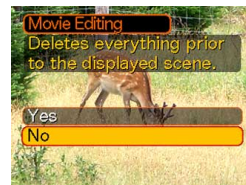

6. Use [▲] and [▼] to select “Yes,” and then press [SET].

- The message “Busy.... Please wait...” will remain on the display as the cut operation is performed. Cutting is complete when the message disappears.
- Select “No” to exit the cut mode.

■ To cut everything between two specific frames

1. While the movie is playing, press [SET].

- This will pause movie playback.

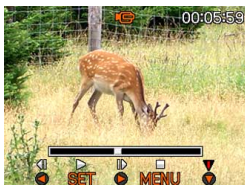

2. Press [▼].

- You can also display the same screen while in the PLAY mode, by pressing [MENU], selecting the “PLAY” tab, selecting “Movie Editing”, and then pressing [▶].

3. Use [▲] and [▼] to select “Cut”, and then press [SET].

- Select “Cancel” to exit the cut mode.

4. Display the starting frame where you want the first cut to be located.

To do this:	Do this:
Fast forward or fast reverse playback	Press [◀] or [▶].
Pause or unpause movie playback	Press [SET].
Scroll paused playback one frame	Press [◀] or [▶].
Cancel the cut operation	Press [MENU].
Adjust the movie audio volume level	Press [▲] or [▼].

5. When the frame you want is displayed, press [▼].

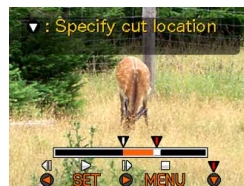

6. Repeat step 4 to display the ending frame where you want the second cut to be located.

- The red portion of the indicator bar shows what part will be cut.

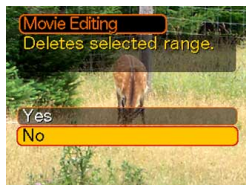

7. Use [▲] and [▼] to select “Yes”, and then press [SET].

- The message “Busy.... Please wait...” will remain on the display as the cut operation is performed. Cutting is complete when the message disappears.
- Select “No” to exit the cut mode.

Capturing a Still Image from a Movie (MOTION PRINT)

The MOTION PRINT feature lets you capture a frame from an existing movie and create a still image that is suitable for printing. There are two layouts you can use when capturing an image, and the layout you select determines the final image size.

- 9 frames (1600 × 1200-pixel final image size)

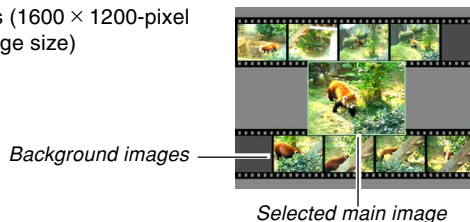

- 1 frame (640 × 480-pixel final data size)

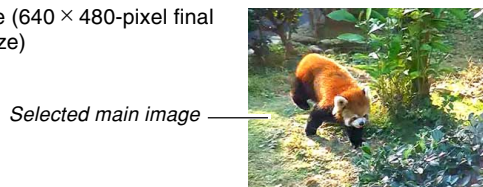

■ To capture a still image from a movie

1. In the **PLAY** mode, use [**◀**] and [**▶**] to scroll through movies on the monitor screen and display the one that contains the frames you want.

2. Press [**MENU**].

3. Select the “**PLAY**” tab, select “**MOTION PRINT**”, and then press [**▶**].

4. Use [**▲**] and [**▼**] to select the layout (“**1 frame**” or “**9 frames**”) you want to use.

- Select “Cancel” to exit the **MOTION PRINT** mode.



5. Use [**◀**] and [**▶**] to display the frame that you want to use as the main image.

- Holding down either button scrolls at high speed.

6. After selecting the frame you want, press [**SET**].

- This displays the resulting still image.
- If you selected “9 frames” for the layout, the frame you selected in step 4 will be the main image, and the frames on either side of it will be used as the background frames.
- If you selected “1 frame” in step 4, an image of the frame you selected in step 6 appears here.



Displaying the 9-image View

The following procedure displays nine images on the monitor screen at the same time.

1. In the PLAY mode, shift the zoom controller towards .

- This displays the 9-image screen with the image that was on the monitor screen in step 2 in the center, with a selection boundary around it.
- If there are fewer than nine images in memory, they are displayed starting from the upper left corner. The selection boundary is located at the image that was on the display before you switched to the 9-image view.

- ### 2. Use [▲], [▼], [◀], and [▶] to move the selection boundary to the image you want. Pressing [▶] while the selection boundary is in the right column or [◀] while it is in the left column scrolls to the next full screen of nine images.

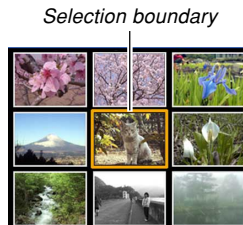

Example: When there are 20 images in memory, and Image 1 is displayed first

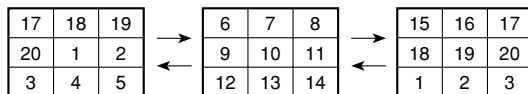

- ### 3. Pressing any button besides [▲], [▼], [◀], or [▶] displays the full-size version of the image where the selection boundary is located.



Playing a Slideshow

A slideshow automatically plays back images in sequence at a fixed interval.



1. In the **PLAY** mode, press **[MENU]**.
2. Select the “**PLAY**” tab, select “**Slideshow**”, and then press **[▶]**.

3. Use the screen that appears to configure the image, time, and interval settings.

Images	<ul style="list-style-type: none"> • All Images Displays all images in camera memory. •  Only This icon appears only in the case of snapshots and audio snapshots. •  Only This icon appears only in the case of movies. • One Image Displays a particular image.
Time	Use [◀] and [▶] to specify the playback time you want (1 to 5 minutes, or 10, 15, 30, or 60 minutes).
Interval	<p>Use [◀] and [▶] to specify the interval you want (MAX, or 1 to 30 seconds).</p> <ul style="list-style-type: none"> • When playback reaches a movie file while “MAX” is selected as the interval, only the first frame of the movie is displayed.

4. Use [▲] and [▼] to select “Start”, and then press [SET].

- This starts the slideshow.

5. To stop the slideshow, press [SET].

- The slideshow will also stop automatically after the amount of time you specified for “Time” elapses.

▶▶ IMPORTANT! ◀◀

- Note that all buttons are disabled while an image change is in progress. Wait until an image is stopped on the monitor screen before performing a button operation, or hold down the button until the image stops.
- Pressing [◀] during a slideshow will scroll to the previous image, while [▶] scrolls to the next image.
- When the slideshow comes to a movie file, it plays the movie and its audio once.
- When the slideshow comes to an audio snapshot, it plays the audio once.
- The audio of movies and audio snapshots is not played when “MAX” is specified for the slideshow “Interval” setting. With all other “Interval” settings, movies and all audio (movies, audio snapshots) are played back, regardless of their length.
- While audio is playing, you can use [▲] and [▼] to adjust the volume level.
- Images copied from another digital camera or a computer may take longer time to appear than the slideshow interval time you specify.
- If there are indicators on the display, you can clear them by pressing [DISP] (page 34).

- When the slideshow reaches a movie while “One Image” is selected for “Images”, the movie will repeat playback for the time specified by for “Time”.

Rotating the Display Image

Use the following procedure to rotate the image 90 degrees and register the rotation information along with the image. After you do this, the image is always displayed in its rotated orientation.

- 1. In the PLAY mode, press [MENU].**
- 2. Select the “PLAY” tab, select “Rotation”, and then press [▶].**
 - Note that this operation is possible only when a snapshot image is on the monitor screen.
- 3. Use [◀] and [▶] to scroll through images until the one you want to rotate is on the monitor screen.**

4. Use [▲] and [▼] to select “Rotate”, and then press [SET].

- Each press of [SET] rotates the image 90 degrees.

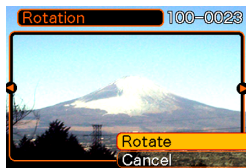

5. After you are finished configuring settings, press [MENU] to exit the setting screen.

»» IMPORTANT! ««

- You cannot rotate an image that is protected. To rotate such an image, first unprotect it.
- You may not be able to rotate a digital image that was recorded with another type of digital camera.
- You cannot rotate the following types of images.
 - Movie images
 - Images created with MOTION PRINT
- Image rotation is supported for single image only. You cannot rotate a 9-image screen.

Adding Audio to a Snapshot

The “after-recording” feature lets you add audio to snapshots after they are recorded. You can also re-record the audio of an audio snapshot (one with a  icon on it).

- **Audio Format:** WAVE/ADPCM recording format
This is the Windows standard format for audio recording. The file extension of a WAVE/ADPCM file is “.WAV”.
- **Recording Time:**
Up to about 30 seconds per image
- **Audio File Size:**
Approximately 120KB (30-second recording of approximately 4KB per second)

1. In the PLAY mode, use [◀] and [▶] to scroll through snapshots until the one to which you want to add audio is displayed.
2. Press [MENU].
3. Select the “PLAY” tab, select “Dubbing”, and then press [▶].



4. Press the shutter button to start audio recording.
5. Recording stops after about 30 seconds or when you press the shutter button.

To re-record audio

1. In the PLAY mode, use [◀] and [▶] to scroll through snapshots until the one whose audio you want to re-record is displayed.
2. Press [MENU].
3. Select the “PLAY” tab, select “Dubbing”, and then press [▶].
4. Use [▲] and [▼] to select “Delete”, and then press [SET].
 - If you merely want to delete the audio without re-recording, press [MENU] here to complete the procedure.
5. Press the shutter button to start audio recording.
6. Recording stops after about 30 seconds or when you press the shutter button.
 - This deletes the existing audio and replaces it with the new one.

▶▶ IMPORTANT! ◀◀

- Take care that you do not block the stereo microphones with your fingers.
- Good recording results are not possible when the camera is too far from the subject.

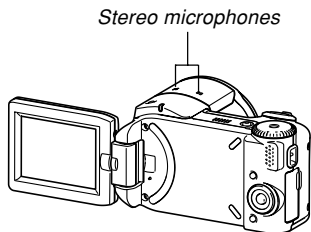

- The  (Audio) icon appears on the monitor screen after audio recording is complete.
- You will not be able to record audio when remaining memory capacity is low.
- You cannot add audio to the following types of images.
 - Movie images
 - Images created with MOTION PRINT
 - Protected snapshot (page 155)
- Audio that is re-recorded or deleted cannot be recovered. Make sure you no longer need audio before re-recording or deleting it.

Displaying Camera Images on a TV Screen

You can display recorded images on a TV screen and even use a TV screen to compose images before you record them. To display camera images on a TV, you need a television equipped with a video input terminal, and the AV cable that comes with the camera.

1. Connect one end of the AV cable that comes with the camera to the camera's [USB/AV] port, and the other end to the video input terminal of the TV.

- Connect the yellow plug of the AV cable to the yellow video jack of the TV. Connect the white plug (left channel) to the white audio jack and the red plug (right channel) to the red audio jack of the TV.
- When connecting the USB cable to the camera, make sure the ▲ symbol on the camera's [USB/AV] port is aligned with the ▲ symbol on the USB cable plug.

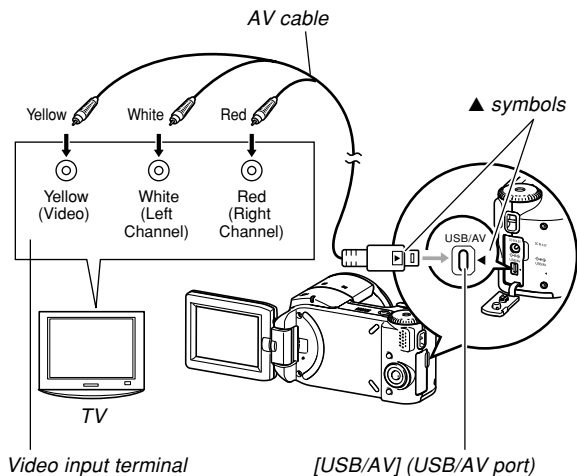

▶▶ IMPORTANT! ◀◀

- All icons and indicators that appear on the monitor screen also appear on the TV screen.
- Stereo output is possible if you connect to a TV that supports stereo input.
- Depending on the size of the TV screen, recorded images and images during recording may not fill the entire screen.
- For video output, the audio volume level is initially set to maximum. Perform volume level adjustment using TV controls.

2. Turn on the TV and select its video input mode.
3. Now when you perform normal image playback and recording operations on the camera, the applicable image appears on the TV screen.

Selecting the Video Input System

You can select either NTSC or PAL for the video output system to match the system of the TV you are using.

- 1. In a REC mode or the PLAY mode, press [MENU].**
- 2. Select the “Set Up” tab, select “Video Out”, and then press [▶].**
- 3. Use [▲] and [▼] to select the setting you want, and then press [SET].**

If you are using a TV designed for use in this area:	Select this setting:
U.S., Japan, and other areas that use the NTSC system	NTSC
Europe and other areas that use the PAL system	PAL

▶▶ IMPORTANT! ◀◀

- Images will not display properly if you select the wrong video input system.
- This camera supports the NTSC and PAL video input systems only. Images will not display properly if you use a TV (monitor) that is designed for a different video input system.

DELETING FILES

You can delete a single file, or you can delete all files currently in memory.

▶▶ IMPORTANT! ◀◀

- Note that file deletion cannot be undone. Once you delete a file, it is gone. Make sure you really do not need a file anymore before you delete it. Especially when deleting all files, make sure you check all the files you have stored before proceeding.
- A protected file cannot be deleted. To delete a protected file, unprotect it first (page 155).
- Delete cannot be performed when all files in memory are protected (page 156).
- Deleting an audio snapshot deletes both the image file and the audio file attached to it.

Deleting a Single File

1. In the **PLAY** mode, press [▼] (🗑️).

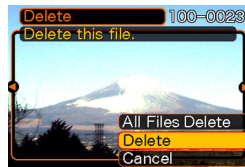

2. Use [◀] and [▶] to scroll through files and display the one you want to delete.
3. Use [▲] and [▼] to select “Delete”.
 - To exit the file delete operation without deleting anything, select “Cancel”.
4. Press [SET] to delete the file.
 - Repeat steps 2 through 4 to delete other files, if you want.
5. Press [MENU] to exit the menu screen.

Deleting All Files

1. In the **PLAY** mode, press [▼] (🗑️).
2. Use [▲] and [▼] to select “All Files Delete”, and then press [SET].
3. Use [▲] and [▼] to select “Yes”.
 - To exit the file delete operation without deleting anything, select “No”.
4. Press [SET] to delete all the files.
 - The message “There are no files.” appears on the screen after all of the files are deleted.

FILE MANAGEMENT

The file management capabilities of the camera make it easy to keep track of images. You can protect files against deletion and store the files you want in the camera's built-in memory.

Folders

Your camera automatically creates folders in its built-in flash memory or on the memory card.

Memory Folders and Files

An image you record is automatically stored in a folder, whose name is a serial number. You can have up to 900 folders in memory at the same time. Folder names are generated as shown below.

Example: Name of the 100th folder.

100CASIO

Serial number (3 digits)

Each folder can hold files numbered up to 9,999. Trying to store the 10,000th file in a folder causes the next serially numbered folder to be created. File names are generated as shown below.

Example: Name of the 26th file

CIMG0026.JPG

Extension

Serial number (4 digits)

- The folder and file names described here appear when you view folders and files on a computer. See page 33 for information about how the camera displays folder and file names.
- The actual number of files you will be able to store on a memory card depends on image size and quality, card capacity, etc.
- For details about the folder structure, see "Memory Folder Structure" on page 197.

Protecting Files

Once you protect a file it cannot be deleted (page 152). You can protect files individually or you can protect all files in memory with a single operation.

To protect a single file

1. In the **PLAY** mode, press **[MENU]**.
2. Select the “**PLAY**” tab, select “**Protect**”, and then press **[▶]**.
 
3. Use **[◀]** and **[▶]** to scroll through files and display the one you want to protect.

4. Use **[▲]** and **[▼]** to select “**On**”, and then press **[SET]**.

- A file that is protected is indicated by the  mark.
- To unprotect a file, select “**Off**” in step 4, and then press **[SET]**.

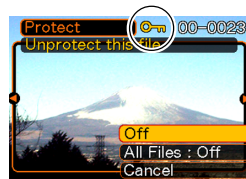

5. Press **[MENU]** to exit the menu screen.

To protect all files in memory

1. In the PLAY mode, press [MENU].
2. Select the “PLAY” tab, select “Protect”, and then press [▶].
3. Use [▲] and [▼] to select “All Files : On”, and then press [SET].
 - To unprotect all files, press [SET] in step 3 so the setting shows “All Files : Off”.
4. Press [MENU] to exit the menu screen.

OTHER SETTINGS

Configuring Sound Settings

You can configure different sounds to play whenever you turn on the camera, press the shutter button half-way or all the way, or perform a key operation.

To configure sound settings

1. Press [MENU].
2. Select the “Set Up” tab, select “Sounds”, and then press [▶].
3. Use [▲] and [▼] to select the sound whose setting you want to configure, and then press [▶].

4. Use [▲] and [▼] to change the setting, and then press [SET].

To do this:	Select this setting:
Select a built-in sound	Sound 1 through Sound 5
Turn off the sound	Off

To set the confirmation tone volume level

1. Press [MENU].
2. Select the “Set Up” tab, select “Sounds”, and then press [▶].
3. Use [▲] and [▼] to select “ Operation”.
4. Use [◀] and [▶] to specify the volume setting you want, and then press [SET].
 - You can set the volume in the range of 0 (no sound) to 7 (loudest).

▶▶ IMPORTANT! ◀◀

- The volume setting you make here also affects the video output volume level (page 149).

To set the audio volume level for movie and audio snapshot playback

1. Press [MENU].
2. Select the “Set Up” tab, select “Sounds”, and then press [▶].
3. Use [▲] and [▼] to select “ Play”.
4. Use [◀] and [▶] to specify the playback volume setting you want, and then press [SET].
 - You can set the playback volume in the range of 0 (no sound) to 7 (loudest).

▶▶ IMPORTANT! ◀◀

- The volume setting you make here does not affect the video output volume level (page 149).

Specifying the File Name Serial Number Generation Method

Use the following procedure to specify the method for generating the serial number used for file names (page 154).

1. Press [MENU].
2. Select the “Set Up” tab, select “File No.,” and then press [▶].
3. Use [▲] and [▼] to change the setting, and then press [SET].

To do this for a newly saved file:	Select this setting:
Store the last file number used and increment it, regardless of whether files are deleted or whether the memory card is replaced with a new one	Continue
Find the highest file number in the current folder and increment it	Reset

Setting the Clock

Use the procedures in this section to select a Home Time Zone, and to change its date and time settings. If you want to change the time and date setting only without changing the Home Time Zone, perform the procedure under “To set the current time and date” (page 161) only.

▶▶ IMPORTANT! ◀◀

- Make sure you select your Home Time zone (the zone where you are currently located) before changing the time and date settings. Otherwise, the time and date setting will change automatically when you select another time zone.

To select your Home Time zone

1. Press [MENU].
 2. Select the “Set Up” tab, select “World Time”, and then press [▶].
 - This displays the current World Time zone.
 3. Use [▲] and [▼] to select “Home”, and then press [▶].
 4. Use [▲] and [▼] to select “City”, and then press [▶].
 5. Use [▲], [▼], [◀], and [▶] to select the geographical area that contains location you want to select as your Home Time zone, and then press [SET].
6. Use [▲] and [▼] to select the city you want, and then press [SET].
 7. After selecting the city you want, press [SET] to register its zone as your Home Time zone.

To set the current time and date

1. Press [MENU].
2. Select the “Set Up” tab, select “Adjust”, and then press [▶].
3. Set the current date and the time.

To do this:	Do this:
Change the setting at the current cursor location	Press [▲] or [▼].
Move the cursor between settings	Press [◀] or [▶].
Toggle between 12-hour and 24-hour timekeeping	Press [DISP].

4. When all the settings are the way you want, press [SET] to register them and exit the setting screen.

Changing the Date Format

You can select from among three different formats for display of the date.

1. Press [MENU].
2. Select the “Set Up” tab, select “Date Style”, and then press [▶].
3. Use [▲] and [▼] to change the setting, and then press [SET].

Example: December 24, 2005

To display the date like this:	Select this format:
05/12/24	YY/MM/DD
24/12/05	DD/MM/YY
12/24/05	MM/DD/YY

Using World Time

You can use the World Time screen to select a time zone and instantly change the time setting of the camera's clock when you go on a trip, etc. World Time lets you select one of 162 cities in 32 time zones.

To display the World Time screen

1. Press [MENU].
2. Select the "Set Up" tab, select "World Time", and then press [▶].
3. Use [▲] and [▼] to select "World".

To do this:	Select this:
Display the time in your home time zone	Home
Display the time in the zone currently selected on the World Time screen	World

4. Press [SET] to exit the setting screen.

To configure World Time settings

1. Press [MENU].
2. Select the "Set Up" tab, select "World Time", and then press [▶].
3. Use [▲] and [▼] to select "World", and then press [▶].
4. Use [▲] and [▼] to select "City", and then press [▶].



- To configure the summer time setting, select "DST", and then select either "On" or "Off".
- Summer time is used in some geographical areas to advance the current time setting by one hour during the summer months.
- Use of summer time depends on the local customs and laws.

OTHER SETTINGS

5. Use [▲], [▼], [◀], and [▶] to select the geographical area you want, and then press [SET].



6. Use [▲] and [▼] to select the city you want, and then press [SET].
7. When the setting is the way you want, press [SET] to apply it and exit the setting screen.

Changing the Display Language

You can use the following procedure to select one of ten languages as the display language.

1. Press [MENU].
2. Select the “Set Up” tab, select “Language”, and then press [▶].
3. Use [▲], [▼], [◀], and [▶] to change the setting, and then press [SET].

Changing the USB Port Protocol

You can use the procedure below to change the communication protocol of the camera's USB port when connecting to a computer, printer, or other external device. Select the protocol that suits the device to which you are connecting.

1. Press [MENU].
2. Select the "Set Up" tab, select "USB", and then press [▶].
3. Use [▲] and [▼] to select the setting you want, and then press [SET].

When connecting to this type of device:	Select this setting:
Computer	Mass Storage
PictBridge-compatible printer (page 177)	PTP (PictBridge)*

* "PTP" stands for "Picture Transfer Protocol".

- Mass Storage causes the camera to see the computer as an external storage device. Use this setting for normal transfer of images from the camera to a computer (using the bundled Photo Loader application).
- PTP (PictBridge) simplifies the transfer of image data to the connected device.

Formatting Built-in Memory

Formatting built-in memory deletes any data stored in it.

▶▶ IMPORTANT! ◀◀

- Note that data deleted by a format operation cannot be recovered. Check to make sure you do not need any of the data in memory before you format it.
- Formatting built-in memory deletes the following.
 - Protected images
 - BEST SHOT mode user setups
 - MOVIE BEST SHOT mode user setups

1. Check to make sure there is no memory card loaded in the camera.

- If there is a memory card loaded in the camera, remove it (page 168).

2. Press [MENU].

3. Select the “Set Up” tab, select “Format”, and then press [▶].

4. Use [▲] and [▼] to select “Format”, and then press [SET]. Entering the PLAY mode after formatting built-in memory will cause the message “There are no files.” to appear.

- To exit the format operation without formatting, select “Cancel”.



USING A MEMORY CARD

You can expand the storage capabilities of your camera by using a commercially available memory card (SD memory card or MultiMediaCard). You can also copy files from built-in flash memory to a memory card and from a memory card to flash memory.



- Normally, files are stored in built-in flash memory. When you insert a memory card, however, the camera automatically stores files to the card.
- Note that you cannot save files to built-in memory while a memory card is installed in the camera.

▶▶ IMPORTANT! ◀◀

- Use only an SD memory card or a MultiMediaCard with this camera. Proper operation is not guaranteed when any other type of card is used.
- See the instructions that come with the memory card for information about how to use it.
- Certain types of cards can slow down processing speeds. If you are using a slow memory card, you may not be able to record a movie using the “HQ” image quality setting. Because of this, you should use a high-speed type SD memory card whenever possible.
- Certain types of memory cards take longer to record data, which can cause movie frames to be dropped.  and  flash on the monitor screen during recording to let you know when a frame has been dropped.
- SD memory cards have a write protect switch, which you can use to protect against accidental deletion of image data. Note, however, if you write protect an SD memory card, you must remove write protection whenever you want to record to it, format it, or delete any of its files.
- Electrostatic charge, digital noise, and other phenomena can cause data to become corrupted or even lost. Always maintain backup copies of important data on other media (CD-R, CD-RW, MO disc, computer hard disk, etc.).

Using a Memory Card

▶▶ IMPORTANT! ◀◀

- Make sure you turn off the camera before inserting or removing a memory card.
- Be sure to orient the card correctly when inserting it. Never try to force a memory card into the slot when you feel resistance.

To insert a memory card into the camera

1. Slide the battery cover in the direction indicated by the arrow, and then swing it open.

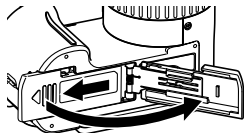

2. Positioning the memory card so its front is facing in the same direction as the camera's lens, carefully slide it into the card slot. Slide the card all the way in until you hear it click securely into place.

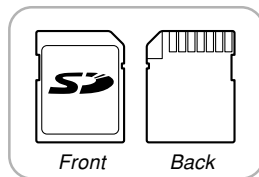
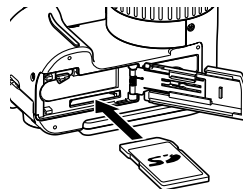

3. Swing the battery cover closed, and then slide it in the direction indicated by the arrow.

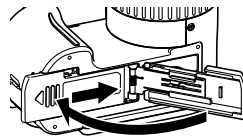

To replace the memory card

1. Press the memory card into the camera and then release it. This will cause the card to come part way out of the camera.

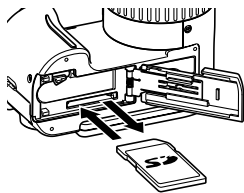

2. Pull the memory card out of the slot.

3. Load another memory card.

▶▶ IMPORTANT! ◀◀

- Never insert any other object besides a memory card into the camera's card slot. Doing so creates the risk of damage to the camera and card.
- Should water or any foreign object ever get into the card slot, immediately turn off the camera, remove the battery, and contact your dealer or nearest CASIO authorized service center.
- Never remove a card from the camera while the operation lamp is flashing green. Doing so can cause the file save operation to fail, and even damage the memory card.

Formatting a Memory Card

Formatting a memory card deletes any data already stored on it.

▶▶ IMPORTANT! ◀◀

- Be sure to use the camera to format a memory card. Formatting a memory card on a computer and then using it in the camera can slow down data processing by the camera. In the case of an SD card, formatting on a computer can result in non-conformity with the SD format, causing problems with compatibility, operation, etc.
- Note that data deleted by a memory card format operation cannot be recovered. Check to make sure you do not need any of the data on the memory card before you format it.
- Formatting a memory card that contains files deletes all the files, even those that are protected (page 155).

■ To format a memory card

1. Load the memory card into the camera.
2. Turn on the camera, and press [MENU].
3. Select the “Set Up” tab, select “Format”, and then press [▶].
4. Use [▲] and [▼] to select “Format”, and then press [SET]. Entering the PLAY mode after formatting the memory card will cause the message “There are no files.” to appear.
 - To exit the format operation without formatting, select “Cancel”.

■ Memory Card Precautions

- If a memory card starts to behave abnormally, you can restore normal operation by reformatting it. However, we recommend that you always take along more than one memory card whenever using the camera far away from the home or office.
- We recommend that you format a memory card before using it for the first time after purchasing it, or whenever the card you are using seems to be the cause of abnormal images.
- As you record data to and delete data from an SD memory card a number of times, it loses its ability to retain data. Because of this, periodic re-formatting of an SD memory card is recommended.
- Before starting a format operation, check to make sure that the battery is fully charged. Power interruption during the format operation can result in improper formatting, and even damage the memory card and make it unusable.

Copying Files

Use the procedures below to copy files between built-in memory and a memory card.

▶▶ IMPORTANT! ◀◀

- Only snapshot, movie files and audio snapshot files recorded with this camera can be copied. Other files cannot be copied.
- Copying an audio snapshot copies both its image file and the audio file.

To copy all the files in built-in memory to a memory card

1. Load the memory card into the camera.
2. Turn on the camera. Next, enter the PLAY mode and press [MENU].
3. Select the “PLAY” tab, select “Copy”, and then press [▶].



4. Use [▲] and [▼] to select “Built-in → Card”, and then press [SET].
 - This starts the copy operation and displays the message “Busy.... Please wait...”.
 - After the copy operation is complete, the monitor screen shows the last file in the folder.

To copy a specific file from a memory card to built-in memory

1. Perform steps 1 through 3 of the procedure under “To copy all the files in built-in memory to a memory card”.
2. Use [▲] and [▼] to select “Card → Built-in”, and then press [SET].
3. Use [◀] and [▶] to select the file you want to copy.
4. Use [▲] and [▼] to select “Copy”, and then press [SET].
 - This starts the copy operation and displays the message “Busy.... Please wait...”.
 - The file reappears on the monitor screen after the copy operation is complete.
 - Repeat steps 3 through 4 to copy other images, if you want.

5. Press [MENU] to exit the copy operation.

»» NOTE ««

- Files are copied to the folder in built-in memory whose name has the largest number.

PRINTING IMAGES

A digital camera provides you with a variety of different ways to print the images it records. The three main printing methods are described below. Use the method that best suits your needs.

■ Professional Print Service

The camera's DPOF feature lets you specify which images you want to print and how many copies of each you want. For more information, see "DPOF" (page 174).

»» NOTE ««

- Certain print service providers may not support DPOF or may support different printing protocols. In this case, use the protocol supported by your print service to specify the images you want to have printed.

■ Printing Directly on a Printer Equipped with a Card Slot, or a Printer that Supports PictBridge

After using the camera's DPOF feature to specify the images you want to print and how many copies of each should be printed, you can plug the memory card into a printer equipped with a card slot, or connect the camera to a PictBridge printer for printing. For more information, see "DPOF" (page 174) and "Using PictBridge" (page 177).

■ Printing with a Computer

Windows Users

The camera comes bundled with Photo Loader and Photohands applications, which can be installed on a Windows computer for image transfer, management, and printing. For more information, see “Using the Camera with a Windows Computer” (pages 183, 200).

Macintosh Users

The camera comes bundled with Photo Loader for the Macintosh, which can be installed for image transfer and management, but not for printing. Use commercially available software for printing with a Macintosh. For more information, see “Using the Camera with a Macintosh Computer” (pages 191, 215).

DPOF

The letters “DPOF” stand for “Digital Print Order Format”, which is a format for recording on a memory card or other medium which digital camera images should be printed and how many copies of the image should be printed. Then you can print on a DPOF-compatible printer or at a professional print service in accordance with the file name and number of copies settings recorded on the card.

With this camera, you can select images by viewing them on the monitor screen without needing to remember file names, their locations in memory, etc.



■ DPOF Settings

File Name,
number of copies,
date

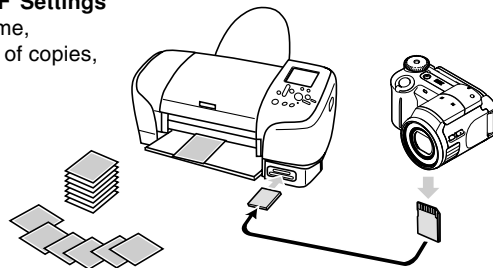

To configure print settings for a single image

1. In the **PLAY** mode, press **[MENU]**.

2. Select the “**PLAY**” tab, select “**DPOF**”, and then press **[▶]**.



3. Use **[▲]** and **[▼]** to select “**Select images**”, and then press **[▶]**.



4. Use **[◀]** and **[▶]** to display the image you want.



5. Use **[▲]** and **[▼]** to specify the number of copies.

- You can specify up to 99 for the number of copies. Specify 00 if you do not want to have the image printed.

6. To turn on date stamping for the prints, press **[DISP]** so  is displayed.

-  indicates that date stamping is turned on.
- To turn off date stamping for the prints, press **[DISP]** so  is not displayed.
- Repeat steps 4 through 6 if you want to configure other images for printing.





7. After all the settings are the way you want, press **[SET]** to apply them.

To configure print settings for all images

1. In the **PLAY** mode, press **[MENU]**.
2. Select the **“PLAY”** tab, select **“DPOF”**, and then press **[▶]**.
3. Use **[▲]** and **[▼]** to select **“All images”**, and then press **[▶]**.
4. Use **[▲]** and **[▼]** to specify the number of copies.

- You can specify up to 99 for the number of copies. Specify 00 if you do not want to have the image printed.



5. To turn on date stamping for the prints, press **[DISP]** so  is displayed.
 -  indicates that date stamping is turned on.
 - To turn off date stamping for the prints, press **[DISP]** so  is not displayed.
6. After all the settings are the way you want, press **[SET]** to apply them.

►► IMPORTANT! ◀◀

- DPOF settings are not cleared automatically after printing is complete. This means that if you perform another printing operation without clearing DPOF settings, printing will be performed in accordance with the last settings you configured. If you want to prevent this from happening, perform the procedure under “To configure print settings for all images” (page 176) and change the number of copies to “00”. After that, you can configure new DPOF settings as required.
- If you take a memory card to a professional print service, be sure to tell them that it includes DPOF settings for the images to be printed and the number of copies. If you don't, the printing service may print all images without regard to your DPOF settings, or date printing may not be performed.
- Note that some professional print services do not support DPOF printing. Check with your service before ordering prints.
- Some printers may have settings that disable date stamp and/or DPOF printing. See the user documentation that comes with your printer for details about how to enable these features.

Using PictBridge

You can connect the camera directly to a printer that supports PictBridge and perform image selection and printing using the camera monitor screen and controls. DPOF support (page 174) also lets you specify which images you want to print and how many copies of each should be printed.

- PictBridge is a standard established by the Camera and Imaging Products Association (CIPA).



PRINTING IMAGES

1. Press [MENU].
2. Select the “Set Up” tab, select “USB”, and then press [▶].
3. Use [▲] and [▼] to select the setting you want, and then press [SET].

When connecting to this type of device:	Select this setting:
Computer	Mass Storage
PictBridge-compatible printer	PTP (PictBridge)

- Mass Storage causes the camera to see the computer as an external storage device. Use this setting for normal transfer of images from the camera to a computer (using the bundled Photo Loader application).
 - PTP (PictBridge) simplifies the transfer of image data to the connected device.
4. Check the battery level indicator to make sure that the battery is charged sufficiently, and then press the power button to turn off the camera.
 - If battery power is low, charge the battery or switch to AC power.

- To power the camera using AC power, you need to purchase an optionally available AC adaptor.
- The camera does not draw power over the USB cable.

5. Use the USB cable that comes with the camera to connect the camera to a printer.

- When connecting the USB cable to the camera, make sure the ▲ symbol on the camera’s [USB/AV] port is aligned with the ▲ symbol on the USB cable plug.

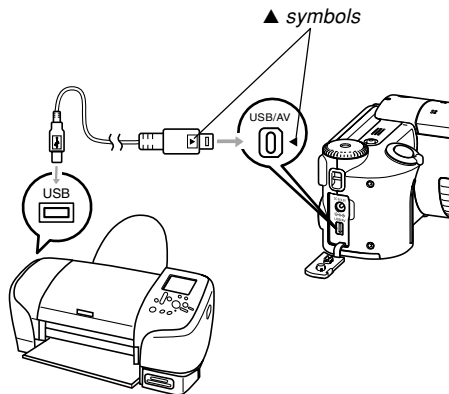

6. Turn on the printer.

7. Load paper for printing the images into the printer.

8. Press the camera's power button.

- This displays the print menu on the camera's monitor screen.

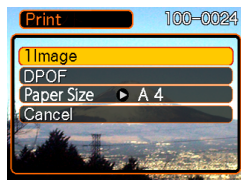

9. Use [▲] and [▼] to select “Paper Size”, and then press [▶].

10. Use [▲] and [▼] to select the paper size you want to use for printing, and then press [SET].

- The following are the print sizes that are available.
 - 3.5" × 5"
 - 5" × 7"
 - 4" × 6"
 - A4
 - 8.5" × 11"
 - By Printer
- Selecting “By Printer” prints using the paper size selected on the printer.
- Available paper size settings depend on the connected printer. For full details, see the instructions that come with your printer.

11. Use [▲] and [▼] to specify the print option you want.

- To print a single image: Select “1 Image” and then press [SET]. Next, use [◀] and [▶] to select the image you want to print.
- To print multiple images or all images: Select “DPOF”, and then press [SET]. Selecting this option will print the images selected with the DPOF settings. See page 176 for more information.
- You can toggle date stamping of the image on and off by pressing [DISP]. The  icon indicates that date stamping is turned on.

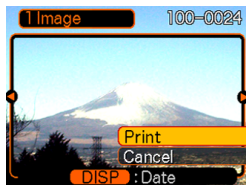

12. On the camera’s monitor screen, use [▲] and [▼] to select “Print”, and then press [SET].

- This starts printing and displays the message “Busy... Please wait...” on the monitor screen. The message will disappear after a short while, even though printing is still being performed. Pressing any of the camera’s buttons while printing is in progress will cause the message to reappear.
- The print menu will appear when printing is complete.
- If you selected “1 Image” in step 11, you can select another image for printing and then repeat this step to print.

13. After printing is complete, turn off the camera and then disconnect the USB cable from the camera.

Date Printing

Any one of the procedures described below can be used to include the recording date in image prints. Correct date printing requires that the current date be set on the camera before the image is recorded.

- Specifying date printing with DPOF settings (page 174)
 - Some printers may have settings that disable time stamp and/or DPOF printing. See the user documentation that comes with your printer for details about how to enable these features.
 - Note that some professional print services do not support DPOF printing. Check with your service before ordering prints.
- Specifying date printing with the Photohands software that comes with the camera
 - See page 23 of the Photohands User's Guide for details. The Photohands User's Guide is provided as a PDF file on the CD-ROM that comes bundled with your camera.
- Specifying date printing when having printing done by a print service
 - Some print services do not support date printing. Check with your service for more information.

■ Printing Precautions

- See the documentation that comes with your printer for information about print quality and paper settings.
- Contact your printer manufacturer for information about models that support PictBridge upgrades, etc.
- Never disconnect the USB cable, or perform any camera operation while printing is in progress. Doing so causes a printer error.

PRINT Image Matching III

Images include PRINT Image Matching III data (mode setting and other camera setup information). A printer that supports PRINT Image Matching III reads this data and adjusts the printed image accordingly, so your images come out just the way you intended when you recorded them.

* Seiko Epson Corporation holds the copyright for PRINT Image Matching and PRINT Image Matching III.



Exif Print

Exif Print is an internationally supported, open standard file format that makes it possible to capture and display vibrant digital images with accurate colors. With Exif 2.2, files include a wide range of shooting condition information that can be interpreted by an Exif Print printer to produce better-looking prints.



▶▶ IMPORTANT! ◀◀

- Information about the availability of Exif Print compatible printer models can be obtained from each printer manufacturer.

VIEWING IMAGES ON A COMPUTER

After using the USB cable to establish a USB connection between the camera and your computer, you can use your computer to view images in file memory and copy images to your computer's hard disk or other storage media. In order to establish a USB connection with a Windows computer, you first need to install the USB driver located on the CD-ROM that comes bundled with the camera onto your computer.

Note that the procedure you need to perform depends on whether you are using computer running under Windows (see below) or a Macintosh (see page 191).

Using the Camera with a Windows Computer

The following are the general steps for viewing and copying files from a computer running under Windows. You can find details about each operation in the procedures that follow below. Note that you should also refer to the documentation that comes with your computer for other information about USB connections, etc.

1. Load a fully charged battery into the camera, and connect the camera to the computer. Next, configure the required camera settings for USB connection to a computer.



2. Install the USB driver onto your computer.

- You need to perform this step only once, the first time you connect to your computer.



3. Use the USB cable to establish a connection between the camera and computer.



4. View and copy the images you want.

»» IMPORTANT! ««

- Low battery power can cause the camera to power down suddenly during data communication. Use of the special AC adaptor is recommended to power the camera during data communication.
- If you want to transfer files from the camera's built-in memory to a computer, make sure there is no memory card loaded in the camera before you connect the USB cable.
- This camera supports USB 2.0 Hi-Speed protocol. Though it can be used with a computer that supports only USB 1.1 protocol, higher speed data transfer becomes possible when USB 2.0 Hi-Speed is supported. Note that certain computer models, connecting through a USB hub, and other system conditions can slow down data transfer and even cause operational problems.



Do not try to establish a connection between the camera and computer before installing the USB driver onto the computer. If you do, the computer will not be able to recognize the camera.

VIEWING IMAGES ON A COMPUTER

1. Make sure the camera's battery is charged sufficiently.

- To power the camera using AC power, you need to purchase an optionally available AC adaptor.

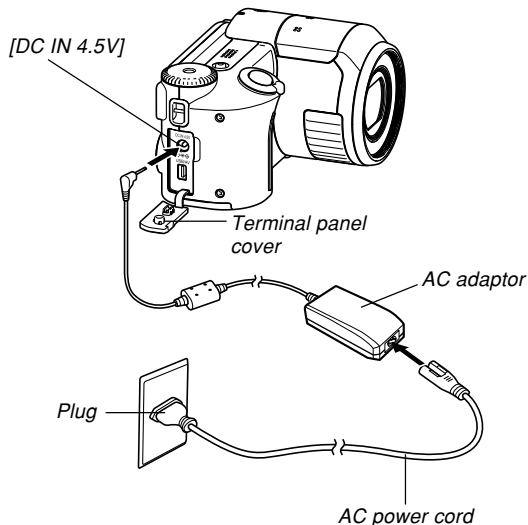

2. Turn on the camera, and then press [MENU].

- It makes no difference whether the camera is in a REC mode or the PLAY mode.

3. Select the "Set Up" tab, select "USB", and then press [▶].

4. Use [▲] and [▼] to select "Mass Storage", and then press [SET].

5. Set the bundled CD-ROM into the CD-ROM drive of your computer.

- Use the CD-ROM whose contents label shows "USB driver".

6. On the menu screen that appears, click “English”.
7. Click [USB driver C] and then [Install].
 - This starts installation.
 - Follow the instructions that appear on your computer screen to complete the installation.
 - The following steps show installation under the English version of Windows.
8. When the final setup screen appears, click the [Exit] button on the CD-ROM menu to exit the menu, and then remove the CD-ROM from your computer.
 - With some computer operating systems, a message prompting you to restart your computer may appear. If this happens, restart your computer. The CD-ROM menu will appear again after your computer restarts. Click the [Exit] button on the CD-ROM menu to exit the menu, and then remove the CD-ROM from your computer.

9. Turn off the camera, and connect the USB cable that comes bundled with the camera to the camera’s [USB/AV] port and your computer’s USB port.
 - When connecting the USB cable to the camera, make sure the ▲ symbol on the camera’s [USB/AV] port is aligned with the ▲ symbol on the USB cable plug.

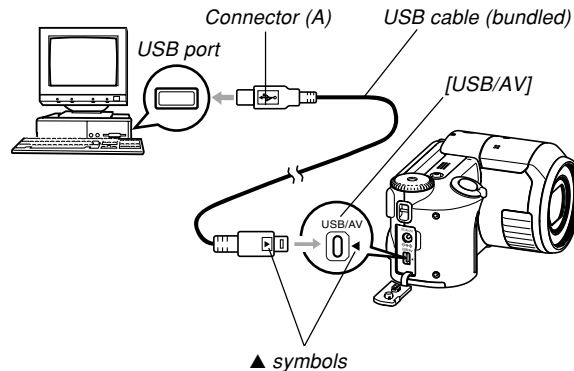

VIEWING IMAGES ON A COMPUTER

- Take care when connecting the USB cable to the camera or your computer. USB ports and cable plugs are shaped for proper positioning.
- Plug the USB cable plugs into the ports securely, as far as they will go. Proper operation is not possible if connections are not correct.

10. Turn on the camera.

- If your computer is running Windows 98, 98SE, Me, or 2000, it will automatically recognize the memory card loaded in the camera or the camera's memory.
- If your computer is running Windows XP, the "Found New Hardware Wizard" dialog box will appear. Select "Install the software automatically (Recommended)", and then click [Next]. The "Casio Digital Camera C has not passed Windows Logo testing to verify its compatibility with Windows XP." message will appear during installation. CASIO has verified compatibility, so click [Continue Anyway] to proceed with installation.
- If your computer is running Windows XP-SP2, the "Found New Hardware Wizard" dialog box will appear. Select "No, not this time", and then click [Next]. Select "Install the software automatically (Recommended)" and then click [Next]. The "Casio Digital Camera C has not passed Windows Logo testing to verify its compatibility with Windows XP." message will appear during installation. CASIO has verified compatibility, so click [Continue Anyway] to proceed with installation.

- This will cause your computer to create a hardware profile for camera's built-in memory or the memory card loaded in the camera. You do not need to install the USB driver every time. After you install it once, your computer will recognize the camera's built-in memory or its memory card when you connect the camera using the USB cable.
- This will cause the camera's operation lamp to light green.

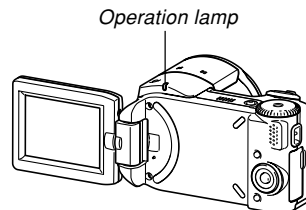

- At this point, some operating systems will display a "Removable Disk" dialog box. If your operating system does, close the dialog box.

11. On your computer, double-click “My Computer”.

- If you are running Windows XP, click [Start] and then [My Computer].

12. Double-click “Removable Disk”.

- Your computer sees the camera’s file memory as a removable disk.

13. Double-click the “Dcim” folder.

14. Double-click the folder that contains the image you want.

15. Double-click the file that contains the image you want to view.

- For information about file names, see “Memory Folder Structure” on page 197.

NOTE

- If you open a rotated image on your computer, the original unrotated version will appear (page 146). This is true both for a rotated image opened from camera memory and for a rotated image that has been copied to your computer’s hard disk.

16. Depending on your operating system, perform one of the following procedures to save the files, if you want.

Windows 98, 2000, Me

1. In the camera's file memory (Removable Disk), right-click the "Dcim" folder.
 2. On the shortcut menu that appears, click [Copy].
 3. Double click [My Documents] to open it.
 4. On the My Documents [Edit] menu, click [Paste].
- This copies the "Dcim" folder (which contains the image files) to your "My Documents" folder.

Windows XP

1. In the camera's file memory (Removable Disk), right-click the "Dcim" folder.
 2. On the shortcut menu that appears, click [Copy].
 3. Click [Start] and then [My Documents].
 4. On the My Documents [Edit] menu, click [Paste].
- This copies the "Dcim" folder (which contains the image files) to your "My Documents" folder.

▶▶ IMPORTANT! ◀◀

- Never use your computer to edit, delete, move, or rename images stored in the camera's file memory. Doing so can cause problems with the image management data used by the camera, which may make it impossible to display images on the camera or it may cause large error in the number of images value displayed by the camera. Always copy images to your computer before performing any edit, delete, move, or rename operation.

17. Depending on the version of Windows you are running, use one of the following procedures to terminate the USB connection.

Windows 98/XP Users

- Press the camera's power button. After making sure that the camera's green operation lamp is not lit, disconnect the camera from the computer.

Windows Me/2000 Users

- Click card services in the task tray on your computer screen, and disable the drive number assigned to the camera. Next, disconnect the USB cable from the camera, and then turn off the camera.

■ USB Connection Precautions

- Do not leave the same image displayed on your computer screen for a long time. Doing so can cause the image to "burn in" on the screen.
- Never disconnect the USB cable, or perform any camera operation while data communication is in progress. Doing so can cause data to become corrupted.

Using the Camera with a Macintosh Computer

The following are the general steps for viewing and copying files from a Macintosh.

You can find details about each operation in the procedures that follow below. Note that you should also refer to the documentation that comes with your Macintosh for other information about USB connections, etc.

▶▶ IMPORTANT! ◀◀

- Movie files cannot be played back on a Macintosh.
- This camera does not support operation on a computer running Mac OS 8.6 or lower, or Mac OS X 10.0. If you have a Macintosh running Mac OS 9 or OS X (10.1, 10.2, or 10.3), use the standard USB driver that comes with your OS.

1. Load a fully charged battery into the camera, and configure the required camera settings for USB connection to a computer.



2. Use the USB cable to establish a connection between the camera and your Macintosh.



3. View and copy the images you want.

►► IMPORTANT! ◀◀

- Low battery power can cause the camera to power down suddenly during data communication. Use the optional AC adaptor is recommended to power the camera during data communication with a computer.
- If you want to transfer files from the camera's built-in memory to a computer, make sure there is no memory card loaded in the camera before you connect the USB cable.
- This camera supports USB 2.0 Hi-Speed protocol. Though it can be used with a computer that supports only USB 1.1 protocol, higher speed data transfer becomes possible when USB 2.0 Hi-Speed is supported. Note that certain computer models, connecting through a USB hub, and other system conditions can slow down data transfer and even cause operational problems.



1. Make sure the camera's battery is charged sufficiently.

- To power the camera using AC power, you need to purchase an optionally available AC adaptor.

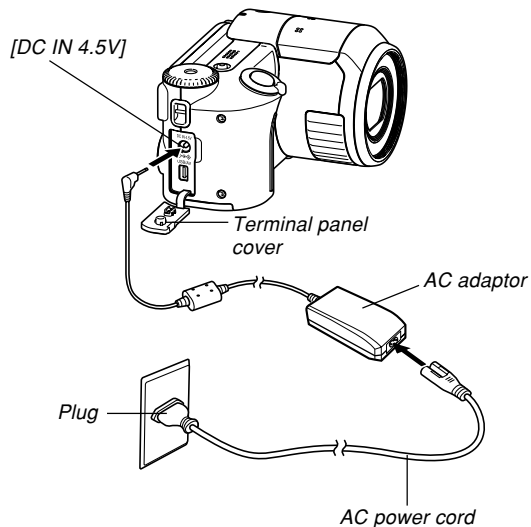

VIEWING IMAGES ON A COMPUTER

2. Turn on the camera, and then press [MENU].
 - It makes no difference whether the camera is in a REC mode or the PLAY mode.
3. Select the “Set Up” tab, select “USB”, and then press [▶].
4. Use [▲] and [▼] to select “Mass Storage”, and then press [SET].

5. Turn off the camera, and connect the USB cable that comes bundled with the camera to the camera’s [USB/AV] port and your computer’s USB port.

- When connecting the USB cable to the camera, make sure the ▲ symbol on the camera’s [USB/AV] port is aligned with the ▲ symbol on the USB cable plug.

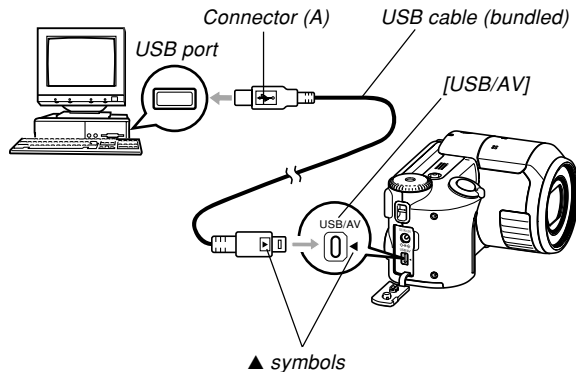

- Take care when connecting the USB cable to the camera or your computer. USB ports and cable plugs are shaped for proper positioning.
- Plug the USB cable plugs into the ports securely, as far as they will go. Proper operation is not possible if connections are not correct.

6. Turn on the camera.

- Your Macintosh will see the camera's file memory as a drive.
- The appearance of the drive icon depends on the Mac OS version you are using.
- Your Macintosh will see the camera's file memory as a drive whenever you establish a USB connection between the camera and your Macintosh.

7. Double-click the drive icon for the camera's file memory, the "DCIM" folder, and then the folder that contains the image you want.

8. Double-click the file that contains the image you want to view.

- For information about file names, see "Memory Folder Structure" on page 197.

»» NOTE ««

- If you open a rotated image on your Macintosh, the original unrotated version will appear (page 146). This is true both for a rotated image opened from camera memory and for a rotated image that has been copied to your Macintosh hard disk.

9. To copy all the files in file memory to your Macintosh hard disk, drag the "DCIM" folder to the folder to which you want to copy it.

▶▶ IMPORTANT! ◀◀

- Never use your computer to edit, delete, move, or rename images stored in the camera's file memory. Doing so can cause problems with the image management data used by the camera, which may make it impossible to display images on the camera or it may cause large error in the number of images value displayed by the camera. Always copy images to your computer before performing any edit, delete, move, or rename operation.

10. To terminate the USB connection, drag the drive icon that represents the camera to Trash. Next, disconnect the USB cable from the camera, and then turn off the camera.

■ USB Connection Precautions

- Do not leave the same image displayed on your computer screen for a long time. Doing so can cause the image to “burn in” on the screen.
- Never disconnect the USB cable, or perform any camera operation while data communication is in progress. Doing so can cause data to become corrupted.

Using a Memory Card to Transfer Images to a Computer

The procedures in this section describe how to transfer images from the camera to your computer using a memory card.

Using a Computer with a Built-in SD Memory Card Slot

Insert the SD memory card directly into the slot.

Using a Computer with a Built-in PC Card Slot

Use a commercially available PC card adaptor (for an SD memory card or MMC). For full details, see the user documentation that comes with the PC card adaptor and your computer.

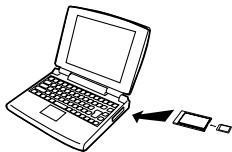

Using a Commercially Available SD Memory Card Reader/Writer

See the user documentation that comes with the SD memory card reader/writer for details about how to use it.

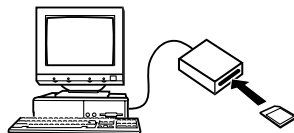

Using a Commercially Available PC Card Reader/Writer and PC Card Adaptor (for an SD memory card or MMC)

See the user documentation that comes with the PC card reader/writer and PC card adaptor for details about how to use them.

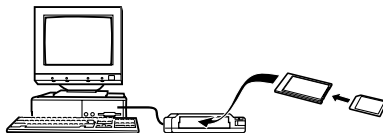

Memory Data

Images recorded with this camera and other data are stored in memory using DCF (Design rule for Camera File system) protocol. DCF protocol is designed to make it easier to exchange image and other data between digital cameras and other devices.

DCF Protocol

DCF devices (digital cameras, printers, etc.) can exchange images with each other. DCF protocol defines a format for image file data and the folder structure for file memory, so images can be viewed using another manufacturer's DCF camera or printed on a DCF printer.

Memory Folder Structure

■ Folder Structure

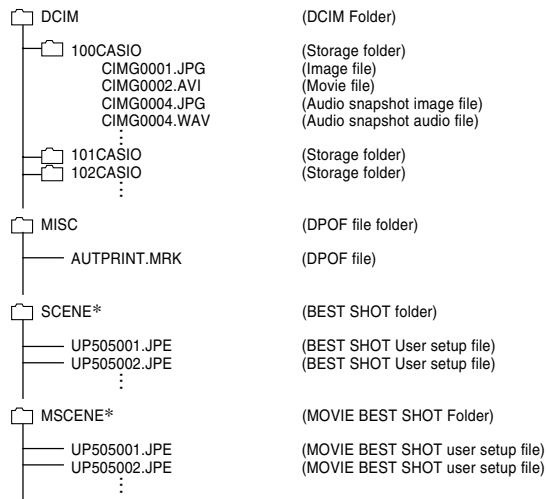

* These folders are created in built-in memory only.

■ Folder and File Contents

- DCIM folder
Folder that stores all of the digital camera files
 - Storage folder
Folder for storing files created by the digital camera
 - Image file
File that contains an image recorded with the digital camera (File Name Extension: JPG)
 - Movie file
File that contains a movie recorded with the digital camera (File Name Extension: AVI)
 - Audio snapshot image file
File that contains the image part of an audio snapshot (File Name Extension: JPG)
 - Audio snapshot audio file
File that contains the audio part of an audio snapshot (File Name Extension: WAV)
- DPOF file folder
Folder that contains DPOF files
 - BEST SHOT folder (Built-in memory only)
Folder that contains BEST SHOT user setup files
 - BEST SHOT user setup files (Built-in memory only)
Files that contain BEST SHOT user setups
 - MOVIE BEST SHOT folder (Built-in memory only)
Folder that contains MOVIE BEST SHOT user setup files
 - MOVIE BEST SHOT user setup files (Built-in memory only)
Files that contain MOVIE BEST SHOT user setups

Image Files Supported by the Camera

- Image files recorded with this camera
- DCF protocol image files

Certain DCF functions may not be supported. When displaying an image recorded on another camera model, it may take a long time for the image to appear on the display.

■ Built-in Memory and Memory Card Precautions

- Note that the folder named “DCIM” is the parent (top) folder of all the files in memory. When transferring memory contents to a hard disk, CD-R, MO disk, or other external storage, treat all the contents inside a DCIM folder as a set and always keep them together. You can change the name of the DCIM folder on your computer. Changing the name to a date is a good way to keep track of multiple DCIM folders. However, if you even want to copy the folders back to the camera’s file memory, be sure you change the name of the DCIM folder back to “DCIM” first. The camera does not recognize any folder name other than DCIM.
- Folders and files must be stored in accordance with the “Folder Structure” shown on page 197 in order for the camera to be able to recognize them correctly.

USING THE CAMERA WITH A COMPUTER

This section explains the software and applications on the CD-ROM that comes bundled with the camera, and provides an overview of what you can do with them.

Note that the procedure you need to perform depends on whether you are using computer running under Windows (see below) or a Macintosh (see page 215).

Using the Camera with a Windows Computer

Your digital camera comes bundled with useful applications for using it in combination with a computer. Install the applications you need on your computer.

About the bundled CD-ROM

The CD-ROM that comes bundled with the camera contains the applications described below. Installation of these applications is optional, and you should install only the ones you want to use.

Purpose	CD-ROM Software		
	Software Name	Supported Windows Versions	Required Operation
USB connection to a computer for image transfer	USB driver Type C	XP/2000/Me/98SE/98	Install the USB driver (page 183).
Management of images transferred to a computer	Photo Loader 2.3 * DirectX 9.0c	XP/2000/Me/98SE/98	Install Photo Loader 2.3. * If the computer does not have DirectX 9.0 or higher installed, install DirectX 9.0c (page 204).
Snapshot retouching, reorientation, printing	Photohands 1.0	XP/2000/Me/98SE/98	Install Photohands 1.0 (page 207).

USING THE CAMERA WITH A COMPUTER

Purpose	CD-ROM Software		
	Software Name	Supported Windows Versions	Required Operation
Movie playback	Windows Media Player 9 * DirectX 9.0c	XP/2000/Me/98SE	<ul style="list-style-type: none"> • If you can connect to the Internet Connect to the Internet for automatic installation for the applicable codec (page 209). • If you cannot connect to the Internet Install Windows Media Player 9 (page 210). * If you are running Windows 2000 or 98SE with a DirectX version that is lower than 9.0c, install DirectX 9.0c (page 206).
	Windows 98 WMP6.4 codec	98	<ul style="list-style-type: none"> • If you can connect to the Internet Connect to the Internet for automatic installation for the applicable codec (page 209). • If you cannot connect to the Internet, install the Windows 98 WMP6.4 codec (page 211).
Movie editing	Ulead Movie Wizard SE VCD	XP/2000	Install Ulead Movie Wizard SE VCD (page 212).
	–	Me/98SE/98	–
Viewing of user documentation (PDF) files	Adobe Reader 6.0	XP/2000/Me/98SE	If your computer does not already have Adobe Reader or Adobe Acrobat Reader installed, install Adobe Reader 6.0 (page 213).
	–	98	If your computer does not already have Adobe Reader or Adobe Acrobat Reader installed, go to the Adobe Systems Incorporated website and install Acrobat Reader 5.0.5.

Computer System Requirements

Computer system requirements are different for each of the applications. Be sure to check the requirements for the particular application you are trying to use. Note that the values provided here are minimum requirements for running each application. Actual requirements are greater, depending on the number of images and the sizes of the images being handled.

USB driver Type C

OS: XP/2000/Me/98SE/98

In the case of Windows 2000, XP or Me, you install a data file that enables use of the operating system's standard USB driver. You do not install a special USB driver. Proper operation is not guaranteed on a computer that has been upgraded from Windows 95 or 3.1 to another version of Windows.

Photo Loader 2.3

OS: XP/2000/Me/98SE/98

Memory: At least 16MB

HD: At least 7MB

Other: Internet Explorer 5.5 or higher; DirectX 9.0 or higher

These are the minimum system requirements to run the application. Actual requirements are greater, depending on the number of images and the sizes of the images being handled.

Photohands 1.0

OS: XP/2000/Me/98SE/98

Memory: At least 64MB

HD: At least 10MB

DirectX 9.0c

OS: XP/2000/Me/98SE/98

HD: At least 65MB free space during installation, 18MB after installation is complete.

Adobe Reader 6.0

OS: XP/2000/Me/98SE

CPU: Pentium

Memory: 32MB

HD: 60MB

Other: Internet Explorer 5.01 or higher

Windows Media Player 9

OS: XP/2000/Me/98SE

CPU: 233 MHz Intel Pentium II, AMD, etc.

Memory: 64MB

HD: 100MB

Other: Sound card; 800 × 600 or greater display resolution; Internet Explorer 5.01 or higher

- If you are running Windows 98, install the Windows 98 WMP6.4 codec from the CD-ROM.

Ulead Movie Wizard SE VCD

OS: XP/2000

CPU: Pentium III 800MHz

Memory: 256MB

HD: 250MB

Other: 1024 × 768 or higher display resolution

▶▶ IMPORTANT! ◀◀

- For details about Windows minimum system requirements, see the “Read me” file on the CD-ROM that comes bundled with the camera.

Managing Images on a PC

To manage images on a PC, you need to install the Photo Loader application from the CD-ROM that comes with the camera.

- Use the CD-ROM whose contents label shows “Photo Loader”.

»» NOTE ««

- If you already have Photo Loader installed on your computer, check its version. If the bundled version is newer than the one you have, uninstall the old version of Photo Loader and then install the newer version.

The CD-ROM includes the software and user documentation for various languages. Check the CD-ROM menu screen to see if applications and user documentation are available for a particular language.

■ Getting Started

Start up your computer and insert the CD-ROM into its CD-ROM drive. This will automatically launch the menu application, which displays a menu screen on your computer.

- The menu application may not start up automatically on some computers. If this happens, navigate to the CD-ROM and double-click “menu.exe” to launch the menu application.

■ Selecting a Language

First select a language. Note that some software is not available in all languages.

- 1. On the menu screen, click the tab for the language you want.**

■ Viewing the Contents of the “Read me” File

You should always read the “Read me” file for “Photo Loader” before installing it. The “Read me” file contains information you need to know when installing the application.

1. Click the “Read me” button for “Photo Loader”.

»» IMPORTANT! ««

- Before upgrading or reinstalling Photo Loader, or before installing it onto another computer, be sure to read the “Read me” file for information about retaining existing libraries.

■ Installing Photo Loader

1. Click the “Install” button for “Photo Loader”.
2. Follow the instructions that appear on your computer screen.

»» IMPORTANT! ««

- Be sure to follow the instructions carefully and completely. If you make a mistake when installing Photo Loader, you may not be able to browse your existing library information and HTML files that are created automatically by Photo Loader. In some cases, image files may be lost.

■ Checking for the Proper Version of DirectX

In order to manage images using Photo Loader, your computer also needs to have DirectX 9.0 or higher installed. You can check the installed version of DirectX using your PC's DirectX Diagnostic Tool.

- 1. On your PC, click [Start], [All Programs], [Accessories], [System Tools], and then [System Information].**
- 2. On the [Tools] menu of the window that appears, select [DirectX Diagnostic Tool].**
- 3. On the [System] tab, check to make sure that the version shown for the "DirectX Version" item is 9.0 or higher.**

4. Click [Exit] to exit DirectX Diagnostic Tool.

- If your PC already has DirectX 9.0 or higher installed, you do not need to install DirectX 9.0c from the bundled CD-ROM.
- If your PC does not have DirectX 9.0 or higher installed, install DirectX 9.0c from the bundled CD-ROM.

Retouching, Reorienting, and Printing a Snapshot

In order to retouch, reorient, or print snapshots on your PC, you need to install Photohands from the CD-ROM that comes bundled with the camera.

- Use the CD-ROM whose contents label shows “Photohands”.

»» NOTE ««

- If you already have Photohands installed on your computer, check its version. If the bundled version is newer than the one you have, uninstall the old version of Photohands and then install the newer version.

The CD-ROM includes the software and user documentation for various languages. Check the CD-ROM menu screen to see if applications and user documentation are available for a particular language.

■ Getting Started

Start up your computer and insert the CD-ROM into its CD-ROM drive. This will automatically launch the menu application, which displays a menu screen on your computer.

- The menu application may not start up automatically on some computers. If this happens, navigate to the CD-ROM and double-click “menu.exe” to launch the menu application.

■ Selecting a Language

First select a language. Note that some software is not available in all languages.

- 1. On the menu screen, click the tab for the language you want.**

■ Viewing the Contents of the “Read me” File

You should always read the “Read me” file for “Photohands” before installing it. The “Read me” file contains information you need to know when installing the application.

1. Click the “Read me” button for “Photohands”.

■ Installing Photohands

1. Click the “Install” button for “Photohands”.
2. Follow the instructions that appear on your computer screen.

Playing a Movie

In order to play a movie recorded with this camera on your PC using Windows Media Player, you need to install MPEG-4 codec.

■ To install the codec on a PC that can connect to the Internet

1. Connect the PC to the Internet.
2. Click the movie file that was recorded with the camera.
3. If your PC does not have MPEG-4 codec installed, it will connect to the Microsoft website automatically and download the codec.
4. Install the downloaded MPEG-4 codec.

5. This will cause the movie file recorded with the camera to start playing.

»» NOTE ««

- If your PC already has MPEG-4 codec installed, it will start playing the movie as soon as you click it.
 - If you are using Windows Media Player 8 or 9, perform the following steps in order to ensure stable movie display.
1. On the Windows Media Player [Tools] menu, select [Options]. On the dialog box that appears, open the [Performance] tab.
 2. In the “Video acceleration” area click [Advanced].
 3. In the “Video acceleration” area, clear the “Use video mixing renderer” check box.
 4. In the “Legacy video renderer” area, clear the “Use YUV Flipping” check box.

■ To install the codec on a PC that cannot connect to the Internet

If your PC cannot connect to the Internet, install Windows Media Player 9 from the CD-ROM that comes bundled with the camera.

- Use the CD-ROM whose contents label shows “Windows Media Player 9”.

● Getting Started

Start up your computer and insert the CD-ROM into its CD-ROM drive. This will automatically launch the menu application, which displays a menu screen on your computer.

- The menu application may not start up automatically on some computers. If this happens, navigate to the CD-ROM and double-click “menu.exe” to launch the menu application.

● Selecting a Language

First select a language. Note that some software is not available in all languages.

- 1. On the menu screen, click the tab for the language you want.**

● Viewing the Contents of the “Read me” File

You should always read the “Read me” file for “Windows Media Player 9” before installing it. The “Read me” file contains information you need to know when installing the application.

1. Click the “Read me” button for “Windows Media Player 9”.

● Installing Windows Media Player 9

1. Click the “Install” button for “Windows Media Player 9”.

2. Follow the instructions that appear on your computer screen.

▶▶ IMPORTANT! ◀◀

- If your PC is running Windows 98, install the Windows 98 WMP6.4 codec instead of Windows Media Player 9.
- In the case of Windows 2000 or 98SE, you need to install DirectX 9.0c. For information about determining the version of DirectX on your PC, see page 206.
- If your computer has Windows Media Player 9 installed, perform the following steps in order to ensure stable movie display.
 1. On the Windows Media Player [Tools] menu, select [Options]. On the dialog box that appears, open the [Performance] tab.
 2. In the “Video acceleration” area click [Advanced].
 3. In the “Video acceleration” area, clear the “Use video mixing renderer” check box.
 4. In the “Legacy video renderer” area, clear the “Use YUV Flipping” check box.

Editing a Movie

In order to edit movies on your PC, you need to install Ulead Movie Wizard SE VCD from the bundled CD-ROM.

- Use the CD-ROM whose contents label shows “Ulead Movie Wizard SE VCD”.

▶▶ IMPORTANT! ◀◀

- Operation of Ulead Movie Wizard SE VCD is not supported under Windows Me, 98SE, or 98.

▶▶ NOTE ◀◀

- The Ulead Movie Wizard SE VCD application that comes on the bundled CD-ROM can create Video-CDs, but it cannot create DVDs. If you want to be able to create DVDs, you need to upgrade to the commercial version. See the “Readme” file on the CD-ROM for information about Ulead Movie Wizard SE VCD, and what you need to do to upgrade to the commercial version.

■ Getting Started

Start up your computer and insert the CD-ROM into its CD-ROM drive. This will automatically launch the menu application, which displays a menu screen on your computer.

- The menu application may not start up automatically on some computers. If this happens, navigate to the CD-ROM and double-click “menu.exe” to launch the menu application.

■ Selecting a Language

First select a language. Note that some software is not available in all languages.

- 1. On the menu screen, click the tab for the language you want.**

■ Viewing the Contents of the “Read me” File

You should always read the “Read me” file for “Ulead Movie Wizard SE VCD” before installing it. The “Read me” file contains information you need to know when installing the application.

1. Click the “Read me” button for “Ulead Movie Wizard SE VCD”.

■ Installing Ulead Movie Wizard SE VCD

1. Click the “Install” button for “Ulead Movie Wizard SE VCD”.
2. Follow the instructions that appear on your computer screen.

Viewing User Documentation (PDF Files)

1. In the “Manual” area, click the name of the manual you want to read.

▶▶ IMPORTANT! ◀◀

- You must have Adobe Reader or Adobe Acrobat Reader installed on your computer in order to view the contents of a PDF file. If you do not already have Adobe Reader installed, you can install it from the bundled CD-ROM.

User Registration

You can perform user registration over the Internet. To do so, of course, you need to be able to connect to the Internet with your computer.

1. Click the “Registration” button.

- This starts up your Web browser and accesses the user registration website. Follow the instructions that appear on your computer screen to register.

Exiting the Menu Application

- 1. On the menu screen, click “Exit” to exit the menu.**

Using the Camera with a Macintosh Computer

Your digital camera comes bundled with useful applications for using it in combination with a computer. Install the applications you need on your computer.

About the bundled CD-ROM

The CD-ROM that comes bundled with the camera contains the applications described below. Installation of these applications is optional, and you should install only the ones you want to use.

Purpose	CD-ROM Software		
	For the Macintosh	Mac OS Versions	Required Operation
USB connection to a Macintosh for image transfer	–	OS 9/OS X	Use the USB cable to connect the camera to your Macintosh. USB driver is not required (page 191).
Managing of Images on a Macintosh	Photo Loader 1.1	OS 9	Install Photo Loader 1.1 (page 217).
	–	OS X	Use iPhoto, which comes bundled with your operating system (page 217).
Viewing of user documentation (PDF) files	–	OS 9/OS X	Use Adobe Reader or Adobe Acrobat reader, which comes bundled with your operating system (page 218).

▶▶ IMPORTANT! ◀◀

- Movie files cannot be played back on a Macintosh.

Computer System Requirements

Computer system requirements are different for each of the applications. Be sure to check the requirements for the particular application you are trying to use. Note that the values provided here are minimum requirements for running each application. Actual requirements are greater, depending on the number of images and the sizes of the images being handled.

Photo Loader 1.1

OS: 9

Memory: 32MB

HD: At least 3MB

- USB connection is supported on a Macintosh running OS 9 or X. Operation is supported using the standard USB driver that comes with the operating system, so all you need to do is connect the camera to your Macintosh using the USB cable.

▶▶ IMPORTANT! ◀◀

- For details about Macintosh minimum system requirements, see the “Readme” file on the CD-ROM that comes bundled with the camera.
- The software on the CD-ROM that comes bundled with the camera does not support operation under Mac OS X.

Managing Images on a Macintosh

■ To manage images on a Macintosh running OS 9

Install the Photo Loader application from the CD-ROM that comes with the camera.

- Use the CD-ROM whose contents label shows “Photo Loader”.

● To install Photo Loader

1. Open the folder named “Photo Loader”.
2. Open the folder named “English”, and then open the file named “Important”.
3. Open the folder named “Installer”, and then open the file named “readme”.
4. Follow the instructions in the “readme” file to install Photo Loader.

►► IMPORTANT! ◀◀

- If you are upgrading to the new version of Photo Loader from a previous version and you want to use library management data and HTML files created using the old version of Photo Loader, be sure to read the “Important” file in the “Photo Loader” folder. Follow the instructions in the file to use your existing library management files. Failure to follow this procedure correctly can result in loss or corruption of your existing files.
- Movie files cannot be played back on a Macintosh.

■ To manage images on a Macintosh running OS X

Use iPhoto, which comes bundled with the operating system. iPhoto enables management of snapshots.

Viewing User Documentation (PDF Files)

You must have Adobe Reader or Adobe Acrobat Reader installed on your computer in order to view the contents of a PDF file.

If you don't, go to the Adobe Systems Incorporated website and install Acrobat Reader.

■ To view the camera user's guide

1. On the CD-ROM, open the "Manual" folder.
2. Open the "Digital Camera" folder, and then open the folder for the language whose user's guide you want to view.
3. Open the file named "camera_xx.pdf".
 - "xx" is the language code (Example: camera_e.pdf is for English.)

■ To view the Photo Loader user's guide

1. On the CD-ROM, open the "Manual" folder.
2. Open the "Photo Loader" folder and then open the "English" folder.
3. Open "PhotoLoader_english".

To register as a camera user

Internet registration only is supported. Visit the following CASIO website to register:

<http://world.casio.com/qv/register/>

APPENDIX









Menu Reference

The following shows lists of menus that appear in REC modes and the PLAY mode, and their settings.

- The settings that are underlined in the following table are initial defaults.

■ REC Modes

● REC Tab Menu



Self-timer	10 sec / 2 sec / X3 / <u>Off</u>
Size	<u>2560 × 1920</u> / 2560 × 1712 (3:2) / 2048 × 1536 / 1600 × 1200 / 1280 × 960 / 640 × 480
 Quality (Snapshots)	Fine / <u>Normal</u> / Economy
 Quality (Movies)	<u>HQ</u> / Normal / LP
EV Shift	-2.0 / -1.7 / -1.3 / -1.0 / -0.7 / -0.3 / <u>0.0</u> / +0.3 / +0.7 / +1.0 / +1.3 / +1.7 / +2.0
White Balance	<u>Auto</u> /  (Daylight) /  (Cloudy) /  (Shade) /  (Fluorescent 1) /  (Fluorescent 2) /  (Tungsten) /  (Flash) / Manual
ISO	<u>Auto</u> / ISO 50 / ISO 100 / ISO 200 / ISO 400

AF Area	<u>Spot</u> / Multi / Free
Metering	<u>Multi</u> / Center weighted / Spot
Audio Snap	On / <u>Off</u>
Filter	<u>Off</u> / B/W / Sepia / Red / Green / Blue / Yellow / Pink / Purple
Sharpness	+2 / +1 / <u>0</u> / -1 / -2
Saturation	+2 / +1 / <u>0</u> / -1 / -2
Contrast	+2 / +1 / <u>0</u> / -1 / -2
Flash Intensity	+2 / +1 / <u>0</u> / -1 / -2
Flash Assist	<u>Auto</u> / Off
Grid	On / <u>Off</u>
Digital Zoom	<u>On</u> / Off
Review	<u>On</u> / Off
Icon Help	<u>On</u> / Off
L/R Key	<u>EV shift</u> / White Balance / ISO / Metering / Self-timer / Off

● Memory Tab Menu



Flash	<u>On</u> / Off
Focus	On / <u>Off</u>
White Balance	On / <u>Off</u>
ISO	On / <u>Off</u>
AF Area	<u>On</u> / Off
Metering	On / <u>Off</u>
Self-timer	On / <u>Off</u>
Flash Intensity	On / <u>Off</u>
Digital Zoom	<u>On</u> / Off
MF Position	On / <u>Off</u>
Zoom Position	On / <u>Off</u>

● Set Up Tab Menu

Sounds	<u>Startup</u> / Half Shutter / Shutter / Operation /  Operation /  Play
File No.	<u>Continue</u> / Reset
World Time	<u>Home</u> / World
	Home Time setup (city, DST, etc.)
	World Time setup (city, DST, etc.)
Date Style	YY/MM/DD / DD/MM/YY / MM/DD/YY
Adjust	Time setting
Language	日本語 / English / Français / Deutsch / Español / Italiano / Português / 中國語 / 中国語 / 한국어
Sleep	30 sec / <u>1 min</u> / 2 min / Off
Auto Power Off	<u>2 min</u> / 5 min
USB	<u>Mass Storage</u> / PTP (PictBridge)
Video Out	<u>NTSC</u> / PAL
Format	Format / <u>Cancel</u>
Reset	Reset / <u>Cancel</u>

■ PLAY Mode

● PLAY Tab Menu

Slideshow	<u>Start</u> / Images / Time / Interval / Cancel
MOTION PRINT	9 frames / 1 frame / <u>Cancel</u>
Movie Editing	 Cut (Before) /  Cut (Between) /  Cut (After) / <u>Cancel</u>
DPOF	<u>Select images</u> / All images / Cancel
Protect	<u>On</u> / All Files : On / Cancel
Rotation	<u>Rotate</u> / Cancel
Resize	<u>1600 × 1200</u> / 1280 × 960 / 640 × 480 / Cancel
Trimming	–
Dubbing	–
Copy	<u>Built-in</u> → Card / Card → Built-in / Cancel

● Set Up Tab Menu

- The contents of the PLAY mode set up tab menu are identical to those of the REC mode set up tab menu.

Indicator Lamp Reference

The camera has two indicator lamps: an operation lamp and a self-timer lamp. These lamps light and flash to indicate the current operational status of the camera.

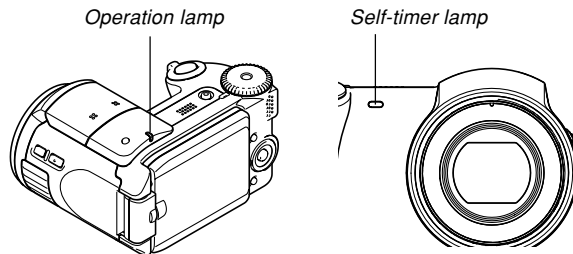

- * There are three lamp flash patterns. Pattern 1 flashes once per second, Pattern 2 flashes twice per second, and Pattern 3 flashes four times per second. The table below explains what each flash pattern indicates.

■ REC Modes

Operation Lamp		Self-timer Lamp	Meaning
Green	Red	Red	
Lit			Operational (Power on, recording enabled)
	Pattern 3		Flash is charging.
	Lit		Flash charging is complete.
Lit			Auto Focus operation was successful.
Pattern 3			Cannot Auto Focus.
Lit			Sleep state.
Pattern 2			Storing image
Pattern 1			Storing movie data / processing image data
		Pattern 1	Self-timer countdown (10 to 3 seconds)
		Pattern 2	Self-timer countdown (3 to 0 seconds)
	Pattern 1		Cannot charge flash.

Operation Lamp		Self-timer Lamp	Meaning
Green	Red	Red	
	Pattern 2		Memory card problem / Memory card is unformatted. / BEST SHOT setup cannot be registered.
	Lit		Memory card is locked. / Cannot create folder. / Memory is full. / Write error
	Pattern 3		Low battery alert
Pattern 3			Formatting card
Pattern 3			Powering down

))) IMPORTANT! (((

- When you are using a memory card, never remove the card from the camera while the green operation lamp is flashing. Doing so will cause recorded images to be lost.

■ PLAY Mode

Operation Lamp		Self-timer Lamp	Meaning
Green	Red	Red	
Lit			Operational (Power on, recording enabled)
Pattern 3			One of the following operations is being performed: delete, DPOF, image protect, copy, format, power down, image resizing, image trimming, after recording, MOTION PRINT, movie editing
	Pattern 2		Memory card problem / Memory card is unformatted.
	Lit		Memory card is locked. / Cannot create folder. / Memory is full.
	Pattern 3		Low battery alert

■ Rapid Charger

The rapid charger has a [CHARGE] lamp that lights or flashes in accordance with the rapid charger operation that is being performed.

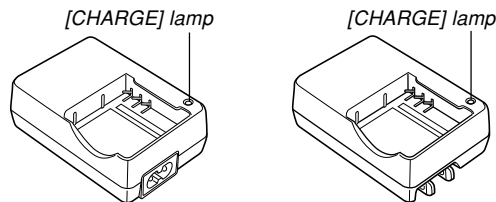







[CHARGE] Lamp		Meaning
Color	Status	
Red	Lit	Charging
Green	Lit	Charging complete
Red	Flashing	Rapid charger or battery abnormality
Amber	Lit	Charge standby state (Ambient temperature is too high or too low.)

Troubleshooting Guide

	Symptom	Possible Cause	Action
Power Supply	Power does not turn on.	<ol style="list-style-type: none"> 1) The battery is not oriented correctly. 2) The battery is dead. 	<ol style="list-style-type: none"> 1) Orient the battery correctly (page 42). 2) Charge the battery (page 37). If the battery goes dead soon after being charged, it means the battery has reached the end of its life and needs to be replaced. Purchase a separately available NP-40 rechargeable lithium ion battery.
	Camera suddenly powers down.	<ol style="list-style-type: none"> 1) Auto Power Off activated (page 52). 2) The battery is dead. 	<ol style="list-style-type: none"> 1) Turn power back on. 2) Charge the battery (page 37).
Image Recording	Image is not recorded when the shutter button is pressed.	<ol style="list-style-type: none"> 1) The camera is in the PLAY mode. 2) Flash unit is being charged. 3) Memory is full. 	<ol style="list-style-type: none"> 1) Use the mode dial to select the currently selected recording mode (page 59). 2) Wait until the flash unit finishes charging. 3) Transfer files you want to keep to your computer and then delete files from image memory, or use a different memory card.
	Auto Focus does not focus properly.	<ol style="list-style-type: none"> 1) The lens is dirty. 2) The subject is not located in the center of the focus frame when you compose the image. 3) The subject you are shooting is a type that is not compatible with Auto Focus operation (page 65). 4) You are moving the camera. 	<ol style="list-style-type: none"> 1) Clean the lens. 2) Make sure the subject is centered in the focus frame when composing the image. 3) Use manual focus (page 86). 4) Mount the camera on a tripod.

APPENDIX

	Symptom	Possible Cause	Action
Image Recording	The subject is out of focus in the recorded image.	The image is not focused properly.	When composing the image, make sure the subject on which you want to focus is located inside the focus frame.
	The flash does not fire.	<ol style="list-style-type: none"> 1) “” (flash off) is selected as the flash mode. 2) The battery is dead. 3) The camera is in a movie mode (Movie Mode, Past Movie Mode, Short Movie Mode, MOVIE BEST SHOT Mode). 4) A scene that selects “” (flash off) as the flash mode is selected in the BEST SHOT mode. 	<ol style="list-style-type: none"> 1) Select a different flash mode (page 69). 2) Charge the battery (page 37). 3) Select a different recording mode (page 59). 4) Select a different flash mode (page 69) or BEST SHOT scene (page 100).
	Camera powers down during self-timer countdown.	The battery is dead.	Charge the battery (page 37).
	Monitor screen image is out of focus.	<ol style="list-style-type: none"> 1) You are using the Manual Focus mode and have not focused the image. 2) You are trying to use the Macro mode () when shooting a scenery or portrait shot. 3) You are trying to use Auto Focus or the Infinity mode () when shooting a close-up shot. 	<ol style="list-style-type: none"> 1) Focus the image (page 86). 2) Use Auto Focus for scenery and portrait shots. 3) Use the Macro mode () for close-ups.
	Recorded images are not saved in memory.	<ol style="list-style-type: none"> 1) Camera powers down before the save operation is complete. 2) Removing the memory card before the save operation is complete. 	<ol style="list-style-type: none"> 1) When the battery indicator shows “”, charge the battery as soon as possible (page 37). 2) Do not remove the memory card before the save operation is complete.

APPENDIX

	Symptom	Possible Cause	Action
Movies	Vertical lines on the monitor screen.	Recording a very brightly lit subject can cause a vertical band to appear in the monitor screen image.	This is a CCD phenomenon known as “vertical smear”, and does not indicate malfunction of the camera. Note that vertical smear is not recorded with the image in the case of a snapshot, but it is recorded in the case of a movie.
	Noise in audio.	Auto Focus, zoom, and aperture operation noise.	Change the focus to Manual Focus or Pan Focus, which will eliminate Auto Focus operation noise (pages 85, 86).
	Out of focus images.	<ol style="list-style-type: none"> 1) The subject is outside the shooting range of the camera. 2) Subject type is difficult to focus. 3) Subject is not compatible with Auto Focus. 	<ol style="list-style-type: none"> 1) Record within the allowable shooting range. 2) Try changing the focus mode to Manual Focus (page 86) or Pan Focus (page 85). 3) Try pointing the camera at another subject momentarily. This may correct the problem.
	Digital noise in images.	Sensitivity is increased automatically for dark subjects. Greater sensitivity increases the chance of digital noise.	Use a light or some other means to illuminate the subject.

APPENDIX

	Symptom	Possible Cause	Action
Playback	Color of the playback image is different from the image on the monitor screen during recording.	Sunlight or light from another source is shining directly into the lens during recording.	Position the camera so sunlight does not shine directly into the lens.
	Images are not displayed.	A memory card with non-DCF images recorded with another camera is loaded in the camera.	This camera cannot display non-DCF images recorded onto a memory card using another digital camera.
Other	All buttons and switches are disabled.	Circuit problem caused by electrostatic charge, impact, etc. while the camera was connected to another device.	Remove the battery from the camera, reinsert it, and then try again.
	Monitor screen is off.	USB communication is in progress.	After confirming that the computer is not accessing camera memory, disconnect the USB cable.
	Cannot transfer files over a USB connection.	<ol style="list-style-type: none"> 1) USB cable is not connected securely. 2) USB driver is not installed. 3) Camera is turned off. 	<ol style="list-style-type: none"> 1) Check all connections. 2) Install the USB driver on your computer (page 183). 3) Turn on the camera.

If you have problems installing the USB driver...

You may not be able to install the USB driver properly if you use the USB cable to connect the camera to a computer running Windows before installing the USB driver from the bundled CD-ROM, or if you have another type of driver installed. This will make it impossible for the computer to recognize the digital camera when it is connected. If this happens, you will need to re-install the camera's USB driver. For information about how to re-install the USB driver, see the USB driver's "Read me" file on the CD-ROM that comes bundled with the camera.

Display Messages

Battery is low.	The battery is dead.
Can not find the file.	The camera cannot find a image specified by the slideshow "Images" setting. Specify another image (page 144).
Cannot register any more files.	<ul style="list-style-type: none"> You are attempting to save a BEST SHOT scene when there are already 999 scenes in the "SCENE" folder, or a MOVIE BEST SHOT when there are already 999 scenes in the "MSCENE" folder.
Card ERROR	<p>Some problem occurred with the memory card. Turn off the camera, and remove and then reinsert the memory card. If the same message appears, format the memory card (page 169).</p> <p>»» IMPORTANT! ««</p> <p>Formatting the memory card deletes all files on the memory card. Before formatting, try transferring recoverable files to a computer or some other storage device.</p>
Check connections!	<ul style="list-style-type: none"> You are attempting to connect the camera to a printer while the camera's USB settings are not compatible with the USB system of the printer (page 177). You are attempting to connect to a computer that does not have a USB driver installed (page 183).

File could not be saved because battery is low.	The battery is dead, so the recorded image could not be saved.
Folder cannot be created.	This message appears when you try to record an image while there are 9,999 files stored in the 999th folder. If you want to record more files, delete files you no longer need (page 152).
LENS ERROR	There is something wrong with the lens module. Contact your retailer or a CASIO authorized service center.
Load paper!	The camera is in the Printer mode, and the printer is out of paper.
Memory Full	Memory is full. If you want to record more files, delete files you no longer need (page 152).
Printing Error	<p>One of the following problems occurred during printing.</p> <ul style="list-style-type: none"> Printer power off Printer internal error

APPENDIX

Record Error Image compression could not be performed during image data storage for some reason. Record the image again.

Replenish ink! The camera is in the Printer mode, and the printer is running low on ink or is out of ink.

SYSTEM ERROR Your camera system is corrupted. Contact your retailer or a CASIO service center.

The card is locked. The LOCK switch of the SD memory card is locked. You cannot store images to or delete images from a memory card that is locked.

There are no files. There are no files in built-in memory or on the memory card.

There are no printing images. There are no DPOF settings specifying images and the number of copies of each for printing.

Set up DPOF. Configure the required DPOF settings (page 175).

There is no image to register. The image or movie whose setup you are trying to save is not supported by BEST SHOT or MOVIE BEST SHOT.

This card is not formatted. The memory card loaded in the camera is not formatted. Format the memory card (page 169).

This file cannot be played. The image file or audio file is corrupted, or is a type that cannot be displayed by this camera.

This function cannot be used. You attempted to copy files from built-in memory to a memory card loaded in the camera while there is no memory card in the camera (page 170).

This function is not supported for this file. The function you are trying to perform is not supported for the file on which you are trying to perform it.

Specifications

Product Digital Camera

Model EX-P505

■ Camera Functions

Image Files Format

Snapshots JPEG (Exif Ver.2.2); DCF (Design rule for Camera File system) 1.0 standard; DPOF compliant

Movies AVI (MPEG-4)

Audio WAV

Recording Media 7.5MB built-in flash memory
SD Memory Card
MultimediaCard

Data Size

• Snapshots

File Size (pixels)	Quality	Approximate Image File Size	Built-in flash memory 7.5MB	SD Memory Card 256MB*
2560 × 1920	Fine	2.1MB	3 shots	116 shots
	Normal	1.7MB	3 shots	131 shots
	Economy	1.3MB	5 shots	178 shots
2560 × 1712 (3:2)	Fine	2.0MB	3 shots	118 shots
	Normal	1.6MB	4 shots	146 shots
	Economy	1.1MB	6 shots	207 shots
2048 × 1536	Fine	1.64MB	4 shots	143 shots
	Normal	1.23MB	5 shots	184 shots
	Economy	630KB	10 shots	356 shots
1600 × 1200 (UXGA)	Fine	1.05MB	6 shots	215 shots
	Normal	710KB	9 shots	319 shots
	Economy	370KB	18 shots	623 shots
1280 × 960 (SXGA)	Fine	680KB	10 shots	332 shots
	Normal	460KB	15 shots	509 shots
	Economy	250KB	28 shots	924 shots
640 × 480 (VGA)	Fine	190KB	36 shots	1188 shots
	Normal	140KB	47 shots	1559 shots
	Economy	90KB	75 shots	2495 shots

APPENDIX

• Movies

Image Size (Pixels)	Maximum Recording Time Per File	Approximate Data Rate (Frame Rate)	Approximate Recording Time for Built-in Flash Memory 7.5 MB	Approximate Recording Time for SD Memory Card 256MB
HQ 640 × 480	Until memory full	4.2 megabits per second (30 frames / second)	14 seconds	8 minutes and 10 seconds
Normal 640 × 480	Until memory full	2.2 megabits per second (30 frames / second)	28 seconds	15 minutes and 34 seconds
LP 320 × 240	Until memory full	790 kilobits per second (15 frames / second)	77 seconds	42 minutes and 46 seconds

* Based on Matsushita Electric Industrial Co., Ltd. products.
Capacity depends on card manufacturer.

* To determine the number of images that can be stored on a memory card of a different capacity, multiply the capacities in the table by the appropriate value.

Delete Single-file, all files (with protection)

Effective Pixels 5.0 million

Imaging Element 1/2.5-inch square pixel color CCD
(Total pixels: 5.25 million)

Lens/Focal Distance

Lenses F3.3 (W) to 3.6 (T); f=6.3 (W) to 31.5mm (T) (equivalent to approximately 38 (W) to 190mm (T) for 35mm film)
10 lenses in 8 groups, with aspherical lens

Zoom 5X optical zoom; 8X digital zoom (40X in combination with optical zoom)

Focusing Contrast Detection Auto Focus
Focus Modes: Auto Focus, Macro mode, Infinity mode, manual focus
AF Area: spot, Pan Focus (movies only), multi, free

APPENDIX

Approximate Focus Range (from lens surface)

Auto Focus	Snapshots: 40 cm to ∞ (1.3' to ∞) Movies: 10cm to ∞ (0.3' to ∞)
Macro	1 cm to 50 cm (0.4" to 19.7")
Infinity Mode	∞
Manual	1 cm to ∞ (0.4" to ∞) • Using optical zoom causes the above ranges to change.

Exposure Control

Light Metering	Multi-pattern, center-weighted, spot by CCD
Exposure	Program AE
Exposure Compensation	-2EV to +2EV (1/3EV units)

Shutter	CCD electronic shutter; mechanical shutter Snapshot Mode (Auto) / Aperture Priority AE: 1/8 to 1/2000 second Shutter Speed Priority AE / Manual Exposure: 60 to 1/2000 second • Above shutter speeds do not apply when using a BEST SHOT scene.
----------------------	--

Aperture	F3.3, 3.7, 4.4, 5.2, 6.2, 7.4 • Using optical zoom causes the aperture to change.
-----------------------	--

White Balance	Automatic, fixed (7 modes), manual switching
----------------------------	--

Sensitivity	Snapshots: Auto, ISO 50, ISO 100, ISO 200, ISO 400 Movies: Auto (ISO100 to ISO1600 equivalent)
--------------------------	---

Self-timer	10 seconds, 2 seconds, Triple Self-timer
-------------------------	--

Built-in Flash

Flash Modes	AUTO, ON, OFF, Red eye reduction
Flash Range	0.4 to 3.0 meters (1.3' to 9.8') (ISO Sensitivity: "Auto") * Depends on zoom factor.

Recording Functions	Snapshot; audio snapshot; macro; self-timer; BEST SHOT; movie with audio (Movie, Past Movie, Short Movie, MOVIE BEST SHOT) • Movie audio is stereo. Other audio is monaural.
----------------------------------	---

APPENDIX

Audio Recording Time

- Audio Snapshot Approximately 30 seconds maximum per image
- After Recording Approximately 30 seconds maximum per image

Monitor Screen 2.0-inch TFT color LCD
84,960 pixels (354 × 240)

Viewfinder Monitor screen

Timekeeping Functions Built-in digital quartz clock

Date and Time Recorded with image data

Auto Calendar To 2049

World Time City; Date; Time; Summer time;
162 cities in 32 time zones

Input/Output Terminals AC adaptor connector (DC IN 4.5V);
USB / AV port (NTSC/PAL, stereo audio)

USB USB 2.0 Hi-Speed compatible

Microphones Stereo

Speaker Monaural

■ Power Requirements

Power Requirements Rechargeable lithium ion battery
(NP-40) × 1

Approximate Battery Life:

The values below indicate the amount of time under the conditions defined below, until power automatically turns off due to battery failure. They do not guarantee that you will be able to achieve this level of operation. Low temperatures shorten battery life.

Operation	Approximate Battery Life
Number of Shots (CIPA Standard)*1 (Operating Time)	220 shots (110 minutes)
Number of Shots, Continuous Recording*2 (Operating Time)	550 shots (110 minutes)
Continuous Snapshot Playback*3	200 minutes
Continuous Movie Recording*4	120 minutes

Supported Battery: NP-40 (Rated Capacitance: 1230mAh)
Storage Medium: SD Memory Card

*1 Number of Shots (CIPA Standard)

- Temperature: 23°C (73°F)
- Monitor Screen: On
- Zoom operation between full wide to full telephoto every 30 seconds, during which two images are recorded, one image with flash; power turned off and back on every time 10 images are recorded.

APPENDIX

*2 Continuous Recording Conditions

- Temperature: 23°C (73°F)
- Monitor screen: On
- Flash: Off
- Image recorded every 12 seconds, alternating full wide-angle and full telephoto zoom

*3 Continuous Snapshot Playback Conditions

- Temperature: 23°C (73°F)
- Scroll one image about every 10 seconds

*4 Approximate time for continuous movie recording, without using zoom.

Power Consumption 4.5V DC Approximately 4.6W

Dimensions 98.5(W) × 55.5(H) × 73.5(D) mm
(3.9"(W) × 2.2"(H) × 2.9"(D))
(excluding projections)

Weight Approximately 215 g (7.6 oz)
(excluding battery and accessories)

Bundled Accessories Rechargeable lithium ion battery (NP-40); Rapid charger (BC-30L); AC power cord; USB cable; AV cable; Strap; Lens cap; Cap holder; Lens hood; CD-ROMs (2); Basic Reference

■ Rechargeable Lithium Ion Battery (NP-40)

Rated Voltage 3.7 V

Rated Capacitance 1230 mAh

Operating Temperature

Range 0°C to 40°C (32°F to 104°F)

Dimensions 38.5(W) × 38.0(H) × 9.3(D) mm
(1.5"(W) × 1.5"(H) × 0.37"(D))

Weight Approximately 34 g (1.20 oz)

■ Rapid Charger (BC-30L) : Power Cord Type

Power Requirement 100 to 240V AC, 0.13A, 50/60Hz

Output 4.2V DC, 900 mA

Charging Temperature 5°C to 35°C (41°F to 95°F)

Chargeable Battery type ... Rechargeable lithium ion battery (NP-40)

Full Charge Times Approximately 2 hours

Dimensions 80 (W) × 55 (H) × 30 (D) mm
(3.1"(W) × 2.2"(H) × 1.2"(D))
(excluding projections)

Weight Approximately 60 g (2.1 oz)

■ **Rapid Charger (BC-30L) : Plug-in Type**

Power Requirement 100 to 240V AC, 0.13A, 50/60Hz

Output 4.2V DC, 900 mA

Charging Temperature 5°C to 35°C (41°F to 95°F)

Chargeable Battery type ... Rechargeable lithium ion battery (NP-40)

Full Charge Times Approximately 2 hours

Dimensions 80 (W) × 55 (H) × 25 (D) mm
(3.1"(W) × 2.2"(H) × 0.98"(D))
(excluding projections)

Weight Approximately 63 g (2.2 oz)