

# FUJIFILM

BL00829-201 **E**

## DIGITAL CAMERA FINEPIX F200 EXR

### Owner's Manual

Thank you for your purchase of this product. This manual describes how to use your FUJIFILM FinePix F200EXR digital camera and the supplied software. Be sure that you have read and understood its contents before using the camera.

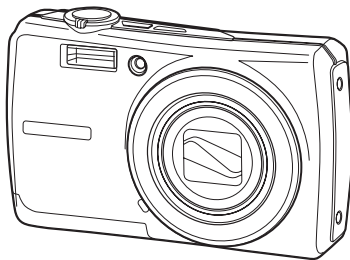

For information on related products, visit our website at <http://www.fujifilm.com/products/index.html>

Exif Print

SD  
HG

xD  
xD-Picture Card™

PictBridge



SUPER  
CCD EXR

Before You Begin

First Steps

Basic Photography and Playback

More on Photography

More on Playback

Movies

Connections

Menus

Technical Notes

Troubleshooting

Appendix

## IMPORTANT SAFETY INSTRUCTIONS

- **Read Instructions:** All the safety and operating instructions should be read before the appliance is operated.
- **Retain Instructions:** The safety and operating instructions should be retained for future reference.
- **Heed Warnings:** All warnings on the appliance and in the operating instructions should be adhered to.
- **Follow Instructions:** All operating and use instructions should be followed.

### Installation

**Power Sources:** This video product should be operated only from the type of power source indicated on the marking label. If you are not sure of the type of power supply to your home, consult your appliance dealer or local power company. For video products intended to operate from battery power, or other sources, refer to the operating instructions.

**Grounding or Polarization:** This video product is equipped with a polarized alternating-current line plug (a plug having one blade wider than the other). This plug will fit into the power outlet only one way. This is a safety feature. If you are unable to insert the plug fully into the outlet, try reversing the plug. If the plug should still fail to fit, contact your electrician to replace your obsolete outlet. Do not defeat the safety purpose of the polarized plug.

**Alternate Warnings:** This video product is equipped with a three-wire grounding-type plug, a plug having a third (grounding) pin. This plug will only fit into a grounding-type power outlet. This is a safety feature. If you are unable to insert the plug into the outlet, contact your electrician to replace your obsolete outlet. Do not defeat the safety purpose of the grounding type plug.

**Overloading:** Do not overload wall outlets and extension cords as this can result in a risk of fire or electric shock.

**Ventilation:** Slots and openings in the cabinet are provided for ventilation, to ensure reliable operation of the video product and to protect it from overheating, and these openings must not be blocked or covered. The openings should never be blocked by placing the video product on a bed, sofa, rug, or other similar surface.

This video product should not be placed in a built-in installation such as a bookcase or rack unless proper ventilation is provided or the manufacturer's instructions have been adhered to. This video product should never be placed near or over a radiator or heat register.

**Attachments:** Do not use attachments not recommended by the video product manufacturer as they may cause hazards.

**Water and Moisture:** Do not use this video product near water—for example, near a bath tub, wash bowl, kitchen sink, or laundry tub, in a wet basement, or near a swimming pool, and the like.

**Power-Cord Protection:** Power-supply cords should be routed so that they are not likely to be walked on or pinched by items placed upon or against them, paying particular attention to cords at plugs, convenience receptacles, and the point where they exit from the appliance.

**Accessories:** Do not place this video product on an unstable cart, stand, tripod, bracket, or table. The video product may fall, causing serious injury to a child or adult, and serious damage to the appliance. Use only with a cart, stand, tripod, bracket, or table recommended by the manufacturer, or sold with the video product. Any mounting of the appliance should follow the manufacturer's instructions, and should use a mounting accessory recommended by the manufacturer.

An appliance and cart combination should be moved with care. Quick stops, excessive force, and uneven surfaces may cause the appliance and cart combination to overturn.

### Antennas

**Outdoor Antenna Grounding:** If an outside antenna or cable system is connected to the video product, be sure the antenna or cable system is grounded so as to provide some protection against voltage surges and built-up static charges. Section 810 of the National Electrical Code, ANSI/NFPA No. 70, provides information with respect to proper grounding of the mast and supporting structure, grounding of the lead-in wire to an antenna discharge unit, size of grounding conductors, location of antenna discharge unit, connection to grounding electrodes, and requirements for the grounding electrode.

EXAMPLE OF ANTENNA GROUNDING AS PER NATIONAL ELECTRICAL CODE

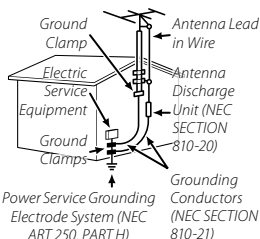

**Power Lines:** An outside antenna system should not be located in the vicinity of overhead power lines or other electric light or power circuits,

or where it can fall into such power lines or circuits. When installing an outside antenna system, extreme care should be taken to keep from touching such power lines or circuits as contact with them might be fatal.

#### Use

**Cleaning:** Unplug this video product from the wall outlet before cleaning. Do not use liquid cleaners or aerosol cleaners. Use a damp cloth for cleaning.

**Object and Liquid Entry:** Never push objects of any kind into this video product through openings as they may touch dangerous voltage points or short out parts that could result in a fire or electric shock. Never spill liquid of any kind on the video product.

**Lightning:** For added protection for this video product receiver during a lightning storm, or when it is left unattended and unused for long periods of time, unplug it from the wall outlet and disconnect the antenna or cable system. This will prevent damage to the video product due to lightning and power-line surges.

#### Service

**Service:** Do not attempt to service this video product yourself as opening or removing covers may expose you to dangerous voltage or other hazards. Refer all servicing to qualified service personnel.

**Damage Requiring Service:** Unplug this video product from the wall outlet

and refer servicing to qualified service personnel under the following conditions:

- When the power-supply cord or plug is damaged.
- If liquid has been spilled, or objects have fallen into the video product.
- If the video product has been exposed to rain or water.
- If the video product has been dropped or the cabinet has been damaged.

If the video product does not operate normally follow the operating instructions. Adjust only those controls that are covered by the operating instructions as an improper adjustment of other controls may result in damage and will often require extensive work by a qualified technician to restore the video product to its normal operation.

When the video product exhibits a distinct change in performance—this indicates a need for service.

**Replacement Parts:** When replacement parts are required, be sure the service technician has used replacement parts specified by the manufacturer or have the same characteristics as the original part. Unauthorized substitutions may result in fire, electric shock or other hazards.

**Safety Check:** Upon completion of any service or repairs to this video product, ask the service technician to perform safety checks to determine that the video product is in proper operating condition.



## Be sure to read these notes before use

### Safety Notes



- Make sure that you use your camera correctly. Read these safety notes and your *Owner's Manual* carefully before use.
- After reading these safety notes, store them in a safe place.

### About the Icons

The icons shown below are used in this document to indicate the severity of the injury or damage that can result if the information indicated by the icon is ignored and the product is used incorrectly as a result.

	<b>WARNING</b>	This icon indicates that death or serious injury can result if the information is ignored.
	<b>CAUTION</b>	This icon indicates that personal injury or material damage can result if the information is ignored.

The icons shown below are used to indicate the nature of the instructions which are to be observed.

	Triangular icons tell you that this information requires attention ("Important").
	Circular icons with a diagonal bar tell you that the action indicated is prohibited ("Prohibited").
	Filled circles with an exclamation mark indicate an action that must be performed ("Required").

### WARNING



Unplug from power socket

**If a problem arises, turn the camera off, remove the battery, and disconnect and unplug the AC power adapter.** Continued use of the camera when it is emitting smoke, is emitting any unusual odor, or is in any other abnormal state can cause a fire or electric shock. Contact your FUJIFILM dealer.



**Do not allow water or foreign objects to enter the camera.** If water or foreign objects get inside the camera, turn the camera off, remove the battery, and disconnect and unplug the AC power adapter. Continued use of the camera can cause a fire or electric shock. Contact your FUJIFILM dealer.

 **WARNING**

Do not use in the bathroom or shower

**Do not use the camera in the bathroom or shower.** This can cause a fire or electric shock.



Do not disassemble

**Never attempt to change or take apart the camera. (Never open the casing.) Do not use the camera when it has been dropped or the casing is damaged.** This can cause a fire or electric shock. Contact your FUJIFILM dealer.



**Do not change, heat or unduly twist or pull the connection cord and do not place heavy objects on the connection cord.** These actions could damage the cord and cause a fire or electric shock. If the cord is damaged, contact your FUJIFILM dealer.



**Do not place the camera on an unstable surface.** This can cause the camera to fall or tip over and cause injury.



**Never attempt to take pictures while in motion.** Do not use the camera while you are walking or driving a vehicle. This can result in you falling down or being involved in a traffic accident.



**Do not touch any metal parts of the camera during a thunderstorm.** This can cause an electric shock due to induced current from the lightning discharge.



**Do not use the battery except as specified.** Load the battery as shown by the indicator.



**Do not heat, change or take apart the battery. Do not drop or subject the battery to impacts. Do not store the battery with metallic products.** Any of these actions can cause the battery to burst or leak and cause fire or injury as a result.



**Use only the battery or AC power adapters specified for use with this camera. Do not use voltages other than the power supply voltage shown.** The use of other power sources can cause a fire.



**If the battery leaks and fluid gets in contact with your eyes, skin or clothing, flush the affected area with clean water and seek medical attention or call an emergency number right away.**



**Do not use the charger to charge batteries other than those specified here.** The supplied battery charger is for use only with the type of battery supplied with the camera. Using the charger to charge conventional batteries or other types of rechargeable batteries can cause the battery to leak fluid, overheat or burst.



**When carrying the battery, install it in a digital camera or keep it in the hard case. When storing the battery, keep it in the hard case. When discarding, cover the battery terminals with insulation tape.** Contact with other metallic objects or batteries could cause the battery to ignite or burst.



**Keep memory cards out of the reach of small children.** Because memory cards are small, they can be swallowed by children. Be sure to store memory cards out of the reach of small children. If a child swallows a memory card, seek medical attention or call an emergency number.

 **CAUTION**

**Do not use this camera in locations affected by oil fumes, steam, humidity or dust.** This can cause a fire or electric shock.



**Do not leave this camera in places subject to extremely high temperatures.** Do not leave the camera in locations such as a sealed vehicle or in direct sunlight. This can cause a fire.



**Keep out of the reach of small children.** This product could cause injury in the hands of a child.



**Do not place heavy objects on the camera.** This can cause the heavy object to tip over or fall and cause injury.



**Do not move the camera while the AC power adapter is still connected. Do not pull on the connection cord to disconnect the AC power adapter.** This can damage the power cord or cables and cause a fire or electric shock.



**Do not cover or wrap the camera or the AC power adapter in a cloth or blanket.** This can cause heat to build up and distort the casing or cause a fire.



**When you are cleaning the camera or you do not plan to use the camera for an extended period, remove the battery and disconnect and unplug the AC power adapter.** Failure to do so can cause a fire or electric shock.



**When charging ends, unplug the charger from the power socket.** Leaving the charger plugged into the power socket can cause a fire.



**Using a flash too close to a person's eyes may temporarily affect the eyesight.** Take particular care when photographing infants and young children.



**When a memory card is removed, the card could come out of the slot too quickly. Use your finger to hold it and gently release the card.**



**Request regular internal testing and cleaning for your camera.** Build-up of dust in your camera can cause a fire or electric shock. Contact your FUJIFILM dealer to request internal cleaning every two years. Please note that this service is not free of charge.

### The Battery and Power Supply

The following describes the proper use of the battery and how to prolong its life. Incorrect use can shorten battery life or cause leakage, overheating, fire, or explosion.

The battery is not charged at shipment. Charge the battery before use. Keep the battery in its case when not in use.

#### Notes on the Battery

The battery gradually loses its charge when not in use. Charge the battery one or two days before use.

Battery life can be extended by turning the camera off when not in use.

Battery capacity decreases at low temperatures; a depleted battery may not function at when cold. Keep a fully charged spare battery in a warm place and exchange as necessary, or keep the battery in your pocket or other warm place and insert it in the camera only when shooting. Do not place the battery in direct contact with hand warmers or other heating devices.

#### Charging the Battery

Charge the battery in the supplied battery charger (pg. 5). Charging times will increase at ambient temperatures below +10°C (+50°F) or above +35°C (+95°F). Do not attempt to charge the battery at temperatures above 40°C (+104°F); at temperatures below 0°C (+32°F), the battery will not charge.

Do not attempt to recharge a fully charged battery. The battery does

not however need to be fully discharged before charging.

The battery may be warm to the touch immediately after charging or use. This is normal.

#### Battery Life

At normal temperatures, the battery can be recharged about 300 times. A noticeable decrease in the length of time the battery will hold a charge indicates that it has reached the end of its service life and should be replaced.

#### Storage

Performance may be impaired if the battery is left unused for extended periods when fully charged. Run the battery flat before storing it.

If the camera will not be used for an extended period, remove the battery and store it in a dry place with an ambient temperature of from +15°C to +25°C (+59°F to +77°F). Do not store in locations exposed to extremes of temperature.

#### Cautions: Handling the Battery

- Do not transport or store with metal objects such as necklaces or hairpins.
- Do not expose to flame or heat.
- Do not disassemble or modify.
- Use with designated chargers only.
- Dispose of used batteries promptly.
- Do not drop or subject to strong physical shocks.
- Do not expose to water.
- Keep the terminals clean.

- The battery and camera body may become warm to the touch after extended use. This is normal.

#### AC Adapters (Available Separately)

- Use only FUJIFILM AC adapters designated for use with this camera. Other adapters could damage the camera.
- The AC adapter is for indoor use only.
  - Be sure the DC plug is securely connected to the camera.
  - Turn the camera off before disconnecting the adapter. Disconnect the adapter by the plug, not the cable.
  - Do not use with other devices.
  - Do not disassemble.
  - Do not expose to high heat and humidity.
  - Do not subject to strong physical shocks.
  - The AC adapter may hum or become hot to the touch during use. This is normal.
  - If the AC adapter causes radio interference, reorient or relocate the receiving antenna.

### Using the Camera

To ensure that images are recorded correctly, do not subject the camera to impact or physical shocks while images are being recorded.

#### Electrical Interference

This camera may interfere with hospital or aviation equipment. Consult with hospital or airline staff before using the camera in a hospital or on an aircraft.

#### Liquid Crystal

In the event that the monitor is damaged, care should be taken to avoid contact with liquid crystal. Take the urgent action indicated should any of the following situations arise:

- **If liquid crystal comes in contact with your skin**, clean the area with a cloth and then wash thoroughly with soap and running water.
- **If liquid crystal enters your eyes**, flush the affected eye with clean water for at least 15 minutes and then seek medical assistance.
- **If liquid crystal is swallowed**, rinse your mouth thoroughly with water. Drink large quantities of water and induce vomiting, then seek medical assistance.

#### Take Test Shots

Before taking photographs on important occasions (such as at weddings or before taking the camera on a trip), take a test shot and view the result in the monitor to ensure that the camera is functioning normally. FUJIFILM Corporation can not accept liability for damages or lost profits incurred as a result of product malfunction.

## NOTICES

To prevent fire or shock hazard, do not expose the unit to rain or moisture.

Please read the "Safety Notes" (pages iii–v) and make sure you understand them before using the camera.

Perchlorate Material—special handling may apply. See <http://www.dtscc.gov/hazardouswaste/perchlorate>.

### For Customers in the U.S.A.

Tested To Comply With FCC Standards  
FOR HOME OR OFFICE USE

### FCC Statement

This device complies with Part 15 of the FCC Rules. Operation is subject to the following two conditions: (1) This device may not cause harmful interference, and (2) this device must accept any interference received, including interference that may cause undesired operation.

### CAUTION

This equipment has been tested and found to comply with the limits for a Class B digital device, pursuant to Part 15 of the FCC Rules. These limits are designed to provide reasonable protection against harmful interference in a residential installation. This equipment generates, uses, and can radiate radio frequency energy and, if not installed and used in accordance with the instructions, may cause harmful interference to radio communications. However, there is no guarantee that interference will not occur in a particular installation. If this equipment does cause harmful interference to radio or television reception, which can be determined by turning the equipment off and on, the user is encouraged to try to correct the interference by one or more of the following measures:

- Reorient or relocate the receiving antenna.
- Increase the separation between the equipment and receiver.
- Connect the equipment into an outlet on a circuit different from that to which the receiver is connected.
- Consult the dealer or an experienced radio/TV technician for help.

You are cautioned that any changes or modifications not expressly approved in this manual could void the user's authority to operate the equipment.

### Notes on the Grant

To comply with Part 15 of the FCC Rules, this product must be used with a FUJIFILM-specified ferrite-core A/V cable, USB cable, and DC supply cord.

### For Customers in Canada

**CAUTION:** This Class B digital apparatus complies with Canadian ICES-003.

### EC Declaration of Conformity

We

**Name:** FUJIFILM Electronic Imaging Europe GmbH  
**Address:** Benzstrasse 2  
47533 Kleve, Germany

declare that the product

**Product Name:** FUJIFILM DIGITAL CAMERA FinePix F200EXR  
**Manufacturer's Name:** FUJIFILM Corporation  
**Manufacturer's Address:** 7-3, AKASAKA 9-CHOME, MINATO-KU,  
TOKYO 107-0052 JAPAN

conforms to the following Standards:

**Safety:** EN60065: 2002 + A1: 2006  
**EMC:** EN55022: 1998 + A1: 2000 + A2: 2003 Class B  
EN55024: 1998 + A1: 2001 + A2: 2003  
EN61000-3-2: 2000 + A2: 2005  
EN61000-3-3: 1995 + A1: 2001 + A2: 2005

following the provision of the EMC Directive (2004/108/EC)  
and Low Voltage Directive (2006/95/EC).



Kleve, Germany      February 1, 2009

Place

Date

Signature, Managing Director

**Disposal of Electrical and Electronic Equipment in Private Households****Disposal of Used Electrical and Electronic Equipment (Applicable in the European Union, Norway, Iceland and Liechtenstein)**

This symbol on the product, or in the manual and in the warranty, and/or on its packaging indicates that this product shall not be treated as household waste.

Instead it should be taken to an applicable collection point for the recycling of electrical and electronic equipment.



By ensuring this product is disposed of correctly, you will help prevent potential negative consequences to the environment and human health, which could otherwise be caused by inappropriate waste handling of this product.



This symbol on the batteries or accumulators indicates that those batteries shall not be treated as household waste.

If your equipment contains easy removable batteries or accumulators please dispose these separately according to your local requirements.

The recycling of materials will help to conserve natural resources. For more detailed information about recycling this product, please contact your local city office, your household waste disposal service or the shop where you purchased the product.

**In Countries Outside the European Union, Norway, Iceland and Liechtenstein**

If you wish to discard this product, including the batteries or accumulators, please contact your local authorities and ask for the correct way of disposal.

**Notes on Copyright**

Unless intended solely for personal use, images recorded using your digital camera system cannot be used in ways that infringe copyright laws without the consent of the owner. Note that some restrictions apply to the photographing of stage performances, entertainments, and exhibits, even when intended purely for personal use. Users are also asked to note that the transfer of memory cards containing images or data protected under copyright laws is only permissible within the restrictions imposed by those copyright laws.

**Trademark Information**

*xD-Picture Card* is a trademark of FUJIFILM Corporation. Macintosh, QuickTime, and Mac OS are trademarks of Apple Inc. in the U.S.A. and other countries. Microsoft, Windows, the Windows logo, Windows Vista and the Windows Vista logo are trademarks or registered trademarks of Microsoft Corporation in the United States and/or other countries. "Windows" is an abbreviation used in reference to the Microsoft Windows operating system. Adobe and Adobe Reader are either trademarks or registered trademarks of Adobe Systems Incorporated in the U.S.A. and/or other countries. The SDHC logo is a trademark.

**Note:** The "Designed for Microsoft® Windows® XP" and "CERTIFIED FOR Windows Vista™" logos apply only to the camera and camera hardware driver.

# About This Manual

Before using the camera, read this manual and the warnings on pages ii–vii. For information on specific topics, consult the sources below.

## ✓ **Camera Q & A** .....pg. ix

Know what you want to do but don't know the name for it? Find the answer in "Camera Q & A."

## ✓ **Troubleshooting** .....pg. 94

Having a specific problem with the camera? Find the answer here.

## ✓ **Glossary** .....pg. 105

The meanings of some technical terms may be found here.

## ✓ **Table of Contents** .....pg. xii

The "Table of Contents" gives an overview of the entire manual. The principal camera operations are listed here.

## ✓ **Warning Messages and Displays** .....pg. 101

Find out what's behind that flashing icon or error message in the monitor or electronic viewfinder.

## **Memory Cards**

Pictures can be stored in the camera's internal memory or on optional *xD-Picture Cards* and SD and SDHC memory cards. In this manual, both *xD-Picture Cards* and SD memory cards are referred to as "memory cards." For more information, see page 10.



## Camera Q & A

Find items by task.





### Camera Setup

Question	Key phrase	See page
How do I set the camera clock?	Date and time	12
Can I set the clock to local time when I travel?	Time difference	89
How do I keep the display from turning off automatically?	Auto power off	88
How do I make the display brighter or darker?	LCD brightness	87
How do I stop the camera beeping and clicking?	Operation and shutter volume	84
	Silent mode	17
Can I change the sound the shutter makes?	Shutter sound	84
What are the parts of the camera called?	Parts of the camera	2
What do the icons in the display mean?	Displays	3
How do I use the menus?	Menus	60
What's behind that flashing icon or error message?	Messages and displays	101
How much charge is left in the battery?	Battery level	14

### Sharing Pictures

Question	Key phrase	See page
Can I print pictures on my home printer?	Printing pictures	49
Can I copy my pictures to my computer?	Viewing pictures on a computer	54

## Taking Pictures

Question	Key phrase	See page
How many pictures can I take?	Memory capacity	106
Is there a quick and easy way to take snapshots?	 mode	14
How can I avoid blurred pictures?	Dual IS mode	16
How can I make good portraits?	Intelligent Face Detection	20
Can I choose my own settings for different scenes?	Scene position	35
Can the camera automatically adjust settings for different scenes?	 mode	33
Can I choose between clarity, reduced noise, and dynamic range?	 ,  , and  modes	32
How do I shoot close-ups?	Close-ups (macro mode)	27
How do I keep the flash from firing?	Flash mode	28
How do I stop my subjects' eyes glowing red when I use the flash?		
How do I "fill-in" shadows on back-lit subjects?		
How do I take a series of pictures in a single burst?	Continuous shooting mode	68
How do I turn off the lamp on the front of the camera?	AF-assist illuminator	24
How do I take a group portrait that includes the photographer?	Self-timer mode	30
How do I frame pictures with the subject off to one side?	Focus lock	22
Can I choose shutter speed and aperture?	<b>P</b> and <b>M</b> modes	37, 38
How do I adjust exposure?	Exposure compensation	25
How do I simulate the effects of different types of film?	Film simulation	65
How do I shoot movies?	Recording movies	45

## Viewing Pictures

Question	Key phrase	See page
How do I view my pictures?	Single-frame playback	40
How do I delete the current picture?	The  button	19
Can I select other pictures for deletion?	Deleting pictures	43
Can I zoom in on pictures during playback?	Playback zoom	41
How do I view a lot of pictures at once?	Multi-frame playback	42
How do I view all pictures taken on the same day?	Sort by date	42
Can I protect my pictures from accidental deletion?	Protect	77
Can I hide the icons in the display when viewing my pictures?	Choosing a display format	40
Can I view my pictures in a slide show?	Slide show	73
Can I add a short voice memo to my pictures?	Voice memo	80
Can I crop unwanted elements out of my pictures?	Crop (trimming)	81
Can I make small copies of pictures?	Resize	82
Can I copy pictures from internal memory to a memory card?	Copy	78
How do I view my pictures on TV?	Viewing pictures on TV	48
How do I view pictures on a High Definition device?	Component cable (sold separately)	48, 92

# Table of Contents

For Your Safety .....	ii
IMPORTANT SAFETY INSTRUCTIONS .....	ii
Safety Notes .....	iii
NOTICES .....	vi
About This Manual .....	viii
Camera Q & A .....	ix

## Before You Begin

Introduction .....	1
Symbols and Conventions .....	1
Supplied Accessories .....	1
Parts of the Camera .....	2
Camera Displays .....	3
The Mode Dial .....	4













## First Steps

Charging the Battery .....	5
Inserting the Battery .....	6
Inserting a Memory Card .....	8
Turning the Camera on and Off .....	11
Shooting Mode .....	11
Playback Mode .....	11
Basic Setup .....	12

## Basic Photography and Playback

Taking Pictures in  (Auto) Mode .....	14
Viewing Pictures .....	19

## More on Photography

 Intelligent Face Detection and Red-Eye Removal ...	20
Focus Lock .....	22
 Exposure Compensation .....	25
 Macro Mode (Close-ups) .....	27
 Using the Flash (Intelligent Flash) .....	28
 Using the Self-Timer .....	30
Shooting Mode .....	32
 AUTO .....	32
 EXR .....	32
 NATURAL &  .....	34
 NATURAL LIGHT .....	35
 SCENE POSITION .....	35
 MANUAL .....	37
 PROGRAM AE/A APERTURE PRIORITY AE .....	38

**More on Playback**

Playback Options.....	40
Playback Zoom.....	41
Multi-Frame Playback.....	42
Sort by Date.....	42
 Deleting Pictures.....	43



















**Movies**









 Recording Movies.....	45
 Viewing Movies.....	47

**Connections**

Viewing Pictures on TV.....	48
Printing Pictures via USB.....	49
Connecting the Camera.....	49
Printing Selected Pictures.....	49
Printing the DPOF Print Order.....	51
Creating a DPOF Print Order.....	52
Viewing Pictures on a Computer.....	54
Installing FinePixViewer.....	54
Connecting the Camera.....	58

**Menus**

Using the Menu: Shooting Mode.....	60
Using the <i>F</i> -Mode Menu.....	60
<i>F</i> -Mode Menu Options.....	61
 ISO.....	62
 DYNAMIC RANGE.....	62
 IMAGE SIZE.....	63
 IMAGE QUALITY.....	64
 WHITE BALANCE.....	64
 FILM SIMULATION.....	65
Using the Shooting Menu.....	66
Shooting Menu Options.....	67
 CONTINUOUS.....	68
 PHOTOMETRY.....	69
 AF MODE.....	70
 POWER MANAGEMENT.....	71
Using the Menu: Playback Mode.....	72
Using the <i>F</i> -Mode Menu.....	72
<i>F</i> -Mode Menu Options.....	72
 SLIDE SHOW.....	73
 DISP ASPECT.....	73
Using the Playback Menu.....	74
Playback Menu Options.....	75
 RED EYE REMOVAL.....	75
 IMAGE ROTATE.....	76
 PROTECT.....	77
 COPY.....	78
 VOICE MEMO.....	80
 TRIMMING.....	81
 RESIZE.....	82

<b>The Setup Menu</b> .....	83
Using the Setup Menu .....	83
Setup Menu Options.....	84
 IMAGE DISP. ....	85
 FRAME NO. ....	86
 DIGITAL ZOOM .....	87
 PLAYBACK VOLUME.....	87
 LCD BRIGHTNESS.....	87
 FORMAT.....	88
 AUTO POWER OFF .....	88
 TIME DIFFERENCE .....	89
<b>Technical Notes</b>	
<b>Optional Accessories</b> .....	90
Accessories from FUJIFILM .....	91
<b>Caring for the Camera</b> .....	93
<b>Troubleshooting</b>	
<b>Troubleshooting</b> .....	94
<b>Warning Messages and Displays</b> .....	101
<b>Appendix</b>	
<b>Glossary</b> .....	105
<b>Internal Memory/Memory Card Capacity</b> .....	106
<b>Specifications</b> .....	108
<b>FUJIFILM Digital Camera Worldwide Network</b> .....	114

# Introduction

## ***Symbols and Conventions***

The following symbols are used in this manual:

 **Caution:** This information should be read before use to ensure correct operation.

 **Note:** Points to note when using the camera.

 **Tip:** Additional information that may be helpful when using the camera.

Menus and other text in the camera monitor are shown in bold. In the illustrations in this manual, the monitor display may be simplified for explanatory purposes.

## ***Supplied Accessories***

The following items are included with the camera:

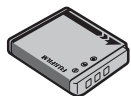

NP-50 rechargeable  
battery

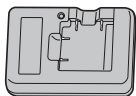

BC-45W battery charger

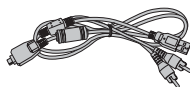

USB-A/V cable



FinePix software CD  
**(IMPORTANT: read license  
agreement on the last  
page of this manual  
before opening)**

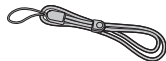

Strap

### **Attaching the Strap**

Attach the strap as shown.

1

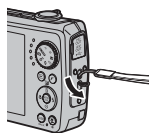

2

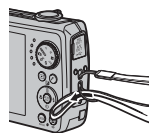

Owner's Manual  
(this manual)

## Parts of the Camera

For more information, refer to the page listed to the right of each item.

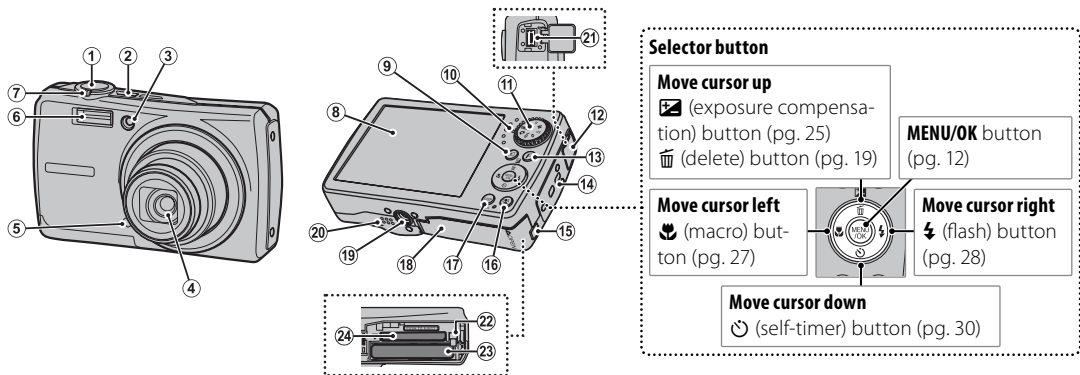

1	Shutter button.....	18	9	[playback] button .....	40	17	<b>DISP</b> (display)/ <b>BACK</b> button .....	16, 40
2	<b>ON/OFF</b> button .....	11	10	Indicator lamp.....	18	18	Battery-chamber cover.....	6
3	AF-assist illuminator.....	24	11	Mode dial.....	4	19	Tripod mount	
	Self-timer lamp.....	31	12	Terminal cover.....	49	20	Speaker .....	81
4	Lens and lens cover		13	<b>F</b> (photo mode) button.....	60	21	Connector for USB, A/V, and High Definition (HD) devices.....	48
5	Microphone.....	80	14	Strap eyelet.....	1	22	Battery latch.....	6, 7
6	Flash.....	28	15	DC coupler cable cover.....	91	23	Battery chamber.....	6
7	Zoom control.....	15, 41	16	[Intelligent Face Detection]/		24	Memory card slot.....	9
8	Monitor.....	3		[red-eye removal] button.....	20			



## Camera Displays

The following indicators may appear during shooting and playback: The indicators displayed vary with camera settings.

### Shooting

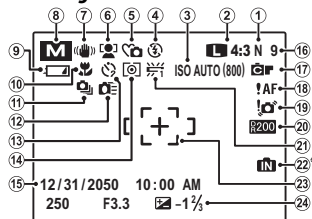

\* : indicates that no memory card is inserted and that pictures will be stored in the camera's internal memory (pg. 8).

1	Image quality.....	64	13	Self-timer indicator .....	30
2	Image size .....	63	14	Metering .....	69
3	Sensitivity.....	62	15	Date and time.....	12
4	Flash mode.....	28	16	Number of available frames.....	106
5	Silent mode .....	17	17	Film simulation .....	65
6	Intelligent Face Detection indicator.....	20	18	Focus warning .....	17, 101
7	Dual IS mode .....	16	19	Blur warning.....	28, 101
8	Shooting mode.....	32	20	Dynamic range.....	62
9	Battery level.....	14	21	White balance .....	64
10	Macro (close-up) mode.....	27	22	Internal memory indicator* .....	8
11	Continuous shooting mode.....	68	23	Focus frame.....	17, 22
12	Quick AF .....	13, 71	24	Exposure compensation .....	25

### Playback

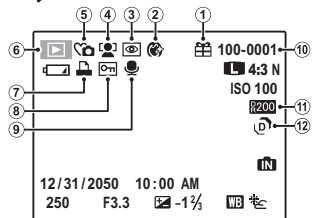

1	Gift image .....	40	7	DPOF print indicator .....	51
2	Portrait enhancer .....	36	8	Protected image.....	77
3	Red-eye removal indicator .....	20, 75	9	Voice memo indicator.....	80
4	Intelligent Face Detection indicator.....	20	10	Frame number.....	86
5	Silent mode indicator.....	17	11	Dynamic range.....	62
6	Playback mode indicator .....	40	12	<b>EXR</b> mode .....	32

## The Mode Dial

To select a shooting mode, align the mode icon with the mark next to the mode dial.

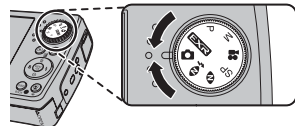

**EXR**: Improve clarity, reduce noise, increase dynamic range, or let the camera automatically adjust settings to suit the scene (pg. 32).

**📷 (AUTO)**: A simple “point-and-shoot” mode recommended for first-time users of digital cameras (pg. 14).

**🌞🌙 (NATURAL & ⚡)**: Helps ensure good results in situations with difficult lighting. Each time the shutter button is pressed, the camera takes two shots: one shot without the flash to preserve natural lighting, followed immediately by a second shot with the flash (pg. 34).

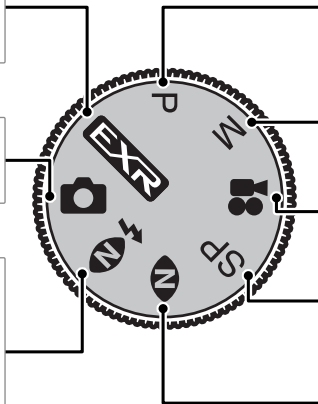

**P (PROGRAM AE)**: Select for full control over all camera settings except shutter speed (pg. 38). Choose between program and aperture-priority AE.

**M (MANUAL)**: Select for full control over camera settings, including shutter speed and aperture (pg. 37).

**📽️ (MOVIE)**: Record movies with sound (pg. 45).

**SP (SCENE POSITION)**: Choose a scene suited to the subject or shooting conditions and let the camera do the rest (pg. 35).

**🌞 (NATURAL LIGHT)**: Capture natural light indoors, under low light, or where the flash can not be used (pg. 35).

# Charging the Battery

The battery is not charged at shipment. Charge the battery before use.

## Batteries

The camera uses an NP-50 rechargeable battery.

### 1 Place the battery in the charger.

Insert the battery into the supplied battery charger as shown, making sure that the battery is in the orientation indicated by the  $\ominus \uparrow \oplus$  labels.

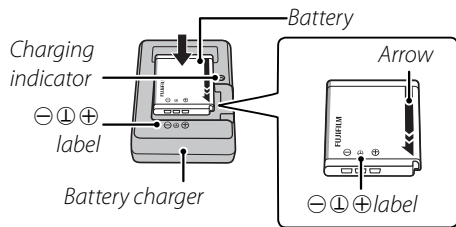

### 2 Plug the charger in.

Plug the charger into a power outlet. The charging indicator will light.

## ⚠ Cautions

- Unplug the charger when it is not in use.
- Remove dirt from the battery terminals with a clean, dry cloth. Failure to observe this precaution could prevent the battery from charging.
- Charging times increase at low temperatures.

## ● The Charging Indicator

The charging indicator shows battery charge status as follows:

Charging indicator	Battery status	Action
Off	Battery not inserted.	Insert the battery.
	Battery fully charged.	Remove the battery.
On	Battery charging.	—
Blinks	Battery fault.	Unplug the charger and remove the battery.

### 3 Charge the battery.

Remove the battery when charging is complete.

# Inserting the Battery

After charging the battery, insert it in the camera as described below.

## 1 Open the battery-chamber cover.

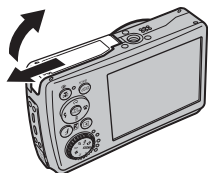

### Note

Be sure the camera is off before opening the battery-chamber cover.

### Cautions

- Do not open the battery-chamber cover when the camera is on. Failure to observe this precaution could result in damage to image files or memory cards.
- Do not use excessive force when handling the battery-chamber cover.

## 2 Insert the battery.

Insert the battery with the terminals first and the orange stripe aligned with the orange battery latch. Slide the battery into the camera, keeping the battery latch pressed to one side as shown below. Confirm that the battery is securely latched.

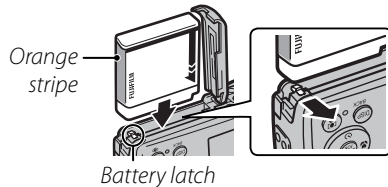
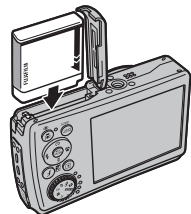

### Caution

Insert the battery in the correct orientation. **Do not use force or attempt to insert the battery upside down or backwards.** The battery will slide in easily in the correct orientation.

### 3 Close the battery-chamber cover.

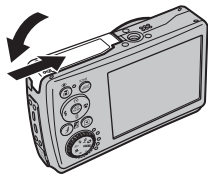

#### Removing the Battery

After turning the camera off, open the battery-chamber cover, press the battery latch to the side, and slide the battery out of the camera as shown.

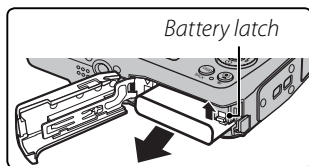

#### Caution

Turn the camera off before removing the battery.

#### Tips: Using an AC Adapter

- The camera can be powered by an optional AC adapter and DC coupler (sold separately). See manuals provided with the AC adapter and DC coupler for details.
- If the camera is powered by an AC adapter, demo mode instructions will be displayed when the camera is turned on. Selecting this option starts a slide show. To cancel, press the shutter button.

#### Cautions

- Do not affix stickers or other objects to the battery. Failure to observe this precaution could make it impossible to remove the battery from the camera.
- Do not short the battery terminals. The battery could overheat.
- Read the cautions on page v.
- Use only battery chargers designated for use with the battery. Failure to observe this precaution could result in product malfunction.
- Do not remove the labels from the battery or attempt to split or peel the outer casing.
- The battery gradually loses its charge when not in use. Charge the battery one or two days before use.

## Inserting a Memory Card

Although the camera can store pictures in internal memory, optional *xD-Picture Cards* and SD memory cards (sold separately) can be used to store additional pictures.

**When no memory card is inserted**,  appears in the monitor and internal memory is used for recording and playback. Note that because camera malfunction could cause internal memory to become corrupted, the pictures in internal memory should periodically be transferred to a computer and saved on the computer hard disk or on removable media such as CDs or DVDs. The pictures in internal memory can also be copied to a memory card (see page 78). To prevent internal memory from becoming full, be sure to delete pictures when they are no longer needed.

**When a memory card is inserted** as described below, the card will be used for recording and playback.

### ■ *Compatible Memory Cards*

*xD-Picture Cards* and SanDisk SD and SDHC memory cards have been approved for use in the camera. A complete list of approved memory cards is available at [http://www.fujifilm.com/products/digital\\_cameras/index.html](http://www.fujifilm.com/products/digital_cameras/index.html). Operation is not guaranteed with other cards. The camera can not be used with MultiMediaCard (MMC).

### **Caution**

SD memory cards can be locked, making it impossible to format the card or to record or delete images. Before inserting an SD memory card, slide the write-protect switch to the unlocked position.

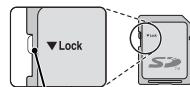

*Write-protect  
switch*

## ■ Inserting a Memory Card

**1** Open the battery-chamber cover.

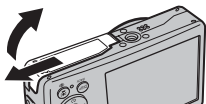

### ← Note

Be sure the camera is off before opening the battery-chamber cover.

**2** Insert the memory card.

Holding the memory card in the orientation shown below, slide it all the way in.

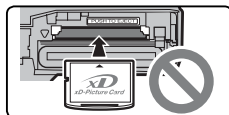
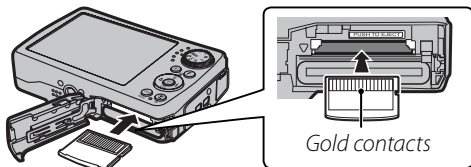

Be sure card is in correct orientation; do not insert at an angle or use force.

**3** Close the battery-chamber cover.

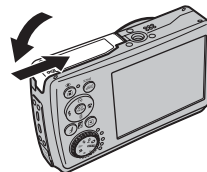

## ● Removing Memory Cards

After confirming that the camera is off, press the card in and then release it slowly. The card can now be removed by hand.

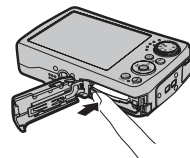

### ⚠ Cautions

- The memory card may spring out if you remove your finger immediately after pushing the card in.
- Memory cards may be warm to the touch after being removed from the camera. This is normal and does not indicate a malfunction.

## Cautions

- **Do not turn the camera off or remove the memory card while the memory card is being formatted or data are being recorded to or deleted from the card.** Failure to observe this precaution could damage the card.
- Format SD memory cards before first use, and be sure to reformat all memory cards after using them in a computer or other device. For more information on formatting memory cards, see page 88.
- Memory cards are small and can be swallowed; keep out of reach of children. If a child swallows a memory card, seek medical assistance immediately.
- Do not use miniSD or microSD adapters that expose the back of the card. Failure to observe this precaution may cause damage or malfunction. Adapters that are larger or smaller than the standard dimensions of an SD card may not eject normally; if the card does not eject, take the camera to an authorized service representative. Do not forcibly remove the card.
- Do not affix labels to memory cards. Peeling labels can cause camera malfunction.
- FUJIFILM *xD-Picture Cards* are recommended. Results can not be guaranteed with *xD-Picture Cards* from other manufacturers. The camera can be used with both type M and type H *xD-Picture Cards*; note, however, that type H cards are not compatible with the optional DPC-UD1 *xD-Picture Card* USB drive. The card type can be determined from the model number: for example, "DPC-M2GB" indicates a type M card.
- Movie recording may be interrupted with some types of SD memory card.
- The data in internal memory may be erased or corrupted when the camera is repaired. Please note that the repairer will be able to view pictures in internal memory.
- Formatting a memory card or internal memory in the camera creates a folder in which pictures are stored. Do not rename or delete this folder or use a computer or other device to edit, delete, or rename image files. Always use the camera to delete pictures from memory cards and internal memory; before editing or renaming files, copy them to a computer and edit or rename the copies, not the originals.

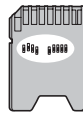



# Turning the Camera on and Off

## ***Shooting Mode***

Press the **ON/OFF** button to turn the camera on. The lens will extend and the lens cover will open.

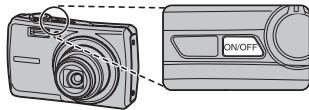

Press **ON/OFF** again to turn the camera off.

### **Tip: Switching to Playback Mode**

Press the **▶** button for about a second to start playback. Press the shutter button halfway to return to shooting mode.

### **Cautions**

- Forcibly preventing the lens from extending could cause damage or product malfunction.
- Pictures can be affected by fingerprints and other marks on the lens. Keep the lens clean.
- The **ON/OFF** button does not completely disconnect the camera from its power supply.

### **Tip: Auto Power Off**

The camera will turn off automatically if no operations are performed for the length of time selected in the **AUTO POWER OFF** menu (pg. 88; note that **OFF** is not available when an option other than **POWER SAVE** is selected for **POWER MANAGEMENT** or when **EXR AUTO** is selected in **EXR** mode). To turn the camera on, use the **ON/OFF** button or press the **▶** button for about a second.

## ***Playback Mode***

To turn the camera on and begin playback, press the **▶** button for about a second.

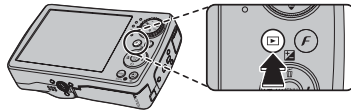

Press the **ON/OFF** button to turn the camera off.

### **Tip: Switching to Shooting Mode**

To exit to shooting mode, press the shutter button halfway. Press the **▶** button to return to playback.

# Basic Setup

A language-selection dialog is displayed the first time the camera is turned on. Set up the camera as described below (for information on resetting the clock or changing languages, see page 84).

## 1 Choose a language.



1.1 Press the selector up, down, left, or right to highlight a language.



1.2 Press **MENU/OK**.



## 2 Set the date and time.

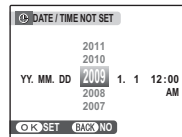

2.1 Press the selector left or right to highlight the year, month, day, hour, or minute and press up or down to change. To change the order in which the year, month, and day are displayed, highlight the date format and press the selector up or down.



2.2 Press **MENU/OK**.



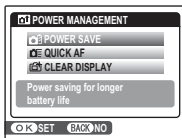

### 3 Choose power management options.



3.1 Press the selector up or down to highlight one of the following options:



-  **POWER SAVE:** Save battery power.
-  **QUICK AF:** Reduce focusing time, ensuring a quick shutter response.
-  **CLEAR DISPLAY:** Choose this option for a brighter, higher quality display.

3.2 Press **MENU/OK**.



#### **Tip: The Camera Clock**

If the battery is removed for an extended period, the camera clock will be reset and the language-selection dialog will be displayed when the camera is turned on. If the battery is left in the camera or an optional AC adapter connected for about four days, the battery can be removed for about seven days without resetting clock, language selection, or power management options.

## Taking Pictures in (Auto) Mode

This section describes how to take pictures in  (auto) mode.

- 1 Turn the camera on.**  
Press the **ON/OFF** button to turn the camera on.

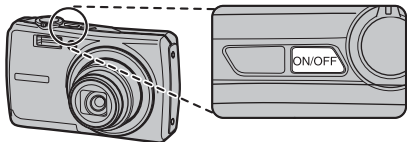



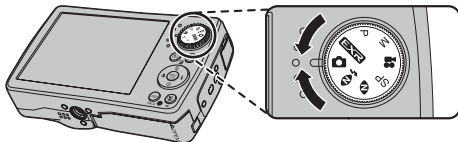

- 2 Select  mode.**  
Rotate the mode dial to .

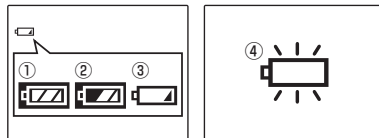

- 3 Check the battery level.**  
Check the battery level in the display.



Indicator	Description
 (white)	Battery partially discharged.
 (white)	Battery more than half discharged.
 (red)	Low battery. Charge as soon as possible.
 (blinks red)	Battery exhausted. Turn camera off and charge battery.

## 4 Frame the picture.

Position the main subject in the focus frame and use the zoom control to frame the picture in the display.

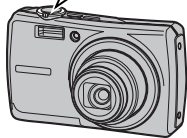
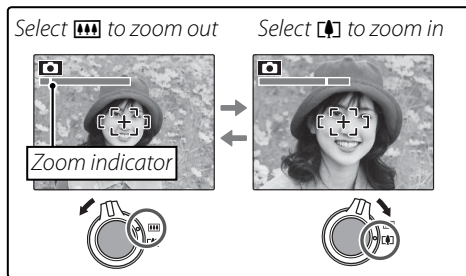

By default, the camera uses optical zoom only. If desired, digital zoom (pg. 87) can be used to zoom in closer.

## Holding the Camera

Hold the camera steady with both hands and brace your elbows against your sides. Shaking or unsteady hands can blur your shots.

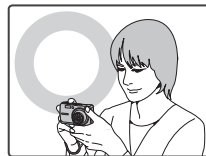

To prevent pictures that are out of focus or too dark (underexposed), keep your fingers and other objects away from the lens and flash.

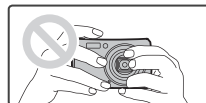

### Tip: Focus Lock

Use focus lock (pg. 22) to focus on subjects that are not in the focus frame.

## Framing Guideline and Post-Shot Assist Window

To choose the shooting information and guides displayed, press the **DISP/BACK** button.

*Indicators displayed*



*Indicators hidden*

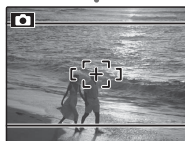



*HD framing*





*Best framing*

- **Best Framing:** To use the best framing, position the main subject at the intersection of two lines or align one of the horizontal lines with the horizon. Use focus lock (pg. 22) to focus on subjects that will not be in the center of the frame in the final photograph.
- **HD framing:** Displays the High Definition (HD) 16:9 crop.

## Avoiding Blurred Pictures

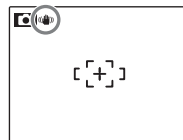
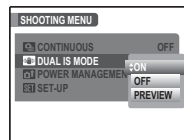
If the subject is poorly lit, blurring caused by camera shake can be reduced by selecting **ON** for the  **DUAL IS MODE** option in the shooting menu (pg. 67). In  mode, this also reduces blur caused by subject movement (dual IS mode).





 is displayed when dual IS is on.

Sensitivity is raised when dual IS is in effect. Note that blurring may still occur depending on the scene or shooting conditions.

 **Silent Mode**

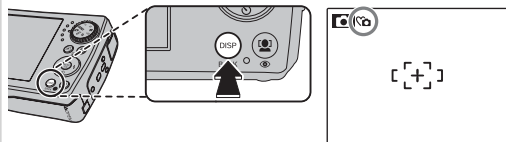
In situations in which camera sounds or lights may be unwelcome, hold the **DISP/BACK** button down until  is displayed (note that silent mode is not available during movie or voice memo playback).



The camera speaker, flash, and AF-assist illuminator/self-timer lamp turn off and flash and volume settings can not be adjusted (note that the flash will still fire in  mode). To restore normal operation, press the **DISP/BACK** button until the  icon is no longer displayed.

**5 Focus.**

Press the shutter button halfway to focus on the main subject in the focus frame.

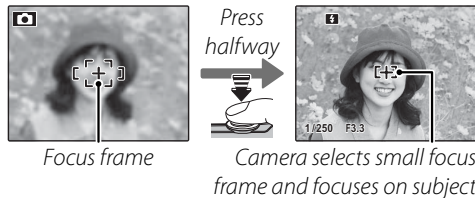
 **Note**

The lens may make a noise when the camera focuses. This is normal.

**If the camera is able to focus**, it will beep twice and the indicator lamp will glow green.

**If the camera is unable to focus**, the focus frame will turn red, **!AF** will be displayed, and the indicator lamp will blink green. Change the composition or use focus lock (pg. 22).

## 6 Shoot.

Smoothly press the shutter button the rest of the way down to take the picture.



### Tip: The Shutter Button

The shutter button has two positions. Pressing the shutter button halfway (①) sets focus and exposure; to shoot, press the shutter button the rest of the way down (②).

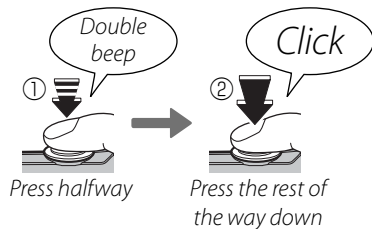

### Note

If the subject is poorly lit, the flash may fire when the picture is taken. For information on using the flash when lighting is poor, see page 28.

### The Indicator Lamp

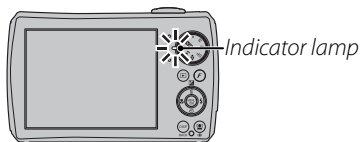

The indicator lamp shows camera status as follows:

Indicator lamp	Camera status
Glows green	Focus locked.
Blinks green	Blur, focus, or exposure warning. Picture can be taken.
Blinks green and orange	Recording pictures. Additional pictures can be taken.
Glows orange	Recording pictures. No additional pictures can be taken at this time.
Blinks orange	Flash charging; flash will not fire when picture is taken.
Blinks red	Lens or memory error (internal memory or memory card full or not formatted, format error, or other memory error).

### Tip: Warnings

Detailed warnings appear in the display. See pages 101–104 for more information.



# Viewing Pictures

Pictures can be viewed in the monitor. When taking important photographs, take a test shot and check the results.

- 1 Press the  button for about a second.

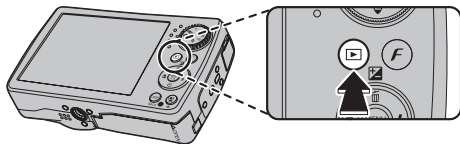

The most recent picture will be displayed in the monitor.



- 2 View additional pictures.

Press the selector right to view pictures in the order recorded, left to view pictures in reverse order.



Press the shutter button to exit to shooting mode.

## Deleting Pictures

To delete the picture currently displayed in the monitor, press the selector up (). The following dialog will be displayed.

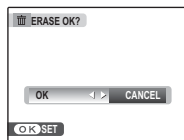

To delete the picture, press the selector left to highlight **OK** and press **MENU/OK**. To exit without deleting the picture, highlight **CANCEL** and press **MENU/OK**.



### Tip: The Playback Menu

Pictures can also be deleted from the playback menu (pg. 43).





## Intelligent Face Detection and Red-Eye Removal

Intelligent Face Detection allows the camera to automatically detect human faces and set focus and exposure for a face anywhere in the frame for shots that emphasize portrait subjects. Choose for group portraits (in vertical or horizontal orientations) to prevent the camera from focusing on the background. Intelligent Face Detection also offers a red-eye removal option for removing “red-eye” effects caused by the flash.

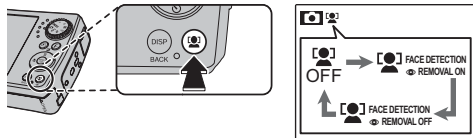
### 1 Turn Intelligent Face Detection on.

Press the  button to cycle through settings as shown below.



Option	Description
 OFF	Intelligent Face Detection and red-eye removal off.
 <b>FACE DETECTION</b>  <b>REMOVAL ON</b>	Intelligent Face Detection and red-eye removal on. Use with the flash.
 <b>FACE DETECTION</b>  <b>REMOVAL OFF</b>	Intelligent Face Detection on; red-eye removal off.

### 2 Frame the picture.

If a face is detected, it will be indicated by a green border. If there is more than one face in the frame, the camera will select the face closest to the center; other faces are indicated by white borders.



*Green border*

### 3 Focus.

Press the shutter button halfway to focus on the subject in the green border. Note that, in some shooting modes, exposure is adjusted for the current shooting mode and may not be optimized for the selected subject.



 **Caution**

If no face is detected when the shutter button is pressed halfway (pg. 96), the camera will focus on the subject at the center of the display and red-eye will not be removed.



**4 Shoot.**

Press the shutter button all the way down to shoot.



 **Caution**

If the subject moves as the shutter button is pressed, their face may not be in the area indicated by the green border when the picture is taken.

If  **FACE DETECTION**  **REMOVAL ON** is selected, the picture will be processed to reduce red-eye before it is recorded.



 **Tip: Red-Eye Removal**

Select **ON** for the  **SAVE ORG IMAGE** option in the setup menu (pg. 84) to save unprocessed copies of pictures created with red-eye removal.

 **Intelligent Face Detection**

Intelligent Face Detection is recommended when using the self-timer for group- or self-portraits (pg. 30).



When a picture taken with Intelligent Face Detection is displayed, the camera can automatically select faces for red-eye removal (pg. 75), playback zoom (pg. 41), slide shows (pg. 73), printing (pg. 49), and trimming (pg. 81).

# Focus Lock

To compose photographs with off-center subjects:

## 1 Position the subject in the focus frame.



## 2 Focus.

Press the shutter button halfway to set focus and exposure. Focus and exposure will remain locked while the shutter button is pressed halfway (AF/AE lock).



*Press  
halfway*



Repeat steps 1 and 2 as desired to refocus before taking the picture.

## 3 Recompose the picture.

Keeping the shutter button pressed halfway, recompose the picture.



## 4 Shoot.

Press the shutter-release button the rest of the way down to take the picture.



*Press the rest of  
the way down*

## Autofocus

Although the camera boasts a high-precision autofocus system, it may be unable to focus on the subjects listed below. If the camera is unable to focus using autofocus, use focus lock (pg. 22) to focus on another subject at the same distance and then recompose the photograph.

- Very shiny subjects such as mirrors or car bodies.
- Fast-moving subjects.
- Subjects photographed through a window or other reflective object.
- Dark subjects and subjects that absorb rather than reflect light, such as hair or fur.
- Insubstantial subjects, such as smoke or flame.
- Subjects that show little contrast with the background (for example, subjects in clothing that is the same color as the background).
- Subjects positioned in front of or behind a high-contrast object that is also in the focus frame (for example, a subject photographed against a backdrop of highly contrasting elements).



### The AF-Assist Illuminator

If the subject is poorly lit, the AF-assist illuminator will light to assist the focus operation when the shutter button is pressed halfway.

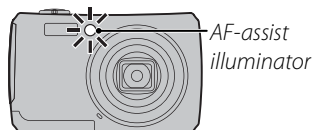

### Notes

- Avoid shining the AF-assist illuminator directly into your subject's eyes. See page 84 for information on disabling the AF-assist illuminator.
- The camera may be unable to focus using the AF-assist illuminator in some cases. If the camera is unable to focus in macro mode (pg. 27), try increasing the distance to the subject.
- The AF-assist illuminator is not available in silent mode.

## Exposure Compensation

Use exposure compensation when photographing very bright, very dark, or high-contrast subjects.

- 1 Press the selector up ()  
The exposure indicator will be displayed.

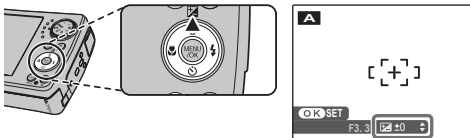

- 2 Choose a value.  
Press the selector button. The effect is visible in the display.

*Choose positive (+) values  
to increase exposure*



*Choose negative (-) values  
to reduce exposure*

- 3 Return to shooting mode.  
Press **MENU/OK** to return to shooting mode.
- 4 Take pictures.



### Note

A  icon and exposure indicator are displayed at settings other than  $\pm 0$ . Exposure compensation is not reset when the camera is turned off; to restore normal exposure control, choose a value of  $\pm 0$ .

**Choosing an Exposure Compensation Value**

- **Backlit subjects:** choose values from  $+2/3$  EV to  $+12/3$  EV (for an explanation of the term “EV”, see the Glossary on page 105)
  
- **Highly reflective subjects or very bright scenes** (e.g., snowfields): +1 EV
  
- **Scenes that are mostly sky:** +1 EV
- **Spotlit subjects** (particularly if photographed against dark backgrounds):  $-2/3$  EV
- **Subjects with low reflectivity** (pine trees or dark-colored foliage):  $-2/3$  EV





## Macro Mode (Close-ups)

For close-ups, press the selector left ()

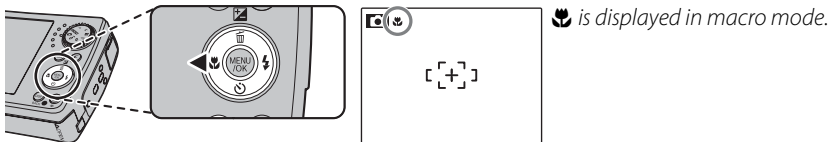

When macro mode is in effect, the camera focuses on subjects near the center of the frame. Use the zoom control to compose pictures.

To exit macro mode, press the selector left () . Macro mode can also be cancelled by turning the camera off or selecting another shooting mode.

### Notes

- Use of a tripod is recommended to prevent blur caused by camera shake.
- The flash may fail to light the entire subject at very short ranges. Increase the distance to the subject and try again.

## ⚡ Using the Flash (Intelligent Flash)

When the flash is used, the camera's *Intelligent Flash* system instantly analyzes the scene based on such factors as the brightness of the subject, its position in the frame, and its distance from the camera. Flash output and sensitivity are adjusted to ensure that the main subject is correctly exposed while preserving the effects of ambient background lighting, even in dimly-lit indoor scenes. Use the flash when lighting is poor, for example when shooting at night or indoors under low light.

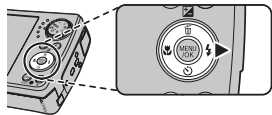

### 1 Choose a flash mode.

Press the selector right (➡). The flash mode changes each time the selector is pressed; in modes other than **AUTO**, the current mode is indicated by an icon in the display. Choose from the following options:



Mode	Description
<b>AUTO</b> (AUTO FLASH)	The flash fires when required. Recommended in most situations.
⚡ (FORCED FLASH)	The flash fires whenever a picture is taken. Use for backlit subjects or for natural coloration when shooting in bright light.
Ⓜ (SUPPRESSED FLASH)	The flash does not fire even when the subject is poorly lit. 📷 will appear in the monitor at slow shutter speeds to warn that pictures may be blurred. Use of a tripod is recommended.
<b>S</b> ⚡ (SLOW SYNCHRO)	Capture both the main subject and the background under low light (note that brightly lit scenes may be overexposed).

## 2 Focus.

Press the shutter button halfway to focus. If the flash will fire,  will be displayed when the shutter button is pressed halfway. At slow shutter speeds,  will appear in the display to warn that pictures may be blurred; use of a tripod is recommended.



## 3 Shoot.







Press the shutter button the rest of the way down to shoot.

### Caution

The flash may fire several times with each shot. Do not move the camera until shooting is complete.



### Red-Eye Removal

When  **FACE DETECTION**  **REMOVAL ON** is selected for Intelligent Face Detection (pg. 20), red-eye removal () is available in AUTO FLASH () , FORCED FLASH () , SUPPRESSED FLASH () , and SLOW SYNCHRO () modes. Red-eye removal minimizes “red-eye” caused when light from the flash is reflected from the subject’s retinas as shown in the illustration at right.



## ⌚ Using the Self-Timer

The camera offers a ten-second timer that allows photographers to appear in their own photographs, and a two-second timer that can be used to avoid blur caused by the camera moving when the shutter button is pressed. The self-timer is available in all shooting modes.

### 1 Set the timer.

The current self-timer mode is displayed in the monitor. To choose a different setting, press the selector down (⌚). The selection changes each time the selector is pressed.

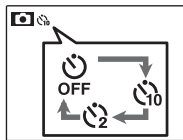
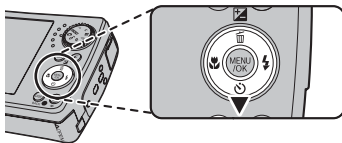

Choose from (self-timer off), (10 s delay), or (2 s delay)

### 2 Focus.

Press the shutter button halfway to focus.

#### Caution

Stand behind the camera when using the shutter button. Standing in front of the lens can interfere with focus and exposure.



### 3 Start the timer.

Press the shutter button the rest of the way down to start the timer. The display in the monitor shows the number of seconds remaining until the shutter is released. To stop the timer before the picture is taken, press **DISP/BACK**.

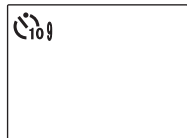

The self-timer lamp on the front of the camera will blink immediately before the picture is taken. If the two-second timer is selected, the self-timer lamp will blink as the timer counts down.

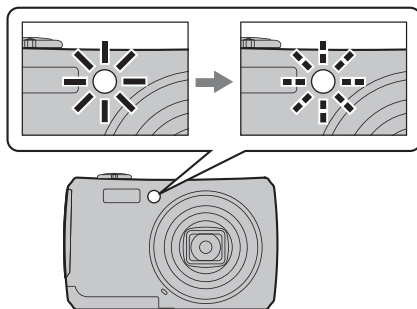

### Intelligent Face Detection

Because it ensures that the faces of portrait subjects will be in focus, Intelligent Face Detection (pg. 20) is recommended when using the self-timer for group portraits or self-portraits. To use the self-timer with Intelligent Face Detection, turn Intelligent Face Detection on, set the timer as described in Step 1, and then press the shutter button all the way down to start the timer. The camera will detect faces while the timer is counting down and adjust focus and exposure immediately before the shutter is released. Be careful not to move until the picture has been recorded.

### Note

The self-timer turns off automatically when the picture is taken, a different shooting mode is selected, playback mode is selected, or the camera is turned off.

# Shooting Mode

Choose a shooting mode according to the scene or type of subject. To choose a shooting mode, rotate the mode dial to the desired setting (pg. 4). The following modes are available:

## **AUTO**

Choose for crisp, clear snapshots (pg. 14). This mode is recommended in most situations.

## **EXR** **EXR**

To let the camera automatically optimize settings for your current subject, or to improve clarity, reduce noise, or enhance dynamic range, rotate the mode dial to **EXR** and follow the steps below:



- 1 Press **MENU/OK** to display the shooting menu.

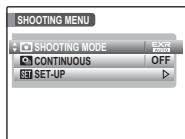

- 2 Highlight  **SHOOTING MODE**.







- 3 Press the selector right to display the following menu.



- 4 Press the selector up or down to highlight one of the following options.



Option	Description
 <b>EXR AUTO</b>	The camera automatically selects the scene and <b>EXR</b> mode according to shooting conditions.
 <b>RESOLUTION PRIORITY</b>	Choose for crisp, clear shots.
 <b>HIGH ISO &amp; LOW NOISE</b>	Reduce noise in pictures taken at high sensitivities.
 <b>D-RANGE PRIORITY</b>	Increase the amount of detail visible in highlights. <b>D-RANGE DYNAMIC RANGE</b> is set to <b>R800</b> (800%).

- 5 Press **MENU/OK** to select the highlighted option.









### **EXR AUTO**

In this mode, the camera automatically analyzes the composition and selects the appropriate scene mode according to the subject and shooting conditions. The selected mode is displayed as shown below. When the shutter button is pressed halfway, the camera selects the optimal EXR mode, which is displayed next to the scene mode icon.



*Display when portrait subject is detected.*

Mode	Type of subject or scene detected
	<b>Portrait:</b> Human portrait subject.
	<b>Landscape:</b> Man-made or natural landscape.
	<b>Night landscape:</b> Poorly lit landscape.
	<b>Macro:</b> Subject close to camera.
	<b>Back-lit portrait:</b> Back-lit portrait subject.
	<b>Night portrait:</b> Poorly lit portrait subject.

### IMAGE SIZE

If **AUTO** is selected for **IMAGE SIZE** in **EXTRAFIX** mode, the camera will automatically select the optimal image size.

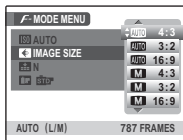

#### Notes

- **AUTO (AUTO)** will be selected if the subject does not match the scenes listed above.
- The camera focuses continuously, increasing the drain on the battery. The sound of the camera focusing may be audible.

### NATURAL & FLASH

This mode helps ensure good results with backlit subjects and in other situations with difficult lighting. Each time the shutter button is pressed, the camera takes two shots: one shot without the flash to preserve natural lighting, followed immediately by a second shot with the flash. Do not move the camera until shooting is complete.



#### Notes

- Do not use where flash photography is prohibited. The flash will fire even in silent mode.
- Only available if memory remains for two pictures.



## **N** **NATURAL LIGHT**

Capture natural light indoors, under low light, or where the flash can not be used. The flash turns off and sensitivity is raised to reduce blur.



## **SP** **SCENE POSITION**

The camera offers a choice of “scenes,” each adapted to particular shooting conditions or a specific type of subject, which can be assigned to the **SP** position on the mode dial:

- 1 Rotate the mode dial to **SP**.



- 2 Press **MENU/OK** to display the following menu.

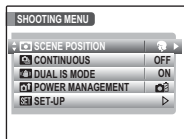

- 3 Highlight **SCENE POSITION**.



- 4 Press the selector right to display the following menu.

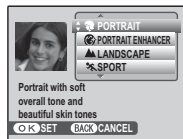

















- 5 Press the selector up or down to highlight a scene (pg. 36).



- 6 Press **MENU/OK** to select the highlighted option.



Until the setting is changed as described above, the chosen scene will be selected whenever the mode dial is rotated to **SP**.

Scene	Description
 <b>PORTRAIT</b>	Choose for soft-toned portraits with natural skin tones.
 <b>PORTRAIT ENHANCER</b>	Choose for a smooth skin effect in soft-focus portraits.
 <b>LANDSCAPE</b>	Choose for crisp, clear daylight shots of buildings and landscapes.
 <b>SPORT</b>	Choose when photographing moving subjects.  <b>QUICK AF</b> is automatically selected for  <b>POWER MANAGEMENT</b> and priority is given to faster shutter speeds.
 <b>NIGHT</b>	Choose this mode for poorly lit twilight or night scenes. Sensitivity is automatically raised to reduce blur caused by camera shake.
 <b>NIGHT (TRIPOD)</b>	Choose this mode for slow shutter speeds when shooting at night. Use a tripod to prevent blur.
 <b>FIREWORKS</b>	Slow shutter speeds are used to capture the expanding burst of light from a firework. Use a tripod to prevent blur.
 <b>SUNSET</b>	Record the vivid colors in sunrises and sunsets.
 <b>SNOW</b>	Choose for crisp, clear shots that capture the brightness of scenes dominated by shining white snow.
 <b>BEACH</b>	Choose for crisp, clear shots that capture the brightness of sunlit beaches.
 <b>UNDERWATER</b>	Choose for vivid blues when using an optional waterproof case to take photographs underwater.
 <b>MUSEUM</b>	Choose where flash photography is prohibited or the sound of the shutter may be unwelcome. The flash, speaker, and AF-assist illuminator/self-timer lamp turn off automatically. Note that photography may be prohibited altogether in some settings. Obtain permission before shooting.
 <b>PARTY</b>	Capture indoor background lighting under low-light conditions.
 <b>FLOWER</b>	Choose for vivid close-ups of flowers. The camera focuses in the macro range.
 <b>TEXT</b>	Take clear pictures of text or drawings in print. The camera focuses in the macro range.

## **M MANUAL**

In this mode, you choose both shutter speed and aperture. If desired, exposure can be altered from the value suggested by the camera.

**1** Rotate the mode dial to **M**.



**2** Press the  button. Shutter speed and aperture will be displayed.

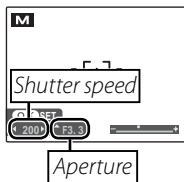

**3** Press the selector up or down to choose the aperture.



**4** Press the selector left or right to choose the shutter speed.



### **Caution**

Noise in the form of randomly-spaced bright pixels may occur in long exposures.

**5** Press **MENU/OK** to return to shooting mode.



**6** Take pictures.

### **The Exposure Indicator**

The amount the picture will be under- or over-exposed at current settings is shown by the exposure indicator.

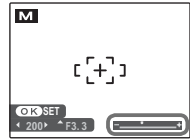

## **P PROGRAM AE/A APERTURE PRIORITY AE**

Mode **P** offers a choice of *program AE* (autoexposure), in which the camera sets exposure automatically, and *aperture priority AE*, in which you adjust aperture to soften background details or bring both background and foreground into focus while letting the camera control shutter speed for optimal exposure. To take pictures in program and aperture priority AE:

- 1** Rotate the mode dial to **P**.



- 2** Press **MENU/OK** to display the shooting menu.



- 3** Press the selector up or down to highlight **SHOOTING MODE**.



- 4** Press the selector right to display shooting mode options.



- 5** Press the selector up or down to highlight an option.

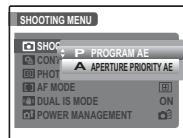

- 6** Press **MENU/OK** to select the highlighted option.



- 7 Press the selector up () to display exposure compensation (program AE) or aperture (aperture priority AE).

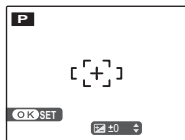

*Exposure compensation  
(program AE)*

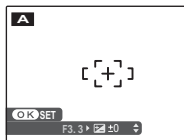

*Aperture  
(aperture priority AE)*

- 8 Press the selector button to choose exposure compensation (program AE) or aperture (aperture priority AE). If the correct exposure can not be achieved at the aperture selected for aperture priority AE, the shutter speed will be displayed in red.

- 9 Press **MENU/OK** to return to shooting mode.



- 10 Take pictures.

#### **Caution**

If the subject is outside the metering range of the camera, the shutter speed and aperture displays will show "---". Press the shutter button halfway to measure exposure again.

# Playback Options

To view the most recent picture in the monitor, press the  button.

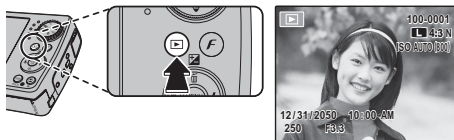

Press the selector right to view pictures in the order recorded, left to view pictures in reverse order. Keep the selector pressed to scroll rapidly to the desired frame.



## Choosing a Display Format

Press the **DISP/BACK** button to cycle through playback display formats as shown below.

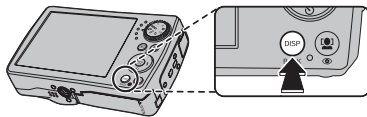

*Indicators displayed*



*Indicators hidden*





*Sort by date (pg.42)*

### ← Note

Pictures taken using other cameras are indicated by a  ("gift image") icon during playback.

## Playback Zoom

Select  to zoom in on pictures displayed in single-frame playback; select  to zoom out. When the picture is zoomed in, the selector can be used to view areas of the image not currently visible in the display.

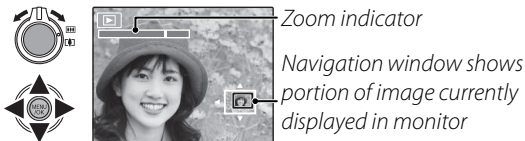



Press **DISP/BACK** to exit zoom.

### ← Note

Playback zoom is not available with cropped copies saved at a size of **640** or copies created with  **RE-SIZE** (pg. 82).

### ● Intelligent Face Detection

Pictures taken with Intelligent Face Detection (pg. 20) are indicated by a  icon. Press the  button to zoom in on the subject selected with Intelligent Face Detection. You can then use the zoom control to zoom in and out.



## Multi-Frame Playback

To change the number of images displayed, select  when a picture is shown full-frame in the monitor.



Select  to increase the number of pictures displayed to two, nine, or a hundred.



Select  to reduce the number of images displayed.

Use the selector to highlight images and press **MENU/OK** to view the highlighted image full frame. In the nine- and hundred-frame displays, press the selector up or down to view more pictures.

### Tip: Two-Frame Display

Two-frame display can be used to compare pictures taken in  mode.



## Sort by Date

Choose sort-by-date mode to view pictures taken on a selected date.

- 1 Press **DISP/BACK** until the sort-by-date screen is displayed.



- 2 Use the selector up or down to highlight a date. Keep the selector pressed to scroll rapidly to the desired date.



- 3 Press the selector left or right to scroll through the pictures taken on the highlighted date. Keep the selector pressed to scroll rapidly to the desired frame.





## Deleting Pictures

The **ERASE** option in the playback menu can be used to delete still pictures and movies, increasing the amount of space available on the memory card or in internal memory (for information on deleting pictures in single-frame playback, see page 19). *Note that deleted pictures can not be recovered. Copy important pictures to a computer or other storage device before proceeding.*

- 1** Press **MENU/OK** to display the playback menu.

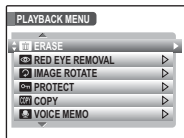

- 2** Press the selector up or down to highlight  **ERASE**.



- 3** Press the selector right to display delete options.

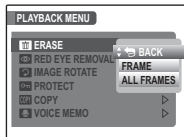

- 4** Press the selector up or down to highlight **FRAME** or **ALL FRAMES**.



- 5** Press **MENU/OK** to display options for the selected item (see following page).



### **Tips: Deleting Pictures**

- When a memory card is inserted, pictures will be deleted from the memory card; otherwise, pictures will be deleted from internal memory.
- Protected pictures can not be deleted. Remove protection from any pictures you wish to delete (pg. 77).
- If a message appears stating that the selected images are part of a DPOF print order, press **MENU/OK** to delete the pictures.

### ■ FRAME: *Deleting Selected Images*

Selecting **FRAME** displays the dialog shown at right.

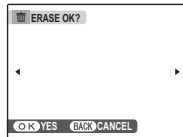

Press the selector left or right to scroll through pictures and press **MENU/OK** to delete the current picture (the picture is deleted immediately; be careful not delete the wrong picture).



Press **DISP/BACK** to exit when all the desired pictures have been deleted.

### ■ ALL FRAMES: *Deleting All Images*

Selecting **ALL FRAMES** displays the confirmation shown at right.

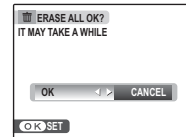

Highlight **OK** and press **MENU/OK** to delete all unprotected pictures.



The dialog shown at right is displayed during deletion. Press **DISP/BACK** to cancel before all pictures have been deleted (any pictures deleted before the button was pressed can not be recovered).

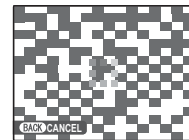

## Recording Movies

Shoot short movies at 30 frames per second. Sound is recorded via the built-in microphone; do not cover the microphone during recording.

- 1 Rotate the mode dial to  (movie mode).

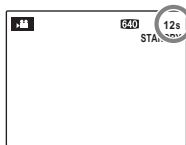

Display shows time available

- 2 Frame the scene using the zoom control.

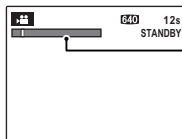

Zoom indicator

Zoom can not be adjusted once recording begins.

### Choosing the Frame Size

To choose the frame size, press the **F** button and select **QUALITY**. Choose **640** (640×480 pixels) for better quality, **820** (320×240 pixels) for longer movies. Press **MENU/OK** to return to movie recording mode.

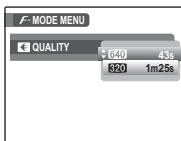

- 3** Press the shutter button all the way down to start recording.

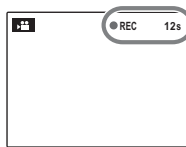

● **REC** and time remaining are displayed

**Tip**

There is no need to keep the shutter button pressed during recording.

**Notes**

- Focus is set when recording begins; exposure and white balance are adjusted automatically throughout recording. The color and brightness of the image may vary from that displayed before recording begins.
- If the subject is poorly lit, the AF-assist lamp may light to assist the focus operation. To turn the AF-assist lamp off, select **OFF** for the **AF AF ILLUMINATOR** option in the setup menu (pg. 84).

- 4** Press the shutter button halfway to end recording. Recording ends automatically when the movie reaches maximum length or memory is full.



**Caution**

The indicator lamp lights while movies are being recorded. Do not open the battery chamber card during shooting or while the indicator lamp is lit. Failure to observe this precaution could prevent the movie from being played back.

**Note**

Movies are recorded as monaural motion JPEG files.

## ▶ Viewing Movies

During playback, movies are displayed in the monitor as shown at right. The following operations can be performed while a movie is displayed:

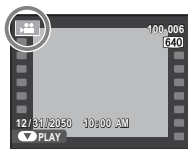

Operation	Description
Start/pause playback	<b>Press the selector down</b> to start playback. Press again to pause.
End playback/delete	<b>Press the selector up</b> to end playback. If playback is not in progress, pressing the selector up will delete the current movie.
Advance/rewind	<b>Press the selector right</b> to advance, <b>left</b> to rewind. If playback is paused, the movie will advance or rewind one frame each time the selector is pressed.
Adjust volume	<b>Press MENU/OK</b> to pause playback and display volume controls. Press the selector up or down to adjust the volume; press <b>MENU/OK</b> again to resume playback.

Progress is shown in the monitor during playback.

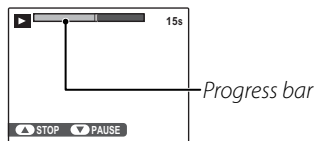

### Tip: Viewing Movies on a Computer

Copy movies to the computer before viewing.

### ⚠ Cautions

- Do not cover the speaker during playback.
- Vertical or horizontal streaks may appear in movies containing very bright subjects. This is normal and does not indicate a malfunction.

## Viewing Pictures on TV

Connect the camera to a TV and tune the television to the video channel to show pictures to a group. The supplied A/V cable connects as shown below; to connect to a High Definition (HD) TV, use an optional component video cable. Turn the camera off before connecting either cable.

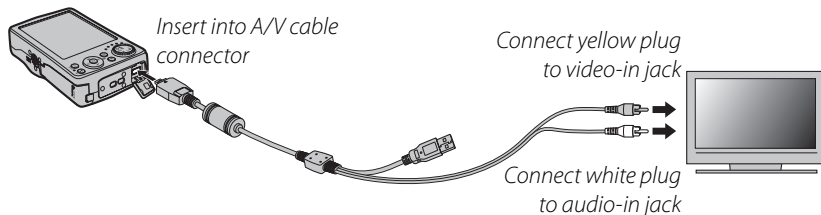

Press **▶** for about a second to turn the camera on. The camera monitor turns off and pictures and voice memos are played back on the TV. Note that the camera volume controls have no effect on sounds played on the TV; use the television volume controls to adjust the volume.

### ← Note

Image quality drops during movie playback.

### ⚠ Caution

When connecting the cable, be sure the connectors are fully inserted.

### ● Connecting the Camera to High Definition (HD) TVs

Optional HDC-1 component video cable can be used to connect the camera to High Definition (HD) televisions. Use the HDC-1 for devices with component video (Y, Pb/Cb, Pr/Cr) connectors.

# Printing Pictures via USB

If the printer supports PictBridge, the camera can be connected directly to the printer and pictures can be printed without first being copied to a computer. Note that depending on the printer, not all the functions described below may be supported.



## Connecting the Camera

- 1 Connect the supplied USB cable as shown and turn the printer on.

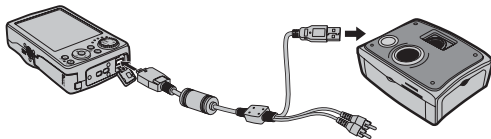

- 2 Press the button for about a second to turn the camera on. **USB** will be displayed in the monitor, followed by the PictBridge display shown below at right.

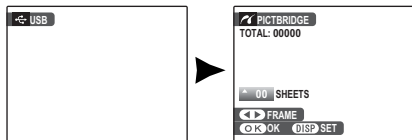

## Printing Selected Pictures

- 1 Press the selector left or right to display a picture you wish to print.



### Note

To print one copy of the current picture, proceed directly to Step 3.

- 2 Press the selector up or down to choose the number of copies (up to 99). Repeat steps 1–2 to select additional pictures.



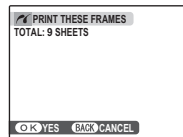

- 3 Press **MENU/OK** to display a confirmation dialog.



- 4 Press **MENU/OK** to start printing.



**Tip: Printing the Date of Recording**

To print the date of recording on pictures, press **DISP/BACK** in steps 1–2 to display the PictBridge menu (see “Printing the DPOF Print Order,” below). Press the selector up or down to highlight **PRINT WITH DATE**  and press **MENU/OK** to return to the PictBridge display (to print pictures without the date of recording, select **PRINT WITHOUT DATE**). To ensure that the date is correct, set the camera clock before taking pictures. Note that the **PRINT WITH DATE**  option is only available with printers that support date printing.

**← Notes**

- Use an optional AC adapter and DC coupler to power the camera for extended periods.
- Print pictures from internal memory or a memory card that has been formatted in the camera.
- Default printer page size and print quality settings are used when printing via direct USB connection.

**During Printing**

The message shown at right is displayed during printing. Press **DISP/BACK** to cancel before all pictures are printed (depending on the printer, printing may end before the current picture has printed).

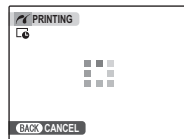

If printing is interrupted, press  to turn the camera off and then on again.

**Disconnecting the Camera**

Confirm that the above message is not displayed and turn the camera off. Disconnect the USB cable.



## ***Printing the DPOF Print Order***

To print the print order created with **PRINT ORDER (DPOF)** in the playback **F-MODE** menu (pg. 72):

- 1** In the PictBridge display, press **DISP/BACK** to open the PictBridge menu.

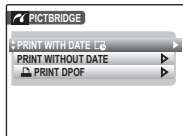

- 2** Press the selector up or down to highlight **PRINT DPOF**.



- 3** Press **MENU/OK** to display a confirmation dialog.

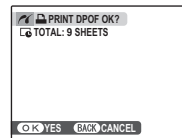

- 4** Press **MENU/OK** to start printing.



## Creating a DPOF Print Order



The  **PRINT ORDER (DPOF)** option in the playback **F-MODE** menu can be used to create a digital “print order” for PictBridge-compatible printers (pg. 51) or devices that support DPOF.

### DPOF

**DPOF** (Digital Print Order Format) is standard that allows pictures to be printed from “print orders” stored in internal memory or on a memory card. The information in the order includes the pictures to be printed and the number of copies of each picture.



### ■ WITH DATE /WITHOUT DATE

To modify the DPOF print order, select  **PRINT ORDER (DPOF)** in the playback **F-MODE** menu and press the selector up or down to highlight **WITH DATE ** or **WITHOUT DATE**.

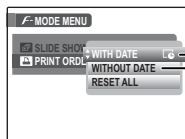

**WITH DATE **: Print date of recording on pictures.

**WITHOUT DATE**: Print pictures without date.

Press **MENU/OK** and follow the steps below.

- 1 Press the selector left or right to display a picture you wish to include in or remove from the print order.



- 2 Press the selector up or down to choose the number of copies (up to 99). To remove a picture from the order, press the selector down until the number of copies is 0.

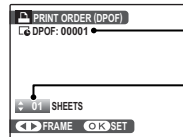

Total number of prints

Number of copies

### Tip: Intelligent Face Detection

If the current picture was created with Intelligent Face Detection, pressing  sets the number of copies to the number of faces detected.

**3** Repeat steps 1–2 to complete the print order. Press **MENU/OK** to save the print order when settings are complete, or **DISP/BACK** to exit without changing the print order.



**4** The total number of prints is displayed in the monitor. Press **MENU/OK** to exit.



The pictures in the current print order are indicated by a  icon during playback.



## ■ RESET ALL

To cancel the current print order, select **RESET ALL** in the  **PRINT ORDER (DPOF)** menu. The confirmation shown at right will be displayed; press **MENU/OK** to remove all pictures from the order.

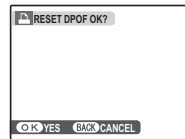

### ← Notes

- Remove the memory card to create or modify a print order for the pictures in internal memory.
- Print orders can contain a maximum of 999 pictures.
- If a memory card is inserted containing a print order created by another camera, the message shown at right will be displayed. Pressing **MENU/OK** cancels the print order; a new print order must be created as described above.

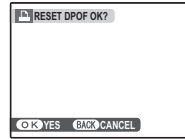

# Viewing Pictures on a Computer

The supplied FinePixViewer software can be used to copy pictures to a computer, where they can be stored, viewed, organized, and printed. Before proceeding, install FinePixViewer as described below. *Do NOT connect the camera to the computer until installation is complete.*

## ***Installing FinePixViewer***

FinePixViewer is available in Windows and Macintosh versions. Installation instructions for Windows are on pages 54–55, those for the Macintosh on pages 56–57.

### **Installing FinePixViewer: Windows**

**1** Confirm that the computer meets the following system requirements:

<b>OS</b>	Preinstalled versions of Windows Vista, Windows XP Home Edition (Service Pack 2), Windows XP Professional (Service Pack 2), or Windows 2000 Professional (Service Pack 4)
<b>CPU</b>	<ul style="list-style-type: none"><li>• <b>Windows Vista:</b> 800 MHz Pentium 4 or better (3 GHz Pentium 4 or better recommended)</li><li>• <b>Windows XP:</b> 800 MHz Pentium 4 or better (2 GHz Pentium 4 or better recommended)</li><li>• <b>Windows 2000:</b> 200 MHz Pentium or better</li></ul>
<b>RAM</b>	<ul style="list-style-type: none"><li>• <b>Windows Vista:</b> 512 MB or more (1 GB or more recommended)</li><li>• <b>Windows XP:</b> 512 MB or more</li><li>• <b>Windows 2000:</b> 128 MB or more</li></ul>
<b>Free disk space</b>	A minimum of 450 MB required for installation with 600 MB available when FinePixViewer is running (15 GB or more recommended under Windows Vista, 2 GB or more recommended under Windows XP)
<b>Video</b>	800 × 600 pixels or more with 16-bit color or better (1,024 × 768 pixels or more with 32-bit color recommended)
<b>Other</b>	<ul style="list-style-type: none"><li>• Built-in USB port recommended. Operation is not guaranteed other USB ports.</li><li>• Internet connection (56 kbps or faster recommended) required to use FinePix Internet Service; Internet connection and e-mail software required to use e-mail option.</li></ul>

#### **Caution**

Other versions of Windows are not supported. Operation is not guaranteed on home-built computers or computers that have been upgraded from earlier versions of Windows.

- 2 Start the computer. Log in to an account with administrator privileges before proceeding.
- 3 Exit any applications that may be running and insert the installer CD in a CD-ROM drive.

#### **Windows Vista**

If an AutoPlay dialog is displayed, click **SETUP.exe**. A “User Account Control” dialog will then be displayed; click **Allow**.

The installer will start automatically; click **Installing FinePixViewer** and follow the on-screen instructions to install FinePixViewer. Note that the Windows CD may be required during installation.

#### **If the Installer Does Not Start Automatically**

If the installer does not start automatically, select **Computer** or **My Computer** from the Start menu (Windows Vista/XP) or double-click the **My Computer** icon on the desktop (Windows 2000), then double-click the **FINEPIX** CD icon to open the FINEPIX CD window and double-click **SETUP** or **SETUP.exe**.

- 4 If prompted to install Windows Media Player or DirectX, follow the on-screen instructions to complete installation.
- 5 When prompted, remove the installer CD from the CD-ROM drive and click **Restart** to restart the computer. Store the installer CD in a dry location out of direct sunlight in case you need to re-install the software. The version number is printed at the top of the CD label for reference when updating the software or contacting customer support.

Installation is now complete. Proceed to “Connecting the Camera” on page 58.

## Installing FinePixViewer: Macintosh

1 Confirm that the computer meets the following system requirements:

<b>CPU</b>	PowerPC or Intel
<b>OS</b>	Pre-installed versions of Mac OS X version 10.3.9–10.4 (for the latest information, visit <a href="http://www.fujifilm.com/">http://www.fujifilm.com/</a> )
<b>RAM</b>	256 MB or more
<b>Free disk space</b>	A minimum of 200 MB required for installation with 400 MB available when FinePixViewer is running
<b>Video</b>	800 × 600 pixels or more with thousands of colors or better
<b>Other</b>	<ul style="list-style-type: none"> <li>• Built-in USB port recommended. Operation is not guaranteed other USB ports.</li> <li>• Internet connection (56 kbps or faster recommended) required to use FinePix Internet Service; Internet connection and e-mail software required to use e-mail option.</li> </ul>

2 After starting the computer and quitting any applications that may be running, insert the installer CD in a CD-ROM drive. Double-click the **FinePix CD** icon on the desktop and double-click **Installer for Mac OS X**.

3 An installer dialog will be displayed; click **Installing FinePixViewer** to start installation. Enter an administrator name and password when prompted and click **OK**, then follow the on-screen instructions to install FinePixViewer. Click **Exit** to quit the installer when installation is complete.

- 4** Remove the installer CD from the CD-ROM drive. Note that you may be unable to remove the CD if Safari is running; if necessary, quit Safari before removing the CD. Store the installer CD in a dry location out of direct sunlight in case you need to re-install the software. The version number is printed at the top of the CD label for reference when updating the software or contacting customer support.
- 5** Select **Applications** in the Finder **Go** menu to open the applications folder. Double-click the **Image Capture** icon and select **Preferences...** from the Image Capture application menu.

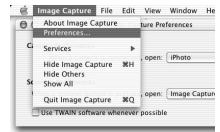

The Image Capture preferences dialog will be displayed. Choose **Other...** in the **When a camera is connected, open** menu, then select **FPVBridge** in the "Applications/FinePixViewer" folder and click **Open**.



Select **Quit Image Capture** from the Image Capture application menu.

Installation is now complete. Proceed to "Connecting the Camera" on page 58.

## ***Connecting the Camera***

**1** If the pictures you wish to copy are stored on a memory card, insert the card into the camera (pg. 8). If no card is inserted, pictures will be copied from internal memory.

### **Caution**

Loss of power during transfer could result in loss of data or damage to internal memory or the memory card. Charge the battery before connecting the camera.

**2** Turn the camera off and connect the supplied USB cable as shown, making sure the connectors are fully inserted. Connect the camera directly to the computer; do not use a USB hub or keyboard.

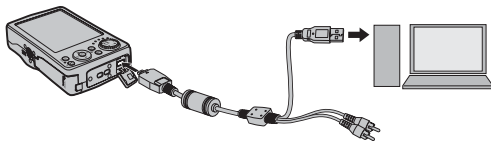

**3** Press the  button for about a second to turn the camera on. FinePixViewer will start automatically and the “Save Image Wizard” will be displayed. Follow the on-screen instructions to copy pictures to the computer. To exit without copying pictures, click **Cancel**.

### **Caution**

If FinePixViewer does not start automatically, the software may not be correctly installed. Disconnect the camera and reinstall the software.

For more information on using FinePixViewer, select **How to Use FinePixViewer** in the FinePixViewer **Help** menu.

### **Note**

The camera will not turn off automatically while connected to a computer.



## Cautions

- Use only memory cards that have been formatted in the camera and contain pictures taken with the camera. If a memory card containing a large number of images is inserted, there may be a delay before FinePixViewer starts and FinePixViewer may be unable to import or save images. Use a memory card reader to transfer pictures.
- Make sure the indicator lamp is out before turning the camera off, disconnecting the USB cable. Failure to observe this precaution could result in loss of data or damage to internal memory or the memory card.
- Disconnect the camera before inserting or removing memory cards.
- Use FinePixViewer to copy voice memos.
- In some cases, it may not be possible to access pictures saved to a network server using FinePixViewer in the same way as on a standalone computer.
- The user bears all applicable fees charged by the phone company or Internet service provider when using services that require an Internet connection.

## Disconnecting the Camera

After confirming that the indicator lamp is out, follow the on-screen instructions to turn the camera off and disconnect the USB cable.

## Updating FinePixViewer

The latest version of FinePixViewer can be downloaded from <http://www.fujifilm.com/>.

## Uninstalling FinePixViewer

Only uninstall FinePixViewer before reinstalling the software or when it is no longer required. After quitting FinePixViewer and disconnecting the camera, drag the “FinePixViewer” folder from “Applications” into the Trash and select **Empty Trash** in the **Finder** menu (Macintosh), or open the control panel and use “Programs and Features” (Windows Vista) or “Add or Remove Programs” (other versions of Windows) to uninstall FinePixViewer, FinePix Resource, and FinePix Studio. Under Windows, one or more confirmation dialogs may be displayed; read the contents carefully before clicking **OK**.

## Using the Menus: Shooting Mode

The **F**-mode and shooting menu contain settings for a wide range of shooting conditions.

### **Using the *F*-Mode Menu**

- 1 Press the **F** button to display the **F-MODE** menu.

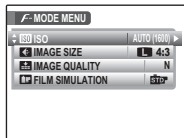

- 2 Press the selector up or down to highlight the desired menu item.



- 3 Press the selector right to display options for the highlighted item.

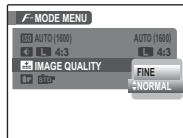



























- 4 Press the selector up or down to highlight the desired option.



- 5 Press **MENU/OK** to select the highlighted option.



## ***F-Mode Menu Options***

Menu item	Description	Options	Default
 <b>ISO</b>	Adjust ISO sensitivity (pg. 62). Choose higher values when the subject is poorly lit.	<b>AUTO</b> / <b>AUTO (3200)</b> / <b>AUTO (1600)</b> / <b>AUTO (800)</b> / <b>AUTO (400)</b> / <b>12800</b> / <b>6400</b> / <b>3200</b> / <b>1600</b> / <b>800</b> / <b>400</b> / <b>200</b> / <b>100</b>	<b>AUTO</b>
 <b>DYNAMIC RANGE</b>	Enhance details in highlights for natural contrast (pg. 62).	<b>AUTO</b> /  <b>100%</b> /  <b>200%</b> /  <b>400%</b> /  <b>800%</b>	<b>AUTO</b>
 <b>IMAGE SIZE</b>	Choose image size and aspect ratio (pg. 63).	 <b>4:3</b> /  <b>3:2</b> /  <b>16:9</b> /  <b>4:3</b> /  <b>3:2</b> /  <b>16:9</b> /  <b>4:3</b> /  <b>3:2</b> /  <b>16:9</b>	 <b>4:3</b>
 <b>IMAGE QUALITY</b>	Choose image quality (pg. 64).	<b>FINE</b> / <b>NORMAL</b>	<b>NORMAL</b>
 <b>WHITE BALANCE</b>	Adjust color for different light sources (pg. 64).	<b>AUTO</b> / 	<b>AUTO</b>
 <b>FILM SIMULATION</b>	Simulate the effects of different types of film (pg. 65).	 <b>PROVIA</b> / <b>STANDARD</b> /  <b>Velvia</b> / <b>VIVID</b> /  <b>ASTIA</b> / <b>SOFT</b> /  <b>B&amp;W</b> /  <b>SEPIA</b>	 <b>PROVIA</b> / <b>STANDARD</b>

### **Note**

Some options are not available in all shooting modes.

**ISO ISO**

Control the camera's sensitivity to light. Higher values can be used to reduce blur when lighting is poor; note, however, that mottling may appear in pictures taken at high sensitivities, particularly at settings above **1600**. If **AUTO** or an option such as **AUTO (3200)** is selected, the camera will adjust sensitivity automatically in response to shooting conditions. In the case of **AUTO (3200)**, **AUTO (1600)**, **AUTO (800)**, and **AUTO (400)**, the value in parentheses is the maximum sensitivity that will be selected when the subject is poorly lit.

Settings other than **AUTO** are shown by an icon in the display.

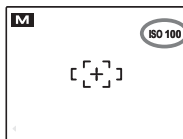
**D-Ring DYNAMIC RANGE**

Control contrast. Higher values are recommended for scenes that include both sunlight and deep shade or for increased contrast when photographing such subjects as sunlight on water, brightly-lit autumn leaves, and portraits taken against a blue sky; note, however, that mottling may appear in pictures taken at higher values. If **AUTO** is selected, the camera will automatically select values between 100% and 400% in response to shooting conditions.

**← Note**

**800 800%** is available only when **D-Ring DYNAMIC RANGE** is selected in **EXR** mode and an option other than **V Vivid/VIVID** or **S ASTIA/SOFT** is selected for **F FILM SIMULATION**.

## ◀ IMAGE SIZE

Choose the size and aspect ratio at which still pictures are recorded. Large pictures can be printed at large sizes with no drop in quality; small pictures require less memory, allowing more pictures to be recorded.

Option	Prints at sizes up to
<b>L</b> 4:3	34×25 cm (13.5×10 in.)
<b>L</b> 3:2	34×23 cm (13.5×9 in.)
<b>L</b> 16:9	34×19 cm (13.5×7.5 in.)
<b>M</b> 4:3	24×18 cm (9.5×7 in.)
<b>M</b> 3:2	24×16 cm (9.5×6 in.)
<b>M</b> 16:9	24×13 cm (9.5×5.5 in.)
<b>S</b> 4:3	17×13 cm (7×5 in.)
<b>S</b> 3:2	17×12 cm (7×4.5 in.)
<b>S</b> 16:9	17×9 cm (7×3.5 in.)

The number of pictures that can be taken at current settings (pg. 106) is shown to the right of the image quality icon in the display.

## ● Aspect Ratio

Pictures with an aspect ratio of 4:3 have the same proportions as the camera display. Pictures with an aspect ratio of 3:2 have the same proportions as a frame of 35-mm film, while an aspect ratio of 16:9 is suited to display on High Definition (HD) devices.

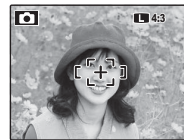

4:3



3:2



16:9

## ◀ Note









Image quality is not reset when the camera is turned off or another shooting mode is selected.

**📷 IMAGE QUALITY**

Choose how much image files are compressed. Select **FINE** (low compression) for higher image quality, **NORMAL** (high compression) to increase the number of pictures that can be stored.

**WB WHITE BALANCE**

For natural colors, choose a setting that matches the light source (for an explanation of “white balance,” see the Glossary on page 105).

Option	Description
<b>AUTO</b>	White balance adjusted automatically.
	Measure a value for white balance (pg. 65).
	For subjects in direct sunlight.
	For subjects in the shade.
	Use under “daylight” fluorescent lights.
	Use under “warm white” fluorescent lights.
	Use under “cool white” fluorescent lights.
	Use under incandescent lighting.
	For underwater photography.

If **AUTO** does not produce the desired results (for example, when taking close-ups), select  and measure a value for white balance (pg. 65) or choose the option that matches the light source.

**👉 Notes**

- At settings other than , auto white balance is used with the flash. Turn the flash off (pg. 28) to take pictures at other settings.
- Results vary with shooting conditions. Play pictures back after shooting to check colors in the monitor.

## ■ Custom White Balance

Choose  to adjust white balance for unusual lighting conditions. The options at right will be displayed; frame a white object so that it fills the monitor and press the shutter button all the way down to measure white balance.

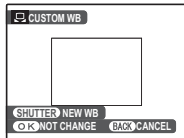

If **“COMPLETED!”** is displayed, press **MENU/OK** to set white balance to the measured value. This value is stored even when the battery is removed and can be reselected by pressing **MENU/OK** when custom white balance options are displayed.

If **“UNDER”** is displayed, raise exposure compensation (pg. 25) and try again.





If **“OVER”** is displayed, lower exposure compensation and try again.

### Tip

To give a deliberate color cast to your photographs, measure a value for custom white balance using a colored instead of a white object.

## FILM SIMULATION

Simulate the effects of different types of film, including sepia and black-and-white.

Option	Description
 <b>PROVIA/ STANDARD</b>	Standard color reproduction. Suited to a wide range of subjects, from portraits to landscapes.
 <b>Velvia/ VIVID</b>	A high-contrast palette of saturated colors, suited to nature photographs.
 <b>ASTIA/ SOFT</b>	A soft-toned palette of less saturated colors.
 <b>B&amp;W</b>	Take pictures in black and white.
 <b>SEPIA</b>	Take pictures in sepia.

## Using the Shooting Menu

- 1 Press **MENU/OK** to display the shooting menu.

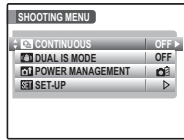

- 2 Press the selector up or down to highlight the desired menu item.



- 3 Press the selector right to display options for the highlighted item.

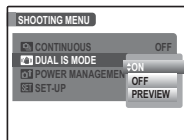

- 4 Press the selector up or down to highlight the desired option.























- 5 Press **MENU/OK** to select the highlighted option.





## Shooting Menu Options

Menu item	Description	Options	Default
 <b>SCENE POSITION</b>	Choose a scene for <b>SP</b> mode (pg. 35).		
 <b>SHOOTING MODE (P/A)</b>	Choose program or aperture priority AE for <b>P</b> mode (pg. 38).	<b>P / A</b>	<b>P</b>
 <b>SHOOTING MODE (EXR)</b>	Choose options for <b>EXR</b> mode (pg. 32).		<b>EXR</b>
 <b>CONTINUOUS</b>	Shoot a series of pictures (pg. 68).		<b>OFF</b>
 <b>PHOTOMETRY</b>	Choose how the camera meters exposure (pg. 69).		
 <b>AF MODE</b>	Choose how the camera selects a focus area (pg. 70).		
 <b>DUAL IS MODE</b>	Choose <b>ON</b> to reduce blur. To preview the effects of blur reduction, select <b>PREVIEW</b> . The preview will be displayed for 30s (during which time the DUAL IS icon will be displayed in green) and then dual IS will turn on (pg. 16).	<b>ON / OFF / PREVIEW</b>	<b>ON</b>
 <b>POWER MANAGEMENT</b>	Optimize camera performance for increased battery life, quick focus, or display quality (pg. 71).		
 <b>SET-UP</b>	Perform basic camera setup such as choosing a language and setting the time and date (pg. 83).		—

### ← Note

Some options are not available in all shooting modes.



## CONTINUOUS

Capture motion in a series of pictures.

### Notes



- The flash turns off automatically. The previously-selected flash mode is restored when **OFF** is selected for  **CONTINUOUS**.
- Frame rate varies with shutter speed.

### FINAL 12 / FINAL 3

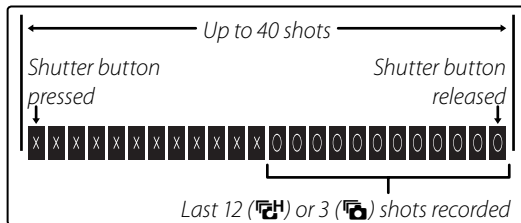
While the shutter button is pressed, the camera takes up to 40 pictures, but only the last 12 shots ( ) or 3 shots ( ) are recorded.



### TOP 12 / TOP 3

The camera takes up to 12 ( ) or 3 ( ) pictures while the shutter button is pressed.

### LONG PERIOD

The camera takes pictures while the shutter button is pressed. Shooting ends when the shutter button is released or memory is full.

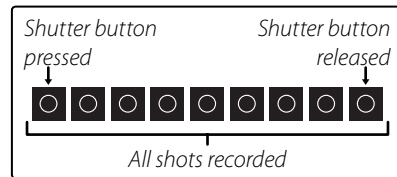

← **Notes:** TOP 12 / FINAL 12 / TOP 3 / FINAL 3

- Focus and exposure are determined by the first frame in each series.
- The number of pictures that can be recorded depends on the memory available. Additional time may be required to record pictures when shooting ends. The pictures are displayed in the monitor while recording is in progress.



← **Note: The Self-Timer**

If the self-timer is used, only one picture will be taken when FINAL 12, FINAL 3, or LONG PERIOD is selected.



**PHOTOMETRY**

Choose how the camera meters exposure when Intelligent Face Detection is off.

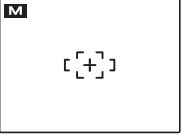

- **MULTI:** Automatic scene recognition is used to adjust exposure for a wide range of shooting conditions.
- **SPOT:** The camera meters lighting conditions at the center of the frame. Recommended when the background is much brighter or darker than the main subject. Can be used with focus lock (pg. 22) to meter off-center subjects.
- **AVERAGE:** Exposure is set to the average for the entire frame. Provides consistent exposure across multiple shots with the same lighting, and is particularly effective for landscapes and portraits of subjects dressed in black or white.

## AF MODE

This option controls how the camera selects the focus area. Regardless of the option selected, the camera will focus on the subject in the center of the monitor when macro mode is on (pg. 27).

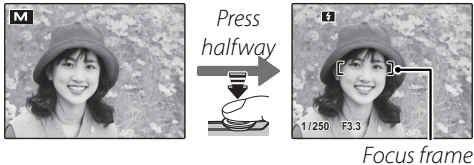

-  **CENTER:** The camera focuses on the subject in the center of the frame. This option can be used with focus lock. 
-  **MULTI:** When the shutter button is pressed halfway, the camera detects high-contrast subjects near the center of the frame and selects the focus area automatically (if the focus frame is not displayed, select  **CENTER** and use focus lock; pg. 22).





-  **CONTINUOUS:** While the shutter button is pressed halfway, the camera continuously adjusts focus to reflect changes in the distance to the main subject in the focus frame (see page 18; note that this increases the drain on the battery and that the sound of the camera focusing will be audible). Choose this option when photographing moving subjects. 

## POWER MANAGEMENT

Optimize camera performance for increased battery life, quick focus response, or improved display quality. The following options are available:

-  **POWER SAVE:** Monitor refresh rate is reduced. If no operations are performed for 10 s, the monitor will dim automatically to save power. This option is recommended when the camera is used for extended periods at high temperatures to prevent mottled vertical streaks from appearing in photographs.
-  **QUICK AF:** Reduces focusing time, ensuring a quick shutter response.
-  **CLEAR DISPLAY:** Choose this option for a brighter, higher quality display.

### Notes

-  **POWER SAVE** does not take effect when Intelligent Face Detection is on.
- At settings other than  **POWER SAVE**, the monitor will dim automatically if no operations are performed for 30 s. If **OFF** is selected for  **AUTO POWER OFF** (pg. 88), the camera will turn off automatically if no operations are performed for five minutes.

# Using the Menus: Playback Mode

The **F-MODE** and playback menus are used to manage the pictures in internal memory or on the memory card.

## Using the **F-Mode** Menu

1 Press the  button to enter playback mode (pg. 11).



2 Press the **F** button to display the **F-MODE** menu.

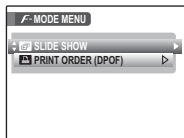

3 Press the selector up or down to highlight the desired menu item.



4 Press the selector right to display options for the highlighted item.

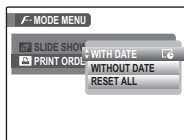



5 Press the selector up or down to highlight the desired option.



6 Press **MENU/OK** to select the highlighted option.





## **F-Mode** Menu Options

Option	Description
 <b>SLIDE SHOW</b>	View pictures in a slide show (pg. 73).
 <b>DISP ASPECT</b>	Choose a display mode for viewing photographs on an HD TV (pg. 73; available only when an HD cable is connected).
 <b>PRINT ORDER (DPOF)</b>	Select pictures for printing on DPOF- and PictBridge-compatible devices (pg. 52).

**SLIDE SHOW**

View pictures in an automated slide show. Choose the type of show and press **MENU/OK** to start. Press **DISP/BACK** at any time during the show to view on-screen help. When a movie is displayed, movie playback will begin automatically, and the slide show will continue when the movie ends. The show can be ended at any time by pressing **MENU/OK**.

Option	Displayed in
<b>NORMAL</b>	Press selector left or right to go back or skip ahead one frame. Select <b>FADE-IN</b> for fade transitions between frames.
<b>NORMAL</b> 	As above, except that camera automatically zooms in on faces selected with Intelligent Face detection.
<b>FADE-IN</b> 	
<b>MULTIPLE</b>	Display several pictures at once.

**Note**

The camera will not turn off automatically while a slide show is in progress.

**DISP ASPECT**

Choose the aspect ratio used when photographs with at a 4:3 aspect ratio (pg. 63) are viewed on a High Definition device (pg. 48). This option is only available when an optional component video cable is connected.

- **16:9**: The image fills the screen, with the top and bottom cropped out.
- **4:3**: The entire image is displayed, with black bands at the right and left sides.

Photographs with an aspect ratio of 16:9 are displayed full screen, those with an aspect ratio of 3:2 in a black frame.

## Using the Playback Menu

1 Press  to enter playback mode (pg. 11).



2 Press **MENU/OK** to display the playback menu.

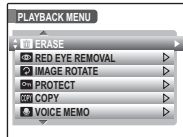

3 Press the selector up or down to highlight the desired menu item.



4 Press the selector right to display options for the highlighted item.

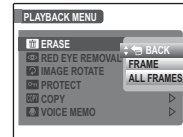

5 Press the selector up or down to highlight the desired option.



6 Press **MENU/OK** to select the highlighted option.





## ***Playback Menu Options***

The following options are available:

Option	Description
ERASE	Delete all or selected pictures (pg. 43).
RED-EYE REMOVAL	Create copies with reduced red eye (pg. 75).
IMAGE ROTATE	Rotate pictures (pg. 76).
PROTECT	Protect pictures from accidental deletion (pg. 77).
COPY	Copy pictures between internal memory and a memory card (pg. 78).
VOICE MEMO	Add voice memos to pictures (pg. 80).
TRIMMING	Create cropped copies of pictures (pg. 81).
RESIZE	Create small copies of pictures (pg. 82).
SET-UP	Perform basic camera setup (pg. 83).

### RED EYE REMOVAL

If the current picture is marked with a icon to indicate that it was taken with Intelligent Face Detection, this option can be used to remove red-eye. The camera will analyze the image; if red-eye is detected, the image will be processed to create a copy with reduced red-eye.

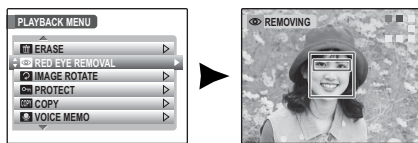

#### Notes

- Red eye may not be removed if the camera is unable to detect a face or the face is in profile. Results may differ depending on the scene. Red eye can not be removed from pictures that have already been processed using red-eye removal or pictures created with other devices.
- The amount of time needed to process the image varies with the number of faces detected.
- Copies created with **RED EYE REMOVAL** are indicated by a icon during playback.

## IMAGE ROTATE

By default, pictures taken in tall orientation are displayed in wide orientation. Use this option to display pictures in the correct orientation in the monitor. It has no effect on pictures displayed on a computer or other device.

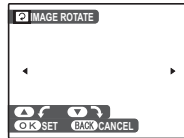

### Notes

- Protected pictures can not be rotated. Remove protection before rotating pictures (pg. 77).
- The camera may not be able to rotate pictures created with other devices.

To rotate a picture, play the picture back and select **IMAGE ROTATE** in the playback menu.

- 1 Press the selector down to rotate the picture 90° clockwise, up to rotate the picture 90° counterclockwise.

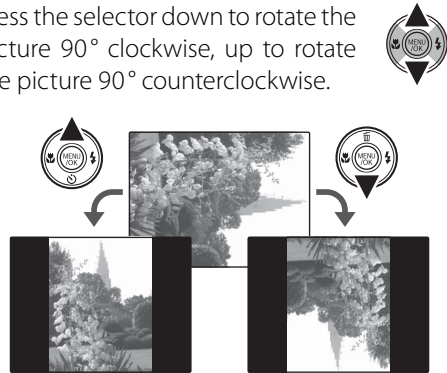

- 2 Press **MENU/OK** to confirm the operation (to exit without rotating the picture, press **DISP/BACK**).

The next time the picture is played back, it will automatically be rotated.

## PROTECT

Protect pictures from accidental deletion. The following options are available.

### ■ FRAME

Protect selected pictures.

- 1 Press the selector left or right to display the desired picture.

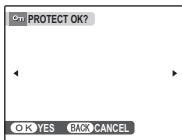

Picture not protected

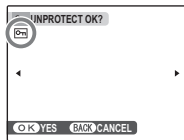

Protected picture

- 2 Press **MENU/OK** to protect the picture. If the picture is already protected, pressing **MENU/OK** will remove protection from the image.



- 3 Repeat steps 1–2 to protect additional images. Press **DISP/BACK** to exit when the operation is complete.



### ■ SET ALL

Press **MENU/OK** to protect all pictures, or press **DISP/BACK** to exit without changing picture status.

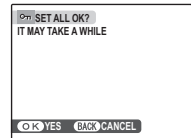

### ■ RESET ALL

Press **MENU/OK** to remove protection from all pictures, or press **DISP/BACK** to exit without changing picture status.

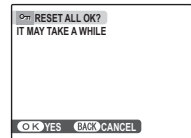

If the number of pictures affected is very large, the display at right will appear in the monitor while the operation is in progress. Press **DISP/BACK** to exit before the operation is complete.

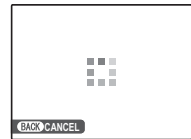

### Caution

Protected pictures will be deleted when the memory card or internal memory is formatted (pg. 88).

**COPY COPY**

Copy pictures between internal memory and a memory card.

- 1** Press the selector up or down to highlight **INTERNAL MEMORY** → **CARD** (copy pictures from internal memory to the memory card) or **CARD** → **INTERNAL MEMORY** (copy pictures from a memory card to internal memory).



- 2** Press the selector right to display options for the highlighted item.

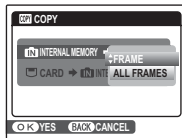

- 3** Press the selector up or down to highlight **FRAME** or **ALL FRAMES**.



- 4** Press **MENU/OK**.



**Tip: Copying Pictures Between Memory Cards**

To copy pictures between two memory cards, insert the source card and copy the pictures to internal memory, then remove the source card, insert the destination card, and copy the pictures from internal memory.

## ■ FRAME

Copy selected frames.

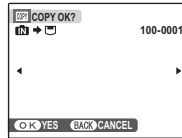

- 1 Press the selector left or right to display the desired picture.
- 2 Press **MENU/OK** to copy the picture.
- 3 Repeat steps 1–2 to copy additional images. Press **DISP/BACK** to exit when the operation is complete.



## ■ ALL FRAMES

Press **MENU/OK** to copy all pictures, or press **DISP/BACK** to exit without copying pictures.

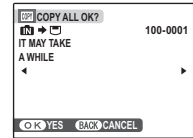

### ⚠ Cautions

- Copying ends when the destination is full.
- DPOF print information is not copied (pg. 52).

## VOICE MEMO

To add a voice memo to a still picture, select  **VOICE MEMO** after displaying the picture in playback mode.

### Note

Voice memos can not be added to movies or protected pictures. Remove protection from pictures before recording voice memos (pg. 77).

- 1 Hold the camera at a distance of about 20 cm (8 in.) and face the microphone.

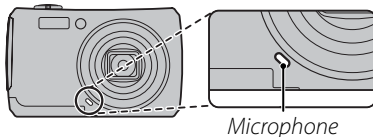

- 2 Press **MENU/OK** to start recording.

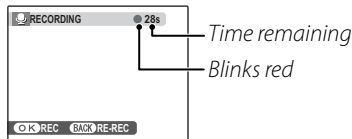

- 3 Press **MENU/OK** again to end recording. Recording ends automatically after 30 seconds.

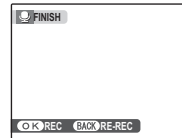

### Notes

- If a voice memo already exists for the current picture, the options at right will be displayed. Select **RE-REC** to replace the existing memo.
- Voice memos are recorded as PCM-format WAV files (pg. 105).

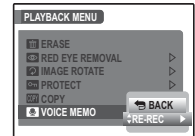

### Playing Voice Memos

Pictures with voice memos are indicated by a  icon during playback. To play the voice memo, press the selector down. To pause, press the selector down again; to end playback, press the selector up. Press the selector left to rewind, right to fast forward. Volume controls can be displayed by pressing the **MENU/OK** button; press the selector up or down to adjust the volume, and press **MENU/OK** again to resume playback.

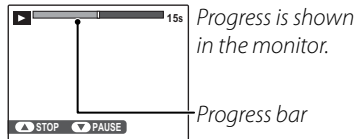

#### Note

The camera may not play voice memos recorded with other devices.

#### Caution

Do not cover the speaker during playback.

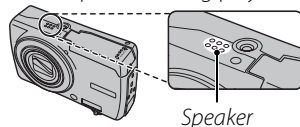

### TRIMMING

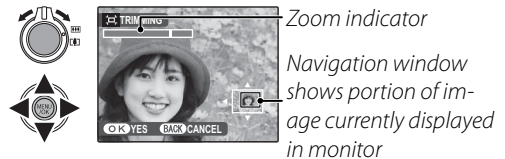

To create a cropped copy of a picture, play the picture back and select  **TRIMMING** in the playback menu (pg. 74).

- 1 Use the zoom control to zoom in and out and use the selector to scroll the picture until the desired portion is displayed (to exit to single-frame playback without creating a cropped copy, press **DISP/BACK**).



If the size of the final copy will be **640**, **OK** will be displayed in yellow.

**Tip: Intelligent Face Detection**

If the picture was shot with Intelligent Face Detection (pg. 20),  will be displayed in the monitor. Press the  button to zoom in on the selected face.



- 2** Press **MENU/OK**. A confirmation dialog will be displayed.

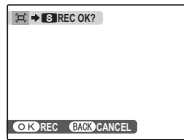

Copy size (**M**, **S**, or **640**) is shown at the top. Larger crops produce larger copies; all copies have an aspect ratio of 4:3.

- 3** Press **MENU/OK** to save the cropped copy to a separate file.

**RESIZE**

To create a small copy of a picture, play the picture back and select  **RESIZE** in the playback menu (pg. 74).

- 1 Press the selector up or down to highlight **640 STANDARD** or **320 SMALL**.
- 2 Press **MENU/OK** to select the highlighted option.
- 3 Press **MENU/OK** to copy the picture at the selected size.





# The Setup Menu

## Using the Setup Menu

### 1 Display the setup menu.

1.1 Press **MENU/OK** to display the menu for the current mode.



1.2 Press the selector up or down to highlight **SET SET-UP**.



1.3 Press the selector right to display the setup menu.

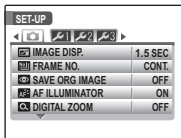

### 2 Choose a page.

2.1 Press the selector left or right to choose a page.



2.2 Press the selector down to enter the menu.



### 3 Adjust settings.

3.1 Press the selector up or down to highlight a menu item.



3.2 Press the selector right to display options for the highlighted item.

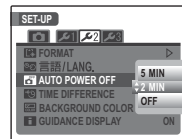





























3.3 Press the selector up or down to highlight an option.





3.4 Press **MENU/OK** to select the highlighted option.





## Setup Menu Options

	Menu item	Description	Options	Default
	 <b>IMAGE DISP.</b>	Choose how long pictures are displayed after shooting (pg. 85).	<b>3 SEC / 1.5 SEC / ZOOM (CONTINUOUS) / OFF</b>	<b>1.5 SEC</b>
	 <b>FRAME NO.</b>	Choose how files are named (pg. 86).	<b>CONTINUOUS / RENEW</b>	<b>CONTINUOUS</b>
	 <b>SAVE ORG IMAGE</b>	Choose whether to save unprocessed copies of pictures taken using red-eye removal.	<b>ON / OFF</b>	<b>OFF</b>
	 <b>AF ILLUMINATOR</b>	Turn the AF-assist illuminator on or off (pg. 24).	<b>ON / OFF</b>	<b>ON</b>
	 <b>DIGITAL ZOOM</b>	Enable or disable digital zoom (pg. 87).	<b>ON / OFF</b>	<b>OFF</b>
	 <b>DATE/TIME</b>	Set the camera clock.	—	—
	 <b>OPERATION VOL.</b>	Adjust the volume of camera controls.	 (high) /  (mid) /  (low) /  OFF (mute)	
	 <b>SHUTTER VOLUME</b>	Adjust the volume of the shutter sound.		
	 <b>SHUTTER SOUND</b>	Choose the sound made by the shutter.	<b>♪ 1 / ♪ 2</b>	<b>♪ 1</b>
	 <b>PLAYBACK VOLUME</b>	Adjust the volume for movie and voice memo playback (pg. 87).	—	<b>7</b>
	 <b>LCD BRIGHTNESS</b>	Control the brightness of the display (pg. 87).	—	<b>0</b>
	 <b>FORMAT</b>	Format internal memory or memory cards (pg. 88).	—	—
	 <b>言語 / LANG.</b>	Choose a language.	See page 110	<b>ENGLISH</b>
	 <b>AUTO POWER OFF</b>	Choose the auto power off delay (pg. 88).	<b>5 MIN / 2 MIN / OFF</b>	<b>2 MIN</b>
	 <b>TIME DIFFERENCE</b>	Set the clock to local time (pg. 89).	 / 	
	 <b>BACKGROUND COLOR</b>	Choose a color scheme for menus and cursors.	—	—
	 <b>GUIDANCE DISPLAY</b>	Choose whether to display tool tips.	<b>ON / OFF</b>	<b>ON</b>

Menu item	Description	Options	Default
 VIDEO SYSTEM	Choose a video mode for connection to a TV (pg. 48).	NTSC / PAL	—
 RESET	Reset all settings except <b>DATE/TIME</b> , <b>TIME DIFFERENCE</b> , <b>BACKGROUND COLOR</b> , and <b>VIDEO SYSTEM</b> to default values. A confirmation dialog will be displayed, press the selector left or right to highlight <b>OK</b> and press <b>MENU/OK</b> .	—	—

### IMAGE DISP.

Choose how long pictures are displayed in the monitor after shooting.

- **3 SEC**: Pictures are displayed for about 3 s before being recorded to the memory card.
- **1.5 SEC**: Pictures are displayed for about 1.5 s before being recorded to the memory card.
- **ZOOM (CONTINUOUS)**: Pictures are displayed until the **MENU/OK** button is pressed. Pictures can be zoomed in to check fine details. Note that **ZOOM (CONTINUOUS)** is disabled in  mode and when an option other than **OFF** is selected for  **CONTINUOUS** (pg. 68), and that the colors displayed at settings of **1.5 SEC** and **3 SEC** may differ from those in the final picture.

#### Note

Pictures taken in continuous shooting modes other than  are always displayed after shooting. Pictures taken in  mode are recorded without being displayed.

**☒ FRAME NO.**

New pictures are stored in image files named using a four-digit file number assigned by adding one to the last file number used. The file number is displayed during playback as shown at right. **FRAME NO.** controls whether file numbering is reset to 0001 when a new memory card is inserted or the current memory card or internal memory is formatted.

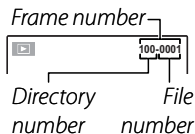



- **CONTINUOUS:** Numbering continues from the last file number used or the first available file number, whichever is higher. Choose this option to reduce the number of pictures with duplicate file names.
- **RENEW:** Numbering is reset to 0001 after formatting or when a new memory card is inserted.

**← Notes**

- If the frame number reaches 999-9999, the shutter release will be disabled (pg. 103).
- Selecting **☒ RESET** (pg. 85) resets **☒ FRAME NO.** to **CONTINUOUS** but does not reset frame numbering.
- Frame numbers for pictures taken with other cameras may differ.

## DIGITAL ZOOM

If **ON** is selected, selecting  at the maximum optical zoom position will trigger digital zoom, further magnifying the image. To cancel digital zoom, zoom out to the minimum digital zoom position and select .

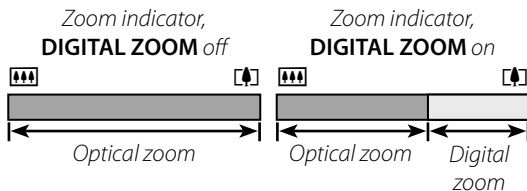
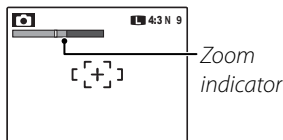

### Caution

Digital zoom produces lower quality images than optical zoom.

## PLAYBACK VOLUME

Press the selector up or down to choose volume for movie and voice memo playback and press **MENU/OK** to select.

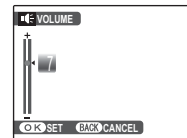

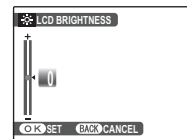

## LCD BRIGHTNESS

Press the selector up or down to choose display brightness and press **MENU/OK** to select.



## **FORMAT**

Format internal memory or a memory card. If a memory card is inserted in the camera,  will be displayed in the dialog shown at right and this option will format the memory card. If no memory card is inserted,  will be displayed and this option will format internal memory. Press the selector left to highlight **OK** and press **MENU/OK** to begin formatting.

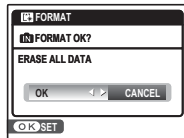

### **Cautions**

- All data—including protected pictures—will be deleted. Be sure important files have been copied to a computer or other storage device.
- Do not open the battery cover during formatting.

## **AUTO POWER OFF**

Choose the length of time before the camera turns off automatically when no operations are performed. Shorter times increase battery life; if **OFF** is selected, the camera must be turned off manually. Note that regardless of the option selected, the camera will not turn off automatically when connected to a printer (pg. 49) or computer (pg. 54) or when a slide show is in progress (pg. 73).

### **Tip: Reactivating the Camera**

To reactivate the camera after it has turned off automatically, use the **ON/OFF** button or press the  button for about a second (pg. 11).

## TIME DIFFERENCE

When travelling, use this option to switch the camera clock instantly from your home time zone to the local time at your destination.

### 1 Specify the difference between local time and your home time zone.

1.1 Press the selector up or down to highlight **← LOCAL**.



1.2 Press the selector right to display the time difference.

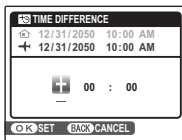

1.3 Press the selector left or right to highlight **+**, **-**, hours, or minutes; press up or down to edit. The minimum increment is 15 minutes.



1.4 Press **MENU/OK** when settings are complete.



### 2 Switch between local time and your home time zone.

To set the camera clock to local time, highlight **← LOCAL** and press **MENU/OK**. To set the clock to the time in your home time zone, select **HOME**. If **← LOCAL** is selected, **←** will be displayed in the monitor for three seconds after the camera enters shooting mode, and the date will be displayed in yellow.

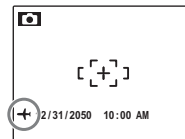

After changing time zones, check that the date and time are correct.

## Optional Accessories

The camera supports a wide range of accessories from FUJIFILM and other manufacturers.

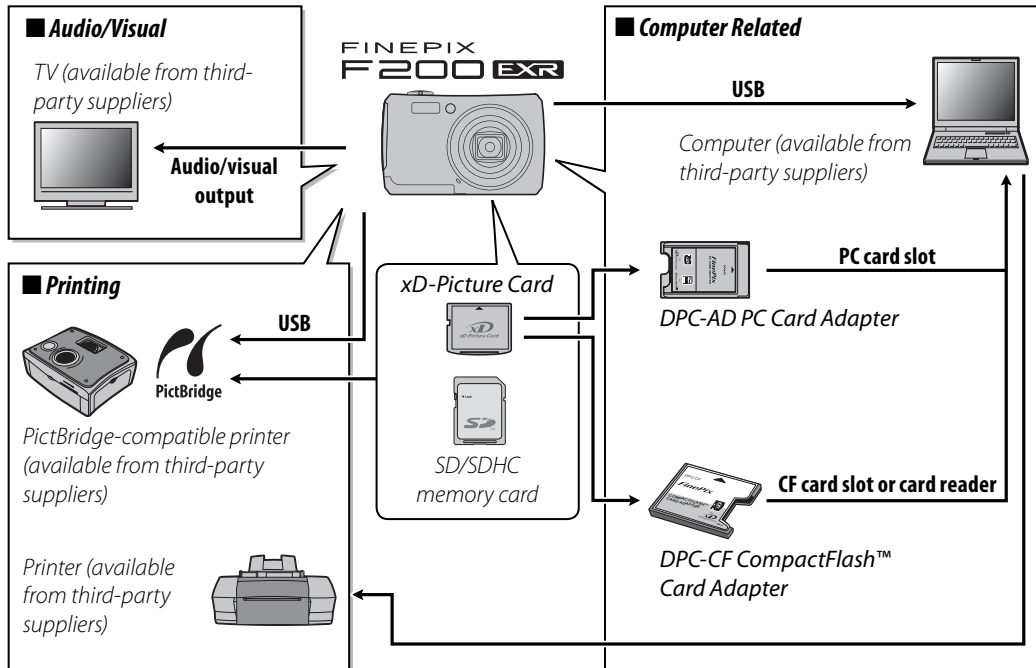



## ***Accessories from FUJIFILM***

The following optional accessories are available from FUJIFILM. For the latest information on the accessories available in your region, check with your local FUJIFILM representative or visit [http://www.fujifilm.com/products/digital\\_cameras/index.html](http://www.fujifilm.com/products/digital_cameras/index.html).

- **xD-Picture Cards:** Choose from 128MB, 1GB, and 2GB cards. Both type M and type H xD-Picture Cards can be used; note, however, that type H cards may not be compatible with accessories such as USB drives.
- **NP-50 rechargeable Li-ion battery** (supplied): Additional NP-50 large-capacity batteries can be purchased as required.
- **BC-50 battery charger** (supplied): Replacement battery chargers can be purchased as required. The BC-50 charges an NP-50 battery in about 140 minutes at +23 °C (+73 °F).
- **AC power adapter AC-5VX** (requires **DC coupler CP-50**): Use for extended playback or when copying pictures to a computer (shape of adapter and plug vary with region of sale).
- **DC coupler CP-50:** Connect the **AC power adapter AC-5VX** to the camera.
- **DPC-AD PC card adapter:** Allows an xD-Picture Card or a 3.3V SmartMedia card to function as a PC Card Standard-compliant ATA (PCMCIA 2.1) type II PC card.

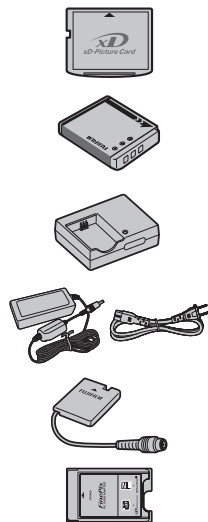

- **DPC-CF CompactFlash™ card adapter:** Allows an *xD-Picture Card* to function as a Compact-Flash card. The DPC-AD and DPC-CF can not be used with SD memory cards.
- **WP-FXF200 waterproof case** (not yet released): Allows the camera to be used at depths of up to 40 m (131 ft.). Camera controls can be adjusted and the flash can be used without removing the camera from the case.
- **HDC-1 component video cable for digital camera:** Connect the camera to High Definition (HD) televisions with component video (Y, Pb/Cb, Pr/Cr) connectors.

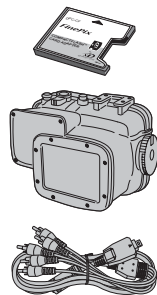

## Caring for the Camera

To ensure continued enjoyment of the product, observe the following precautions.

### **Storage and Use**

If the camera will not be used for an extended period, remove the battery and memory card. Do not store or use the camera in locations that are:

- exposed to rain, steam, or smoke
- very humid or extremely dusty
- exposed to direct sunlight or very high temperatures, such as in a closed vehicle on a sunny day
- extremely cold
- subject to strong vibration
- exposed to strong magnetic fields, such as near a broadcasting antenna, power line, radar emitter, motor, transformer, or magnet
- in contact with volatile chemicals such as pesticides
- next to rubber or vinyl products

### **Water and Sand**

Exposure to water and sand can also damage the camera and its internal circuitry and mechanisms. When using the camera at the beach or seaside, avoid exposing the camera to water or sand. Do not place the camera on a wet surface.

### **Condensation**

Sudden increases in temperature, such as occur when entering a heated building on a cold day, can cause condensation inside the camera. If this occurs, turn the camera off and wait an hour before turning it on again. If condensation forms on the memory card, remove the card and wait for the condensation to dissipate.

### **Cleaning**

Use a blower to remove dust from the lens and monitor, then gently wipe with a soft, dry cloth. Any remaining stains can be removed by wiping gently with a piece of FUJIFILM lens-cleaning paper to which a small amount of lens-cleaning fluid has been applied. Care should be taken to avoid scratching the lens or monitor. The camera body can be cleaned with a soft, dry cloth. Do not use alcohol, thinner, or other volatile chemicals.

### **Travelling**

Keep the camera in your carry-on baggage. Checked baggage may suffer violent shocks that could damage the camera.

# Troubleshooting

## Power and Battery

	Problem	Possible cause	Solution	Page
Power supply	The camera does not turn on.	The battery is exhausted.	Insert a fresh or fully-charged spare battery.	6
		The battery is not in the correct orientation.	Re-insert the battery in the correct orientation.	6
		The battery-chamber cover is not latched.	Latch the battery-chamber cover.	7
		The AC adapter and DC coupler are not connected properly.	Make sure that the AC adapter and DC coupler are properly connected.	—
	The battery runs down quickly.	The battery is cold.	Warm the battery by placing it in a pocket or other warm place and re-insert it in the camera immediately before taking a picture.	v
		There is dirt on the battery terminals.	Clean the terminals with a soft, dry cloth.	—
		The camera is in <b>EXR</b> mode.	Select another shooting mode.	32
		The battery has been charged many times.	The battery has reached the end of its charging life. Purchase a new battery.	—
		<b>QUICK AF</b> or <b>CLEAR DISPLAY</b> is selected for <b>POWER MANAGEMENT</b> .	Select <b>POWER SAVE</b> to reduce the drain on the battery.	—
	<b>CONTINUOUS</b> is selected for <b>AF MODE</b> .	Select a different AF mode.	70	
	The camera turns off suddenly.	The battery is exhausted.	Insert a fresh or fully-charged spare battery.	6
		The AC adapter or DC coupler has been disconnected.	Make sure that the AC adapter and DC coupler are properly connected.	—

Problem		Possible cause	Solution	Page
Battery charger	Charging does not start.	The battery is not correctly inserted.	Re-insert the battery in the charger.	5
		The battery is not in the correct orientation.	Re-insert the battery in the correct orientation.	5
	Charging is slow.	The temperature is low.	Charge the battery at room temperature.	v
	The charging lamp lights, but the battery does not charge.	There is dirt on the battery terminals.	Clean the terminals with a soft, dry cloth.	—
		The battery has been charged many times.	The battery has reached the end of its charging life. Purchase a new battery. If the battery still fails to charge, contact your FUJIFILM dealer.	—
	The charger is not correctly plugged into a power outlet.	Plug the charger correctly into the power outlet.	—	





### Menus and Displays

Problem		Possible cause	Solution	Page
Menus and displays are not in English.		English is not selected for the  言語/LANG.	Select <b>ENGLISH</b> .	12, 84

## Shooting

Problem		Possible cause	Solution	Page
Taking pictures	No picture is taken when the shutter button is pressed.	Memory is full.	Insert a new memory card or delete pictures.	8, 43
		Memory is not formatted.	Format the memory card or internal memory.	88
		There is dirt on the memory card contacts.	Clean the contacts with a soft, dry cloth.	—
		The memory card is damaged.	Insert a new memory card.	8
		The battery is exhausted.	Insert a fresh or fully-charged spare battery.	6
	The camera has turned off automatically.	Turn the camera on.	11	
The monitor goes dark after shooting.	The flash has fired.	The monitor may darken while the flash charges. Wait for the flash to charge.	28	
Focus	The camera does not focus.	The subject is close to the camera.	Select macro mode.	27
		The subject is far away from the camera.	Cancel macro mode.	
		The subject is not suited to autofocus.	Use focus lock.	22
EXR AUTO	Image size varies from shot to shot.	<b>AUTO</b> is selected for <b>◀ IMAGE SIZE</b> .	Select another image size or shooting mode.	32, 34, 61
Intelligent Face Detection	Face detection not available.	Intelligent Face Detection is not available in the current shooting mode.	Choose a different shooting mode.	32
	No face is detected.	The subject's face is obscured by sunglasses, a hat, long hair, or other objects.	Remove the obstructions.	20
		The subject's face occupies only a small area of the frame.	Change the composition so that the subject's face occupies a larger area of the frame.	
		The subject's head is at an angle or the subject is not facing the camera.	Ask the subject to face the camera and hold their head straight.	
		The camera is tilted.	Hold the camera straight.	15
		The subject's face is poorly lit.	Shoot in bright light.	—
Wrong subject selected.	The selected subject is closer to the center of the frame than the main subject.	Recompose the picture or turn face detection off and frame the picture using focus lock.	20, 22	

	Problem	Possible cause	Solution	Page
Close-ups	Macro mode is not available.	Macro mode is not available in the current shooting mode.	Choose a different shooting mode.	32
Flash	The flash does not fire.	The flash is charging.	Wait for the flash to charge.	28
		The flash is not available in the current shooting mode.	Choose a different shooting mode.	32
		The battery is exhausted.	Insert a fresh or fully-charged spare battery.	6
		An option other than <b>OFF</b> is selected for <b>CONTINUOUS</b> .	Turn <b>CONTINUOUS</b> off.	68
	Flash mode not available.	The desired flash mode is not available in the current shooting mode.	Choose a different shooting mode.	32
		The camera is in silent mode.	Turn silent mode off.	17
	The flash does not fully light the subject.	The subject is not in range of the flash.	Position the subject in range of the flash.	109
The flash window is obstructed.		Hold the camera correctly.	15	
Fast shutter speed selected.		Choose a slower shutter speed.	37	
AC adapter	Help text is displayed.	The camera was turned on while being powered by an AC adapter.	Follow the on-screen instructions to enter demo mode or press the shutter button to cancel.	—
Problem images	Pictures are blurred.	The lens is dirty.	Clean the lens.	93
		The lens is blocked.	Keep objects away from the lens.	15
		<b>!AF</b> is displayed during shooting and the focus frame is displayed in red.	Check focus before shooting.	101
		is displayed during shooting.	Use the flash or a tripod.	28
	Pictures are mottled.	Slow shutter speed selected and the subject is poorly lit.	Choose a faster shutter speed.	37
Vertical lines appear in pictures.	The camera has been used continuously at high temperatures.	Turn the camera off and wait for it to cool down.	—	



	<b>Problem</b>	<b>Possible cause</b>	<b>Solution</b>	<b>Page</b>
Recording	Pictures are not recorded.	Power was interrupted during shooting.	Turn the camera off before connecting the AC adapter/DC coupler. Leaving the camera on can result in corrupted files or damage to the memory card or internal memory.	—
Movies	Recording is interrupted.	Pictures have been repeatedly recorded to and deleted from a type M <i>xD-Picture Card</i> .	Format the card after copying any pictures you want to keep to another storage device.	—
Continuous	Only one picture is taken.	The self-timer is on and  <b>FINAL 12</b> ,  <b>FINAL 3</b> , or  <b>LONG PERIOD</b> is selected for  <b>CONTINUOUS</b> .	Turn the self-timer off.	69



## Playback

	Problem	Possible cause	Solution	Page
Pictures	Pictures are grainy.	The pictures were taken with a different make or model of camera.	—	—
	Playback zoom unavailable.	The pictures were created using  <b>RESIZE</b> or with a different make or model of camera.	—	41, 82
Audio	No sound in voice memo and movie playback.	The camera is in silent mode.	Turn silent mode off.	17
		Playback volume is too low.	Adjust playback volume.	87
		The microphone was obstructed.	Hold the camera correctly during recording.	80
		The speaker is obstructed.	Hold the camera correctly during playback.	81
Deletion	Selected pictures are not deleted.	Some of the pictures selected for deletion are protected.	Remove protection using the device with which it was originally applied.	77
Frame no.	File numbering is unexpectedly reset.	The battery-chamber cover was opened while the camera was on.	Turn the camera off before opening the battery-chamber cover.	6, 86

## Connections

	Problem	Possible cause	Solution	Page
TV	No picture or sound.	The camera is not properly connected.	Connect the camera correctly.	48
		An A/V cable was connected during movie playback.	Connect the camera once movie playback has ended.	47, 48
		Input on the television is set to "TV".	Set input to "VIDEO".	—
		The camera is not set to the correct video standard.	Match the camera  <b>VIDEO SYSTEM</b> setting to the TV.	85
		The volume on the television is too low.	Adjust the volume.	—
	No color.	The camera is not set to the correct video standard.	Match the camera  <b>VIDEO SYSTEM</b> setting to the TV.	85





Problem		Possible cause	Solution	Page
Computer	The computer does not recognize the camera.	The camera is not properly connected.	Connect the camera correctly.	58
	Pictures can not be printed.	The camera is not properly connected. The printer is off.	Connect the camera correctly. Turn the printer on.	49 —
PictBridge	Only one copy is printed.	The printer is not PictBridge-compatible.	—	—
	The date is not printed.			



### Miscellaneous

Problem		Possible cause	Solution	Page
Nothing happens when the shutter button is pressed.		Temporary camera malfunction.	Remove and reinsert the battery or disconnect and reconnect the AC adapter/DC coupler.	6
		The battery is exhausted.	Insert a fresh or fully-charged spare battery.	6
The camera does not function as expected.		Temporary camera malfunction.	Remove and reinsert the battery or disconnect and reconnect the AC adapter/DC coupler. If the problem persists, contact your FUJIFILM dealer.	6, 114

## Warning Messages and Displays

The following warnings are displayed in the monitor:

Warning	Description	Solution
 (red)	The battery is low.	Insert a fresh or fully-charged spare battery.
 (blinks red)	The battery is exhausted.	
	Slow shutter speed. Picture may be blurred.	Use the flash or mount the camera on a tripod.
<b>!AF</b> (displayed in red with red focus frame)	The camera can not focus.	<ul style="list-style-type: none"> <li>• Use focus lock to focus on another subject at the same distance, then recompose the picture (pg. 22).</li> <li>• If the subject is poorly lit, try focusing at a distance of about 2 m (6.6 ft.).</li> <li>• Use macro mode to focus when taking close-ups.</li> </ul>
Aperture or shutter speed shown in red	The subject is too bright or too dark. The picture will be over- or under-exposed.	If the subject is dark, use the flash.
<b>FOCUS ERROR</b>	Camera malfunction.	Turn the camera off and then on again, taking care not to touch the lens. If the message persists, contact a FUJIFILM dealer (pg. 114).
<b>ZOOM ERROR</b>		
<b>LENS CONTROL ERROR</b>		
<b>NO CARD</b>	No memory card inserted when  <b>COPY</b> is selected in the playback menu.	Insert a memory card.
<b>CARD NOT INITIALIZED</b>	The memory card or internal memory is not formatted or the memory card was formatted in a computer or other device.	Format the memory card or internal memory using the  <b>FORMAT</b> option in the camera setup menu (pg. 88).
	The memory card contacts require cleaning.	Clean the contacts with a soft, dry cloth. If the message is repeated, format the memory card (pg. 88). If the message persists, replace the memory card.
	Camera malfunction.	Contact a FUJIFILM dealer (pg. 114).
<b>PROTECTED CARD</b>	The memory card is locked.	Unlock the memory card (pg. 8).
<b>BUSY</b>	The memory card is incorrectly formatted.	Use the camera to format the memory card (pg. 88).

Warning	Description	Solution
CARD ERROR	The memory card is not formatted for use in the camera.	Format the memory card (pg. 88).
	The memory card contacts require cleaning or the memory card is damaged.	Clean the contacts with a soft, dry cloth. If the message is repeated, format the memory card (pg. 88). If the message persists, replace the memory card.
	Incompatible memory card.	Use a compatible memory card.
	Camera malfunction.	Contact a FUJIFILM dealer (pg. 114).
 MEMORY FULL	The memory card or internal memory is full; pictures can not be recorded or copied.	Delete pictures or insert a memory card with more free space.
 MEMORY FULL		
INTERNAL MEMORY IS FULL INSERT A NEW CARD		
WRITE ERROR	Memory card error or connection error.	Re-insert the memory card or turn the camera off and then on again. If the message persists, contact a FUJIFILM dealer (pg. 114).
	Not enough memory remaining to record additional pictures.	Delete pictures or insert a memory card with more free space.
	The memory card or internal memory is not formatted.	Format the memory card or internal memory (pg. 88).
READ ERROR	The file is corrupt or was not created with the camera.	The file can not be played back.
	The memory card contacts require cleaning.	Clean the contacts with a soft, dry cloth. If the message is repeated, format the memory card (pg. 88). If the message persists, replace the memory card.
	Camera malfunction.	Contact a FUJIFILM dealer (pg. 114).

Warning	Description	Solution
FRAME NO. FULL	The camera has run out of frame numbers (current frame number is 999-9999).	Format the memory card and select <b>RENEW</b> for the <b>FRAME NO.</b> option in the <b>SET-UP</b> menu. Take a picture to reset frame numbering to 100-0001, then return to the <b>FRAME NO.</b> menu and select <b>CONTINUOUS</b> .
TOO MANY FRAMES	Date for which more than 4,999 pictures exist selected in sort-by-date view.	Choose a different date.
CAN NOT EXECUTE CAN NOT EXECUTE	Red-eye removal can not be applied to the selected picture or movie.	—
PROTECTED FRAME	An attempt was made to delete, rotate, or add a voice memo to a protected picture.	Remove protection before deleting, rotating, or adding voice memos to pictures.
ERROR	Voice memo file is corrupt. Camera malfunction.	The voice memo can not be played back. Contact a FUJIFILM dealer (pg. 114).
NO IMAGE	The source device selected in the playback	Select a different source.
NO IMAGE	<b>COPY</b> menu contains no pictures.	
CAN NOT TRIM	An attempt was made to crop a  picture.	These pictures can not be cropped.
CAN NOT TRIM	The picture selected for cropping is damaged or was not created with the camera.	
DPOF FILE ERROR	The DPOF print order on the current memory card contains more than 999 images.	Copy the pictures to internal memory and create a new print order.
CAN NOT SET DPOF	The picture can not be printed using DPOF.	—
CAN NOT SET DPOF	Movies can not be printed using DPOF.	—
CAN NOT ROTATE	The picture can not be rotated.	—
CAN NOT ROTATE	Movies can not be rotated.	—

Warning	Description	Solution
PRESS AND HOLD THE DISP BUTTON TO DEACTIVATE SILENT MODE	An attempt was made to choose a flash mode or adjust the volume with the camera in silent mode.	Exit silent mode before choosing a flash mode or adjusting the volume.
COMMUNICATION ERROR	A connection error occurred while pictures were being printed or copied to a computer or other device.	Confirm that the device is turned on and that the USB cable is connected.
PRINTER ERROR	Printer out of paper or ink, or other printer error.	Check printer (see printer manual for details). To resume printing, turn the printer off and then turn it back on.
PRINTER ERROR RESUME?		Check printer (see printer manual for details). If printing does not resume automatically, press <b>MENU/OK</b> to resume.
CAN NOT BE PRINTED	An attempt was made to print a movie, a picture not created with the camera, or a picture in a format not supported by the printer.	Movies and some pictures created with other devices can not be printed. If the picture was created with the camera, check the printer manual to confirm that the printer supports the JFIF-JPEG or Exif-JPEG format. If it does not, the pictures can not be printed.

## Glossary

**Digital zoom:** Unlike optical zoom, digital zoom does not increase the amount of visible detail. Instead, details visible using optical zoom are simply enlarged, producing a slightly “grainy” image.

**DPOF (Digital Print Order Format):** A standard that allows pictures to be printed from “print orders” stored in internal memory or on a memory card. The information in the order includes the pictures to be printed and the number of copies of each picture.



**EV (Exposure Value):** The exposure value is determined by the sensitivity of the image sensor and the amount of light that enters the camera while the image sensor is exposed. Each time the amount of light doubles, EV increases by one; each time the amount of light is halved, EV decreases by one. The amount of light entering the camera can be controlled by adjusting aperture and shutter speed.

**Exif Print:** A standard that allows information stored with pictures to be used for optimal color reproduction during printing.

**JPEG (Joint Photographic Experts Group):** A compressed file format for color images. The higher the compression rate, the greater the loss of information and more noticeable drop in quality when the picture is displayed.

**Motion JPEG:** An AVI (Audio Video Interleave) format that stores sound and JPEG images in a single file. Motion JPEG files can be played in Windows Media Player (requires DirectX 8.0 or later) or QuickTime 3.0 or later.

**Smear:** A phenomenon specific to CCDs which causes white streaks to appear when very bright light sources, such as the sun or reflected sunlight, appear in the frame.

**WAV (Waveform Audio Format):** A standard Windows audio file format. WAV files have the extension “\*.WAV” and may be compressed or uncompressed. The camera uses uncompressed WAV. WAV files can be played using Windows Media Player or QuickTime 3.0 or later.

**White balance:** The human brain automatically adapts to changes in the color of light, with the result that objects that appear white under one light source still appear white when the color of the light source changes. Digital cameras can mimic this adjustment by processing images according to the color of the light source. This process is known as “white balance.”

## Internal Memory/Memory Card Capacity

The following table shows the recording time or number of available frames at different image qualities. All figures are approximate; file size varies with the scene recorded, producing wide variations in the number of files that can be stored. The number of exposures or length remaining may not diminish at an even rate.

	L 4:3		L 3:2		L 16:9		M 4:3		M 3:2		M 16:9		
	FINE	NORMAL	FINE	NORMAL	FINE	NORMAL	FINE	NORMAL	FINE	NORMAL	FINE	NORMAL	
<b>Size (pixels)</b>	4000×3000		4000×2664		4000×2248		2816×2112		2816×1864		2816×1584		
<b>File size</b>	4.7MB	3.0MB	4.2MB	2.6MB	3.5MB	2.2MB	2.9MB	1.5MB	2.6MB	1.3MB	2.2MB	1.1MB	
<b>Internal memory</b> (approx. 48MB)	10	16	11	18	13	21	16	32	18	37	22	43	
<b>xD Picture Card</b>	<b>128 MB</b>	25	40	30	45	35	55	40	85	45	95	55	110
	<b>256 MB</b>	50	85	60	95	70	110	85	170	95	190	110	220
	<b>512 MB</b>	100	170	120	190	140	220	170	340	190	380	220	440
	<b>1 GB</b>	210	340	240	380	280	450	340	680	390	770	450	900
	<b>2 GB</b>	430	680	480	770	570	910	690	1360	770	1520	910	1770
<b>SD card</b>	<b>512 MB</b>	100	160	110	180	130	220	160	330	180	370	220	430
	<b>1 GB</b>	200	330	230	370	270	440	330	660	370	740	440	870
	<b>2 GB</b>	410	660	460	740	550	880	670	1310	750	1470	880	1720
<b>SDHC card</b>	<b>4 GB</b>	830	1330	930	1490	1110	1770	1340	2640	1510	2950	1770	3440
	<b>8 GB</b>	1680	2670	1880	3000	2240	3550	2700	5290	3030	5920	3550	6910
	<b>16 GB</b>	3330	5310	3740	5950	4450	7050	5370	10510	6020	11760	7050	13720



	S 4:3		S 3:2		S 16:9		640	320	
	FINE	NORMAL	FINE	NORMAL	FINE	NORMAL			
<b>Size (pixels)</b>	2048×1536		2048×1360		1920×1080		640×480	320×240	
<b>File size</b>	1.6MB	800KB	1.4MB	720KB	1.0MB	700KB	—	—	
<b>Internal memory</b> (approx. 48MB)	31	61	35	68	46	71	43 sec.	1 min. 25 sec.	
<b>xD-Picture Card</b>	<b>128 MB</b>	80	150	90	170	120	180	1 min.	3 min.
	<b>256 MB</b>	160	310	180	350	240	360	3 min.	7 min.
	<b>512 MB</b>	320	620	360	700	480	720	7 min.	14 min.
	<b>1 GB</b>	640	1250	720	1420	960	1450	14 min.	29 min.
	<b>2 GB</b>	1270	2460	1450	2780	1930	2900	29 min.	59 min.
<b>SD card</b>	<b>512 MB</b>	310	600	350	680	460	700	7 min.	14 min.
	<b>1 GB</b>	620	1210	700	1370	930	1400	14 min.	28 min.
	<b>2 GB</b>	1230	2380	1400	2690	1870	2810	29 min.	57 min.
<b>SDHC card</b>	<b>4 GB</b>	2480	4770	2820	5390	3760	5640	58 min.*	114 min.*
	<b>8 GB</b>	4980	9570	5650	10820	7540	11310	116 min.*	230 min.*
	<b>16 GB</b>	9880	19000	11230	21480	14970	22460	231 min.*	457 min.*

\* Total length of all movie files. Individual movies can not exceed 2 GB, regardless of capacity of memory card.

# Specifications

System	
<b>Model</b>	Digital Camera FinePix F200EXR
<b>Effective pixels</b>	12 million
<b>CCD</b>	1/4-in. Super CCD EXR
<b>Storage media</b>	• Internal memory (approx. 48 MB) • SD/SDHC memory cards (see page 8) • <i>xD-Picture Cards</i> (16 MB–2 GB)
<b>File system</b>	Compliant with Design Rule for Camera File System (DCF), Exif 2.2, and Digital Print Order Format (DPOF)
<b>File format</b>	• <b>Still pictures:</b> Exif 2.2 JPEG (compressed) • <b>Movies:</b> AVI-format Motion JPEG • <b>Audio:</b> monaural WAV
<b>Image size (pixels)</b>	• <b>L 4:3:</b> 4,000 × 3,000 • <b>L 3:2:</b> 4,000 × 2,664 • <b>L 16:9:</b> 4,000 × 2,248 • <b>M 4:3:</b> 2,816 × 2,112 • <b>M 3:2:</b> 2,816 × 1,864 • <b>M 16:9:</b> 2,816 × 1,584 • <b>S 4:3:</b> 2,048 × 1,536 • <b>S 3:2:</b> 2,048 × 1,360 • <b>S 16:9:</b> 1,920 × 1,080
<b>File size</b>	See pages 106–107
<b>Lens</b>	Fujinon 5 × optical zoom lens, F/3.3 (wide angle)–5.1 (telephoto)
<b>Focal length</b>	f=6.4 mm–32 mm (35-mm format equivalent: 28 mm–140 mm)
<b>Digital zoom</b>	Approx. 4.4 × (up to 22 × when combined with optical zoom)
<b>Aperture</b>	F3.3/F9.0 (wide angle), F5.1/F14 (telephoto), uses Neutral Density (ND) filter
<b>Focus range (distance from front of lens)</b>	Approx. 45 cm (1.5 ft.)–infinity (wide angle); 80 cm (2.6 ft.)–infinity (telephoto) Macro: approx. 5 cm–80 cm/0.2 ft.–2.6 ft. (wide angle); 50 cm–1 m/1.6 ft.–3.3 ft. (telephoto) Quick AF: approx. 1 m (3.3 ft.)–infinity (wide angle); 2 m (6.6 ft.)–infinity (telephoto)
<b>Sensitivity</b>	Standard output sensitivity equivalent to ISO 100, 200, 400, 800, 1600, 3200, 6400 (image size <b>M</b> or <b>S</b> ), 12800 (image size <b>S</b> only); <b>AUTO (400)</b> , <b>AUTO (800)</b> , <b>AUTO (1600)</b> , <b>AUTO (3200)</b>
<b>Metering</b>	256-segment through-the-lens (TTL) metering; MULTI, SPOT, AVERAGE
<b>Exposure control</b>	Program and 2-stop aperture-priority autoexposure; manual exposure
<b>Exposure compensation</b>	–2 EV +2 EV in increments of 1/3 EV ( <b>EXR</b> and <b>P</b> modes)

<b>System</b>	
<b>Scene modes</b>	(NATURAL AND FLASH LIGHTING),  (NATURAL LIGHT),  (PORTRAIT),  (PORTRAIT ENHANCER),  (LANDSCAPE),  (SPORT),  (NIGHT),  (NIGHT (TRIPOD)),  (FIREWORKS),  (SUNSET),  (SNOW),  (BEACH),  (UNDERWATER),  (MUSEUM),  (PARTY),  (FLOWER),  (TEXT)
<b>Picture stabilization</b>	Optical stabilization (CCD shift)
<b>Intelligent Face Detection</b>	Available
<b>Shutter speed</b>	<ul style="list-style-type: none"> <li>: 1/8 s–1/1,500 s (combined mechanical and electronic shutter)</li> <li>: 3 s–1 s (combined mechanical and electronic shutter)</li> <li>: 4 s–1/2 s (combined mechanical and electronic shutter)</li> <li><b>Manual selection:</b> 8 s–1/1,000 s</li> <li><b>Aperture selection:</b> 1/4 s–1/1,000 s (combined mechanical and electronic shutter)</li> <li><b>Other modes:</b> 1/4 s–1/1,500 s (combined mechanical and electronic shutter)</li> </ul>
<b>Continuous</b>	<ul style="list-style-type: none"> <li>: up to 1.4 fps; max. 3 frames</li> <li>: maximum number of frames varies with image size and available memory</li> <li>: up to 5 fps; max. 12 frames</li> <li>: up to 1.4 fps; last 3 frames recorded</li> <li>: up to 5 fps; last 12 frames recorded</li> </ul>
<b>Focus</b>	<ul style="list-style-type: none"> <li><b>Mode:</b> Single AF, continuous AF</li> <li><b>Focus-area selection:</b> Center, auto-area</li> <li><b>Autofocus system:</b> Contrast-detect TTL AF</li> </ul>
<b>White balance</b>	Automatic scene detection; seven manual preset modes for direct sunlight, shade, daylight fluorescent, warm white fluorescent, cool white fluorescent, incandescent, and underwater lighting; custom white balance
<b>Self-timer</b>	Off, 2 sec., 10 sec.
<b>Flash</b>	Auto flash; effective range when sensitivity is set to <b>AUTO</b> is approx. 60 cm–4.3 m/2 ft.–14.1 ft. (wide angle), 60 cm–2.8 m/2 ft.–9.2 ft. (telephoto), or 30 cm–80 cm/1 ft.–2.6 ft. (macro mode)
<b>Flash modes</b>	Auto, forced flash, off, slow synchro (red-eye removal off); auto with red-eye removal, forced flash with red-eye removal, off, slow synchro with red-eye removal (red-eye removal on)

System	
<b>Monitor</b>	3.0-in., 230k-dot amorphous silicon TFT color LCD monitor
<b>Frame coverage</b>	Approx. 100%
<b>Movies</b>	Frame size 640 × 480 or 320 × 240 pixels; 30 fps; monaural sound; zoom not available
<b>Shooting options</b>	EXR mode (EXR AUTO, RESOLUTION PRIORITY, HIGH ISO & LOW NOISE, D-RANGE PRIORITY), Dynamic range, Intelligent Face Detection with red-eye removal, power management, framing guideline, frame number memory, and film simulation
<b>Playback options</b>	Intelligent Face Detection, red-eye removal, micro thumbnail, multi-frame playback, sort-by-date, trimming, resize, slide show, image rotation, and voice memo
<b>Other options</b>	PictBridge, Exif Print, language selection (Simplified Chinese, Traditional Chinese, Czech, Dutch, English, French, German, Hungarian, Italian, Japanese, Korean, Polish, Portuguese, Russian, Spanish, Swedish, Thai, and Turkish), time difference, silent mode
Input/output terminals	
<b>A/V OUT</b> (audio/video output)	8-pin multi-connector for NTSC or PAL output with monaural sound
<b>HD OUT</b> (high-definition output)	Analog component/HDC-1 component video cable for digital camera
<b>Digital input/output</b>	USB 2.0 High Speed; shares A/V OUT connector

**Power supply/other****Power supply** NP-50 rechargeable battery; optional AC power adapter AC-5VX and DC coupler CP-50**Guide to the number of available frames for battery operation**

Battery Type	Number of frames
NP-50	Approx. 230 frames

According to the CIPA (Camera & Imaging Products Association) standard procedure for measuring digital still camera battery consumption (extract):

When using a battery, use the battery supplied with the camera. The storage media should be **xD-Picture Card**.

Pictures should be taken at a temperature of +23°C (+73°F), with the LCD monitor turned on, the optical zoom moved from full wide-angle to full telephoto (or vice-versa) and back again to its original position every 30 seconds, the flash used at full power every second shot and the camera turned off and then on again once every 10 shots.

- **Note:** Because the number of available shots varies depending on the level of charge in the battery, the figures shown here for the number of available shots using the battery is not guaranteed. The number of available shots will also decline at low temperatures.

**Camera dimensions** 97.7 mm × 58.9 mm × 23.4 mm/3.8 in. × 2.3 in. × 0.9 in., excluding batteries and accessories**(W × H × D)****Camera weight** Approx. 175 g/6.2 oz., excluding batteries, accessories, and memory cards**Shooting weight** Approx. 194 g/6.8 oz., including batteries and memory card**Operating conditions** Temperature: 0°C to +40°C (+32°F to +104°F)  
80% humidity or less (no condensation)

NP-50 rechargeable battery	
<b>Nominal voltage</b>	DC 3.6V
<b>Nominal capacity</b>	1000 mAh
<b>Operating temperature</b>	0°C – +40°C/+32°F – +104°F
<b>Dimensions (W × H × D)</b>	35.4 mm × 40.0 mm × 6.6 mm/1.4 in. × 1.6 in. × 0.3 in.
<b>Weight</b>	Approx. 18 g/0.6 oz.
BC-45W battery charger	
<b>Rated input</b>	100V–240V AC, 50/60 Hz
<b>Input capacity</b>	8.0 VA (100V) 12 VA (240V)
<b>Rated output</b>	4.2V DC, 550 mA
<b>Supported batteries</b>	NP-50 rechargeable batteries
<b>Charging time</b>	Approx. 150 minutes
<b>Dimensions (W × H × D)</b>	91 mm × 62 mm × 23 mm/3.6 in. × 2.4 in. × 0.9 in.
<b>Weight</b>	Approx. 67 g/2.4 oz., excluding battery
<b>Operating temperature</b>	0°C – +40°C/+32°F – +104°F

The weight and dimensions vary with the country or region of sale.

## Color Television Systems

NTSC (National Television System Committee) is a color television telecasting specification adopted mainly in the U.S.A., Canada, and Japan. PAL (Phase Alternation by Line) is a color television system adopted mainly in European countries and China.

## Notices

- Specifications subject to change without notice. FUJIFILM shall not be held liable for damages resulting from errors in this manual.
- Although the monitor is manufactured using advanced high-precision technology, small bright points and anomalous colors (particularly in the vicinity of text) may appear. This is normal for this type of monitor and does not indicate a malfunction; images recorded with the camera are unaffected.
- Digital cameras may malfunction when exposed to strong radio interference (e.g., electric fields, static electricity, or line noise).
- Due to the type of lens used, some distortion may occur at the periphery of images. This is normal.

## FUJIFILM Digital Camera Worldwide Network

Contact your local distributor (see list below) for repairs and technical support. Please present the warranty and purchase receipt when requesting repairs; refer to the warranty card for the conditions of the warranty. Technical support may not be available for models not handled by the local distributor. The following information is subject to change without notice.

NORTH AMERICA			
Canada	<b>FUJIFILM Canada Inc.</b>	Technical support	TEL 1-866-818-FUJI (3854) <a href="http://www.fujihelp.ca">http://www.fujihelp.ca</a>
		Repair service	TEL 1-800-263-5018 <a href="http://www.fujihelp.ca">http://www.fujihelp.ca</a>
U.S.A.	<b>FUJIFILM U.S.A., Inc.</b>	Technical support	TEL 800-800-3854 <a href="mailto:digitalinfo@fujifilm.com">digitalinfo@fujifilm.com</a>
		Repair service	TEL 800-659-3854
CENTRAL AND SOUTH AMERICA			
Argentina	<b>Imagen e informacion S.A.</b>	Technical support & repairs	TEL +54-11-4836-1000 <a href="mailto:servtec@imagineinformacion.com.ar">servtec@imagineinformacion.com.ar</a>
Bolivia	<b>Reifschneider Bolivia Ltda.</b>	Technical support & repairs	TEL +591 33 44 1129 <a href="mailto:gciagral@bibosi.scz.entelnet.bo">gciagral@bibosi.scz.entelnet.bo</a>
Brazil	<b>FUJIFILM do Brasil Ltda.</b>	Technical support & repairs	TEL 0800-12-8600 <a href="mailto:camarasdigitais@fujifilm.com.br">camarasdigitais@fujifilm.com.br</a>
Chile	<b>Reifschneider SA</b>	Technical support & repairs	TEL 56-2-6781200 <a href="mailto:serviciotecnico@reifschneider.cl">serviciotecnico@reifschneider.cl</a>
Colombia	<b>Animex de Colombia Ltda.</b>	Technical support & repairs	TEL +57 1 338-0299 <a href="mailto:animex@etb.net.co">animex@etb.net.co</a>
Ecuador	<b>Espacri Cia Ltda</b>	Technical support & repairs	TEL 593-72-835526
		<b>Importaciones Espacri Cia. Ltda.</b>	Technical support & repairs
Mexico	<b>Fujifilm de Mexico, S.A. de C.V.</b>	Technical support	TEL (52-55) 5263-55000 <a href="mailto:eizquierdo@fujifilm.com.mx">eizquierdo@fujifilm.com.mx</a>
		Repair service	TEL (52-55) 5366-5150/56/57 <a href="mailto:cpalma@fujifilm.com.mx">cpalma@fujifilm.com.mx</a>
Paraguay	<b>Errece S.R.L.</b>	Technical support & repairs	TEL +595 21 444256 <a href="mailto:jmarbulo@fujifilm.com.py">jmarbulo@fujifilm.com.py</a>
Peru	<b>Procesos de Color S.A.</b>	Technical support & repairs	TEL +51 14 33 5563 <a href="mailto:jalvarado@fujifilm.com.pe">jalvarado@fujifilm.com.pe</a>
Uruguay	<b>Fotocamara S.R.L.</b>	Technical support & repairs	TEL +598-2-9002004 <a href="mailto:fotocam@adinet.com.uy">fotocam@adinet.com.uy</a>
		<b>Kiel S.A.</b>	Technical support & repairs
Venezuela	<b>C. Hellmund &amp; Cia Sa</b>	Technical support & repairs	TEL 0212-2022300 <a href="mailto:hellmund@hellmund.com">hellmund@hellmund.com</a>
EUROPE			
Austria	<b>Fuji Film Oesterreich</b>	Technical support & repairs	TEL 0043 1 6162606/51 or 52 <a href="mailto:kamera.service@fujifilm.at">kamera.service@fujifilm.at</a>
Belgium	<b>Belgian Fuji Agency</b>	Technical support & repairs	TEL 3210242090 <a href="mailto:info@fuji.be">info@fuji.be</a>
Croatia	<b>I&amp;I d.o.o.</b>	Technical support	TEL 38512319060 <a href="mailto:dsaravanja@fujifilm.hr">dsaravanja@fujifilm.hr</a>
		Repair service	TEL 38512316228 <a href="mailto:info@fujifilm.hr">info@fujifilm.hr</a>



**EUROPE**

Cyprus	<b>PMS IMAGING LTD</b>	Technical support & repairs	TEL 35722746746 <a href="mailto:mariosashiotis@fujifilm.com.cy">mariosashiotis@fujifilm.com.cy</a>
	<b>Doros Neophytou CAMERA REPAIRS</b>	Technical support & repairs	TEL 35722314719 <a href="mailto:dorosn@logosnet.cy.net">dorosn@logosnet.cy.net</a>
Czech Republic	<b>Fujifilm Cz., s.r.o.</b>	Technical support	TEL 00420 234 703 411 <a href="mailto:petr.barta@fujifilm.cz">petr.barta@fujifilm.cz</a>
	<b>AWH servis</b>	Repair service	TEL 00420 222 721 525 <a href="mailto:awh@awh.cz">awh@awh.cz</a>
Denmark	<b>Fujifilm Danmark A/S</b>	Technical support & repairs	TEL 0045 45662244 <a href="mailto:fujifilm@fujifilm.dk">fujifilm@fujifilm.dk</a>
Finland	<b>Fuji Finland Oy</b>	Technical support & repairs	TEL +358 9 825951 <a href="http://www.fuji.fi">www.fuji.fi</a> <a href="mailto:fuji@fuji.fi">fuji@fuji.fi</a>
France	<b>FUJIFILM France</b>	Technical support & repairs	<a href="mailto:direction.technique@pm2s.fr">direction.technique@pm2s.fr</a>
Germany	<b>FUJIFILM Electronic Imaging Europe GmbH</b>	Technical support & repairs	Tel 0180 / 589 89 80* <a href="mailto:service@fujifilm-digital.com">service@fujifilm-digital.com</a> *0,14 EUR pro Minute aus dem deutschen Festnetz, abweichende Preise aus Mobilfunknetzen möglich, Stand bei Drucklegung.
Greece	<b>FUJIFILM HELLAS S.A.</b>	Technical support & repairs	TEL 0030 210 9404100 <a href="mailto:fujifilm@fujifilm.gr">fujifilm@fujifilm.gr</a>
Hungary	<b>Fujifilm Hungary Ltd.</b>	Technical support	TEL 3612389410 <a href="mailto:fujifilm@fujifilm.hu">fujifilm@fujifilm.hu</a>
		Repair service	TEL 3613633777
Iceland	<b>Icephoto (Ljosmyndavörur)</b>	Technical support & repairs	TEL 354 568 0450 <a href="mailto:framkollun@fujifilm.is">framkollun@fujifilm.is</a>
Italy	<b>FujiFilm Italia S.r.l.</b>	Call center	TEL 039-0267978181 <a href="mailto:info@fujifilm.it">info@fujifilm.it</a>
		Repair service	TEL 039-6058294 FAX 039-6058295
Lithuania	<b>Fujifilm Lithuania</b>	Technical support & repairs	TEL 370-5-2130121 <a href="mailto:info@fujifilm.lt">info@fujifilm.lt</a>
Malta	<b>Ciancio (1913) Co.Ltd.</b>	Technical support & repairs	TEL 0356-21-480500 <a href="mailto:info@fujifilm.com.mt">info@fujifilm.com.mt</a>
Norway	<b>Fujifilm Norge AS</b>	Technical support	TEL 0047-02273 <a href="http://www.fujifilm.no/">http://www.fujifilm.no/</a> <a href="mailto:post@fujifilm.no">mailto:post@fujifilm.no</a>
		Repair service	TEL 0047-55393880 <a href="http://www.camera.no/mailto:service@camera.no">http://www.camera.no/mailto:service@camera.no</a>
		Technical support	TEL +48-22-517-66-00 <a href="mailto:fujifilm@fujifilm.pl">fujifilm@fujifilm.pl</a>
Poland	<b>Fujifilm Polska Distribution Sp. z o.o.</b>	Repair service	TEL +48-22-886-94-40 <a href="mailto:serwis@fujifilm.pl">serwis@fujifilm.pl</a>
Portugal	<b>Fujifilm Portugal, Lda</b>	Technical support	TEL (351) 226 194 237 <a href="mailto:finepix@fujifilm.pt">finepix@fujifilm.pt</a>
		Repair service	TEL (351) 226 194 200 <a href="mailto:cameras@fujifilm.pt">cameras@fujifilm.pt</a>
Romania	<b>CTS-Cardinal Top Systems Ltd</b>	Technical support & repairs	TEL 4021-230-09-82 <a href="mailto:cts_tirla@hotmail.com">cts_tirla@hotmail.com</a>
Russia	<b>Fujifilm Electronic Imaging Europe GmbH</b>	Technical support & repairs	TEL 8 800 200 3854 (Для бесплатных звонков из России) *Для звонков из других стран набирайте +7 800 200 3854 <a href="http://www.fujifilm-digital.ru/">http://www.fujifilm-digital.ru/</a> <a href="mailto:info@fujifilm-digital.ru">info@fujifilm-digital.ru</a>
Slovakia	<b>Fujifilm Slovakia s.r.o.</b>	Technical support	TEL 00421 2 33 595 107 <a href="mailto:fujifilm@fujifilm.sk">fujifilm@fujifilm.sk</a>
		Repair service	TEL 00421 2 33 595 119 <a href="mailto:servis@fujifilm.sk">servis@fujifilm.sk</a>
Spain	<b>Fujifilm Espana S.A.</b>	Technical support & repairs	TEL 902012535 <a href="http://www.fujifilm.es/soporte/">http://www.fujifilm.es/soporte/</a> <a href="mailto:tallersat@fujifilm.es">tallersat@fujifilm.es</a>

**EUROPE**

Sweden	<b>Fujifilm Sverige AB</b>	Technical support Repair service	TEL 46 8 506 141 70 <i>kamera@fujifilm.se</i> TEL 46 8 506 141 00 <i>kameraverkstaden@fujifilm.se</i>
Switzerland / Liechtenstein	<b>Fujifilm (Switzerland) AG</b>	Technical support & repairs	TEL +41 44 855 5154 <i>RepairCenter@fujifilm.ch</i>
The Netherlands	<b>FUJIFILM Electronic Imaging Nederland</b>	Technical support Repair service	TEL +31(0)102812500 <i>helpdesk@fujifilm-digital.nl</i> TEL +31(0)102812520 <i>camerareparaties@fujifilm-digital.nl</i>
Turkey	<b>Fujifilm Turkiye Sinfo A.S.</b>	Technical support Repair service	TEL +90 212 696 5090 <i>csarp@fujifilm.com.tr</i> TEL +90 212 696 5090 <i>servis@fujifilm.com.tr</i>
U.K.	<b>FUJIFILM UK Ltd.</b>	Technical support Repair service	TEL +44 (0)8700 841310 <i>fujitec@fuji.co.uk</i> TEL +44 (0)8700 841314 <i>fujitec@fuji.co.uk</i>
Ukraine	<b>Image Ukraine CJSC</b>	Technical support & repairs	TEL +380-44-4909075 <i>d@fujifilm.ua</i>

**MIDDLE EAST**

Iran	<b>Tehran Fuka Co.</b>	Technical support & repairs	TEL (+98-21)2254810-19 <i>fuka@neda.net</i>
Israel	<b>Shimone Group Ltd.</b>	Technical support Repair service	TEL (+ ) 972 3 9250666 <i>digital@fujifilm.co.il</i> TEL (+ ) 972 3 9250666 <i>khaim@shimone.com</i>
Jordan	<b>Grand Stores Al- Abdali, Amman / Jordan</b>	Technical support & repairs	TEL 009626-4646387 <i>gstores@go.com.jo</i>
Lebanon	<b>Fototek S.A.R.L.</b>	Technical support & repairs	TEL +961 1 252474 <i>fototek@antakiholding.com</i>
Qatar	<b>Techno Blue</b>	Technical support	TEL 00974 44 66 175 <i>prabu@techno-blue.com</i>
Saudi Arabia	<b>Emam Distribution Co. Ltd.</b>	Technical support	TEL 96626978756 <i>service@fujifilm.com.sa</i>
Syria	<b>Film Trading Company</b>	Technical support Repair service	TEL + 963 11 2218049 <i>f.t.c@Net.SY</i> TEL + 963 21 4641903 <i>filmtradin@Net.SY</i>
U.A.E.	<b>Grand Stores</b>	Technical support & repairs	TEL + 971-4-2823700 <i>photography@grandstores.ae</i>
Yemen	<b>Al-Haidary Trading</b>	Technical support Repair service	TEL 00967-1-503980 TEL 00967-1-503977

**AFRICA**

Egypt	<b>Foto Express Egypt</b>	Technical support & repairs	TEL (202) 7762062 <i>fotoegypt@access.com.eg</i>
Kenya	<b>Fuji Kenya Ltd</b>	Repair service	TEL (254-20)4446265-8 <i>info@fujifilm.co.ke</i>
South Africa	<b>Cameratek CC.</b>	Technical support & repairs	TEL +27 11 251 2400 <i>www.cameratek.co.za</i>

**OCEANIA**

Australia	<b>FUJIFILM Australia Pty Ltd</b>	Technical support & repairs	TEL 1800 226 355 <i>digital@fujifilm.com.au</i>
Fiji	<b>Brijjal &amp; Co. Ltd</b>	Technical support & repairs	TEL (679)3304133 <i>kapadia@connect.com.fj</i>
New Caledonia	<b>Phocidis SARL</b>	Technical support & repairs	TEL (00 687) 25-46-35 <i>phocidis@phocidis.nc</i>

**OCEANIA**

New Zealand	<b>Fujifilm NZ Ltd</b>	Technical support & repairs	TEL +64-9-4140400 <a href="mailto:glenn.beaumont@fujifilm.co.nz">glenn.beaumont@fujifilm.co.nz</a>
Papua New Guinea	<b>Oceania PNG Limited</b>	Technical support	TEL +675 3256411 <a href="mailto:oceania@daltron.com.pg">oceania@daltron.com.pg</a>

**ASIA**

Hong Kong	<b>Fuji Photo Products Co., Ltd.</b>	Technical support & repairs	TEL (852)2406 3287 <a href="mailto:rsd@chinahkphoto.com.hk">rsd@chinahkphoto.com.hk</a>
Indonesia	<b>PT. Modern Internasional, Tbk.</b>	Technical support & repairs	TEL +62 021 45867187 <a href="mailto:assd_kmrsrv@modernphoto.co.id">assd_kmrsrv@modernphoto.co.id</a>
Malaysia	<b>FUJIFILM (Malaysia) Sdn. Bhd.</b>	Technical support	TEL 603-55698388 <a href="mailto:technical@fujifilm.com.my">technical@fujifilm.com.my</a>
		Repair service	TEL 603-55698388 <a href="mailto:camera@fujifilm.com.my">camera@fujifilm.com.my</a>
Philippines	<b>YKL Development &amp; Trdg. Corp.</b>	Technical support	TEL 632-7436601~06 <a href="mailto:info@yklcolor.com">info@yklcolor.com</a> <a href="http://digital@yklcolor.com">digital@yklcolor.com</a>
		Repair service	TEL 632-7436601~06 <a href="mailto:techop_services@yklcolor.com">techop_services@yklcolor.com</a>
Singapore	<b>FUJIFILM (Singapore) Pte Ltd</b>	Technical support & repairs	TEL 65-6380 5557 <a href="mailto:service@fujifilm.com.sg">service@fujifilm.com.sg</a>
South Korea	<b>Korea Fujifilm Co., Ltd.</b>	Technical support	TEL +82-2-3282-7363 <a href="mailto:photo@fujifilm.co.kr">photo@fujifilm.co.kr</a>
	<b>Yonsan AS Center (Fujidigital)</b>	Repair service	TEL +82-2-701-1472 <a href="mailto:1bowl@hanmail.net">1bowl@hanmail.net</a>
	<b>Kangnam AS Center (Digitalgallery)</b>	Repair service	TEL +82-2-2203-1472 <a href="mailto:nurijili@hanmail.net">nurijili@hanmail.net</a>
	<b>Busan AS Center (Digital-Sewon)</b>	Repair service	TEL +82-51-806-1472 <a href="mailto:merahan@yahoo.co.kr">merahan@yahoo.co.kr</a>
Taiwan	<b>Hung Chong Corp.</b>	Technical support & repairs	TEL 886-2-6602-8988 <a href="mailto:dah@mail.hungchong.com.tw">dah@mail.hungchong.com.tw</a>
Thailand	<b>FUJIFILM (Thailand) Ltd.</b>	Technical support	TEL +662-2706000 ext. 751,752 <a href="mailto:Dusit_Suriyong@fujifilm.co.th">Dusit_Suriyong@fujifilm.co.th</a> <a href="mailto:yaowarat@fujifilm.co.th">yaowarat@fujifilm.co.th</a>
		Repair service	TEL +662-2706000 ext.761,762 <a href="mailto:warin@fujifilm.co.th">warin@fujifilm.co.th</a>
Vietnam	<b>International Minh Viet Co., Ltd.</b>	Technical support & repairs	TEL +84-8-4135740 ext. 322 <a href="mailto:diep.phanhitthanh@imv.com.vn">diep.phanhitthanh@imv.com.vn</a>

## IMPORTANT NOTICE: Read Before Using the Software

BEFORE OPENING THE CD-ROM PROVIDED BY FUJIFILM CORPORATION, PLEASE READ THIS END USER LICENSE AGREEMENT CAREFULLY. YOU SHOULD USE THE SOFTWARE ON THE CD-ROM ONLY IF YOU CONSENT TO THIS AGREEMENT. BY OPENING THE PACKAGE, YOU ACCEPT AND AGREE TO BE BOUND BY THIS AGREEMENT.

### End User License Agreement

This End User License Agreement ("Agreement") is an agreement between FUJIFILM Corporation ("FUJIFILM") and you, which sets forth the terms and conditions of the license granted for you to use the software provided by FUJIFILM.

The CD-ROM contains third-party software. In case a separate agreement is provided by a third party supplier for its software, the provisions of such separate agreement shall apply to the use of such third party software, prevailing over those of this Agreement.

#### 1. Definitions.

- "Media" means the CD-ROM titled "Software for FinePix" which is provided to you together with this Agreement.
- "Software" means the software which is recorded on Media.
- "Documentation" means the operation manuals of Software and other related written materials which are provided to you together with Media.
- "Product" means Media (including Software) and Documentation collectively.

#### 2. Use of Software.

FUJIFILM grants to you a nontransferable, nonexclusive license:

- to install one copy of Software onto one computer in binary machine executable form;
- to use Software on the computer onto which Software is installed; and
- to make one backup copy of Software.

#### 3. Restrictions.

- You shall not distribute, rent, lease or otherwise transfer all or any part of Software, Media or Documentation to any third party without FUJIFILM's prior written consent. You also shall not sublicense, assign or otherwise transfer all or any part of the rights granted to you by FUJIFILM under this Agreement without FUJIFILM's prior written consent.
- Except as expressly granted by FUJIFILM hereunder, you shall not copy or reproduce all or any part of Software or Documentation.
- You shall not modify, adapt or translate Software or Documentation. You also shall not alter or remove copyright and other proprietary notices that appear on or in Software or Documentation.
- You shall not, or shall not have any third party, reverse-engineer, decompile, or disassemble Software.

#### 4. Ownership.

All copyrights and other proprietary rights to Software and Documentation are owned and retained by FUJIFILM or the third party suppliers as indicated on or in Software or Documentation. Nothing contained herein shall be construed, expressly or implicitly, as transferring or granting any right, license, or title to you other than those explicitly granted under this Agreement.

#### 5. Limited Warranty.

FUJIFILM warrants to you that Media is free from any defect in material and workmanship under normal use for ninety (90) days from the date of your receipt of Media. Should Media not meet the foregoing warranty, FUJIFILM shall replace such defective Media with other Media bearing no defect. FUJIFILM's entire liability and your sole and exclusive remedy with regard to any defect in Media shall be expressly limited to such FUJIFILM's replacement of Media as provided herein.

#### 6. DISCLAIMER OF WARRANTY.

EXCEPT AS PROVIDED IN SECTION 5 HEREIN, FUJIFILM PROVIDES PRODUCT "AS IS" AND WITHOUT WARRANTIES OF ANY KIND, EXPRESS OR IMPLIED. FUJIFILM SHALL MAKE NO WARRANTY, EXPRESS, IMPLIED OR STATUTORY, AS TO ANY OTHER MATTERS, INCLUDING, BUT NOT LIMITED TO NON-INFRINGEMENT OF ANY COPYRIGHT, PATENT, TRADE SECRET, OR ANY OTHER PROPRIETARY RIGHTS OF ANY THIRD PARTY, MERCHANTABILITY, OR FITNESS FOR ANY PARTICULAR PURPOSE.

#### 7. LIMITATION OF LIABILITY.

IN NO EVENT SHALL FUJIFILM HAVE ANY LIABILITY FOR ANY GENERAL, SPECIAL, DIRECT, INDIRECT, CONSEQUENTIAL, INCIDENTAL, OR OTHER DAMAGES (INCLUDING DAMAGES FOR LOSS OF PROFITS OR LOST SAVINGS) INCURRED FROM THE USE OF OR INABILITY TO USE PRODUCT EVEN IF FUJIFILM HAS BEEN ADVISED OF THE POSSIBILITY OF SUCH DAMAGES.

#### 8. No export.

You acknowledge that neither Software nor any part thereof, will be transferred, or exported to any country or used in any manner in violation of any export control laws and regulations to which Software is subject.

#### 9. Termination.

In case you breach any of the terms and conditions hereof, FUJIFILM may immediately terminate this Agreement without any notice.

#### 10. Term.

This Agreement is effective until the date when you cease to use Software, unless earlier terminated in accordance with Section 9 hereof.

#### 11. Obligation upon termination.

Upon termination or expiration of this Agreement, you shall, at your own responsibility and expense, delete or destroy immediately all Software (including its copies, Media and Documentation).

#### 12. Governing Law.

This Agreement shall be governed by and construed in accordance with laws of Japan.

# FUJIFILM

FUJIFILM Corporation

7-3, AKASAKA 9-CHOME, MINATO-KU, TOKYO 107-0052, JAPAN

[http://www.fujifilm.com/products/digital\\_cameras/index.html](http://www.fujifilm.com/products/digital_cameras/index.html)