

FUJIFILM

DIGITAL CAMERA

FINEPIX J100
FINEPIX J120
FINEPIX J110w
FINEPIX J150w

Owner's Manual

Thank you for your purchase of this product. This manual describes how to use your FUJIFILM FinePix J100, J110w, J120, or J150w digital camera and the supplied software. Be sure that you have read and understood its contents before using the camera.

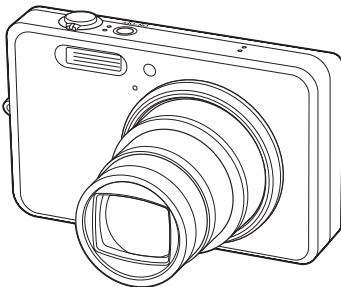

For information on related products, visit our website at <http://www.fujifilm.com/products/index.html>

Exif Print



BL00811-200(1) **E**

Before You Begin

First Steps

Basic Photography and Playback

More on Photography

More on Playback

Movies

Connections

Menus

Technical Notes

Troubleshooting

Appendix

IMPORTANT SAFETY INSTRUCTIONS

- **Read Instructions:** All the safety and operating instructions should be read before the appliance is operated.
- **Retain Instructions:** The safety and operating instructions should be retained for future reference.
- **Heed Warnings:** All warnings on the appliance and in the operating instructions should be adhered to.
- **Follow Instructions:** All operating and use instructions should be followed.

Installation

Power Sources: This video product should be operated only from the type of power source indicated on the marking label. If you are not sure of the type of power supply to your home, consult your appliance dealer or local power company. For video products intended to operate from battery power, or other sources, refer to the operating instructions.

Grounding or Polarization: This video product is equipped with a polarized alternating-current line plug (a plug having one blade wider than the other). This plug will fit into the power outlet only one way. This is a safety feature. If you are unable to insert the plug fully into the outlet, try reversing the plug. If the plug should still fail to fit, contact your electrician to replace your obsolete outlet. Do not defeat the safety purpose of the polarized plug.

Alternate Warnings: This video product is equipped with a three-wire grounding-type plug, a plug having a third (grounding) pin. This plug will only fit into a grounding-type power outlet. This is a safety feature. If you are unable to insert the plug into the outlet, contact your electrician to replace your obsolete outlet. Do not defeat the safety purpose of the grounding type plug.

Overloading: Do not overload wall outlets and extension cords as this can result in a risk of fire or electric shock.

Ventilation: Slots and openings in the cabinet are provided for ventilation, to ensure reliable operation of the video product and to protect it from overheating, and these openings must not be blocked or covered. The openings should never be blocked by placing the video product on a bed, sofa, rug, or other similar surface.

This video product should not be placed in a built-in installation such as a bookcase or rack unless proper ventilation is provided or the manufacturer's instructions have been adhered to. This video product should never be placed near or over a radiator or heat register.

Attachments: Do not use attachments not recommended by the video product manufacturer as they may cause hazards.

Water and Moisture: Do not use this video product near water—for example, near a bath tub, wash bowl, kitchen sink, or laundry tub, in a wet basement, or near a swimming pool, and the like.

Power-Cord Protection: Power-supply cords should be routed so that they are not likely to be walked on or pinched by items placed upon or against them, paying particular attention to cords at plugs, convenience receptacles, and the point where they exit from the appliance.

Accessories: Do not place this video product on an unstable cart, stand, tripod, bracket, or table. The video product may fall, causing serious injury to a child or adult, and serious damage to the appliance. Use only with a cart, stand, tripod, bracket, or table recommended by the manufacturer, or sold with the video product. Any mounting of the appliance should follow the manufacturer's instructions, and should use a mounting accessory recommended by the manufacturer.

An appliance and cart combination should be moved with care. Quick stops, excessive force, and uneven surfaces may cause the appliance and cart combination to overturn.



Antennas

Outdoor Antenna Grounding: If an outside antenna or cable system is connected to the video product, be sure the antenna or cable system is grounded so as to provide some protection against voltage surges and built-up static charges. Section 810 of the National Electrical Code, ANSI/NFPA No. 70, provides information with respect to proper grounding of the mast and supporting structure, grounding of the lead-in wire to an antenna discharge unit, size of grounding conductors, location of antenna discharge unit, connection to grounding electrodes, and requirements for the grounding electrode.

EXAMPLE OF ANTENNA GROUNDING AS PER NATIONAL ELECTRICAL CODE

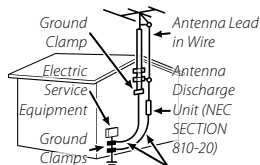

Power Service Grounding Electrode System (NEC ART 250, PART H)

Grounding Conductors (NEC SECTION 810-21)

Power Lines: An outside antenna system should not be located in the vicinity of overhead power lines or

other electric light or power circuits, or where it can fall into such power lines or circuits. When installing an outside antenna system, extreme care should be taken to keep from touching such power lines or circuits as contact with them might be fatal.

Use

Cleaning: Unplug this video product from the wall outlet before cleaning. Do not use liquid cleaners or aerosol cleaners. Use a damp cloth for cleaning.

Object and Liquid Entry: Never push objects of any kind into this video product through openings as they may touch dangerous voltage points or short out parts that could result in a fire or electric shock. Never spill liquid of any kind on the video product.

Lightning: For added protection for this video product receiver during a lightning storm, or when it is left unattended and unused for long periods of time, unplug it from the wall outlet and disconnect the antenna or cable system. This will prevent damage to the video product due to lightning and power-line surges.

Service

Servicing: Do not attempt to service this video product yourself as opening or removing covers may expose you to dangerous voltage or other hazards. Refer all servicing to qualified service personnel.

Damage Requiring Service: Unplug this video product from the wall outlet and refer servicing to qualified service personnel under the following conditions:

- When the power-supply cord or plug is damaged.
 - If liquid has been spilled, or objects have fallen into the video product.
 - If the video product has been exposed to rain or water.
 - If the video product has been dropped or the cabinet has been damaged.
- If the video product does not operate normally follow the operating instructions. Adjust only those controls that are covered by the operating instructions as an improper adjustment of other controls may result in damage and will often require extensive work by a qualified technician to restore the video product to its normal operation.

When the video product exhibits a distinct change in performance—this indicates a need for service.

Replacement Parts: When replacement parts are required, be sure the service technician has used replacement parts specified by the manufacturer or have the same characteristics as the original part. Unauthorized substitutions may result in fire, electric shock or other hazards.

Safety Check: Upon completion of any service or repairs to this video product, ask the service technician to perform safety checks to determine that the video product is in proper operating condition.

Be sure to read these notes before use

Safety Notes

- Make sure that you use your camera correctly. Read these safety notes and your *Owner's Manual* carefully before use.
- After reading these safety notes, store them in a safe place.

About the Icons

The icons shown below are used in this document to indicate the severity of the injury or damage that can result if the information indicated by the icon is ignored and the product is used incorrectly as a result.



WARNING

This icon indicates that death or serious injury can result if the information is ignored.



CAUTION

This icon indicates that personal injury or material damage can result if the information is ignored.

The icons shown below are used to indicate the nature of the instructions which are to be observed.



Triangular icons tell you that this information requires attention ("Important").



Circular icons with a diagonal bar tell you that the action indicated is prohibited ("Prohibited").



Filled circles with an exclamation mark indicate an action that must be performed ("Required").

WARNING



Unplug from power socket

If a problem arises, turn the camera off, remove the battery, and disconnect and unplug the AC power adapter. Continued use of the camera when it is emitting smoke, is emitting any unusual odor, or is in any other abnormal state can cause a fire or electric shock. Contact your FUJIFILM dealer.



Do not allow water or foreign objects to enter the camera. If water or foreign objects get inside the camera, turn the camera off, remove the battery and disconnect and unplug the AC power adapter. Continued use of the camera can cause a fire or electric shock. Contact your FUJIFILM dealer.

! WARNING

Do not use in the bathroom or shower

Do not use the camera in the bathroom or shower. This can cause a fire or electric shock.



Do not disassemble

Never attempt to change or take apart the camera. (Never open the casing.) Do not use the camera when it has been dropped or the casing is damaged. This can cause a fire or electric shock. Contact your FUJIFILM dealer.



Do not change, heat or unduly twist or pull the connection cord and do not place heavy objects on the connection cord. These actions could damage the cord and cause a fire or electric shock. If the cord is damaged, contact your FUJIFILM dealer.



Do not place the camera on an unstable surface. This can cause the camera to fall or tip over and cause injury.



Never attempt to take pictures while in motion. Do not use the camera while you are walking or driving a vehicle. This can result in you falling down or being involved in a traffic accident.



Do not touch any metal parts of the camera during a thunderstorm. This can cause an electric shock due to induced current from the lightning discharge.



Do not use the battery except as specified. Load the battery as shown by the indicator.



Do not heat, change or take apart the battery. Do not drop or subject the battery to impacts. Do not store the battery with metallic products. Do not use chargers other than the specified model to charge the battery. Any of these actions can cause the battery to burst or leak and cause fire or injury as a result.



Use only the battery or AC power adapters specified for use with this camera. Do not use voltages other than the power supply voltage shown. The use of other power sources can cause a fire.



If the battery leaks and fluid gets in contact with your eyes, skin or clothing, flush the affected area with clean water and seek medical attention or call an emergency number right away.



Do not use the charger to charge batteries other than those specified here. The supplied BC-45A battery charger is for use with FUJIFILM NP-45 rechargeable batteries only. Using the charger to charge conventional batteries or other types of rechargeable batteries can cause the battery to leak fluid, overheat or burst.



When carrying the battery, install it in a digital camera or keep it in the hard case. When storing the battery, keep it in the hard case. When discarding, cover the battery terminals with insulation tape. Contact with other metallic objects or battery could cause the battery to ignite or burst.

! WARNING

Keep memory cards out of the reach of small children. Because memory cards are small, they can be swallowed by children. Be sure to store memory cards out of the reach of small children. If a child swallows a memory card, seek medical attention or call an emergency number.

! CAUTION

Do not use this camera in locations affected by oil fumes, steam, humidity or dust. This can cause a fire or electric shock.



Do not leave this camera in places subject to extremely high temperatures. Do not leave the camera in locations such as a sealed vehicle or in direct sunlight. This can cause a fire.



Keep out of the reach of small children. This product could cause injury in the hands of a child.



Do not place heavy objects on the camera. This can cause the heavy object to tip over or fall and cause injury.



Do not move the camera while the AC power adapter is still connected. Do not pull on the connection cord to disconnect the AC power adapter. This can damage the power cord or cables and cause a fire or electric shock.



Do not use the AC power adapter when the plug is damaged or the plug socket connection is loose. This could cause a fire or electric shock.



Do not cover or wrap the camera or the AC power adapter in a cloth or blanket. This can cause heat to build up and distort the casing or cause a fire.



When you are cleaning the camera or you do not plan to use the camera for an extended period, remove the battery and disconnect and unplug the AC power adapter. Failure to do so can cause a fire or electric shock.



When charging ends, unplug the charger from the power socket. Leaving the charger plugged into the power socket can cause a fire.



Using a flash too close to a person's eyes may temporarily affect the eyesight. Take particular care when photographing infants and young children.



When a memory card is removed, the card could come out of the slot too quickly. Use your finger to hold it and gently release the card.



Request regular internal testing and cleaning for your camera. Build-up of dust in your camera can cause a fire or electric shock. Contact your FUJIFILM dealer to request internal cleaning every two years. Please note that this service is not free of charge.

The Battery and Power Supply

The following describes the proper use of the battery and how to prolong its life. Incorrect use can shorten battery life or cause leakage, overheating, fire, or explosion.

The battery is not charged at shipment. Charge the battery before use. Keep the battery in its case when not in use.

Notes on the Battery

The battery gradually loses its charge when not in use. Charge the battery one or two days before use.

Battery life can be extended by turning the camera off when not in use.

Battery capacity decreases at low temperatures; a depleted battery may not function at when cold. Keep a fully charged spare battery in a warm place and exchange as necessary, or keep the battery in your pocket or other warm place and insert it in the camera only when shooting. Do not place the battery in direct contact with hand warmers or other heating devices.

Charging the Battery

Charge the battery in the supplied battery charger (pg. 5). Charging times will increase at ambient temperatures below +10°C (+50°F) or above +35°C (+95°F). Do not attempt to charge the battery at temperatures above 40°C (+104°F); at temperatures below 0°C (+32°F), the battery will not charge.

Do not attempt to recharge a fully charged battery. The battery does not however need to be fully discharged before charging.

The battery may be warm to the touch immediately after charging or use. This is normal.

Battery Life

At normal temperatures, the battery can be recharged about 300 times. A noticeable decrease in the length of time the battery will hold a charge indicates that it has reached the end of its service life and should be replaced.

Storage

Performance may be impaired if the battery is left unused for extended periods when fully charged. Run the battery flat before storing it.

If the camera will not be used for an extended period, remove the battery and store it in a dry place with an ambient temperature of from +15°C to +25°C (+59°F to +77°F). Do not store in locations exposed to extremes of temperature.

Cautions: Handling the Battery

- Do not transport or store with metal objects such as necklaces or hairpins.
- Do not expose to flame or heat.
- Do not disassemble or modify.
- Use with designated chargers only.
- Dispose of used batteries promptly.

- Do not drop or subject to strong physical shocks.
- Do not expose to water.
- Keep the terminals clean.
- The battery and camera body may become warm to the touch after extended use. This is normal.

AC Adapters (Available Separately)

Use only FUJIFILM AC adapters designated for use with this camera. Other adapters could damage the camera.

- The AC adapter is for indoor use only.
- Be sure the DC plug is securely connected to the camera.
- Turn the camera off before disconnecting the adapter. Disconnect the adapter by the plug, not the cable.
- Do not use with other devices.
- Do not disassemble.
- Do not expose to high heat and humidity.
- Do not subject to strong physical shocks.
- The AC adapter may hum or become hot to the touch during use. This is normal.
- If the AC adapter causes radio interference, reorient or relocate the receiving antenna.

Using the Camera

To ensure that images are recorded correctly, do not subject the camera to impact or physical shocks while images are being recorded.

Electrical Interference

This camera may interfere with hospital or aviation equipment. Consult with hospital or airline staff before using the camera in a hospital or on an aircraft.

Liquid Crystal

In the event that the monitor is damaged, care should be taken to avoid contact with liquid crystal. Take the urgent action indicated should any of the following situations arise:

- **If liquid crystal comes in contact with your skin**, clean the area with a cloth and then wash thoroughly with soap and running water.
- **If liquid crystal enters your eyes**, flush the affected eye with clean water for at least 15 minutes and then seek medical assistance.
- **If liquid crystal is swallowed**, rinse your mouth thoroughly with water. Drink large quantities of water and induce vomiting, then seek medical assistance.

Take Test Shots

Before taking photographs on important occasions (such as at weddings or before taking the camera on a trip), take a test shot and view the result in the monitor to ensure that the camera is functioning normally. FUJIFILM Corporation can not accept liability for damages or lost profits incurred as a result of product malfunction.

NOTICES

To prevent fire or shock hazard, do not expose the unit to rain or moisture.

Please read the "Safety Notes" (pages iii–v) and make sure you understand them before using the camera.

Perchlorate Material—special handling may apply. See <http://www.dts.ca.gov/hazardouswaste/perchlorate>.

For Customers in the U.S.A.

Tested To Comply With FCC Standards
FOR HOME OR OFFICE USE

FCC Statement

This device complies with Part 15 of the FCC Rules. Operation is subject to the following two conditions: (1) This device may not cause harmful interference, and (2) this device must accept any interference received, including interference that may cause undesired operation.

CAUTION

This equipment has been tested and found to comply with the limits for a Class B digital device, pursuant to Part 15 of the FCC Rules. These limits are designed to provide reasonable protection against harmful interference in a residential installation. This equipment generates, uses, and can radiate radio frequency energy and, if not installed and used in accordance with the instructions, may cause harmful interference to radio communications. However, there is no guarantee that interference will not occur in a particular installation. If this equipment does cause harmful interference to radio or television reception, which can be determined by turning the equipment off and on, the user is encouraged to try to correct the interference by one or more of the following measures:

- Reorient or relocate the receiving antenna.
 - Increase the separation between the equipment and receiver.
 - Connect the equipment into an outlet on a circuit different from that to which the receiver is connected.
 - Consult the dealer or an experienced radio/TV technician for help.
- You are cautioned that any changes or modifications not expressly approved in this manual could void the user's authority to operate the equipment.

Notes on the Grant

To comply with Part 15 of the FCC Rules, this product must be used with a Fujifilm-specified ferrite-core A/V cable, USB cable, and DC supply cord.

For Customers in Canada

CAUTION: This Class B digital apparatus complies with Canadian ICES-003.

EC Declaration of Conformity

We

Name: FUJIFILM Electronic Imaging Europe GmbH
Address: Benzstrasse 2
47533 Kleve, Germany

declare that the product

Product Name: FUJIFILM DIGITAL CAMERA FinePix J100/
FinePix J110w/FinePix J120/FinePix J150w

Manufacturer's Name: FUJIFILM Corporation
Manufacturer's Address: 7-3, AKASAKA 9-CHOME, MINATO-KU, TOKYO,
107-0052 JAPAN

conforms to the following Standards:

Safety: EN60065: 2002 + A1
EMC: EN55022: 1998 + A1: 2000 + A2: 2003 Class B
EN55024: 1998 + A1: 2001 + A2: 2003
EN61000-3-2: 2000 + A2: 2005
EN61000-3-3: 1995 + A1: 2001 + A2: 2003

following the provision of the EMC Directive (2004/108/EC) and Low Voltage Directive (2006/95/EC).



Kleve, Germany August 1, 2008

Place

Date

Signature, Managing Director

Disposal of Electrical and Electronic Equipment in Private Households**Disposal of used Electrical & Electronic Equipment (Applicable in the European Union, Norway, Iceland and Liechtenstein)**

This symbol on the product, or in the manual and in the warranty, and/or on its packaging indicates that this product shall not be treated as household waste.

Instead it should be taken to an applicable collection point for the recycling of electrical and electronic equipment.



By ensuring this product is disposed of correctly, you will help prevent potential negative consequences to the environment and human health, which could otherwise be caused by inappropriate waste handling of this product.



This symbol on the batteries or accumulators indicates that those batteries shall not be treated as Household waste.

If your equipment contains easy removable batteries or accumulators please dispose these separately according to your local requirements.

The recycling of materials will help to conserve natural resources. For more detailed information about recycling this product, please contact your local city office, your household waste disposal service or the shop where you purchased the product.

In Countries Outside the European Union, Norway, Iceland and Liechtenstein:

If you wish to discard this product including the batteries or accumulators, please contact your local authorities and ask for the correct way of disposal.

Notes on Copyright

Unless intended solely for personal use, images recorded using your digital camera system cannot be used in ways that infringe copyright laws without the consent of the owner. Note that some restrictions apply to the photographing of stage performances, entertainments, and exhibits, even when intended purely for personal use. Users are also asked to note that the transfer of memory cards containing images or data protected under copyright laws is only permissible within the restrictions imposed by those copyright laws.

Trademark Information

xD-Picture Card is a trademark of FUJIFILM Corporation. Macintosh, Power Macintosh, Power Mac, iMac, PowerBook, iBook, and Mac OS are trademarks of Apple Inc. in the U.S.A. and other countries. Microsoft, Windows, the Windows logo, Windows Vista and the Windows Vista logo are trademarks or registered trademarks of Microsoft Corporation in the United States and/or other countries. "Windows" is an abbreviation used in reference to the Microsoft Windows operating system. Adobe and Adobe Reader are either trademarks or registered trademarks of Adobe Systems Incorporated in the U.S.A. and/or other countries. The SDHC logo is a trademark.

Note: The "Designed for Microsoft® Windows® XP" and "CERTIFIED FOR Windows Vista™" logos apply only to the camera and camera hardware driver.

Camera Q & A

Find items by task.

Camera Setup

Question	Key phrase	See page
How do I set the camera clock?	Date and time	13
Can I set the clock to local time when I travel?	Time difference	78
How do I keep the monitor from turning off automatically?	Auto power off	77
How do I stop the camera beeping and clicking?	Operation and shutter volume	73
What are the parts of the camera called?	Parts of the camera	2
What do the icons in the monitor mean?	Monitor	3
How do I use the menus?	Menus	56
What's behind that flashing icon or error message in the monitor?	Messages and displays	88
How much charge is left in the battery?	Battery level	14

Taking Pictures

Question	Key phrase	See page
How many pictures can I take?	Memory capacity	94
Is there a quick and easy way to take snapshots?	 mode	14
How can I make good portraits?	Intelligent Face Detection	19
Is there a simple way to adjust settings for different scenes?	Shooting mode	29
How do I shoot close-ups?	Close-ups (macro mode)	24
How do I keep the flash from firing?	Flash mode	25
How do I stop my subjects' eyes glowing red when I use the flash?		
How do I "fill-in" shadows on back-lit subjects?		
How do I take a group portrait that includes the photographer?	Self-timer mode	27
How do I frame pictures with the subject off to one side?	Focus lock	22
How do I shoot movies?	Recording movies	39

Viewing Pictures

Question	Key phrase	See page
How do I view my pictures?	Single-frame playback	34
How do I get rid of unwanted pictures?	Deleting pictures	18
How do I delete a lot of pictures at once?	Erase	37
Can I zoom in on pictures during playback?	Playback zoom	35
How do I view a lot of pictures at once?	Multi-frame playback	35
How do I view all pictures taken on the same day?	Sort by date	36
Can I protect my pictures from accidental deletion?	Protect	67
Can I hide the icons in the monitor when viewing my pictures?	Choosing a display format	34
How do I view my pictures on TV?	Viewing pictures on TV	42

Sharing Pictures

Question	Key phrase	See page
Can I print pictures on my home printer?	Printing pictures	43
Can I copy my pictures to my computer?	Viewing pictures on a computer	49

Table of Contents

For Your Safety	ii
IMPORTANT SAFETY INSTRUCTIONS	ii
Safety Notes	iii
NOTICES	vi
Camera Q & A	viii
About This Manual	xii

Before You Begin

Introduction	1
Symbols and Conventions	1
Supplied Accessories	1
Parts of the Camera	2
The Monitor	3
The Mode Dial	4



First Steps

Charging the Battery	5
Inserting the Battery	7
Inserting a Memory Card	9
Turning the Camera on and Off	12
Shooting Mode	12
Playback Mode	12
Basic Setup	13

Basic Photography and Playback

Taking Pictures in  (Auto) Mode	14
Viewing Pictures	18

More on Photography

Intelligent Face Detection and Red-Eye Removal	19
Focus Lock	22
 Close-ups (Macro Mode)	24
 Using the Flash	25
 Using the Self-Timer	27
Shooting Mode	29

More on Playback

Playback Options	34
Playback Zoom	35
Multi-Frame Playback	35
Sort by Date	36
 Deleting Pictures	37

Movies

 Recording Movies	39
 Viewing Movies	41

Connections

Viewing Pictures on TV	42
Printing Pictures via USB	43
Connecting the Camera	43
Printing Selected Pictures	43
Printing the DPOF Print Order	44
Creating a DPOF Print Order	46
Viewing Pictures on a Computer	49
Installing FinePixViewer	49
Connecting the Camera	54

Menus	Technical Notes
The Shooting Menu56	Optional Accessories79
Using the Shooting Menu.....56	Accessories for Fujifilm80
Shooting Menu Options.....57	Caring for the Camera81
ISO58	Troubleshooting
QUALITY59	Troubleshooting82
EXP. COMPENSATION60	Warning Messages and Displays88
PHOTOMETRY61	Appendix
WHITE BALANCE61	Glossary92
CONTINUOUS.....62	Flash Mode and Shooting Mode93
The Playback Menu63	Internal Memory/Memory Card Capacity93
Using the Playback Menu63	Specifications95
Playback Menu Options.....64	FUJIFILM Digital Camera Worldwide Network 100
RED EYE REMOVAL.....65	
SLIDE SHOW66	
PROTECT67	
COPY68	
IMAGE ROTATE.....70	
TRIMMING71	
The Setup Menu72	
Using the Setup Menu72	
Setup Menu Options.....73	
IMAGE DISP.74	
FRAME NO.75	
DIGITAL ZOOM76	
LCD POWER SAVE76	
PLAYBACK VOLUME.....76	
LCD BRIGHTNESS.....76	
FORMAT.....77	
AUTO POWER OFF.....77	
TIME DIFFERENCE78	

About This Manual

This manual is for use with the following FinePix cameras: the J100, J110w, J120, and J150w. The J100 and J110w have 2.7-inch monitors and do not support micro-thumbnail playback; the J120 and J150w have 3.0-inch monitors and support 100-frame thumbnail playback (pg. 35). The J100 and J120 are equipped with lenses with a focal length of 35–175 mm (35-mm format equivalent), the J110w and J150w with lenses with a focal length of 28–140 mm (35-mm format equivalent; pg. 95). All other operations are identical; save where otherwise noted, the illustrations in this manual show the J150w. Before using your camera, read this manual and the warnings on pages ii–vii. For information on specific topics, consult the sources below.

✓ **Camera Q & Apg. viii**

Know what you want to do but don't know the name for it? Find the answer in "Camera Q & A."

✓ **Troubleshootingpg. 82**

Having a specific problem with the camera? Find the answer here.

✓ **Glossarypg. 92**

The meanings of some technical terms may be found here.

✓ **Table of Contentspg. x**

The "Table of Contents" gives an overview of the entire manual. The principal camera operations are listed here.

✓ **Warning Messages and Displayspg. 88**

Find out what's behind that flashing icon or error message in the monitor.

Memory Cards

Pictures can be stored in the camera's internal memory or on optional SD and SDHC memory cards. In this manual, SD memory cards are referred to as "memory cards." For more information, see page 9.

Introduction

Symbols and Conventions

The following symbols are used in this manual:

 **Caution:** This information should be read before use to ensure correct operation.

 **Note:** Points to note when using the camera.

 **Tip:** Additional information that may be helpful when using the camera.

Menus and other text in the camera monitor are shown in bold. In the illustrations in this manual, the monitor display may be simplified for explanatory purposes.

Supplied Accessories

The following items are included with the camera:

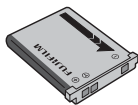

NP-45 rechargeable
battery

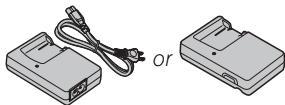

BC-45A battery charger (with
power cable or built-in plug)

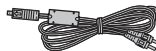

A/V cable

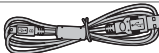

USB cable



FinePix software CD
**(IMPORTANT: read
license agreement
on the last page of
this manual before
opening)**



Strap

Attaching the Strap

Attach the strap as shown.

1

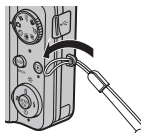

2

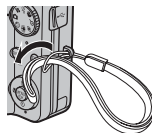

• Owner's Manual
(this manual)

Parts of the Camera

For more information, refer to the page listed to the right of each item.

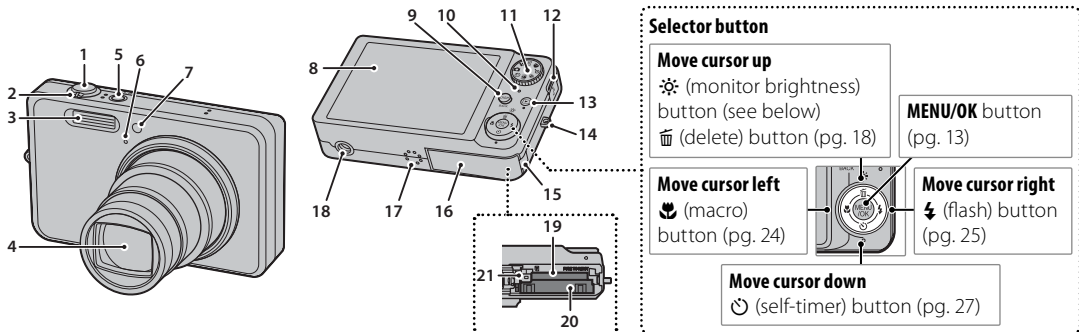

1	Shutter button.....	16–17	9	DISP (display)/ BACK button.....	16, 34	16	Battery-chamber cover.....	7
2	Zoom control.....	15	10	Indicator lamp.....	17	17	Speaker.....	41
3	Flash.....	25	11	Mode dial.....	4	18	Tripod mount	
4	Lens and lens cover.....	12	12	Connector for USB cable.....	43, 54	19	Memory card slot.....	10
5	ON/OFF button.....	12		Connector for A/V cable.....	42	20	Battery chamber.....	7
6	Microphone.....	39	13	▶ (playback) button.....	34	21	Battery latch.....	7
7	Self-timer lamp.....	28	14	Strap eyelet.....	1			
8	Monitor.....	3	15	DC coupler cable cover.....	80			

Monitor Brightness

Pressing the  button briefly increases monitor brightness, making the display easier to see in bright light. Normal brightness is restored when a photograph is taken.

The Monitor

The following indicators may appear in the monitor during shooting and playback:

Shooting

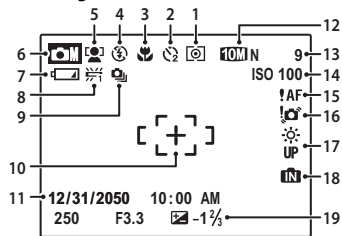

1	Metering	61	11	Date and time.....	13
2	Self timer indicator.....	27	12	Quality.....	39, 59
3	Macro (close-up) mode.....	24	13	Number of exposures remaining.....	94
4	Flash mode.....	25	14	Sensitivity.....	58
5	Intelligent Face Detection indicator.....	19	15	Focus warning	16
6	Shooting mode.....	29	16	Blur warning.....	25
7	Battery level.....	14	17	Bright monitor indicator.....	2
8	White balance	61	18	Internal memory indicator*	9
9	Continuous mode	62	19	Exposure compensation	60
10	Focus frame.....	16			

* Indicates that no memory card is inserted and that pictures will be stored in the camera's internal memory (pg. 9).

Playback

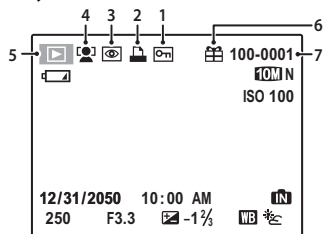

1	Protected image.....	67	5	Playback mode indicator	34
2	DPOF print indicator	46	6	Gift image	34
3	Red-eye removal indicator	65	7	Frame number.....	75
4	Intelligent Face Detection indicator.....	19, 65			

The Mode Dial

To select a shooting mode, align the mode icon with the mark next to the mode dial.

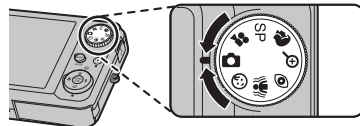



 **(movie)**: Record short movies with sound (pg. 39).

SP (scene position): Choose a scene suited to the subject or shooting conditions and let the camera do the rest (pg. 30).

 **(portrait)**: Use for soft-toned portraits with natural skin tones (pg. 30).

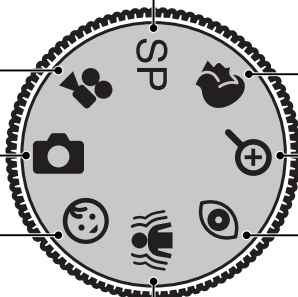
 **(auto)**: A simple “point-and-shoot” mode recommended for first-time users of digital cameras (pg. 14).



 **(digital zoom)**: Increase zoom by up to 3× so that small or distant subjects fill the frame (pg. 30).

 **(baby mode)**: Choose for natural skin tones in portraits of infants. The flash turns off automatically (pg. 29).

 **(anti-blur)**: High shutter speeds reduce blur caused by subject movement or camera shake (pg. 29).

 **(red-eye reduction)**: Reduce “red-eye” in portraits taken with the flash under low light (pg. 29).

Charging the Battery

The battery is not charged at shipment. Charge the battery before use.

1 Place the battery in the charger.

Insert the battery into the supplied BC-45A battery charger as shown, making sure that the battery is in the correct orientation. The BC-45A comes in one of two types, depending on the country or region of sale: one with a built-in plug that plugs directly into the power outlet (A), and another that connects to the power outlet via a power cable (B).

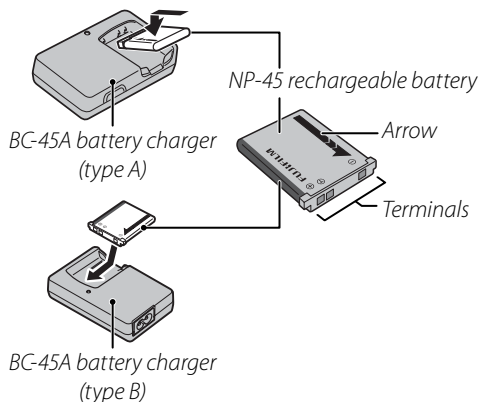

2 Plug the charger in.

Plug the charger into a power outlet. The red charging indicator will light.

Type A

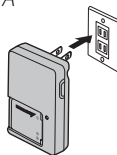

Type B

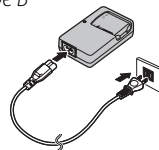

The Charging Indicator

The charging indicator shows battery charge status as follows:

Charging indicator	Battery status	Action
Off	Battery not inserted.	Insert the battery.
	Battery fully charged.	Remove the battery.
Glows red	Battery charging.	—
Blinks red	Battery fault.	Unplug the charger and remove the battery.

3 Charge the battery.

Charging is complete when the charging indicator turns off. A fully exhausted battery takes about 100 minutes to charge.

Cautions: Caring for the Battery

- Do not affix stickers or other objects to the battery. Failure to observe this precaution could make it impossible to remove the battery from the camera.
- Do not short the battery terminals. The battery could overheat.
- Read the cautions on page v.
- Use only NP-45 batteries. Failure to observe this precaution could result in product malfunction.
- Do not remove the labels from the battery or attempt to split or peel the outer casing.
- The battery gradually loses its charge when not in use. Charge the battery one or two days before use.

Cautions: Using the Battery Charger

- Unplug the charger when it is not in use.
- Remove dirt from the battery terminals with a clean, dry cloth. Failure to observe this precaution could prevent the battery from charging.
- Charging times increase at low temperatures.

Inserting the Battery

After charging the battery, insert it in the camera as described below.

1 Open the battery-chamber cover.

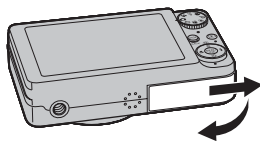

Note

Be sure the camera is off before opening the battery-chamber cover.

Cautions

- Do not open the battery-chamber cover when the camera is on. Failure to observe this precaution could result in damage to image files or memory cards.
- Do not use excessive force when handling the battery-chamber cover.

2 Insert the battery.

Align the orange stripe on the battery with the orange battery latch and slide the battery into the camera, pressing the battery latch in the direction shown below. Confirm that the battery is securely latched.

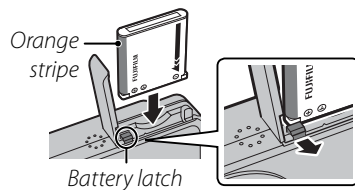
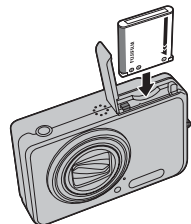

Caution

Insert the battery in the correct orientation. **Do not use force or attempt to insert the battery upside down or backwards.** The camera will not function if the battery is inserted backwards or upside down.

3 Close the battery-chamber cover.

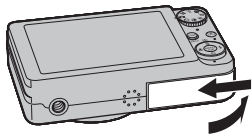

Removing the Battery

After turning the camera off, open the battery-chamber cover, press the battery latch to the top, and slide the battery out of the camera as shown.

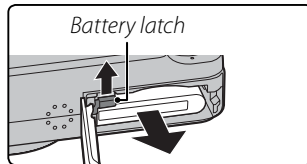

Caution

Turn the camera off before removing the battery.

Tip: Using an AC Adapter

The camera can be powered by an optional AC-5VX AC adapter equipped with a CP-45 DC coupler (available separately). See the AC-5VX and CP-45 manuals for details.

Inserting a Memory Card

Although the camera can store pictures in internal memory, SD memory cards (sold separately) can be used to store additional pictures.

When no memory card is inserted,  appears in the monitor and internal memory is used for recording and playback. Note that because camera malfunction could cause internal memory to become corrupted, the pictures in internal memory should periodically be transferred to a computer and saved on the computer hard disk or on removable media such as CDs or DVDs. The pictures in internal memory can also be copied to a memory card (see page 68). To prevent internal memory from becoming full, be sure to delete pictures when they are no longer needed.

When a memory card is inserted as described below, the card will be used for recording and playback.

■ **Compatible Memory Cards**

SanDisk SD and SDHC memory cards have been tested and approved for use in the camera. A complete list of approved memory cards is available at http://www.fujifilm.com/products/digital_cameras/index.html. Operation is not guaranteed with other cards. The camera can not be used with multimedia or *xD-Picture* cards.

Caution

Memory cards can be locked, making it impossible to format the card or to record or delete images. Before inserting a memory card, slide the write-protect switch to the unlocked position.

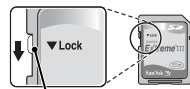

Write-protect
switch

■ Inserting a Memory Card

1 Open the battery-chamber cover.

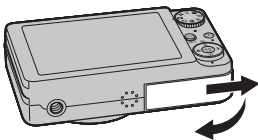

2 Insert the memory card.

Holding the memory card in the orientation shown below, slide it all the way in.

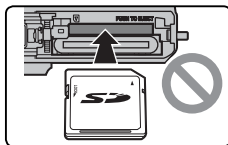
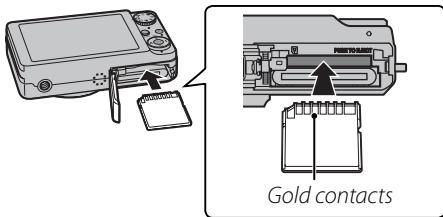

Be sure card is in correct orientation; do not insert at an angle or use force.

3 Close the battery-chamber cover.

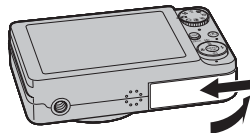

● Removing Memory Cards

Press the card in and then release it slowly. The card can now be removed by hand.

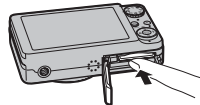

⚠ Cautions

- The memory card may spring out if you remove your finger immediately after pushing the card in.
- Memory cards may be warm to the touch after being removed from the camera. This is normal and does not indicate a malfunction.

⚠ Cautions

- Format memory cards before first use, and be sure to reformat all memory cards after using them in a computer or other device. For more information on formatting memory cards, see page 77.
- Memory cards are small and can be swallowed; keep out of reach of children. If a child swallows a memory card, seek medical assistance immediately.
- Do not use miniSD or microSD adapters that expose the back of the card. Failure to observe this precaution may cause damage or malfunction. Adapters that are larger or smaller than the standard dimensions of an SD card may not eject normally; if the card does not eject, take the camera to an authorized service representative. Do not forcibly remove the card.
- Do not turn the camera off or remove the memory card while the memory card is being formatted or data are being recorded to or deleted from the card. Failure to observe this precaution could damage the card.
- Do not affix labels to memory cards. Peeling labels can cause camera malfunction.
- Movie recording may be interrupted with some types of memory card.
- The data in internal memory may be erased or corrupted when the camera is repaired. Please note that the repairer will be able to view pictures in internal memory.
- Formatting a memory card or internal memory in the camera creates a folder in which pictures are stored. Do not rename or delete this folder or use a computer or other device to edit, delete, or rename image files. Always use the camera to delete pictures from memory cards and internal memory; before editing or renaming files, copy them to a computer and edit or rename the copies, not the originals.

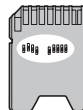

Turning the Camera on and Off

Shooting Mode

Press the **ON/OFF** button to turn the camera on. The lens will extend and the lens cover will open.

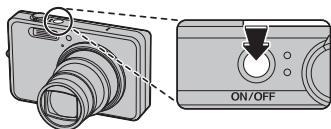

Press **ON/OFF** again to turn the camera off.

Tip: Switching to Playback Mode

Press the **▶** button to start playback. Press the shutter button halfway to return to shooting mode.

Caution

Pictures can be affected by fingerprints and other marks on the lens. Keep the lens clean.

Tip: Auto Power Off

The monitor will dim to save power if no operations are performed for about ten seconds in shooting mode. Full brightness can be restored by operating any of the camera controls. The camera will turn off automatically if no operations are performed for the length of time selected in the **AUTO POWER OFF** menu (see page 77). To turn the camera on, press the **ON/OFF** button or press the **▶** button for about a second.

Playback Mode

To turn the camera on and begin playback, press the **▶** button for about a second.

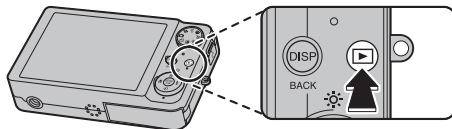

Press the **▶** button again to turn the camera off.

Tip: Switching to Shooting Mode

To exit to shooting mode, press the shutter button halfway. Press the **▶** button to return to playback.

Basic Setup

A language-selection dialog is displayed the first time the camera is turned on. Set up the camera as described below (for information on resetting the clock or changing languages, see page 72).

1 Choose a language.



1.1 Press the selector up, down, left, or right to highlight a language.



1.2 Press **MENU/OK**.



2 Set the date and time.

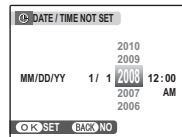

2.1 Press the selector left or right to highlight the year, month, day, hour, or minute and press up or down to change. To change the order in which the year, month, and day are displayed, highlight the date format and press the selector up or down.



2.2 Press **MENU/OK**.



Tip: The Camera Clock

If the battery is removed for an extended period, the camera clock will be reset and the language-selection dialog will be displayed when the camera is turned on. If the battery is left in the camera for about two hours, the battery can be removed for about 24 hours without resetting the clock or language selection.

Taking Pictures in (Auto) Mode

This section describes how to take pictures in  (auto) mode.

- 1 Turn the camera on.**
Press the **ON/OFF** button to turn the camera on.

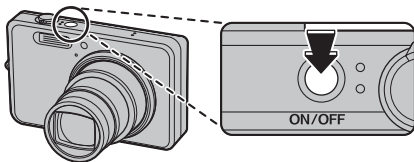

- 2 Select  mode.**
Rotate the mode dial to .

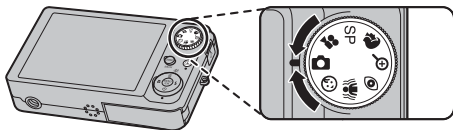

- 3 Check the battery level.**
Check the battery level in the monitor.

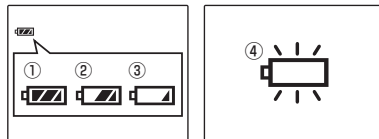

Indicator	Description
① (white)	Battery partially discharged.
② (white)	Battery more than half discharged.
③ (red)	Low battery. Charge as soon as possible.
④ (blinks red)	Battery exhausted. Turn camera off and charge battery.

4 Frame the picture.

Position the main subject in the focus area and use the zoom control to frame the picture in the monitor.

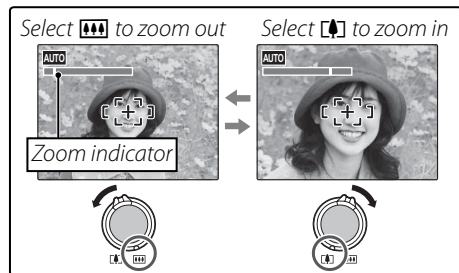

Zoom in up to 5× using optical zoom, or use digital zoom (see below) to zoom in closer.

Holding the Camera

Hold the camera steady with both hands and brace your elbows against your sides. Shaking or unsteady hands can blur your shots.

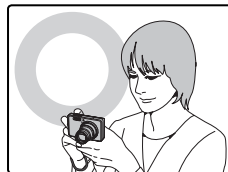

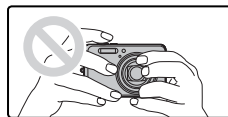

To prevent pictures that are out of focus or too dark (underexposed), keep your fingers and other objects away from the lens and flash.



Tip: Focus Lock

Use focus lock (pg. 22) to focus on subjects that are not in the focus frame.

Tip: Digital Zoom

Digital zoom can be activated by rotating the mode dial to  (pg. 30) or using the  **DIGITAL ZOOM** option in the setup menu (pg. 76).

The Framing Grid

To display a framing grid or to view or hide other indicators in the monitor, press the **DISP/BACK** button.

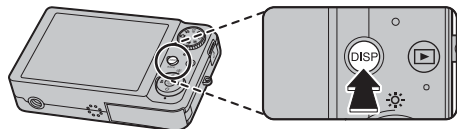

Indicators
displayed



Indicators
hidden



Framing grid
displayed

To use the framing grid, position the main subject at the intersection of two lines or align one of the horizontal lines with the horizon. Use focus lock (pg. 22) to focus on subjects that will not be in the center of the frame in the final photograph.

5 Focus.

Press the shutter button halfway to focus on the main subject in the focus frame.

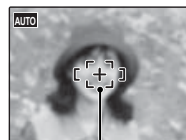

Focus frame

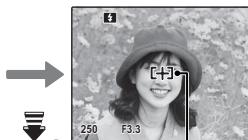

Camera selects small
focus frame and
focuses on subject

 Press
halfway

If the camera is able to focus, it will beep twice and the indicator lamp will glow green.

If the camera is unable to focus, the focus frame will turn red, a **!AF** indicator will appear in the monitor, and the indicator lamp will blink green. Change the composition or use focus lock (pg. 22).

Note

The lens may make a noise when the camera focuses. This is normal.

6 Shoot.

Smoothly press the shutter button the rest of the way down to take the picture.

Tip: The Shutter Button

The shutter button has two positions. Pressing the shutter button halfway (①) sets focus and exposure; to shoot, press the shutter button the rest of the way down (②).

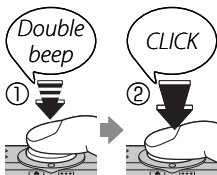

Note

If the subject is poorly lit, the flash may fire when the picture is taken. To take pictures without the flash, choose another flash mode (pg. 25).

The Indicator Lamp

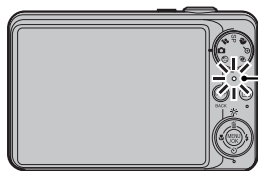

Indicator lamp

The indicator lamp shows camera status as follows:

Indicator lamp	Camera status
Glows green	Focus locked.
Blinks green	Camera unable to focus or picture may be blurred. Picture can be taken.
Blinks green and orange	Recording pictures. Additional pictures can be taken.
Glows orange	Recording pictures. No additional pictures can be taken at this time.
Blinks orange	Flash charging; flash will not fire when picture is taken.
Blinks red	Lens or memory error (internal memory or memory card full or not formatted, format error, or other memory error).

Tip: Warnings

Detailed warnings appear in the monitor. See pages 88–91 for more information.

Viewing Pictures

Pictures can be viewed in the monitor. When taking important photographs, take a test shot and check the results.

- 1 Press the  button.

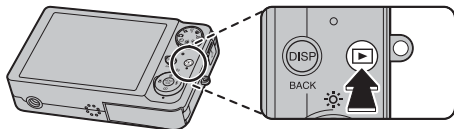

The most recent picture will be displayed in the monitor.



- 2 View additional pictures.

Press the selector right to view pictures in the order recorded, left to view pictures in reverse order.



Press the shutter button to exit to shooting mode.

Deleting Pictures

To delete the picture currently displayed in the monitor, press the selector up () button. The following dialog will be displayed.



To delete the picture, press the selector left to highlight **OK** and press **MENU/OK**. To exit without deleting the picture, highlight **CANCEL** and press **MENU/OK**.



Tip: The Playback Menu

Pictures can also be deleted from the playback menu (pg. 37).

Intelligent Face Detection and Red-Eye Removal

Intelligent Face Detection allows the camera to automatically detect human faces and set focus and exposure for a face anywhere in the frame for shots that emphasize portrait subjects. Choose for group portraits to prevent the camera from focusing on the background. It can be used in tall and wide orientations and is available in , , , , , , , , , , , , , and modes (pp. 29–33). Intelligent Face Detection also offers a red-eye removal option for removing “red-eye” effects caused by the flash.

1 Turn Intelligent Face Detection on.

- 1.1 Press **MENU/OK** to display the shooting menu.

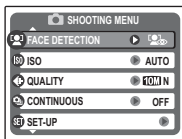

- 1.2 Press the selector up or down to highlight **FACE DETECTION**.



- 1.3 Press the selector right to display Intelligent Face Detection options.



- 1.4 Press the selector up or down to highlight the desired option.



Option	Description
ON	Intelligent Face Detection and red-eye removal on. Use with the flash.
ON	Intelligent Face Detection on; red-eye removal on.
ON OFF	Intelligent Face Detection on; red-eye removal off.
OFF	Intelligent Face Detection and red-eye removal off.

- 1.5 Press **MENU/OK** to select the highlighted option and return to shooting mode.



icon appears in monitor when Intelligent Face Detection is on.



2 Frame the picture.

If a face is detected, it will be indicated by a green border. If there is more than one face in the frame, the camera will select the face closest to the center; other faces are indicated by white borders.





Green border

3 Focus.

Press the shutter button halfway to set focus and exposure for the subject in the green border.



Cautions



- If no face is detected when the shutter button is pressed halfway (pg. 84), the camera will focus on the subject at the center of the monitor and red-eye will not be removed.
- In  and  modes, exposure will be optimized for the entire scene rather than the selected portrait subject.

4 Shoot.

Press the shutter button all the way down to shoot.

Caution

If the subject moves as the shutter button is pressed, their face may not be in the area indicated by the green border when the picture is taken.

If  **ON**/ **ON** is selected, the picture will be processed to reduce red-eye before it is recorded (the  **RED-EYE REMOVAL** option in the playback menu can also be used to reduce red-eye; pg. 65).

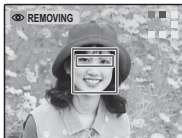

Intelligent Face Detection

Intelligent Face Detection is recommended when using the self-timer for group- or self-portraits (pp. 27–28).



The camera can zoom in on pictures taken with Intelligent Face Detection during slide shows (pg. 66) and when pictures are displayed automatically after shooting (pg. 74).

Focus Lock

To compose photographs with off-center subjects:

1 Position the subject in the focus frame.



2 Focus.

Press the shutter button halfway to set focus and exposure. Focus and exposure will remain locked while the shutter button is pressed halfway (AF/AE lock).



*Press
halfway*



Repeat steps 1 and 2 as desired to refocus before taking the picture.

3 Recompose the picture.

Keeping the shutter button pressed halfway, recompose the picture.



4 Shoot.

Press the shutter-release button the rest of the way down to take the picture.



*Press the rest of
the way down*



















Autofocus

Although the camera boasts a high-precision autofocus system, it may be unable to focus on the subjects listed below. If the camera is unable to focus using autofocus, use focus lock (pg. 22) to focus on another subject at the same distance and then recompose the photograph.

- Very shiny subjects such as mirrors or car bodies.
- Fast-moving subjects.
- Subjects photographed through a window or other reflective object.
- Dark subjects and subjects that absorb rather than reflect light, such as hair or fur.
- Insubstantial subjects, such as smoke or flame.
- Subjects that show little contrast with the background (for example, subjects in clothing that is the same color as the background).
- Subjects positioned in front of or behind a high-contrast object that is also in the focus frame (for example, a subject photographed against a backdrop of highly contrasting elements).



Close-ups (Macro Mode)

Macro mode can be used for close-ups in , , , , , , , , and  modes (pp. 29–33). Macro mode is automatically selected in  and  modes; to select macro mode in , , , , , , and  modes, press the selector left ().

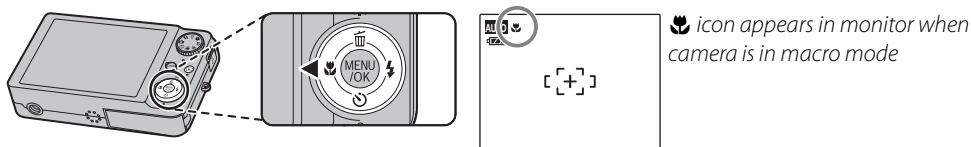

When macro mode is in effect, the camera focuses on subjects near the center of the monitor. Use the zoom control to frame pictures.

To exit macro mode, press the selector left (). Macro mode can also be cancelled by turning the camera off or selecting another shooting mode.

Note



Use of a tripod is recommended to prevent blur caused by camera shake.

⚡ Using the Flash

Use the flash when lighting is poor, for example when shooting at night or indoors under low light.

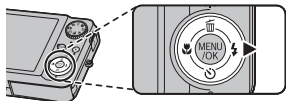
To choose a flash mode, press the selector right (⚡). The flash mode changes each time the selector is pressed; in modes other than AUTO, the current mode is indicated by an icon in the monitor. Choose from the following options (some options are not available in all shooting modes; see pg. 93):









Mode	Description
AUTO (no icon)	The flash fires when required. Recommended in most situations.
⚡ (fill flash)	The flash fires whenever a picture is taken. Use for backlit subjects or for natural coloration when shooting in bright light.
⊖ (flash off)	The flash does not fire even when the subject is poorly lit.  will appear in the monitor at slow shutter speeds to warn that pictures may be blurred. Use of a tripod is recommended.
⚡ (slow sync)	Capture both the main subject and the background when shooting at night (note that brightly lit scenes may be overexposed). If  is selected for SCENE POSITION , shutter speed may be as slow as 4s. Use a tripod.

If the flash will fire,  will be displayed in the monitor when the shutter button is pressed halfway.

Caution

The flash may fire several times with each shot. Do not move the camera until shooting is complete.

Red-Eye Removal

When  ON/ ON is selected for Intelligent Face Detection (pg. 19), red-eye removal () is available in AUTO (), fill flash (), and slow sync () modes. Red-eye removal minimizes “red-eye” caused when light from the flash is reflected from the subject’s retinas as shown in the illustration at right.



⌚ Using the Self-Timer

The camera offers a ten-second timer that allows photographers to appear in their own photographs, and a two-second timer that can be used to avoid blur caused by the camera moving when the shutter button is pressed. The self-timer is available in all shooting modes.

1 Set the timer.

The current self-timer mode is displayed in the monitor. To choose a different setting, press the selector down (⌚). The selection changes each time the selector is pressed.

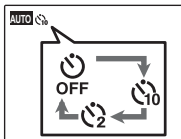
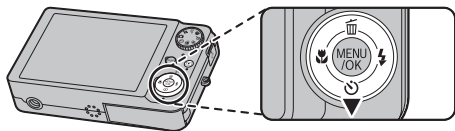

Choose from (self-timer off), (10 s delay), or (2 s delay)

2 Focus.

Press the shutter button halfway to focus.

Caution

Stand behind the camera when using the shutter button. Standing in front of the lens can interfere with focus and exposure.



3 Start the timer.

Press the shutter button the rest of the way down to start the timer. The display in the monitor shows the number of seconds remaining until the shutter is released. To stop the timer before the picture is taken, press **DISP/BACK**.

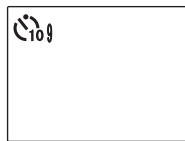

The self-timer lamp on the front of the camera will blink immediately before the picture is taken. If the two-second timer is selected, the self-timer lamp will blink as the timer counts down.

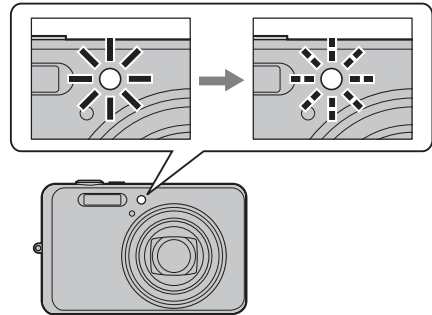

●● Intelligent Face Detection

Because it ensures that the faces of portrait subjects will be in focus, Intelligent Face Detection (pg. 19) is recommended when using the self-timer for group portraits or self-portraits. To use the self-timer with Intelligent Face Detection, set the timer as described in Step 1 and then press the shutter button all the way down to start the timer. The camera will detect faces while the timer is counting down and adjust focus and exposure immediately before the shutter is released. Be careful not to move until the picture has been recorded.

⬅ Note

The self-timer turns off automatically when the picture is taken, a different shooting mode is selected, playback mode is selected, or the camera is turned off.

Shooting Mode

Choose a shooting mode according to the scene or type of subject. To choose a shooting mode, rotate the mode dial to the desired setting. The following modes are available:

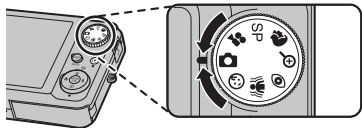

Auto

Choose for crisp, clear snapshots (pg. 14). This mode is recommended in most situations.

Baby Mode

Choose for natural skin tones when taking portraits of infants. The flash turns off automatically.



Anti-Blur (Picture Stabilization)

Choose this mode for fast shutter speeds that reduce blur caused by camera shake or subject movement.

Red-Eye Reduction

Reduce red-eye in portraits taken with the flash under low light (pg. 26).

Note

In modes other than  (pg. 31),  ISO is fixed at **AUTO** (pg. 58). See page 93 for restrictions on flash mode settings.

Digital Zoom

Choose for more powerful zoom when framing small or distant objects. Digital zoom is fixed at 3× and optical zoom can be adjusted using the zoom control to zoom in up to a further 5×, for a combined zoom of up to 15×.

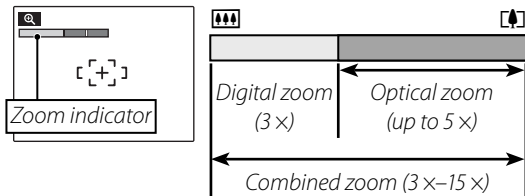

Caution

Digital zoom produces lower quality images than optical zoom.

Tip: **DIGITAL ZOOM**

The  **DIGITAL ZOOM** option in the setup menu can be used to enable digital zoom in other shooting modes. This option also allows digital zoom to be adjusted using the zoom control.

PORTRAIT

Choose this mode for soft-toned portraits with natural skin tones.



SP Scene Position

Your choice of 13 “scenes,” each adapted to particular shooting conditions or a specific type of subject, can be assigned to the **SP** position on the mode dial:

1 Rotate the mode dial to **SP**.



2 Press **MENU/OK** to display the shooting menu.

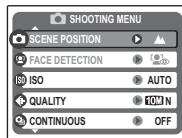

- 3 Press the selector up or down to highlight  **SCENE POSITION**.



- 4 Press the selector right to display a list of scenes.

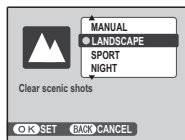

- 5 Press the selector up or down to highlight a scene (pp. 31–33).



- 6 Press **MENU/OK** to select the highlighted option.



Until the setting is changed as described above, the chosen scene will be selected whenever the mode dial is rotated to **SP**. The default selection is .

MANUAL

Choose this mode for complete control of shooting settings, including sensitivity (pg. 58), exposure compensation (pg. 60), metering (pg. 61), quality (pg. 59), and white balance (pg. 61).

LANDSCAPE

Choose this mode for crisp, clear daylight shots of buildings and landscapes. The flash turns off automatically.



SPORT

Choose this mode when photographing moving subjects. Priority is given to faster shutter speeds.



NIGHT

Shutter speeds as slow as 3 s are used to record night and twilight scenes. Use of a tripod is recommended to prevent camera shake.

**NATURAL LIGHT**

Capture natural light indoors, under low light, or where the flash can not be used. The flash turns off and sensitivity is raised to reduce blur.

**BEACH**

Choose for crisp, clear shots that capture the brightness of sunlit beaches.

**SNOW**

Choose for crisp, clear shots that capture the brightness of scenes dominated by shining white snow.

**FIREWORKS**

Slow shutter speeds are used to capture the expanding burst of light from a firework. Press the selector left or right to choose from shutter speeds between 8 s and ½ s. Use of a tripod is recommended to prevent blur. The flash turns off automatically.



SUNSET

Choose this mode to record the vivid colors in sunrises and sunsets.

*** FLOWER**

Choose for vivid close-ups of flowers. The camera focuses in the macro range and the flash turns off automatically.

**🍷 PARTY**

Capture indoor background lighting under low-light conditions.

**OFF MUSEUM**

Choose where flash photography is prohibited or the sound of the shutter may be unwelcome. The flash, speaker, and self-timer lamp turn off automatically.

**← Note**

Photography may be prohibited altogether in some settings. Obtain permission before shooting.

TEXT TEXT

Take clear pictures of text or drawings in print. The camera focuses in the macro range.

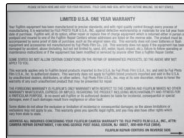

Playback Options

To view the most recent picture in the monitor, press the  button.

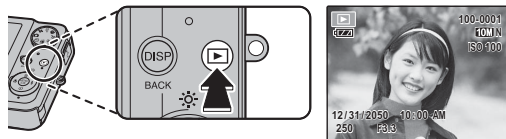

Press the selector right to view pictures in the order recorded, left to view pictures in reverse order.



To scroll rapidly through your pictures, press and hold the selector. The pictures on the memory card will be displayed as small thumbnail images with the current picture highlighted. Release the selector to view the highlighted picture full screen.



Choosing a Display Format

Press the **DISP/BACK** button to cycle through playback display formats as shown below.

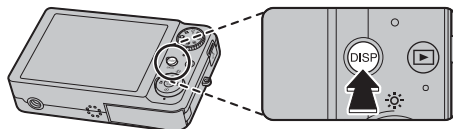

Indicators displayed

Indicators hidden





Sort by date

Note

Pictures taken using other cameras are indicated by a  ("gift image") icon during playback.

Playback Zoom

Select  to zoom in the picture currently displayed full frame in the monitor; select  to zoom out. When the picture is zoomed in, the selector can be used to view areas of the image not currently visible in the display.

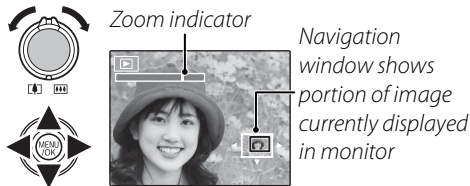

Press **DISP/BACK** to exit zoom.

← Note

The maximum zoom ratio varies with image size. Playback zoom is not available with pictures taken at an image size of **03M**.

Multi-Frame Playback

To change the number of images displayed, select  when a picture is shown full-frame in the monitor.

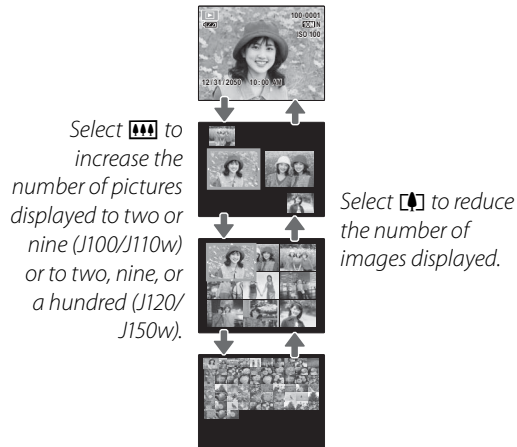

Use the selector to highlight images and press **MENU/OK** to view the highlighted image full frame. In the nine- and hundred-frame displays, press the selector up or down to view more pictures.

Sort by Date

Choose sort-by-date mode to view pictures taken on a selected date.

- 1** Press **DISP/BACK** until the sort-by-date screen is displayed.



- 2** Use the selector to highlight the arrow (←) at the top left corner of the display.



- 3** Press the selector left to highlight the date.



- 4** Press the selector up or down to select a date.



- 5** Press the selector right to return to the sort-by-date display.



- 6** Use the selector to highlight images and press **MENU/OK** to view the highlighted image full frame.



Deleting Pictures

The **ERASE** option in the playback menu can be used to delete still pictures and movies, increasing the amount of space available on the memory card or in internal memory (for information on deleting pictures in single-frame playback, see page 18). *Note that deleted pictures can not be recovered. Copy important pictures to a computer or other storage device before proceeding.*

- 1 Press **MENU/OK** to display the playback menu.

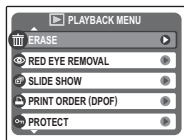

- 2 Press the selector up or down to highlight **ERASE**.



- 3 Press the selector right to display delete options.

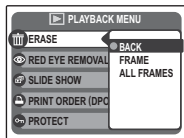

- 4 Press the selector up or down to highlight **FRAME** or **ALL FRAMES**.



- 5 Press **MENU/OK** to display options for the selected item (see pg. 38).



Tips: Deleting Pictures

- When a memory card is inserted, pictures will be deleted from the memory card; otherwise, pictures will be deleted from internal memory.
- Protected pictures can not be deleted. Remove protection from any pictures you wish to delete (pg. 67).
- If a message appears stating that the selected images are part of a DPOF print order, press **MENU/OK** to delete the pictures.

■ FRAME: *Deleting Selected Images*

Selecting **FRAME** displays the dialog shown at right.

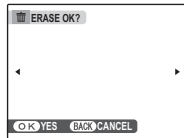

Press the selector left or right to scroll through pictures and press **MENU/OK** to delete the current picture (the picture is deleted immediately; be careful not delete the wrong picture).



Press **DISP/BACK** to exit when all the desired pictures have been deleted.

■ ALL FRAMES: *Deleting All Images*

Selecting **ALL FRAMES** displays the confirmation shown at right.

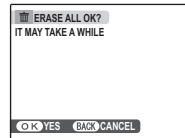

Press **MENU/OK** to delete all unprotected pictures.



The dialog shown at right is displayed during deletion. Press **DISP/BACK** to cancel before all pictures have been deleted (any pictures deleted before the button was pressed can not be recovered).

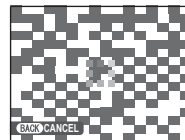

Recording Movies

Shoot short movies at 30 frames per second. Sound is recorded via the built-in microphone; do not cover the microphone during recording.

- 1 Rotate the mode dial to  (movie mode).

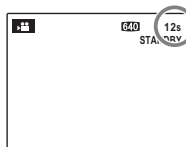

Time available is displayed in monitor

- 2 Frame the scene using the zoom control.

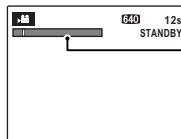

Zoom indicator

Zoom can not be adjusted once recording begins.

Choosing the Frame Size

To choose the frame size, press **MENU/OK** and select **QUALITY**. Choose **640** (640×480 pixels) for better quality, **320** (320×240 pixels) for longer movies. Press **MENU/OK** to return to movie recording mode.

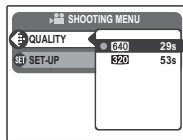

- 3** Press the shutter button all the way down to start recording.



● **REC** and time remaining are displayed in monitor

← Note

Focus is set when recording begins; exposure and white balance are adjusted automatically throughout recording. The color and brightness of the image may vary from that displayed before recording begins.

- 4** Press the shutter button halfway to end recording. Recording ends automatically when the movie reaches maximum length or memory is full.



Tip

There is no need to keep the shutter button pressed during recording.

← Note

Movies are recorded as monaural motion JPEG files with a maximum file size of 2GB and a minimum length of 1 s. See page 94 for more information on recording times.

▶ Viewing Movies

During playback (pg. 34), movies are displayed in the monitor as shown at right. The following operations can be performed while a movie is displayed:

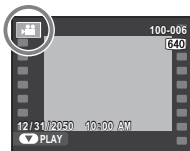

Operation	Description
Start/pause playback	Press the selector down to start playback. Press again to pause.
End playback/delete	Press the selector up to end playback. If playback is paused, pressing the selector up will delete the current movie.
Advance/rewind	Press the selector right to advance, left to rewind. If playback is paused, the movie will advance or rewind one frame each time the selector is pressed.
Adjust volume	Press MENU/OK to pause playback and display volume controls. Press the selector up or down to adjust the volume; press MENU/OK again to resume playback.

Progress is shown in the monitor during playback.

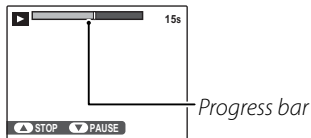

Tip: Viewing Movies on a Computer

Copy movies to the computer before viewing.

⚠ Cautions

- Do not cover the speaker during playback.
- White vertical or dark horizontal streaks may appear in movies containing very bright subjects. This is normal and does not indicate a malfunction.

Viewing Pictures on TV

Connect the camera to a TV and tune the television to the video channel to show pictures to a group. The supplied A/V cable connects as shown below.

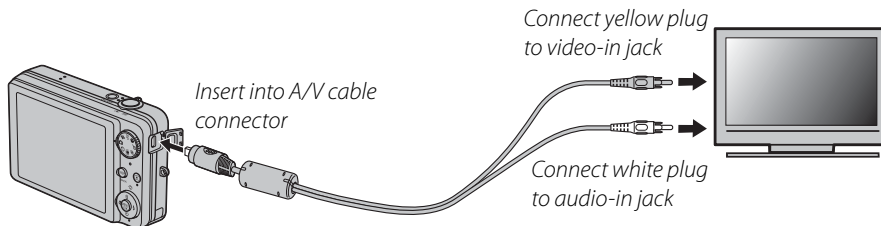

Press **▶** for about a second to turn the camera on. The camera monitor turns off and pictures and movies are played back on the TV. Note that the camera volume controls have no effect on sounds played on the TV; use the television volume controls to adjust the volume.

← Notes

- Use an optional AC-5VX AC adapter and CP-45 DC coupler to power the camera for extended periods (pg. 80).
- Image quality drops during movie playback.

⚠ Caution

When connecting the A/V cable, be sure the connectors are fully inserted.

Printing Pictures via USB

If the printer supports PictBridge, the camera can be connected directly to the printer and pictures can be printed without first being copied to a computer. Note that depending on the printer, not all the functions described below may be supported.



Connecting the Camera

- 1 Connect the supplied USB cable as shown and turn the printer on.

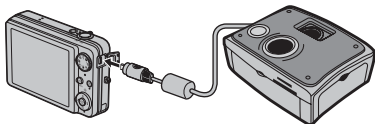

- 2 Press the button for about a second to turn the camera on. **USB** will be displayed in the monitor, followed by the PictBridge display shown below at right.

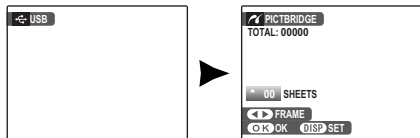

Printing Selected Pictures

- 1 Press the selector left or right to display a picture you wish to print.
- 2 Press the selector up or down to choose the number of copies (up to 99).
- 3 Repeat steps 1–2 to select additional pictures. Press **MENU/OK** to display a confirmation dialog when settings are complete.

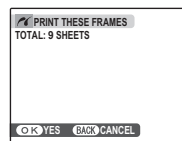

- 4 Press **MENU/OK** to start printing.



Tip: Printing the Date of Recording

To print the date of recording on pictures, press **DISP/BACK** in steps 1–2 to display the PictBridge menu (see “Printing the DPOF Print Order,” below). Press the selector up or down to highlight **PRINT WITH DATE** and press **MENU/OK** to return to the PictBridge display (to print pictures without the date of recording, select **PRINT WITHOUT DATE**). The date will not be printed if the camera clock was not set when the picture was taken.

Note

If no pictures are selected when the **MENU/OK** button is pressed, the camera will print one copy of the current picture.

Printing the DPOF Print Order

To print the print order created with **PRINT ORDER (DPOF)** in the playback menu (pg. 63):

- 1 In the PictBridge display, press **DISP/BACK** to open the PictBridge menu.

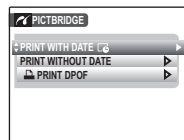

- 2 Press the selector up or down to highlight **PRINT DPOF**.



- 3 Press **MENU/OK** to display a confirmation dialog.

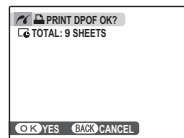

4 Press **MENU/OK** to start printing.



●● **During Printing**

The message shown at right is displayed during printing. Press **DISP/BACK** to cancel before all pictures are printed (depending on the printer, printing may end before the current picture has printed).

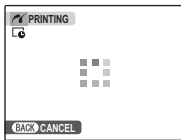

If printing is interrupted, press **▶** to turn the camera off and then on again.

●● **Disconnecting the Camera**

Confirm that "PRINTING" is not displayed in the monitor and press **▶** to turn the camera off. Disconnect the USB cable.

← **Notes**

- Use an optional AC-5VX AC adapter and CP-45 DC coupler to power the camera for extended periods.
- Print pictures from internal memory or a memory card that has been formatted in the camera.
- If the printer does not support date printing, the **PRINT WITH DATE**  option will not be available in the PictBridge menu and the date will not be printed on the pictures in the DPOF print order.
- Default printer page size and print quality settings are used when printing via direct USB connection.

Creating a DPOF Print Order



The  **PRINT ORDER (DPOF)** option in the playback menu can be used to create a digital “print order” for PictBridge-compatible printers (pg. 43) or devices that support DPOF.

DPOF

DPOF (Digital Print Order Format) is standard that allows pictures to be printed from “print orders” stored in internal memory or on a memory card. The information in the order includes the pictures to be printed and the number of copies of each picture.



■ **WITH DATE** / **WITHOUT DATE**

To modify the DPOF print order, select  **PRINT ORDER (DPOF)** in the playback menu and press the selector up or down to highlight **WITH DATE**  or **WITHOUT DATE**.

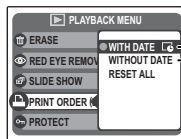

WITH DATE : *Print date of recording on pictures.*

WITHOUT DATE: *Print pictures without date.*

Press **MENU/OK** and follow the steps below.

- 1 Press the selector left or right to display a picture you wish to include in or remove from the print order.



- 2 Press the selector up or down to choose the number of copies (up to 99). To remove a picture from the order, press the selector down until the number of copies is 0.

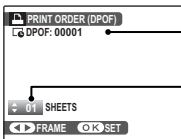

Total number of prints

Number of copies

- 3 Repeat steps 1–2 to complete the print order. Press **MENU/OK** to save the print order when settings are complete, or **DISP/BACK** to exit without changing the print order.



- 4 The total number of prints is displayed in the monitor. Press **MENU/OK** to exit.



The pictures in the current print order are indicated by a  icon during playback.

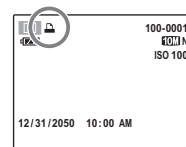

■ RESET ALL

To cancel the current print order, select **RESET ALL** in the  **PRINT ORDER (DPOF)** menu. The confirmation shown at right will be displayed; press **MENU/OK** to remove all pictures from the order.

← Notes

- Remove the memory card to create or modify a print order for the pictures in internal memory.
- Print orders can contain a maximum of 999 pictures.
- If a memory card is inserted containing a print order created by another camera, the message shown at right will be displayed. Pressing **MENU/OK** cancels the print order; a new print order must be created as described above.

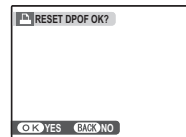
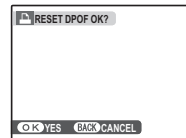

Viewing Pictures on a Computer

The supplied FinePixViewer software can be used to copy pictures to a computer, where they can be stored, viewed, organized, and printed. Before proceeding, install FinePixViewer as described below.

Do NOT connect the camera to the computer until installation is complete.

Installing FinePixViewer

FinePixViewer is available in a Windows version (FinePixViewer S) and a Macintosh version (FinePixViewer). Installation instructions for Windows are on pages 49–51, those for the Macintosh on pages 52–53.

Installing FinePixViewer S: Windows

1 Confirm that the computer meets the following system requirements:

OS	Preinstalled versions of Windows Vista, Windows XP Home Edition (Service Pack 2 or later), Windows XP Professional (Service Pack 2 or later), or Windows 2000 Professional (Service Pack 4 or later)
CPU	<ul style="list-style-type: none">• Windows Vista: 800 MHz Pentium 4 or better (3 GHz Pentium 4 or better recommended)• Windows XP: 800 MHz Pentium 4 or better (2 GHz Pentium 4 or better recommended)• Windows 2000: 200 MHz Pentium or better
RAM	<ul style="list-style-type: none">• Windows Vista: 512 MB or more (1 GB or more recommended)• Windows XP: 512 MB or more• Windows 2000: 128 MB or more
Free disk space	A minimum of 450 MB required for installation with 600 MB available when FinePixViewer is running (15 GB or more recommended under Windows Vista, 2 GB or more recommended under Windows XP)
Video	800 × 600 pixels or more with 16-bit color or better (1,024 × 768 pixels or more with 32-bit color recommended)
Other	<ul style="list-style-type: none">• Built-in USB port recommended. Operation is not guaranteed other USB ports.• Internet connection (56 kbps or faster recommended) required to use FinePix Internet Service; Internet connection and e-mail software required to use e-mail option

Caution

Other versions of Windows are not supported. Operation is not guaranteed on home-built computers or computers that have been upgraded from earlier versions of Windows.

- 2 Start the computer. Log in to an account with administrator privileges before proceeding.
- 3 Exit any applications that may be running and insert the installer CD in a CD-ROM drive.

Windows Vista

If an AutoPlay dialog is displayed, click **SETUP.exe**. A “User Account Control” dialog will then be displayed; click **Allow**.

The installer will start automatically; click **Installing FinePixViewer** and follow the on-screen instructions to install FinePixViewer S. Note that the Windows CD may be required during installation.

If the Installer Does Not Start Automatically

If the installer does not start automatically, select **Computer** or **My Computer** from the Start menu (Windows Vista/XP) or double-click the **My Computer** icon on the desktop (Windows 2000), then double-click the **FINEPIX** CD icon to open the FINEPIX CD window and double-click **SETUP** or **SETUP.exe**.

- 4** If prompted to install Windows Media Player or DirectX, follow the on-screen instructions to complete installation.
- 5** When prompted, remove the installer CD from the CD-ROM drive and click **Restart** to restart the computer. Store the installer CD in a dry location out of direct sunlight in case you need to re-install the software. The version number is printed at the top of the CD label for reference when updating the software or contacting customer support.

Installation is now complete. Proceed to “Connecting the Camera” on page 54.

Installing FinePixViewer: Macintosh

1 Confirm that the computer meets the following system requirements:

Model	Power Macintosh G3, PowerBook G3, Power Mac G4, iMac, iBook, Power Mac G4 Cube, PowerBook G4, Power Mac G5, MacBook, MacBook Pro, Mac mini, or Mac Pro
CPU	PowerPC or Intel
OS	Mac OS X version 10.3.9–10.4.11 (as of August 1, 2008; visit http://www.fujifilm.com for more information)
RAM	256 MB or more
Free disk space	A minimum of 200 MB required for installation with 400 MB available when FinePixViewer is running
Video	800×600 pixels or more with thousands of colors or better
Other	<ul style="list-style-type: none"> • Built-in USB port recommended. Operation is not guaranteed other USB ports. • Internet connection (56 kbps or faster recommended) required to use FinePix Internet Service; Internet connection and e-mail software required to use e-mail option

2 After starting the computer and quitting any applications that may be running, insert the installer CD in a CD-ROM drive. Double-click the **FinePix CD** icon on the desktop and double-click **Installer for Mac OS X**.

3 An installer dialog will be displayed; click **Installing FinePixViewer** to start installation. Enter an administrator name and password when prompted and click **OK**, then follow the on-screen instructions to install FinePixViewer. Click **Exit** to quit the installer when installation is complete.

- 4** Remove the installer CD from the CD-ROM drive. Note that you may be unable to remove the CD if Safari is running; if necessary, quit Safari before removing the CD. Store the installer CD in a dry location out of direct sunlight in case you need to re-install the software. The version number is printed at the top of the CD label for reference when updating the software or contacting customer support.
- 5** Select **Applications** in the Finder **Go** menu to open the applications folder. Double-click the **Image Capture** icon and select **Preferences...** from the Image Capture application menu.

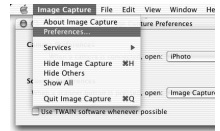

The Image Capture preferences dialog will be displayed. Choose **Other...** in the **When a camera is connected, open** menu, then select **FPVBridge** in the "Applications/FinePixViewer" folder and click **Open**.



Select **Quit Image Capture** from the Image Capture application menu.

Installation is now complete. Proceed to "Connecting the Camera" on page 54.

Connecting the Camera

1 If the pictures you wish to copy are stored on a memory card, insert the card into the camera (pg. 9). If no card is inserted, pictures will be copied from internal memory.

⚠ Caution

Loss of power during transfer could result in loss of data or damage to internal memory or the memory card. Fully charge the battery before connecting the camera or use an optional AC-5VX AC adapter and CP-45 DC coupler.

2 Turn the camera off and connect the supplied USB cable as shown, making sure the connectors are fully inserted. Connect the camera directly to the computer; do not use a USB hub or keyboard.

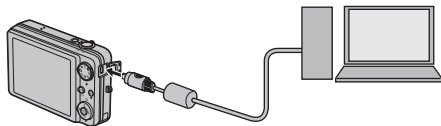

3 Press the **▶** button for about a second to turn the camera on. FinePixViewer will start automatically and the “Save Image Wizard” will be displayed. Follow the on-screen instructions to copy pictures to the computer. To exit without copying pictures, click **CANCEL**.

⚠ Caution

If FinePixViewer does not start automatically, the software may not be correctly installed. Disconnect the camera and reinstall the software.

For more information on using FinePixViewer, select **How to Use FinePixViewer** in the FinePixViewer **Help** menu.

← Note

The camera will not turn off automatically while connected to a computer.

Cautions

- Use only memory cards that have been formatted in the camera and contain pictures taken with the camera. If a memory card containing a large number of images is inserted, there may be a delay before FinePixViewer starts and FinePixViewer may be unable to import or save images. Use a memory card reader to transfer pictures.
- Make sure the indicator lamp is out before turning the camera off or disconnecting the USB cable. Failure to observe this precaution could result in loss of data or damage to internal memory or the memory card.
- Disconnect the camera before inserting or removing memory cards.
- In some cases, it may not be possible to access pictures saved to a network server using FinePixViewer in the same way as on a standalone computer.
- The user bears all applicable fees charged by the phone company or Internet service provider when using services that require an Internet connection.

Disconnecting the Camera

After confirming that the indicator lamp is out, follow the on-screen instructions to turn the camera off and disconnect the USB cable.

Uninstalling FinePixViewer

Only uninstall FinePixViewer before reinstalling the software or when it is no longer required. After quitting FinePixViewer and disconnecting the camera, drag the “FinePixViewer” folder from “Applications” into the Trash and select **Empty Trash** in the **Finder** menu (Macintosh), or open the control panel and use “Programs and Features” (Windows Vista) or “Add/Remove Programs” (other versions of Windows) to uninstall FinePixViewer. Under Windows, one or more confirmation dialogs may be displayed; read the contents carefully before clicking **OK**.

The Shooting Menu

The shooting menu is used to adjust settings for a wide range of shooting conditions.

Using the Shooting Menu

- 1 Press **MENU/OK** to display the shooting menu.

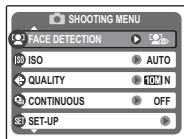

← Note

The options displayed in the shooting menu vary depending on the shooting mode.

- 2 Press the selector up or down to highlight the desired menu item.



- 3 Press the selector right to display options for the highlighted item.

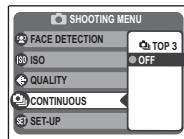



















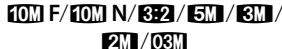

- 4 Press the selector up or down to highlight the desired option.



- 5 Press **MENU/OK** to select the highlighted option.

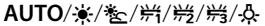

Shooting Menu Options

Menu item	Description	Options	Default
 SCENE POSITION	Choose a scene for SP mode (pg. 30).		
 FACE DETECTION	Turn Intelligent Face Detection and red-eye removal on or off (pg. 19).		
 ISO	Adjust ISO sensitivity (pg. 58). Choose higher values when the subject is poorly lit.	AUTO/3200  / 1600/800/400/200/100/64	AUTO
 QUALITY	Choose image size and quality (pg. 59).		
 EXP. COMPENSATION	Adjust exposure for bright, dark, or high-contrast scenes (pg. 60).	-2 EV to +2 EV in increments of 1/3 EV	±0
 PHOTOMETRY	Choose how exposure is metered in  mode (pg. 61).		
 WHITE BALANCE	Adjust color for different light sources (pg. 61).	AUTO/ 	AUTO
 CONTINUOUS	Shoot a series of pictures (pg. 62).	 /OFF	OFF
 SET-UP	Perform basic camera setup such as choosing a language and setting the time and date (pg. 72).		—

ISO ISO

Control the camera's sensitivity to light. Higher values can be used to reduce blur when lighting is poor; note, however, that mottling may appear in pictures taken at high sensitivities. If **AUTO** is selected, the camera will adjust sensitivity automatically in response to shooting conditions.

In shooting modes other than **CM**, sensitivity is set to **AUTO**; other values can not be selected. Settings other than **AUTO** are shown by an icon in the monitor. At a setting of **3200** **3M**, image sizes over **3M** are set to **3M** (pg. 59). Settings that have been altered from the value selected by the user are shown in yellow.

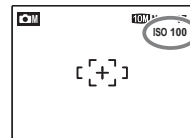

QUALITY

Choose the size and quality at which still pictures are recorded. Large pictures can be printed at large sizes with no drop in quality; small pictures require less memory, allowing more pictures to be recorded.

Option	Prints at sizes up to
10M F	31 × 23 cm/12 × 9 in. (10M) or 31 × 21 cm/12 × 8 in. (3:2). Choose 10M F for high-quality prints, 3:2 for an aspect ratio of 3:2.
3:2	
5M	22 × 16 cm (8.5 × 6.5 in.)
3M	17 × 13 cm (7 × 5 in.)
2M	14 × 10 cm (5.3 × 4 in.)
03M	5 × 4 cm (2 × 1.5 in.). Suited to e-mail or the web.

The number of pictures that can be taken at current settings (pg. 94) is displayed to the right of the image quality icon in the monitor.

Aspect Ratio

Pictures taken at an image quality setting of **3:2** have an aspect ratio of 3:2, the same as a frame of 35-mm film. Pictures taken at other settings have an aspect ratio of 4:3.



4:3



3:2

Notes

- At settings of **5M** or higher, sensitivities over 1600 are set to 1600. Settings that have been altered from the value selected by the user are shown in yellow.
- Image quality is not reset when the camera is turned off or another shooting mode is selected.

EXP. COMPENSATION

Use exposure compensation when photographing very bright, very dark, or high-contrast subjects.

Choose positive (+) values to increase exposure



Choose negative (-) values to reduce exposure

Choosing an Exposure Compensation Value

- **Backlit subjects:** choose values from $+\frac{2}{3}$ EV to $+1\frac{2}{3}$ EV (for an explanation of the term "EV", see the Glossary on page 92)







- **Highly reflective subjects or very bright scenes** (e.g., snowfields): +1 EV



- **Scenes that are mostly sky:** +1 EV
- **Spotlit subjects** (particularly if photographed against dark backgrounds): $-\frac{2}{3}$ EV
- **Subjects with low reflectivity** (pine trees or dark-colored foliage): $-\frac{2}{3}$ EV

Notes

- Exposure compensation is available in **AM** mode only.
- At settings other than ± 0 , a  icon is displayed in the monitor. Exposure compensation is not reset when the camera is turned off; to restore normal exposure control, choose a value of ± 0 . Exposure compensation is disabled if the flash fires when set to AUTO or  (auto with red-eye reduction); when the flash is set to  or , exposure compensation is disabled if the subject is dark.

PHOTOMETRY

Choose how the camera meters exposure (📷 mode only; not available when Intelligent Face Detection is on).

- **[📷] MULTI:** Automatic scene recognition is used to adjust exposure for a wide range of shooting conditions.
- **[📷] SPOT:** The camera meters lighting conditions at the center of the frame. Recommended when the background is much brighter or darker than the main subject. Can be used with focus lock (pg. 22) to meter off-center subjects.
- **[📷] AVERAGE:** Exposure is set to the average for the entire frame. Provides consistent exposure across multiple shots with the same lighting.

WB WHITE BALANCE

For natural colors, choose a setting that matches the light source (for an explanation of “white balance,” see the Glossary on page 92).

Option	Description
AUTO	White balance adjusted automatically.
☀️	For subjects in direct sunlight.
🌿	For subjects in the shade.
🔍	Use under “daylight” fluorescent lights.
🔍	Use under “warm white” fluorescent lights.
🔍	Use under “cool white” fluorescent lights.
💡	Use under incandescent lighting.

If **AUTO** does not produce the desired results (for example, when taking close-ups), choose the option that matches the light source.

← Notes

- This option is available in 📷 mode only.
- Auto white balance is used with the flash. Turn the flash off (pg. 25) to take pictures at other settings.
- Results vary with shooting conditions. Play pictures back after shooting to check colors in the monitor.

CONTINUOUS

Select  **TOP 3** to capture motion in a series of pictures. The camera takes up to three pictures while the shutter-release button is pressed.

Notes

- The flash turns off automatically (pg. 25), and focus and exposure are determined by the first frame in each series. The previously-selected flash mode is restored when **OFF** is selected for  **CONTINUOUS**.
- Frame rate varies with shutter speed.
- The number of pictures that can be recorded depends on the memory available. Additional time may be required to record pictures when shooting ends. The pictures are displayed in the monitor while recording is in progress.



The Playback Menu

The playback menu is used to manage the pictures in internal memory or on the memory card.

Using the Playback Menu

1 Press  to enter playback mode (pg. 34).



2 Press **MENU/OK** to display the playback menu.

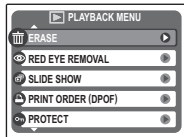

3 Press the selector up or down to highlight the desired menu item.



4 Press the selector right to display options for the highlighted item.

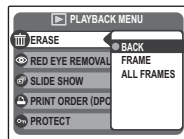

5 Press the selector up or down to highlight the desired option.











6 Press **MENU/OK** to select the highlighted option.



Playback Menu Options

The following options are available:

Option	Description
 ERASE	Delete all or selected pictures (pg. 37).
 RED-EYE REMOVAL	Create copies with reduced red eye (pg. 65).
 SLIDE SHOW	View pictures in a slide show (pg. 66).
 PRINT ORDER (DPOF)	Select pictures for printing on DPOF- and PictBridge-compatible devices (pg. 46).
 PROTECT	Protect pictures from accidental deletion (pg. 67).
 COPY	Copy pictures between internal memory and a memory card (pg. 68).
 IMAGE ROTATE	Rotate pictures (pg. 70).
 TRIMMING	Create cropped copies of pictures (pg. 71).
 SET-UP	Perform basic camera setup (pg. 72).

👁️ RED EYE REMOVAL

This option is used with pictures taken using Intelligent Face Detection to create copies that have been processed to remove red eye.

- 1 Play the picture back in the monitor (pictures taken with Intelligent Face Detection are indicated by a 👤 icon) and select **👁️ RED EYE REMOVAL** in the playback menu (pg. 63).



- 2 Press **MENU/OK**. The message shown below at left will be displayed while the camera analyses the image; if red-eye is detected, the message shown below at right will be displayed while the camera processes the image to create a copy with reduced red-eye.

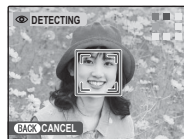

← Notes

- Red eye may not be removed if the camera is unable to detect a face or the face is in profile. Results may differ depending on the scene. Red eye can not be removed from pictures that have already been processed using red-eye removal or pictures created with other devices.
- The amount of time needed to process the image varies with the number of faces detected.
- Copies created with **👁️ RED EYE REMOVAL** are indicated by a 👁️ icon during playback.

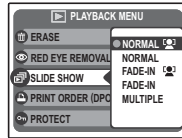

SLIDE SHOW

View pictures in an automated slide show. Choose the type of show and press **MENU/OK** to start. Press **DISP/BACK** at any time during the show to view on-screen help. When a movie is displayed, movie playback will begin automatically, and the slide show will continue when the movie ends. The show can be ended at any time by pressing **MENU/OK**.



Note

The camera will not turn off automatically while a slide show is in progress.

Option	Description
NORMAL	Press selector left or right to go back or skip ahead one frame. Select FADE-IN for fade transitions between frames.
FADE-IN	
NORMAL 	As above, except that camera automatically zooms in on faces selected with Intelligent Face detection (pg. 19).
FADE-IN 	
MULTIPLE	

PROTECT

Protect pictures from accidental deletion. The following options are available.

■ FRAME

Protect selected pictures.

- 1 Press the selector left or right to display the desired picture.

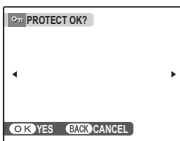

Picture not protected

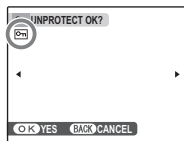

Protected picture

- 2 Press **MENU/OK** to protect the picture. If the picture is already protected, pressing **MENU/OK** will remove protection from the image.



- 3 Repeat steps 1–2 to protect additional images. Press **DISP/BACK** to exit when the operation is complete.



■ SET ALL

Press **MENU/OK** to protect all pictures, or press **DISP/BACK** to exit without changing picture status.

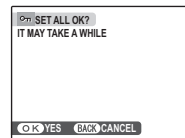

■ RESET ALL

Press **MENU/OK** to remove protection from all pictures, or press **DISP/BACK** to exit without changing picture status.

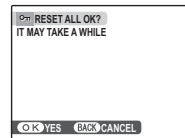

If the number of pictures affected is very large, the display at right will appear in the monitor while the operation is in progress. Press **DISP/BACK** to exit before the operation is complete.

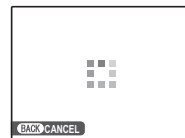

Caution

Protected pictures will be deleted when the memory card or internal memory is formatted (pg. 77).

COPY

Copy pictures between internal memory and a memory card.

- 1 Press the selector up or down to highlight **INTERNAL MEMORY** → **SD CARD** (copy pictures from internal memory to the memory card) or **SD CARD** → **INTERNAL MEMORY** (copy pictures from a memory card to internal memory).



- 2 Press the selector right to display options for the highlighted item.

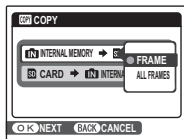

- 3 Press the selector up or down to highlight **FRAME** or **ALL FRAMES**.



- 4 Press **MENU/OK**.



Tip: Copying Pictures Between Memory Cards

To copy pictures between two memory cards, insert the source card and copy the pictures to internal memory, then remove the source card, insert the destination card, and copy the pictures from internal memory.

■ FRAME

Copy selected frames.

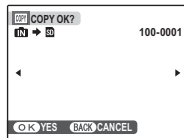

1 Press the selector left or right to display the desired picture.



2 Press **MENU/OK** to copy the picture.



3 Repeat steps 1–2 to copy additional images. Press **DISP/BACK** to exit when the operation is complete.



■ ALL FRAMES

Press **MENU/OK** to copy all pictures, or press **DISP/BACK** to exit without copying pictures.

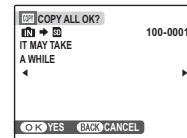

⚠ Cautions

- Copying ends when the destination is full.
- DPOF print information is not copied (pg. 46).

🔄 IMAGE ROTATE

By default, pictures taken in tall orientation are displayed in wide orientation. Use this option to display pictures in the correct orientation in the monitor. It has no effect on pictures displayed on a computer or other device.

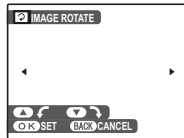

👉 Notes

- Protected pictures can not be rotated. Remove protection before rotating pictures (pg. 67).
- The camera may not be able to rotate pictures created with other devices.

To rotate a picture, play the picture back and select 🔄 **IMAGE ROTATE** in the playback menu (pg. 63).

- 1 Press the selector down to rotate the picture 90° clockwise, up to rotate the picture 90° counterclockwise.

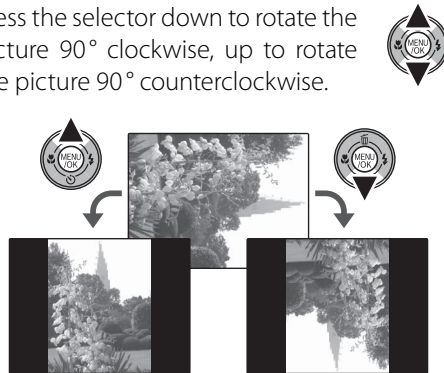

- 2 Press **MENU/OK** to confirm the operation (to exit without rotating the picture, press **DISP/BACK**).

The next time the picture is played back, it will automatically be rotated.

TRIMMING

To create a cropped copy of a picture, play the picture back and select **TRIMMING** in the playback menu (pg. 63).

- Use the zoom control to zoom in and out and use the selector to scroll the picture until the desired portion is displayed (to exit to single-frame playback without creating a cropped copy, press **DISP/BACK**).

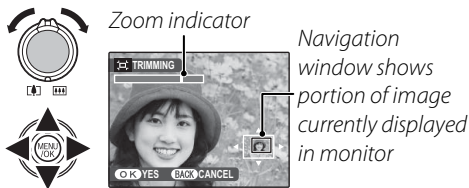

- Press **MENU/OK**. A confirmation dialog will be displayed.

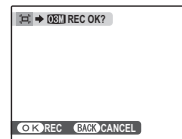

Copy size (**5M**, **3M**, **2M**, or **03M**; see page 59) is shown at the top; if the size is **03M**, **OK** is displayed in yellow. Larger crops produce larger copies; all copies have an aspect ratio of 4:3.

- Press **MENU/OK** to save the cropped copy to a separate file.



The Setup Menu

Using the Setup Menu

1 Display the setup menu.

1.1 Press **MENU/OK** to display the menu for the current mode.



1.2 Press the selector up or down to highlight **SET SET-UP**.



1.3 Press the selector right to display the setup menu.

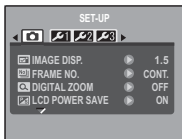

2 Choose a page.

2.1 Press the selector left or right to choose a page.



2.2 Press the selector down to enter the menu.



3 Adjust settings.

3.1 Press the selector up or down to highlight a menu item.



3.2 Press the selector right to display options for the highlighted item.

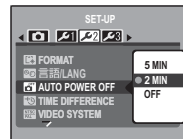















3.3 Press the selector up or down to highlight an option.



3.4 Press **MENU/OK** to select the highlighted option.



Setup Menu Options

	Menu item	Description	Options	Default
📷	 IMAGE DISP.	Choose how long pictures are displayed after shooting (pg. 74).	CONTINUOUS / 3 SEC / 1.5 SEC / ZOOM (CONTINUOUS) / OFF	1.5 SEC
	 FRAME NO.	Choose how files are named (pg. 75).	CONTINUOUS / RENEW	CONTINUOUS
	 DIGITAL ZOOM	Enable or disable digital zoom (pg. 76).	ON / OFF	OFF
	 LCD POWER SAVE	Enable or disable monitor power saving (pg. 76).	ON / OFF	ON
🔊	 DATE/TIME	Set the camera clock (pg. 13).	—	—
	 OPERATION VOL.	Adjust the volume of camera controls.	🔊 (high) / 🔊 (mid) / 🔊 (low) / 🔊 OFF (mute)	🔊
	 SHUTTER VOLUME	Adjust the volume of the shutter sound.		
	 PLAYBACK VOLUME	Adjust the volume for movie playback (pg. 76).	—	—
	 LCD BRIGHTNESS	Control the brightness of the monitor (pg. 76).	-5 - +5	0
🔧	 FORMAT	Format internal memory or memory cards (pg. 77).	—	—
	 言語/LANG	Choose a language (pg. 13).	See page 96	ENGLISH
	 AUTO POWER OFF	Choose the auto power off delay (pg. 77).	5 MIN / 2 MIN / OFF	2 MIN
	 TIME DIFFERENCE	Set the clock to local time (pg. 78).	🏠 / ✈️	🏠
	 VIDEO SYSTEM	Choose a video mode for connection to a TV (pg. 42).	NTSC / PAL	—
🔧	 RESET	Reset all settings except DATE/TIME , TIME DIFFERENCE , and VIDEO SYSTEM to default values. A confirmation dialog will be displayed, press the selector left or right to highlight OK and press MENU/OK .	—	—

☑ IMAGE DISP.

Choose an option other than **OFF** to display pictures in the monitor after shooting. Pictures can be displayed for 1.5 s (**1.5 SEC**), 3 s (**3 SEC**), or until the **MENU/OK** button is pressed (**CONTINUOUS** and **ZOOM (CONTINUOUS)**). If **ZOOM (CONTINUOUS)** is selected, photos taken at qualities larger than **03M** can be zoomed in to check focus and other fine details (see page 35). If Intelligent Face Detection is on (pg. 19), the camera will automatically zoom in on the face used to set focus and exposure; press the selector down to cycle through the other faces detected. Note that **ZOOM (CONTINUOUS)** is disabled during continuous shooting (pg. 62), and that the colors displayed at settings of **1.5 SEC** and **3 SEC** may differ from those in the final picture.

▶ **FRAME NO.**

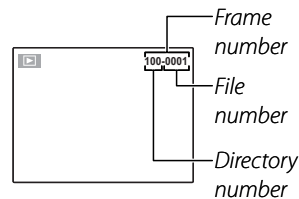

New pictures are stored in image files named using a four-digit file number assigned by adding one to the last file number used. The file number is displayed during playback as shown at right. **FRAME NO.** controls whether file numbering is reset to 0001 when a new memory card is inserted or the current memory card or internal memory is formatted.

- **CONTINUOUS:** Numbering continues from the last file number used or the first available file number, whichever is higher. Choose this option to reduce the number of pictures with duplicate file names.
- **RENEW:** Numbering is reset to 0001 after formatting or when a new memory card is inserted.

**← Notes**

- If the frame number reaches 999-9999, the shutter release will be disabled (pg. 90).
- Selecting **+** **RESET** (pg. 73) does not reset frame numbering.
- Frame numbers for pictures taken with other cameras may differ.

DIGITAL ZOOM

If **ON** is selected, selecting  at the maximum optical zoom position will trigger digital zoom, further magnifying the image. To cancel digital zoom, zoom out to the minimum digital zoom position and select .

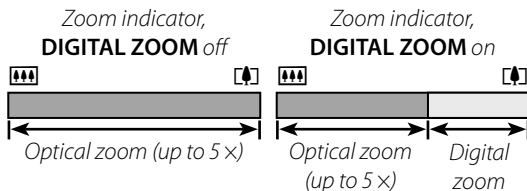
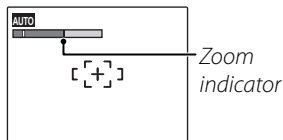

Caution

Digital zoom produces lower quality images than optical zoom.

LCD POWER SAVE

If **ON** is selected, the monitor will dim to save power if no operations are performed for about ten seconds. Full brightness can be restored by pressing the shutter button halfway. The monitor does not dim in movie mode or during playback.

PLAYBACK VOLUME

Press the selector up or down to choose volume for movie playback and press **MENU/OK** to select.

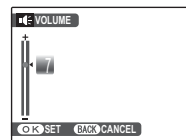

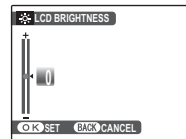

LCD BRIGHTNESS

Press the selector up or down to choose monitor brightness and press **MENU/OK** to select.



FORMAT

Format internal memory or a memory card. If a memory card is inserted in the camera,  will be displayed in the dialog shown at right and this option will format the memory card. If no memory card is inserted,  will be displayed and this option will format internal memory. Press the selector left to highlight **OK** and press **MENU/OK** to begin formatting.

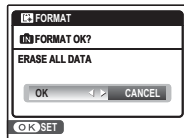

Cautions

- All data—including protected pictures—will be deleted. Be sure important files have been copied to a computer or other storage device.
- Do not open the battery cover during formatting.

AUTO POWER OFF

Choose the length of time before the camera turns off automatically when no operations are performed. Shorter times increase battery life; if **OFF** is selected, the camera must be turned off manually. Note that regardless of the option selected, the camera will not turn off automatically when connected to a printer (pg. 43) or computer (pg. 54) or when a slide show is in progress (pg. 66).

Tip: Reactivating the Camera

To reactivate the camera after it has turned off automatically, press the **ON/OFF** button or press the  button for about a second (pg. 12).

TIME DIFFERENCE

When travelling, use this option to switch the camera clock instantly from your home time zone to the local time at your destination.

1 Specify the difference between local time and your home time zone.

1.1 Press the selector up or down to highlight **← LOCAL**.



1.2 Press the selector right to display the time difference.

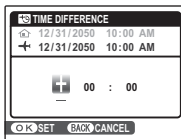

1.3 Press the selector left or right to highlight +, -, hours, or minutes; press up or down to edit. The minimum increment is 15 minutes.



1.4 Press **MENU/OK** when settings are complete.



2 Switch between local time and your home time zone.

To set the camera clock to local time, highlight **← LOCAL** and press **MENU/OK**. To set the clock to the time in your home time zone, select **HOME**. If **← LOCAL** is selected, **←** will be displayed in the monitor for three seconds after the camera enters shooting mode, and the date will be displayed in yellow.

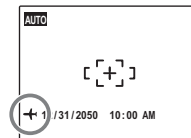

After changing time zones, check that the date and time are correct.

Optional Accessories

The camera supports a wide range of accessories from FUJIFILM and other manufacturers. The following accessories were available as of August 2008.

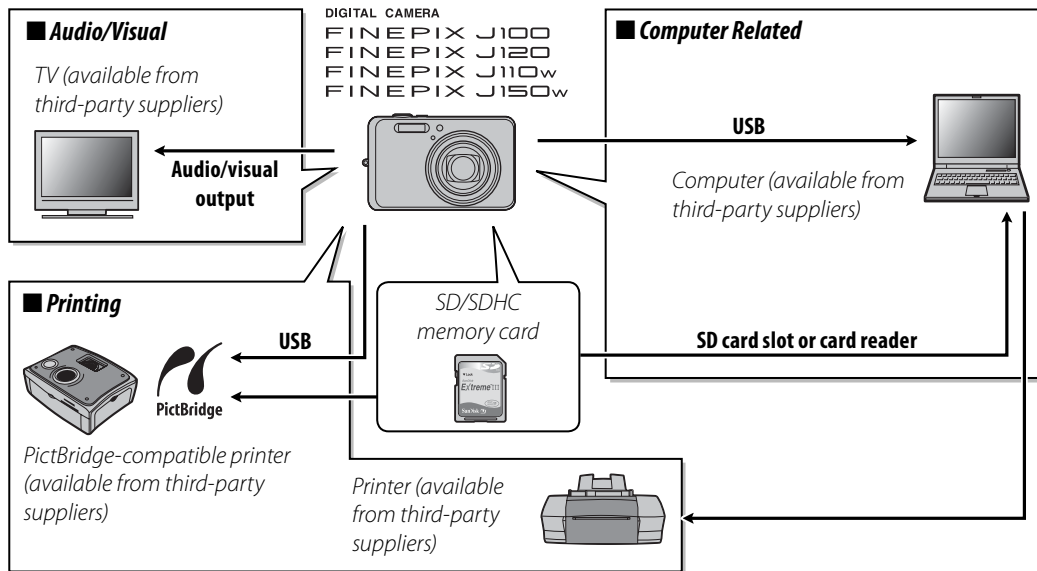

Accessories from Fujifilm

As of August 2008, the following optional accessories were available from FUJIFILM. For the latest information on the accessories available in your region, check with your local Fujifilm representative or visit http://www.fujifilm.com/products/digital_cameras/index.html.

- **NP-45 rechargeable Li-ion battery** (supplied): Additional NP-45 slimline batteries can be purchased as required.
- **BC-45 battery charger**: Replacement battery chargers can be purchased as required. The BC-45 charges an NP-45 battery in about 180 minutes at +23 °C (+73 °F).
- **AC-5VX AC adapter** (requires CP-45 DC coupler): Use for extended playback or when copying pictures to a computer (shape of adapter and plug vary with region of sale).
- **CP-45 DC coupler**: Connect the AC-5VX AC adapter to the camera.

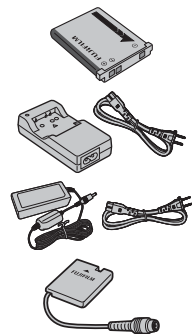

Caring for the Camera

To ensure continued enjoyment of the product, observe the following precautions.

Storage and Use

If the camera will not be used for an extended period, remove the battery and memory card. Do not store or use the camera in locations that are:

- exposed to rain, steam, or smoke
- very humid or extremely dusty
- exposed to direct sunlight or very high temperatures, such as in a closed vehicle on a sunny day
- extremely cold
- subject to strong vibration
- exposed to strong magnetic fields, such as near a broadcasting antenna, power line, radar emitter, motor, transformer, or magnet
- in contact with volatile chemicals such as pesticides
- next to rubber or vinyl products

Water and Sand

Exposure to water and sand can also damage the camera and its internal circuitry and mechanisms. When using the camera at the beach or seaside, avoid exposing the camera to water or sand. Do not place the camera on a wet surface.

Condensation

Sudden increases in temperature, such as occur when entering a heated building on a cold day, can cause condensation inside the camera. If this occurs, turn the camera off and wait an hour before turning it on again. If condensation forms on the memory card, remove the card and wait for the condensation to dissipate.

Cleaning

Use a blower to remove dust from the lens and monitor, then gently wipe with a soft, dry cloth. Any remaining stains can be removed by wiping gently with a piece of FUJIFILM lens-cleaning paper to which a small amount of lens-cleaning fluid has been applied. Care should be taken to avoid scratching the lens or monitor. The camera body can be cleaned with a soft, dry cloth. Do not use alcohol, thinner, or other volatile chemicals.

Travelling

Keep the camera in your carry-on baggage. Checked baggage may suffer violent shocks that could damage the camera.

Troubleshooting

Power and Battery

Problem		Possible cause	Solution	Page
Power supply	The camera does not turn on.	The battery is exhausted.	Charge the battery or insert a fully-charged spare battery.	5, 7
		The battery is not in the correct orientation.	Re-insert the battery in the correct orientation.	7
		The battery-chamber cover is not latched.	Latch the battery-chamber cover.	8
		The AC adapter and DC coupler are not connected properly.	Make sure that the AC adapter and DC coupler are properly connected.	—
	The battery runs down quickly.	The battery is cold.	Warm the battery by placing it in a pocket or other warm place and re-insert it in the camera immediately before taking a picture.	7
		There is dirt on the battery terminals.	Clean the terminals with a soft, dry cloth.	—
		The battery has been charged many times.	The battery has reached the end of its charging life. Purchase a new battery.	—
	The camera turns off suddenly.	The battery is exhausted.	Charge the battery or insert a fully-charged spare battery.	5, 7
		The AC adapter or DC coupler has been disconnected.	Make sure that the AC adapter and DC coupler are properly connected.	—
	Battery charger	Charging does not start.	The battery is not correctly inserted.	Re-insert the battery in the charger.
The battery is not in the correct orientation.			Re-insert the battery in the correct orientation.	5
Charging is slow.		The temperature is low.	Charge the battery at room temperature.	v
The charging lamp lights, but the battery does not charge.		There is dirt on the battery terminals.	Clean the terminals with a soft, dry cloth.	—
		The battery has been charged many times.	The battery has reached the end of its charging life. Purchase a new battery. If the battery still fails to charge, contact your FUJIFILM dealer.	—

Menus and Displays

Problem	Possible cause	Solution	Page
Menus and displays are not in English.	English is not selected for the  言語/LANG option in the setup menu.	Select ENGLISH .	13

Shooting

Problem	Possible cause	Solution	Page
Taking pictures	Memory is full.	Insert a new memory card or delete pictures.	9, 37
	Memory is not formatted.	Format the memory card or internal memory.	77
	There is dirt on the memory card contacts.	Clean the contacts with a soft, dry cloth.	10
	The memory card is damaged.	Insert a new memory card.	9
	The battery is exhausted.	Charge the battery or insert a fully-charged spare battery.	5, 7
	The camera has turned off automatically.	Turn the camera on.	12, 77
The monitor goes dark after shooting.	The flash has fired.	The monitor may darken while the flash charges. Wait for the flash to charge.	25
Focus	The subject is close to the camera.	Select macro mode.	24
	The subject is far away from the camera.	Cancel macro mode.	
	The camera does not focus.	The subject is not suited to autofocus.	Use focus lock.



	Problem	Possible cause	Solution	Page
Intelligent Face Detection	Face detection not available.	The camera is in or mode.	Choose a different shooting mode.	29
	No face is detected.	The subject's face is obscured sunglasses, a hat, long hair, or other objects.	Remove the obstructions.	19
		The subject's face occupies only a small area of the frame.	Change the composition so that the subject's face occupies a larger area of the frame.	
		The subject's head is tilted or horizontal.	Ask the subject to hold their head straight.	15
		The camera is tilted.	Hold the camera straight.	
		The subject's face is poorly lit.	Shoot in bright light.	—
Wrong subject selected.	The selected subject is closer to the center of the frame than the main subject.	Recompose the picture or turn face detection off and frame the picture using focus lock.	22	
Close-ups	Macro mode is not available.	The camera is in or mode.	Choose a different shooting mode.	29
Flash	The flash does not fire.	The flash is charging.	Wait for the flash to charge.	17
		or mode is selected.	Choose a different shooting mode.	29
		The battery is exhausted.	Charge the battery or insert a fully-charged spare battery.	5, 7
		The camera is in continuous mode.	Select OFF for CONTINUOUS .	62
		The flash is off ().	Choose a different flash mode.	25
	Some flash modes are not available.	The camera is in or mode.	Choose a different shooting mode.	29
The flash does not fully light the subject.	The subject is not in range of the flash.	Position the subject in range of the flash.	96	
	The flash window is obstructed.	Hold the camera correctly.	15	

	Problem	Possible cause	Solution	Page
Problem images	Pictures are blurred.	The lens is dirty.	Clean the lens.	81
		The lens is blocked.	Keep objects away from the lens.	15
		!AF is displayed during shooting and the focus frame is displayed in red.	Check focus before shooting.	16, 22, 88
		!CF is displayed during shooting.	Use the flash or a tripod.	25
	Pictures are mottled.	The ambient temperature is high and the subject is poorly lit.	This is normal and does not indicate a malfunction. Choose a lower sensitivity.	58
Recording	Pictures are not recorded.	Power was interrupted during shooting.	Turn the camera off before connecting the AC adapter/DC coupler. Leaving the camera on can result in corrupted files or damage to the memory card or internal memory.	—

Playback

	Problem	Possible cause	Solution	Page
Pictures	Pictures are grainy.	The pictures were taken with a different make or model of camera.	—	—
	Playback zoom unavailable.	The pictures were taken at an image size of OSM or with a different make or model of camera.	—	—
Audio	No sound in movie playback.	Playback volume is too low.	Adjust playback volume.	41, 76
		The microphone was obstructed.	Hold the camera correctly during recording.	39
		The speaker is obstructed.	Hold the camera correctly during playback.	41
Deletion	Selected pictures are not deleted.	Some of the pictures selected for deletion are protected.	Remove protection using the device with which it was originally applied.	67
Frame no.	File numbering is unexpectedly reset.	The battery-chamber cover was opened while the camera was on.	Turn the camera off before opening the battery-chamber cover to replace the battery or insert a memory card.	12, 75

Connections



	Problem	Possible cause	Solution	Page
TV	No picture or sound.	The camera is not properly connected.	Connect the camera correctly.	42
		The supplied A/V cable was connected during movie playback.	Connect the camera once movie playback has ended.	41, 42
		Input on the television is set to "TV".	Set input to "VIDEO".	—
		The camera is not set to the correct video standard.	Match the camera  VIDEO SYSTEM setting to the TV.	42, 73
	The volume on the television is too low.	Adjust the volume.	—	
	No color.	The camera is not set to the correct video standard.	Match the camera  VIDEO SYSTEM setting to the TV.	42, 73
Computer	The computer does not recognize the camera.	The camera is not properly connected.	Connect the camera correctly.	54
PictBridge	Pictures can not be printed.	The camera is not properly connected.	Connect the camera correctly.	43
		The printer is off.	Turn the printer on.	—
	Only one copy is printed. The date is not printed.	The printer is not PictBridge-compatible.	—	—



Miscellaneous

Problem	Possible cause	Solution	Page
Nothing happens when the shutter button is pressed.	Temporary camera malfunction.	Remove and reinsert the battery or disconnect and reconnect the AC adapter/DC coupler.	7
	The battery is exhausted.	Charge the battery or insert a fully-charged spare battery.	5, 7
The camera does not function as expected.	Temporary camera malfunction.	Remove and reinsert the battery or disconnect and reconnect the AC adapter/DC coupler. If the problem persists, contact your FUJIFILM dealer.	7, 100

Warning Messages and Displays

The following warnings are displayed in the monitor:

Warning	Description	Solution
 (red)	Low battery.	Charge the battery or insert a fully-charged spare battery.
 (blinks red)	Battery exhausted.	
	Slow shutter speed. Picture may be blurred.	Use the flash or mount the camera on a tripod.
!AF (displayed in red with red focus frame)	The camera can not focus.	<ul style="list-style-type: none"> • Use focus lock to focus on another subject at the same distance, then recompose the picture (pg. 22). • If the subject is poorly lit, try focusing at a distance of about 2 m (6 ft. 7 in.). • Use macro mode to focus when taking close-ups.
!AE (blinks red)	The subject is too bright or too dark. The picture will be over- or under-exposed.	If the subject is dark, use the flash.
FOCUS ERROR	Camera malfunction.	Turn the camera off and then on again, taking care not to touch the lens. If the message persists, contact a FUJIFILM dealer (pg. 100).
ZOOM ERROR		
NO CARD	No memory card inserted when COPY is selected in the playback menu.	Insert a memory card.
CARD NOT INITIALIZED	The memory card or internal memory is not formatted.	Format the memory card or internal memory (pg. 77).
	The memory card contacts require cleaning.	Clean the contacts with a soft, dry cloth. If the message is repeated, format the memory card (pg. 77). If the message persists, replace the memory card.
	Camera malfunction.	Contact a FUJIFILM dealer (pg. 100).
PROTECTED CARD	The memory card is locked.	Unlock the memory card (pg. 9).
BUSY	The memory card is incorrectly formatted.	Use the camera to format the memory card (pg. 77).

Warning	Description	Solution
CARD ERROR	The memory card is not formatted for use in the camera.	Format the memory card (pg. 77).
	The memory card contacts require cleaning or the memory card is damaged.	Clean the contacts with a soft, dry cloth. If the message is repeated, format the memory card (pg. 77). If the message persists, replace the memory card.
	Camera malfunction.	Contact a FUJIFILM dealer (pg. 100).
 MEMORY FULL	The memory card or internal memory is full; pictures can not be recorded or copied.	Delete pictures or insert a memory card with more free space.
 MEMORY FULL		
INTERNAL MEMORY IS FULL INSERT A NEW CARD		
WRITE ERROR	Memory card error or connection error.	Re-insert the memory card or turn the camera off and then on again. If the message persists, contact a FUJIFILM dealer (pg. 100).
	Not enough memory remaining to record additional pictures.	Delete pictures or insert a memory card with more free space.
	The memory card or internal memory is not formatted.	Format the memory card or internal memory (pg. 77).
READ ERROR	The file is corrupt or was not created with the camera.	The file can not be played back.
	The memory card contacts require cleaning.	Clean the contacts with a soft, dry cloth. If the message is repeated, format the memory card (pg. 77). If the message persists, replace the memory card.
	Camera malfunction.	Contact a FUJIFILM dealer (pg. 100).

Warning	Description	Solution
FRAME NO. FULL	The camera has run out of frame numbers (current frame number is 999-9999).	Format the memory card and select RENEW for the FRAME NO. option in the SETUP menu. Take a picture to reset frame numbering to 100-0001, then return to the FRAME NO. menu and select CONTINUOUS .
TOO MANY FRAMES	Date for which more than 4,999 pictures exist selected in sort-by-date view.	Choose a different date.
CAN NOT EXECUTE CAN NOT EXECUTE	Red-eye reduction can not be applied to the selected picture or movie.	—
PROTECTED FRAME	An attempt was made to delete or rotate a protected picture.	Remove protection before deleting or rotating pictures.
NO IMAGE	The source device selected in the playback COPY menu contains no pictures.	Select a different source.
NO IMAGE		
CAN NOT TRIM	An attempt was made to crop a picture.	These pictures can not be cropped.
CAN NOT TRIM	The picture selected for cropping is damaged or was not created with the camera.	
DPOF FILE ERROR	The DPOF print order on the current memory card contains more than 999 images.	Copy the pictures to internal memory and create a new print order.
CAN NOT SET DPOF	The picture can not be printed using DPOF.	—
CAN NOT SET DPOF	Movies can not be printed using DPOF.	—
CAN NOT ROTATE	The picture can not be rotated.	—
CAN NOT ROTATE	Movies can not be rotated.	—
COMMUNICATION ERROR	A connection error occurred while pictures were being printed or copied to a computer or other device.	Confirm that the device is turned on and that the USB cable is connected.

Warning	Description	Solution
PRINTER ERROR	Printer out of paper or ink, or other printer error.	Check printer (see printer manual for details). To resume printing, turn the printer off and then turn it back on.
PRINTER ERROR RESUME?		Check printer (see printer manual for details). If printing does not resume automatically, press MENU/OK to resume.
CAN NOT BE PRINTED	An attempt was made to print a movie, a picture not created with the camera, or a picture in a format not supported by the printer.	Movies and some pictures created with other devices can not be printed. If the picture was created with the camera, check the printer manual to confirm that the printer supports the JFIF-JPEG or Exif-JPEG format. If it does not, the pictures can not be printed.

Glossary

Digital zoom: Unlike optical zoom, digital zoom does not increase the amount of visible detail. Instead, details visible using optical zoom are simply enlarged, producing a slightly “grainy” image.

DPOF (Digital Print Order Format): A standard that allows pictures to be printed from “print orders” stored in internal memory or on a memory card. The information in the order includes the pictures to be printed and the number of copies of each picture.



EV (Exposure Value): The exposure value is determined by the sensitivity of the image sensor and the amount of light that enters the camera while the image sensor is exposed. Each time the amount of light doubles, EV increases by one; each time the amount of light is halved, EV decreases by one. The amount of light entering the camera can be controlled by adjusting aperture and shutter speed.

Exif Print: A standard that allows information stored with pictures to be used for optimal color reproduction during printing.

JPEG (Joint Photographic Experts Group): A compressed file format for color images. The higher the compression rate, the greater the loss of information and more noticeable drop in quality when the picture is displayed.

Motion JPEG: An AVI (Audio Video Interleave) format that stores images and sound in a single file, with the images recorded in JPEG format. Motion JPEG files can be played in QuickTime 3.0 or later.

Smear: A phenomenon specific to CCDs which causes white streaks to appear when very bright light sources, such as the sun or reflected sunlight, appear in the frame.

WAV (Waveform Audio Format): A standard Windows audio file format. WAV files have the extension “*.WAV” and may be compressed or uncompressed. The camera uses uncompressed WAV. WAV files can be played using Windows Media Player or QuickTime 3.0 or later.

White balance: The human brain automatically adapts to changes in the color of light, with the result that objects that appear white under one light source still appear white when the color of the light source changes. Digital cameras can mimic this adjustment by processing images according to the color of the light source. This process is known as “white balance.”

Flash Mode and Shooting Mode

The flash modes available depend on the shooting mode (pg. 29) and the option selected for FACE DETECTION.

■ FACE DETECTION: ON OFF or OFF

Flash mode	Shooting mode																			
																		TEXT		
AUTO	✓	—	✓	✓	✓	✓	—	✓	—	—	✓	✓	—	—	—	✓	—	—	—	✓
	✓	—	✓	✓	✓	✓	—	✓	—	—	✓	✓	—	—	—	✓	—	—	—	✓
	✓	✓	✓	—	✓	✓	✓	✓	✓	✓	✓	✓	✓	✓	✓	—	✓	✓	✓	✓
S↓	—	—	—	✓	—	✓	—	—	✓	—	—	—	—	—	—	—	—	—	—	✓

* Red-eye removal turns on automatically. See below.

■ FACE DETECTION: ON ON

Flash mode	Shooting mode																			
																		TEXT		
AUTO	✓	—	✓	✓	✓	✓	—	—	—	—	✓	✓	—	—	—	✓	—	—	—	✓
	✓	—	✓	✓	✓	✓	—	—	—	—	✓	✓	—	✓	—	—	—	—	—	✓
	✓	✓	✓	—	✓	✓	—	—	✓	✓	✓	✓	—	✓	—	—	✓	—	—	✓
SLOW	—	—	—	✓	—	✓	—	—	✓	—	—	—	—	—	—	—	—	—	—	✓

* Red-eye removal (ON ON) not available.

Internal Memory/Memory Card Capacity

















The following table shows the recording time or number of pictures available at different image qualities. All figures are approximate; file size varies with the scene recorded, producing wide variations in the number of files that can be stored. The number of exposures or length remaining may not diminish at an even rate.

	10M F	10M N	3:2	5M	3M	2M	03M	640	320	
Image size (pixels)	3648 × 2736		3648 × 2432	2592 × 1944	2048 × 1536	1600 × 1200	640 × 480	640 × 480	320 × 240	
File size	4.9 MB	2.5 MB	2.2 MB	1.2 MB	780 KB	630 KB	130 KB	—	—	
Internal memory (approx. 24 MB)	4	9	10	18	30	37	169	29 s	53 s	
SD card	512 MB	100	200	220	390	610	770	3430	9 min.	17 min.
	1 GB	200	400	450	780	1230	1540	6880	19 min.	35 min.
	2 GB	400	800	890	1540	2470	3090	12390	39 min.	71 min.
SDHC card	4 GB	810	1610	1790	3100	4960	6200	24820	79 min.*	143 min.*
	8 GB	1620	3230	3600	6220	9950	12440	47130	160 min.*	288 min.*

* Total length of all movie files. Individual movies can not exceed 2 GB in size.

Specifications

System	
Model	FinePix J100/FinePix J110w/FinePix J120/FinePix J150w digital camera
Effective pixels	10 million
CCD	½.3-in., square-pixel CCD with primary color filter
Storage media	<ul style="list-style-type: none"> • Internal memory (approx. 24 MB) • SD/SDHC memory cards (see page 9)
File system	Compliant with Design Rule for Camera File System (DCF), Exif 2.2, and Digital Print Order Format (DPOF)
File format	<ul style="list-style-type: none"> • Still pictures: Exif 2.2 JPEG (compressed) • Movies: Motion JPEG AVI
Image size (pixels)	<ul style="list-style-type: none"> • 10M F: 3,648 × 2,736 • 10M N: 3,648 × 2,736 • 3:2: 3,648 × 2,432 • 5M: 2,592 × 1,944 • 3M: 2,048 × 1,536 • 2M: 1,600 × 1,200 • 03M: 640 × 480
File size	See page 94
Lens (FinePix J100/J120)	Fujinon 5 × optical zoom lens, F/3.3 (wide angle)–5.1 (telephoto)
Focal length	f=6.3 mm–31.5 mm (35-mm format equivalent: 35 mm–175 mm, or 36.4 mm–182 mm at 3:2)
Lens (FinePix J110w/J150w)	Fujinon 5 × optical zoom lens, F/3.3 (wide angle)–5.1 (telephoto)
Focal length	f=5.1 mm–25.5 mm (35-mm format equivalent: 28 mm–140 mm, or 29.1 mm–145.6 mm at 3:2)
Digital zoom	Approx. 5.7 × (up to 28.5 × when combined with optical zoom)
Aperture (FinePix J100/J120)	F3.3 and F5.1 (wide angle), F5.1 and F8.0 (telephoto)
Aperture (FinePix J110w/J150w)	F3.3 and F5.2 (wide angle), F5.1 and F8.0 (telephoto)
Focus range (distance from front of lens) (FinePix J100/J120)	Approx. 60 cm (2 ft.)–infinity (wide angle); 1.5 m (4 ft. 11 in.)–infinity (telephoto) Macro mode: approx. 5 cm–80 cm/2.0 in.–2 ft. 7 in. (wide angle); 1 m–2 m/3 ft. 3 in.–6 ft. 7 in. (telephoto)
Focus range (distance from front of lens) (FinePix J110w/J150w)	Approx. 60 cm (2 ft.)–infinity (wide angle); 1.2 m (3 ft. 11 in.)–infinity (telephoto) Macro mode: approx. 5 cm–80 cm/2.0 in.–2 ft. 7 in. (wide angle); 80 cm–1.5 m/2 ft. 7 in.–4 ft. 11 in. (telephoto)
Sensitivity	Equivalent to ISO 64, 100, 200, 400, 800, 1600, 3200 (max. image size 3M); AUTO (Standard Output Sensitivity)
Metering	256-segment through-the-lens (TTL) metering; MULTI, SPOT, AVERAGE
Exposure control	Programmed autoexposure
Exposure compensation	–2 EV–+2 EV in increments of ⅓ EV (CM mode)

System	
Scene modes	 (digital zoom),  (red-eye reduction),  (baby mode),  (PORTRAIT),  (LANDSCAPE),  (SPORT),  (NIGHT),  (NATURAL LIGHT),  (BEACH),  (SNOW),  (FIREWORKS),  (SUNSET),  (FLOWER),  (PARTY),  (MUSEUM),  (TEXT)
Picture stabilization	Available
Intelligent Face Detection	Available
Shutter speed	1/4 s–1/2,000 s (AUTO mode); 8 s–1/2,000 s (other modes); combined mechanical and electronic shutter
Continuous	Up to three frames at a maximum of approximately 1.7 fps
Focus	<ul style="list-style-type: none"> • Mode: Single AF • Autofocus system: Contrast-detect TTL AF • Focus-area selection: AF CENTER
White balance	Automatic scene detection; six manual preset modes for direct sunlight, shade, daylight fluorescent, warm white fluorescent, cool white fluorescent, and incandescent lighting
Self-timer	Approx. 2 s and approx. 10 s
Flash (FinePix J100/J120)	Auto flash
Effective range (sensitivity set to ISO 400)	Approx. 60 cm–3 m/2 ft.–9 ft. 10 in. (wide angle), 1.5 m–1.9 m/4 ft. 11 in.–6 ft. 3 in. (telephoto) Macro mode: approx. 30 cm–80 cm/1 ft.–2 ft. 7 in. (wide angle); 1 m–1.9 m/3 ft. 3 in.–6 ft. 3 in. (telephoto)
Flash (FinePix J110w/J150w)	Auto flash
Effective range (sensitivity set to ISO 400)	Approx. 60 cm–3 m/2 ft.–9 ft. 10 in. (wide angle), 1.2 m–1.9 m/4 ft.–6 ft. 3 in. (telephoto) Macro mode: approx. 30 cm–80 cm/1 ft.–2 ft. 7 in. (wide angle); 70 cm–1.5 m/2 ft. 4 in.–5 ft. 11 in. (telephoto)
Flash modes	Auto, fill flash, off, slow sync (red-eye removal off); auto with red-eye reduction, fill flash with red-eye reduction, off, slow sync with red-eye reduction (red-eye removal on)
Monitor (FinePix J100/J110w)	2.7-in., 230k-dot amorphous silicon TFT color LCD monitor; frame coverage approx. 97%
Monitor (FinePix J120/J150w)	3.0-in., 230k-dot amorphous silicon TFT color LCD monitor; frame coverage approx. 97%
Movies	Camera can record movies with monaural sound and a frame size of 640 × 480 (640) or 320 × 240 (820) at a frame rate of 30 fps
Shooting options	Intelligent Face Detection with red-eye removal, best framing, and frame number memory
Playback options	Intelligent Face Detection with red-eye removal, micro thumbnail (FinePix J120/J150w only), multi-frame playback, sort-by-date, cropping (still pictures only), slide show, and image rotation

System	
Other options	PictBridge, Exif Print, language selection (Simplified Chinese, Traditional Chinese, Czech, Dutch, English, French, German, Hungarian, Italian, Japanese, Korean, Polish, Portuguese, Russian, Spanish, Swedish, and Turkish), time difference
Input/output terminals	
A/V OUT (audio/video output)	NTSC or PAL with monaural sound
Digital input/output	USB 2.0 High Speed with MTP/PTP connection
Power supply/other	
Power sources	NP-45 rechargeable battery
Battery life (NP-45)	Approx. 150 frames, based on CIPA (Camera and Imaging Products Association) standard; measured at 23°C (73°F) with the monitor on, pictures recorded to an SD memory card, the camera zoomed from widest angle to maximum zoom and back once every 30 s, the flash fired at full power with every other shot, and the camera turned off and then on again every 10 shots. Note that the number of shots that can be taken with a fully-charged battery varies with temperature and shooting conditions.
Camera dimensions	92 mm × 57.9 mm × 22.6 mm/3.6 in. × 2.3 in. × 0.9 in. (W × H × D), excluding projections
Camera weight (FinePix J100/J110w)	Approx. 141 g/5.0 oz., excluding battery, accessories, and memory cards
Camera weight (FinePix J120/J150w)	Approx. 146 g/5.1 oz., excluding battery, accessories, and memory cards
Shooting weight (FinePix J100/J110w)	Approx. 158 g/5.6 oz., including battery and memory card
Shooting weight (FinePix J120/J150w)	Approx. 163 g/5.7 oz., including battery and memory card
Operating conditions	<ul style="list-style-type: none"> • Temperature: 0°C – +40°C/+32°F – +104°F • Humidity: 10%–80% (no condensation)

NP-45 rechargeable battery	
Nominal voltage	DC 3.7V
Nominal capacity	740mAh
Operating temperature	0°C – +40°C/+32°F – +104°F
Dimensions (W × H × D)	31 mm × 39.4 mm × 5.7 mm/1.2 in. × 1.6 in. × 0.2 in.
Weight	Approx. 15 g/0.5 oz.
BC-45A battery charger	
Rated input	100–240V AC, 50/60 Hz
Input capacity	7.0VA (100V)/10.8VA (240V)
Rated output	4.2V DC, 550 mA
Supported batteries	NP-45 rechargeable batteries
Charging time	Approx. 100 minutes
Dimensions (W × H × D) (built-in plug model)	101.7 mm × 56 mm × 20 mm/4.0 in. × 2.2 in. × 0.8 in.
Dimensions (W × H × D) (power cable model)	85 mm × 54 mm × 20 mm/3.3 in. × 2.1 in. × 0.8 in.
Weight (built-in plug model)	Approx. 66 g/2.3 oz., excluding battery
Weight (power cable model)	Approx. 56 g/2.0 oz., excluding battery
Operating temperature	0°C – +40°C/+32°F – +104°F

Notes on the Battery and Battery Charger

- The battery and charger may become warm to the touch during charging. This is normal and does not indicate a malfunction. If possible, charge the battery in a well-ventilated location.
- The battery charger may vibrate when in use. This is normal and does not indicate a malfunction.
- The charger is for use with NP-45 batteries only.
- If the charger causes radio interference, increase the distance between the charger and the radio receiver.
- Do not leave the charger in locations that are very dusty or exposed to strong vibration, extreme humidity, or high temperatures (for example, in direct sunlight or next to a heater).
- The battery charger can be used with input voltages of 100–240V AC and 50 or 60 Hz. The shape of the plug varies with the country of sale; consult your travel agent to determine whether the charger can be used abroad.

Color Television Systems

NTSC (National Television System Committee) is a color television telecasting specification adopted mainly in the U.S.A., Canada, and Japan. PAL (Phase Alternation by Line) is a color television system adopted mainly in European countries and China.

Notices

- Specifications subject to change without notice. FUJIFILM shall not be held liable for damages resulting from errors in this manual.
- Although the monitor is manufactured using advanced high-precision technology, small bright points and anomalous colors (particularly in the vicinity of text) may appear. This is normal for this type of monitor and does not indicate a malfunction; images recorded with the camera are unaffected.
- Digital cameras may malfunction when exposed to strong radio interference (e.g., electric fields, static electricity, or line noise).
- Due to the type of lens used, some distortion may occur at the periphery of images. This is normal.

FUJIFILM Digital Camera Worldwide Network

Contact your local distributor (see list below) for repairs and technical support. Please present the warranty and purchase receipt when requesting repairs; refer to the warranty card for the conditions of the warranty. Technical support may not be available for models not handled by the local distributor. The following information is subject to change without notice.

NORTH AMERICA			
Canada	FUJIFILM Canada Inc.	Technical support	TEL 1-866-818-FUJI (3854) http://www.fujihelp.ca
		Repair service	TEL 1-800-263-5018 http://www.fujihelp.ca
U.S.A.	FUJIFILM U.S.A., Inc.	Technical support	TEL 800-800-3854 digitalinfo@fujifilm.com
		Repair service	TEL 800-659-3854
CENTRAL AND SOUTH AMERICA			
Argentina	Imagen e informacion S.A.	Technical support & repairs	TEL +54-11-4836-1000 servtec@imageneinformacion.com.ar
Bolivia	Reifschneider Bolivia Ltda.	Technical support & repairs	TEL +591 33 44 1129 gciagral@bibosi.scz.entelnet.bo
Brazil	FUJIFILM do Brasil Ltda.	Technical support & repairs	TEL 0800-12-8600 camarasdigitais@fujifilm.com.br
Chile	Reifschneider SA	Technical support & repairs	TEL 56-2-6781200 serviciotecnico@reifschneider.cl
Colombia	Animex de Colombia Ltda.	Technical support & repairs	TEL +57 1 338-0299 animex@etb.net.co
Ecuador	Espacri Cia Ltda	Technical support & repairs	TEL 593-72-835526
		Importaciones Espacri Cia. Ltda.	Technical support & repairs
Mexico	Fujifilm de Mexico, S.A. de C.V.	Technical support	TEL (52-55) 5263-55000 eizquierdo@fujifilm.com.mx
		Repair service	TEL (52-55) 5366-5150/56/57 cpalma@fujifilm.com.mx
Paraguay	Errece S.R.L.	Technical support & repairs	TEL +595 21 444256 jmarbulo@fujifilm.com.py
Peru	Procesos de Color S.A.	Technical support & repairs	TEL +51 14 33 5563 jalvarado@fujifilm.com.pe
Uruguay	Fotocamara S.R.L.	Technical support & repairs	TEL +598-2-9002004 fotocam@adinet.com.uy
Uruguay	Kiel S.A.	Technical support & repairs	TEL (05982) 419 4542 kiel@fujifilm.com.uy
Venezuela	C. Hellmund & Cia Sa	Technical support & repairs	TEL 0212-2022300 hellmund@hellmund.com
EUROPE			
Austria	Fuji Film Oesterreich	Technical support & repairs	TEL 0043 1 6162606/51 or 52 kamera.service@fujifilm.at
Belgium	Belgian Fuji Agency	Technical support & repairs	TEL 3210242090 info@fuji.be
Croatia	I&I d.o.o.	Technical support	TEL 38512319060 dsaravanja@fujifilm.hr
		Repair service	TEL 38512316228 info@fujifilm.hr

EUROPE

Cyprus	PMS IMAGING LTD	Technical support & repairs	TEL 35722746746 mariosashiotis@fujifilm.com.cy
	Doros Neophytou CAMERA REPAIRS	Technical support & repairs	TEL 35722314719 dorosn@logosnet.cy.net
Czech Republic	Fujifilm Cz., s.r.o.	Technical support	TEL 00420 234 703 411 fricman@fujifilm.cz
	AWH servis	Repair service	TEL 00420 222 721 525 awh@awh.cz
Denmark	Fujifilm Danmark A/S	Technical support & repairs	TEL 0045 45662244 fujifilm@fujifilm.dk
Finland	Fuji Finland Oy	Technical support & repairs	TEL +358 9 825951 www.fuji.fi fuji@fuji.fi
France	FUJIFILM France	Technical support & repairs	direction.technique@pm2s.fr
Germany	FUJIFILM Electronic Imaging Europe GmbH	Technical support & repairs	Tel 0180 / 589 89 80* <i>service@fujifilm-digital.com</i> *0,14 EUR pro Minute aus dem deutschen Festnetz, abweichende Preise aus Mobilfunknetzen möglich, Stand bei Drucklegung.
Greece	FUJIFILM HELLAS S.A.	Technical support & repairs	TEL 0030 210 9404100 fujifilm@fujifilm.gr
Hungary	Fujifilm Hungary Ltd.	Technical support	TEL 3612389410 fujifilm@fujifilm.hu
		Repair service	TEL 3613633777
Iceland	Icephoto (Ljosmyndavorur)	Technical support & repairs	TEL 354 568 0450 framkollun@fujifilm.is
Italy	FujiFilm Italia S.r.l.	Call center	TEL 039-0267978181 info@fujifilm.it
		Repair service	TEL 039-6058294 FAX 039-6058295
Lithuania	Fujifilm Lithuania	Technical support & repairs	TEL 370-5-2130121 info@fujifilm.lt
Malta	Ciancio (1913) Co.Ltd.	Technical support & repairs	TEL 0356-21-480500 info@fujifilm.com.mt
Norway	Fujifilm Norge AS	Technical support	TEL 0047-02273 http://www.fujifilm.no/ mailto:post@fujifilm.no
		Repair service	TEL 0047-55393880 http://www.camera.no/mailto:service@camera.no
Poland	Fujifilm Polska Distribution Sp. z o.o.	Technical support	TEL +48-22-517-66-00 fujifilm@fujifilm.pl
		Repair service	TEL +48-22-886-94-40 serwis@fujifilm.pl
Portugal	Fujifilm Portugal, Lda	Technical support	TEL (351) 226 194 237 finpix@fujifilm.pt
		Repair service	TEL (351) 226 194 200 cameras@fujifilm.pt
Romania	CTS-Cardinal Top Systems Ltd	Technical support & repairs	TEL 4021-230-09-82 cts_tirla@hotmail.com
Russia	ZAO "Fujifilm RU"	Technical support	TEL +7-495-956-98-58 info@fujifilm.ru
		Repair service	TEL +7-495-956-98-58 www.fujifilm.ru
Slovakia	Fujifilm Slovakia s.r.o.	Technical support	TEL 00421 2 33 595 107 fujifilm@fujifilm.sk
		Repair service	TEL 00421 2 33 595 119 servis@fujifilm.sk
Spain	Fujifilm Espana S.A.	Technical support & repairs	TEL 902012535 http://www.fujifilm.es/soporte/ tallersat@fujifilm.es

EUROPE

Sweden	Fujifilm Sverige AB	Technical support	TEL 46 8 506 141 70 kamera@fujifilm.se
		Repair service	TEL 46 8 506 513 54 kameraverkstaden@fujifilm.se
Switzerland / Lichtenstein	Fujifilm (Switzerland) AG	Technical support & repairs	TEL +41 44 855 5154 RepairCenter@fujifilm.ch
The Netherlands	FUJIFILM Electronic Imaging Nederland	Technical support	TEL +31(0)102812500 helpdesk@fujifilm-digital.nl
		Repair service	TEL +31(0)102812520 camerareparaties@fujifilm-digital.nl
Turkey	Fujifilm Turkiye Sinfo A.S.	Technical support	TEL +90 212 696 5090 csarp@fujifilm.com.tr
		Repair service	TEL +90 212 696 5090 servis@fujifilm.com.tr
U.K.	FUJIFILM UK Ltd.	Technical support	TEL +44 (0)8700 841310 fujitec@fuji.co.uk
		Repair service	TEL +44 (0)8700 841314 fujitec@fuji.co.uk
Ukraine	Image Ukraine CJSC	Technical support & repairs	TEL +380-44-4909075 d@fujifilm.ua

MIDDLE EAST

Iran	Tehran Fuka Co.	Technical support & repairs	TEL (+98-21)2254810-19 fuka@neda.net
Israel	Shimone Group Ltd.	Technical support	TEL (+) 972 3 9250666 digital@fujifilm.co.il
		Repair service	TEL (+) 972 3 9250666 khaim@shimone.com
Jordan	Grand Stores Al- Abdali, Amman / Jordan	Technical support & repairs	TEL 009626-4646387 gstores@go.com.jo
Lebanon	Fototek S.A.R.L.	Technical support & repairs	TEL +961 1 252474 fototek@antakiholding.com
		Techno Blue	TEL 00974 44 66 175 prabu@techno-blue.com
Saudi Arabia	Emam Distribution Co. Ltd.	Technical support	TEL 96626978756 service@fujifilm.com.sa
Syria	Film Trading Company	Technical support	TEL + 963 11 2218049 ft.c@Net.SY
		Repair service	TEL + 963 21 4641903 filmtradin@Net.SY
U.A.E.	Grand Stores	Technical support & repairs	TEL + 971-4-2823700 photography@grandstores.ae
Yemen	Al-Haidary Trading	Technical support	TEL 00967-1-503980
		Repair service	TEL 00967-1-503977

AFRICA

Egypt	Foto Express Egypt	Technical support & repairs	TEL (202) 7762062 fotoegypt@access.com.eg
Kenya	Fuji Kenya Ltd	Repair service	TEL (254-20)4446265-8 info@fujifilm.co.ke
South Africa	Cameratek CC.	Technical support & repairs	TEL +27 11 251 2400 www.cameratek.co.za

OCEANIA

Australia	FUJIFILM Australia Pty Ltd	Technical support & repairs	TEL 1800 226 355 digital@fujifilm.com.au
Fiji	Brijjal & Co. Ltd	Technical support & repairs	TEL (679)3304133 kapadia@connect.com.fj
New Caledonia	Phocidis SARL	Technical support & repairs	TEL (00 687) 25-46-35 phocidis@phocidis.nc

OCEANIA

New Zealand	Fujifilm NZ Ltd	Technical support & repairs	TEL +64-9-4140400 glenn.beaumont@fujifilm.co.nz
Papua New Guinea	Oceania PNG Limited	Technical support	TEL +675 3256411 oceania@daltron.com.pg

ASIA

Hong Kong	Fuji Photo Products Co., Ltd.	Technical support & repairs	TEL (852)2406 3287 rsd@chinahkphoto.com.hk
Indonesia	PT. Modern Internasional, Tbk.	Technical support & repairs	TEL +62 021 45867187 assd_kmrsrv@modernphoto.co.id
Malaysia	FUJIFILM (Malaysia) Sdn. Bhd.	Technical support Repair service	TEL 603-55698388 technical@fujifilm.com.my TEL 603-55698388 camera@fujifilm.com.my
Philippines	YKL Development & Trdg. Corp.	Technical support Repair service	TEL 632-7436601~06 info@yklcolor.com digital@yklcolor.com TEL 632-7436601~06 techop_services@yklcolor.com
Singapore	FUJIFILM (Singapore) Pte Ltd	Technical support & repairs	TEL 65-6380 5557 service@fujifilm.com.sg
South Korea	Korea Fujifilm Co., Ltd.	Technical support	TEL +82-2-3282-7363 photo@fujifilm.co.kr
	Yonsan AS Center (Fujidigital)	Repair service	TEL +82-2-701-1472 1bowl@hanmail.net
	Kangnam AS Center (Digitalgallery)	Repair service	TEL +82-2-2203-1472 nurjilli@hanmail.net
	Busan AS Center (Digital-Sewon)	Repair service	TEL +82-51-806-1472 merahan@yahoo.co.kr
Taiwan	Hung Chong Corp.	Technical support & repairs	TEL 886-2-6602-8988 dah@mail.hungchong.com.tw
Thailand	FUJIFILM (Thailand) Ltd.	Technical support Repair service	TEL +662-2706000 ext. 751,752 Dusit_Suriyong@fujifilm.co.th yaowarat@fujifilm.co.th TEL +662-2706000 ext.761,762 warin@fujifilm.co.th
Vietnam	International Minh Viet Co., Ltd.	Technical support & repairs	TEL +84-8-4135740 ext. 322 diep.phanthithanh@imv.com.vn

IMPORTANT NOTICE: Read Before Using the Software

BEFORE OPENING THE CD-ROM PROVIDED BY FUJIFILM CORPORATION, PLEASE READ THIS END USER LICENSE AGREEMENT CAREFULLY. YOU SHOULD USE THE SOFTWARE ON THE CD-ROM ONLY IF YOU CONSENT TO THIS AGREEMENT. BY OPENING THE PACKAGE, YOU ACCEPT AND AGREE TO BE BOUND BY THIS AGREEMENT.

End User License Agreement

This End User License Agreement ("Agreement") is an agreement between FUJIFILM Corporation ("FUJIFILM") and you, which sets forth the terms and conditions of the license granted for you to use the software provided by FUJIFILM.

The CD-ROM contains third-party software. In case a separate agreement is provided by a third party supplier for its software, the provisions of such separate agreement shall apply to the use of such third party software, prevailing over those of this Agreement.

1. Definitions.

- "Media" means the CD-ROM titled "Software for FinePix" which is provided to you together with this Agreement.
- "Software" means the software which is recorded on Media.
- "Documentation" means the operation manuals of Software and other related written materials which are provided to you together with Media.
- "Product" means Media (including Software) and Documentation collectively.

2. Use of Software.

FUJIFILM grants to you a nontransferable, nonexclusive license:

- to install one copy of Software onto one computer in binary machine executable form;
- to use Software on the computer onto which Software is installed; and
- to make one backup copy of Software.

3. Restrictions.

- You shall not distribute, rent, lease or otherwise transfer all or any part of Software, Media or Documentation to any third party without FUJIFILM's prior written consent. You also shall not sublicense, assign or otherwise transfer all or any part of the rights granted to you by FUJIFILM under this Agreement without FUJIFILM's prior written consent.
- Except as expressly granted by FUJIFILM hereunder, you shall not copy or reproduce all or any part of Software or Documentation.
- You shall not alter, adapt or translate Software or Documentation. You also shall not alter or remove copyright and other proprietary notices that appear on or in Software or Documentation.
- You shall not, or shall not have any third party, reverse-engineer, decompile, or disassemble Software.

4. Ownership.

All copyrights and other proprietary rights to Software and Documentation are owned and retained by FUJIFILM or the third party suppliers as indicated on or in Software or Documentation. Nothing contained herein shall be construed, expressly or implicitly, as transferring or granting any right, license, or title to you other than those explicitly granted under this Agreement.

5. Limited Warranty.

FUJIFILM warrants to you that Media is free from any defect in material and workmanship under normal use for ninety (90) days from the date of your receipt of Media. Should Media not meet the foregoing warranty, FUJIFILM shall replace such defective Media with other Media bearing no defect. FUJIFILM's entire liability and your sole and exclusive remedy with regard to any defect in Media shall be expressly limited to such FUJIFILM's replacement of Media as provided herein.

6. DISCLAIMER OF WARRANTY.

EXCEPT AS PROVIDED IN SECTION 5 HEREIN, FUJIFILM PROVIDES PRODUCT "AS IS" AND WITHOUT WARRANTIES OF ANY KIND, EXPRESS OR IMPLIED. FUJIFILM SHALL MAKE NO WARRANTY, EXPRESS, IMPLIED OR STATUTORY, AS TO ANY OTHER MATTERS, INCLUDING, BUT NOT LIMITED TO NON-INFRINGEMENT OF ANY COPYRIGHT, PATENT, TRADE SECRET, OR ANY OTHER PROPRIETARY RIGHTS OF ANY THIRD PARTY, MERCHANTABILITY, OR FITNESS FOR ANY PARTICULAR PURPOSE.

7. LIMITATION OF LIABILITY.

IN NO EVENT SHALL FUJIFILM HAVE ANY LIABILITY FOR ANY GENERAL, SPECIAL, DIRECT, INDIRECT, CONSEQUENTIAL, INCIDENTAL, OR OTHER DAMAGES (INCLUDING DAMAGES FOR LOSS OF PROFITS OR LOST SAVINGS) INCURRED FROM THE USE OF OR INABILITY TO USE PRODUCT EVEN IF FUJIFILM HAS BEEN ADVISED OF THE POSSIBILITY OF SUCH DAMAGES.

8. No export.

You acknowledge that neither Software nor any part thereof, will be transferred, or exported to any country or used in any manner in violation of any export control laws and regulations to which Software is subject.

9. Termination.

In case you breach any of the terms and conditions hereof, FUJIFILM may immediately terminate this Agreement without any notice.

10. Term.

This Agreement is effective until the date when you cease to use Software, unless earlier terminated in accordance with Section 9 hereof.

11. Obligation upon termination.

Upon termination or expiration of this Agreement, you shall, at your own responsibility and expense, delete or destroy immediately all Software (including its copies, Media and Documentation).

12. Governing Law.

This Agreement shall be governed by and construed in accordance with laws of Japan.

FUJIFILM

FUJIFILM Corporation

7-3, AKASAKA 9-CHOME, MINATO-KU, TOKYO 107-0052, JAPAN

http://www.fujifilm.com/products/digital_cameras/index.html