



LEICA V-LUX 1

Instructions

Dear Customer,

We would like to take this opportunity to thank you for purchasing this LEICA V-LUX 1. Please read these Operating Instructions carefully and keep them handy for future reference.

Information for Your Safety

WARNING

TO REDUCE THE RISK OF FIRE OR SHOCK HAZARD AND ANNOYING INTERFERENCE, USE ONLY THE RECOMMENDED ACCESSORIES AND DO NOT EXPOSE THIS EQUIPMENT TO RAIN OR MOISTURE. DO NOT REMOVE THE COVER (OR BACK); THERE ARE NO USER SERVICEABLE PARTS INSIDE. REFER SERVICING TO QUALIFIED SERVICE PERSONNEL.

Carefully observe copyright laws. Recording of pre-recorded tapes or discs or other published or broadcast material for purposes other than your own private use may infringe copyright laws. Even for the purpose of private use, recording of certain material may be restricted.



QuickTime and the QuickTime logo are trademarks or registered trademarks of Apple Computer, Inc., used under license.



A lithium ion/polymer battery that is recyclable powers the product you have purchased. Please call 1-800-8-BATTERY for information on how to recycle this battery.

- Please note that the actual controls and components, menu items, etc. of your LEICA V-LUX 1 may look somewhat different from those shown in the illustrations in these Operating Instructions.
- SDHC Logo is a trademark.
- Leica is a registered trademark of Leica Microsystems IR GmbH.
- Elmarit is a registered trademark of Leica Camera AG.
- Other names, company names, and product names printed in these instructions are trademarks or registered trademarks of the companies concerned.

THE SOCKET OUTLET SHALL BE INSTALLED NEAR THE EQUIPMENT AND SHALL BE EASILY ACCESSIBLE.

CAUTION

Danger of explosion if battery is incorrectly replaced. Replace only with the same or equivalent type recommended by the manufacturer. Dispose of used batteries according to the manufacturer's instructions.

FCC Note: (U.S. only)

This equipment has been tested and found to comply with the limits for a Class B digital device, pursuant to Part 15 of the FCC Rules. These limits are designed to provide reasonable protection against harmful interference in a residential installation. This equipment generates, uses, and can radiate radio frequency energy and, if not installed and used in accordance with the instructions, may cause harmful interference to radio communications. However, there is no guarantee that interference will not occur in a particular installation. If this equipment does cause harmful interference to radio or television reception, which can be determined by turning the equipment off and on, the user is encouraged to try to correct the interference by one or more of the following measures:

- Reorient or relocate the receiving antenna.
- Increase the separation between the equipment and receiver.
- Connect the equipment into an outlet on a circuit different from that to which the receiver is connected.
- Consult the dealer or an experienced radio/TV technician for help.

FCC Caution: To assure continued compliance, follow the attached installation instructions and use only shielded interface cables with ferrite core when connecting to computer or peripheral devices.

Any changes or modifications not expressly approved by the party responsible for compliance could void the user's authority to operate this equipment.

Trade Name: LEICA

Model No.: V-LUX 1

Responsible party / Support Contact:

Leica Camera AG

Oskar-Barnack-Str. 11

D-35606 Solms

Tel.: +49 (0) 64 42-208-0

Fax: +49 (0) 64 42-208-333

www.leica.camera.com

info@leica-camera.com

This device complies with Part 15 of the FCC Rules. Operation is subject to the following two conditions: (1) This device may not cause harmful interference, and (2) this device must accept any interference received, including interference that may cause undesired operation.

This Class B digital apparatus complies with Canadian ICES-003



-If you see this symbol-

Information on Disposal in other Countries outside the European Union

This symbol is only valid in the European Union.

If you wish to discard this product, please contact your local authorities or dealer and ask for the correct method of disposal.



■ Care of the camera

- **Do not strongly shake or bump the camera.** The camera may stop operating normally, pictures may not be recorded or the lens may be damaged.
- **Sand or dust may cause the camera to malfunction. Make sure that sand or dust does not get into the lens or the terminals when using the camera on a beach etc.**
- Make sure that water does not get into the camera when using it on a rainy day or on a beach.
- **If water or seawater splashes on the camera, use a dry cloth to wipe the camera body carefully.**

■ About the LCD monitor/Viewfinder

- **Do not press the LCD monitor with excessive force. Uneven colors may appear on the LCD monitor and it may malfunction.**
- Condensation may form on the LCD monitor in places with large temperature differences. Wipe the condensation with a soft, dry cloth.
- If the camera is cold when you turn it on, the picture on the LCD monitor/Viewfinder will be slightly darker than usual at first. However, the picture will return to normal brightness when the internal temperature of the camera increases.
- **When rotating the LCD monitor, be careful not to use excessive force. This may result in damage.**
- **You may not be able to open, close or rotate the LCD monitor smoothly when using a tripod. In these cases, detach the camera from the tripod and then open, close or rotate the LCD monitor.**
- When not using the LCD monitor or when using the Viewfinder, it is recommended that you close the LCD monitor with the screen facing inwards to prevent dirt and scratches.
- If the camera is going to be stored for a prolonged period, it is recommended that the LCD monitor be stored inside the camera.

Extremely high precision technology is employed to produce the LCD monitor/Viewfinder screen. However there may be some dark or bright spots (red, blue or green) on the screen. This is not a malfunction. The LCD monitor/Viewfinder screen has more than 99.99% effective pixels with a mere 0.01% of the pixels inactive or always lit. The spots will not be recorded on pictures on a card.

■ About the Lens

- Do not press the lens with excessive force.
- Do not leave the camera with the lens facing the sun as it may cause the camera to malfunction. Also, be careful when you leave the camera outside or near a window.
- When there is dirt (water, oil, and fingerprints, etc.) on the surface of the lens, the picture may be affected. Lightly wipe the surface of the lens with a soft, dry cloth before and after taking pictures.

■ About Condensation (When the lens or the Viewfinder is fogged up)

- Condensation occurs when the ambient temperature or humidity changes as described below. Be careful of condensation since it causes lens stains, fungus and camera malfunction.
 - When the camera is taken from the cold outdoors to the warm indoors.
 - When the camera is taken from outside to inside an air-conditioned car.
 - When cool wind from an air conditioner etc. blows directly on the camera.
 - In humid places
- To prevent condensation, put the camera in a plastic bag until the temperature of the camera is close to the ambient temperature. If condensation occurs, turn the camera off and leave it for about 2 hours. The fog will disappear naturally when the temperature of the camera becomes close to the ambient temperature.

■ When not using the camera for a long period of time

- Store the battery in a cool and dry place with a relatively stable temperature.
[Recommended temperature: 15 °C to 25 °C (59 °F to 77 °F),
Recommended humidity: 40% to 60%]
- Always remove the battery and the card from the camera.
- If the battery is left inserted in the camera it will discharge even if the camera is turned off. If the battery continues to be left in the camera, it will discharge excessively and may become unusable even if charged.
- When storing the battery for a long period of time, we recommend charging it once a year. Remove the battery from the camera and store it again after it has completely discharged.
- We recommend storing the camera with a desiccant (silica gel) when you keep it in a closet or a cabinet.
- **If you have not used the camera for a long period of time, check all the parts before taking pictures.**

About The Mode Dial

Adjust part **A** to the desired mode.
The mode dial can be rotated 360°. Rotate it slowly and surely to adjust to each mode.

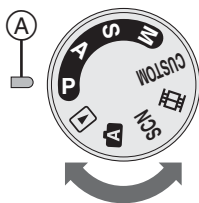

P : Program AE mode (P32)

The exposure is automatically adjusted by the camera.

A : Aperture-priority AE mode (P57)

The shutter speed is automatically determined by the aperture value you set.

S : Shutter-priority AE mode (P57)

The aperture value is automatically determined by the shutter speed you set.

M : Manual exposure mode (P58)

The exposure is adjusted by the aperture value and the shutter speed which are manually adjusted.

CUSTOM: Custom mode (P63)

This mode allows you to save the preferred menu settings.

Movie : Motion picture mode (P76)

This mode allows you to record motion pictures.

SCN : Scene mode (P64)

This mode allows you to take pictures depending on the recording scenes.

A : Auto mode (P36)

This mode is recommended for beginners.

Play : Playback mode (P40)

This mode allows you to play back recorded pictures.

■ About indications in these operating instructions



Modes indicated here allow you to use the functions or settings described on this page. Set the mode dial to any of the modes to use the functions or settings.

C : Custom mode



Convenient or helpful information for use of the camera is described.

■ About illustrations in these operating instructions

Please note that the appearance of the product, the illustration or the menu screen are a little different from those in actual use.

■ About illustrations of the cursor button

In these operating instructions, the operations on the cursor button are described as illustrated as shown below.

Cursor button

e.g.: When you press the ▼ button

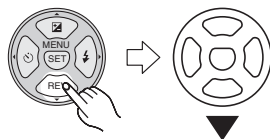

■ About the front dial and rear dial

Instructions for using these dials in the operating instructions are given with illustrations that match the screen icons.

- Rotate the front dial and rear dial slowly but surely.

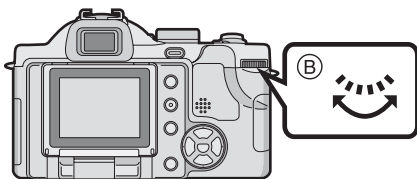
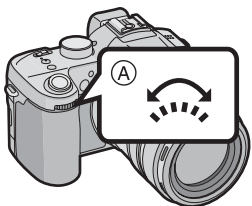

Ⓐ: Front dial

Ⓑ: Rear dial

■ About the LCD monitor

At the time when this camera is purchased, the LCD monitor is stowed in the camera body. Move the LCD monitor in the directions shown in the figure below.

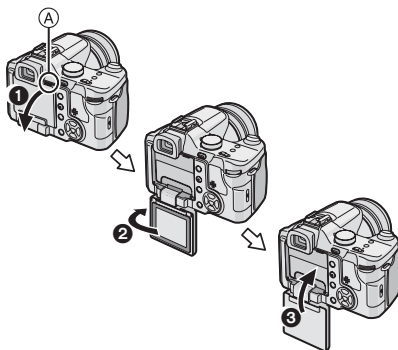

Ⓐ: LCD Monitor open knobs

- 1 Open the LCD monitor opening knob with your finger
- 2 Rotate the monitor 180° toward the left
 - The monitor rotates only 90° toward the right.
- 3 Return the monitor to its original position
 - For details on how to rotate the LCD monitor, refer to P24.

Before Use

Information for Your Safety	2
About The Mode Dial	6

Preparation

Scope of Delivery.....	10
Names of the Components	10
Quick Guide	12
Screen Display.....	13
Charging the Battery with the Charger	16
About the Battery (charging/number of recordable pictures)	16
Inserting/Removing the Battery	18
Inserting/Removing the Card	19
About the Card.....	20
Attaching the Lens Cap/Strap.....	21
Attaching the Lens Hood	22
LCD Monitor.....	24
Setting Date/Time (Clock Set)	26
About the Setup Menu	27

Basic

Taking Pictures	32
Taking Pictures in Auto Mode.....	36
Taking Pictures with the Zoom	37
• Using the Optical Zoom	37
• Using the Extended Optical Zoom (EZ).....	37
• Using the Digital Zoom Further extending the zoom	38
Checking the Recorded Picture (Review)	39
Playing Back Pictures	40
Deleting Pictures.....	41

Advanced

About the LCD Monitor/Viewfinder	43
• Changing the information displayed	43
Taking Pictures using the Built-in Flash	47
Taking Pictures with the Self-timer	51
Compensating the Exposure	52

Taking Pictures using Auto Bracket.....	53
Optical Image Stabilizer.....	54
Taking Pictures using Continuous Mode	55
Taking Close-up Pictures.....	56
Aperture-priority mode	57
Shutter-priority mode	57
Manual exposure	58
Aperture Value and Shutter Speed.....	59
Taking Pictures with Manual Focus	60
Registering Personal Menu Settings (Registering custom settings).....	62
Taking pictures in Custom mode	63
Scene Mode.....	64
– [PORTRAIT]	65
– [SOFT SKIN]	65
– [SCENERY]	65
– [SPORTS].....	65
– [NIGHT PORTRAIT].....	66
– [NIGHT SCENERY].....	66
– [PANNING].....	66
– [FOOD].....	67
– [PARTY]	67
– [CANDLE LIGHT]	68
– [FIREWORKS].....	68
– [STARRY SKY].....	68
– [BABY1]/[BABY2]	69
– [SNOW]	70
– [HIGH SENS.].....	70

Recording which day of the vacation you take the picture	71
Displaying the time at the travel destination (World Time)	73
• Location candidates for World Time settings.....	75
Motion Picture Mode	76
Displaying Multiple Images (Multi Playback).....	78
Displaying pictures by recording date (Calendar playback)	79
Using the Playback Zoom	80
Playing Back Motion Pictures/ Pictures with Audio.....	81







Menu Settings

Using the [REC] Mode Menu	82
• [W.BALANCE] Adjusting the hue for a more natural picture.....	83

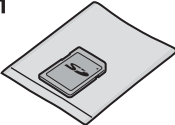
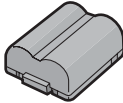
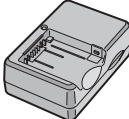
• [WB ADJUST.] Finely adjusting the white balance	85	• [ROTATE DISP.]/[ROTATE] To display the picture rotated	104
• [SENSITIVITY] Setting the light sensitivity	85	• [DPOF PRINT] Setting the picture to print and the number of prints.....	105
• [ASPECT RATIO] Setting the aspect ratio of pictures ...	87	• [PROTECT] Preventing accidental erasure of pictures.....	107
• [PICT.SIZE]/[QUALITY] Setting a picture size and quality that matches your use of the pictures	87	• [AUDIO DUB.] Adding audio after taking pictures.....	108
• [AUDIO REC.] Recording still pictures with audio	89	• [RESIZE] Making the picture smaller.....	108
• [METERING MODE] Deciding the method to measure brightness.....	89	• [TRIMMING] Enlarging a picture and trimming it.....	109
• [AF MODE] Setting the focus method.....	90	• [ASPECT CONV.] Changing the aspect ratio of a 16:9 picture.....	110
• [CONT.AF] Continuously focusing on a subject	91	• [FORMAT] Initializing the card.....	111
• [AF ASSIST LAMP] Focusing in low light conditions becomes easier	91		
• [FOCUS/AE LOCK] Fixing the focus and exposure	92	<hr/> <hr/> Connecting to other equipment <hr/> <hr/>	
• [DIREC. EX. COMP.] For rapid exposure compensation	93	Connecting to a PC.....	112
• [COL.EFFECT] Setting color effects for the recorded pictures.....	94	Printing the Pictures.....	115
• [PICT.ADJ.] Adjusting the picture quality for the recorded pictures.....	94	Playing Back Pictures on a TV Screen	118
• [FLIP ANIM.] Connecting images to create a motion picture file	95		
• [CONVERSION] Using an optional lens attachment ...	97	<hr/> <hr/> Others <hr/> <hr/>	
• [EXT.FLASH] Using an optional flash	99	Using Filters.....	119
• [EX.FLASH BURST] Taking pictures in continuous mode while firing the flash	101	Using the Remote Control Unit	120
• [CLOCK SET] Set the date, time and display	101	Cautions for Use	121
Using the [PLAY] mode menu	102	Message Display	123
• [SLIDE SHOW] Playing back pictures in order for a fixed duration.....	102	Troubleshooting	124
• [FAVORITE] Setting your favorite pictures.....	103	Number of recordable pictures and available recording time	129
		Specifications.....	132
		Accessories	135
		Installing the Software on the CD	136
		AC Mains Great Britain	138
		Index	139
		Leica Academy	142
		Leica on the Internet	142
		Leica Information Service	143
		Leica Customer Service.....	143

Scope of Delivery

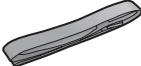
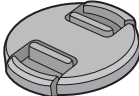
Check that all the accessories are included before using the camera.

<p>1</p>  <p>423-075.801-084</p>	<p>2 BP-DC5-E/U/J</p>  <p>18 654/-655/-656</p>
<p>3 BC-DC5-E/U/J/T</p>  <p>423-075.801-085/ -086/-087/-088</p>	<p>4</p>  <p>TW 423-075.801-083 EU 423-068.801-019 UK -020 / US -021 JP -022 / AUS -023</p>
<p>5</p>  <p>423-068.801-017</p>	<p>6</p>  <p>423-068.801-016</p>
<p>7</p> 	<p>8</p>  <p>423-075.801-081</p>
<p>9</p>  <p>423-075.801-013</p>	
<p>10</p>  <p>423-075.801-082</p>	

- 1** SD Memory Card (512 MB)
(Indicated as "Card" in the text)
- 2** Battery Pack BP-DC5
(Indicated as "Battery" in the text)
- 3** Battery Charger BC-DC5
(Indicated as "Charger" in the text)

- 4** AC Cable
- 5** USB Connection Cable
- 6** AV Cable
- 7** CD-ROM
- 8** Shoulder Strap
- 9** Lens Cap
- 10** Lens Hood

• For information about optional accessories, refer to the "Accessories". (P135)

Names of the Components

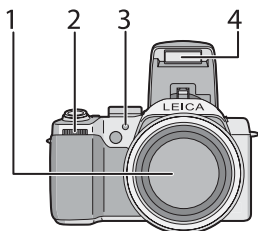

- 1** Lens (P5)
- 2** Front dial (P39, 40, 57, 78, 80)
- 3** Self-timer Indicator (P51)
AF Assist Lamp (P91)
- 4** Flash (P47)

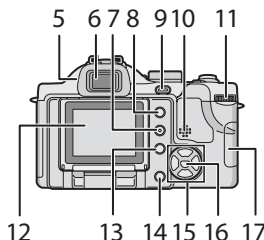

- 5 Diopter Adjustment Dial (P44)
- 6 Viewfinder (P13, 43)
- 7 [DISPLAY] Button (P43)
- 8 [EVF/LCD] Button (P43)
- 9 [FOCUS/AE LOCK] Button (P35, 92)
- 10 Speaker (P81)
- 11 Rear dial (P33, 40, 57, 58)
- 12 LCD Monitor (P13, 24, 43)
- 13 [FUNCTION] Button (P83)
- 14 Delete Button (P41)
- 15 Cursor Buttons
 - ◀/Self-timer Button (P51)
 - ▼/[REV] Button (P39)
 - ▶/Flash Setting Button (P47)
 - ▲/Exposure Compensation (P52)/Auto Bracket (P53)/Flash Output Adjustment (P49)/Backlight Compensation in auto mode (P36) Button
- 16 [MENU/SET] Button (P27)
- 17 Card Door (P19)

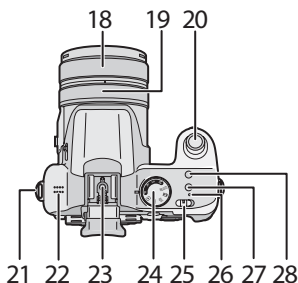

- 18 Zoom ring (P37)
- 19 Focus ring (P60)
- 20 Shutter Button (P32)
- 21 Strap Eyelet (P21)
- 22 Microphone (P76, 89)
- 23 Hot Shoe (P99)
- 24 Mode Dial (P6)
- 25 Camera ON/OFF Switch (P26)
- 26 Power Indicator (P32)
- 27 Single or Continuous Mode Button (P55)
- 28 Optical Image Stabilizer Button (P54)

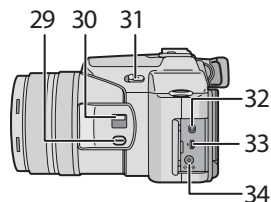

- 29 [FOCUS] Button (P61,68, 90)
- 30 Focus Switch (P56, 60)
(AF/AF MACRO/MF)
- 31 Flash Open Lever (P47)
- 32 [REMOTE] Socket (P120)
- 33 [AV OUT/DIGITAL] Socket
(P112, 115, 118)
- 34 [DC IN] Socket (P112, 115)
 - Always use a genuine Leica AC adaptor (ACA-DC5; optional).

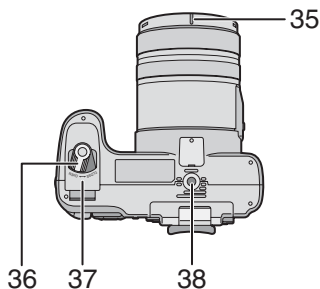

- 35 Lens hood positioning groove (P22)
- 36 Battery Door Open/Close Lever (P18)
- 37 Battery Door (P18)
- 38 Tripod Thread
 - When you use a tripod, make sure the tripod is stable with the camera attached to it.

Quick Guide

This is an overview of how to record and playback pictures with the camera. For each step, be sure to refer to the pages indicated in brackets.

1 Charge the battery. (P16)

A. Only U.S. and Japan

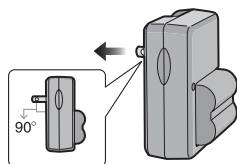

B. Other countries

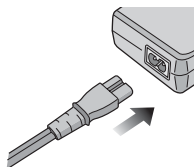

• The battery is not charged when the camera is shipped. Charge the battery before use.

2 Insert the battery and the card. (P18, 19)

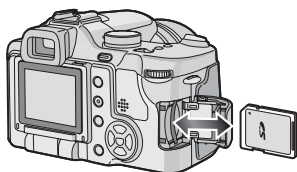
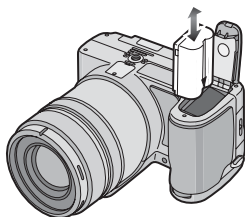

3 Turn the camera on to take pictures.

• Set the clock. (P26)

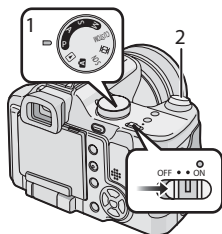

- 1 Set the mode dial to [P].
- 2 Press the shutter button to take pictures. (P32)

4 Play back the pictures.

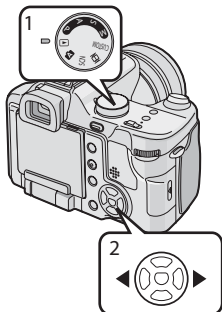

- 1 Set the mode dial to [▶].
- 2 Select the picture you want to view. (P40)

Screen Display

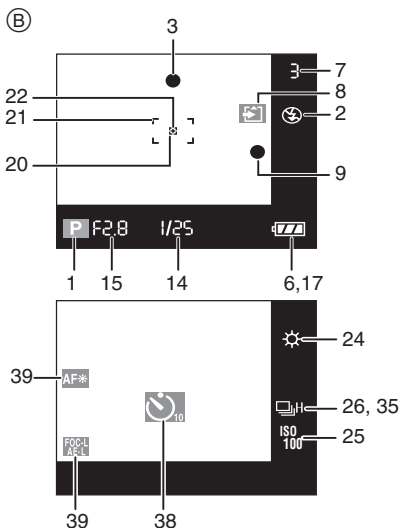
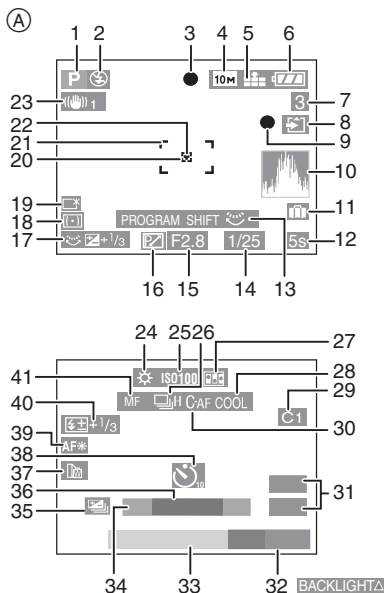



(A) In recording

(B) Out-of-frame display

- 1 Recording mode (P32)
- 2 Flash mode (P47)
- 3 Focus (P32)
- 4 Picture size (P87)
- 5 Quality (P87)
In Motion picture mode (P76)

30fps VGA	10fps VGA	30fps QVGA	10fps QVGA	30fps 16:9
10fps 16:9				
- 6 Battery indication (P16)
- 7 Number of recordable pictures/
Available recording time
In Motion picture mode (P76)
e.g.: **R1h20m30s**
- 8 Card access indication (P20)
- 9 Recording state
- 10 Histogram (P46)
- 11 Travel date (P71)
- 12 Elapsed recording time (P76)
- 13 Program shift (P33)
- 14 Shutter speed (P32)
I ISO: Intelligent ISO (P85)
- 15 Aperture value (P32)
- 16 Program shift (P33)
- 17 Exposure compensation (P52)
Direct exposure compensation (P93)
B: Backlight compensation (P36)
- 18 Metering mode (P89)
- 19 **P**: Power LCD (P45)
- 20 Spot AF area (P90)
- 21 AF area (P32)
- 22 Spot metering target (P89)
- 23 Optical image stabilizer (P54)

- 24 White balance (P83)
White balance fine adjustment (P85)
- 25 ISO sensitivity (P85)
- 26 Continuous (P55)
 : Audio recording (P76, 89)
- 27 Flip animation (P95)
- 28 Color effect mode (P94)
- 29 Custom setting (P62)
- 30 Continuous AF (P91)
- 31 Zoom (P37)/Extended optical zoom (P37)/Digital zoom (P38)
- 32 Operation for backlight compensation (P36)
- 33 Current date and time
 - This is displayed for about 5 seconds when the camera is turned on, after setting the clock and after switching from playback mode to recording mode.
- 34 Age (P69)
 - This is displayed for about 5 seconds when the camera is turned on in baby mode, after setting the clock or birthday, and after switching from other modes to baby mode.
- 35 Auto bracket (P53)
- 36 Number of days that have passed since the travel date (P71)
 - This is displayed for about 5 seconds if the camera is turned on when the travel date is set, after setting the clock, departure date or travel date, after changing the world time setting and after switching from playback mode to another mode.
- 37 Lens attachment (P97)
- 38 Self-timer mode (P51)
- 39 AF assist lamp (P91)
 : FOCUS/AE LOCK (P92)
- 40 Flash output adjustment (P49)
- 41 MF (P60)
AF MACRO (P56): 

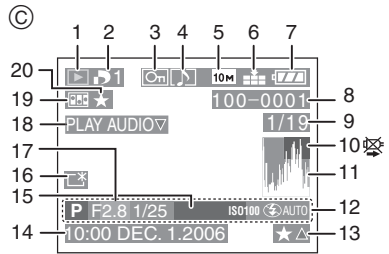

© In playback

- Playback mode (P40)
- Number of DPOF prints (P105)
- Protected picture (P107)
- Picture with audio/Motion pictures (P81)
- Picture size (P87)
- Quality (P87)
 - In Motion picture mode (P81)
- Battery indication (P16)
- Folder/File number (P113)
- Picture number/Total pictures
- Cable disconnection warning icon (P118)
 - This is displayed when printing using a printer supporting PictBridge. (Depending on the printer, the icon may not be displayed.)
- Motion picture recording time (P81): **1h20m30s**
- Histogram (P46)
- Recording information
- Favorites settings (P103)/Elapsed playback time (P81): **1h20m30s**
- Recorded date and time
- Age (P69)
- Power LCD (P45)

- 17 Number of days that have passed since the travel date (P71)
- 18 Audio playback (P81)
 - PLAY MOTION**
 - PICTURE** : In motion picture mode (P81)
- 19 Flip animation (P95)
- 20 Favorites (P103)

Charging the Battery with the Charger

The battery is not charged when the camera is shipped. Charge the battery before use.

1 Insert the battery terminals and attach the battery to the charger.

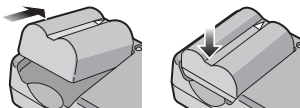

2 Connect the charger to the electrical outlet.

A. Only U.S. and Japan

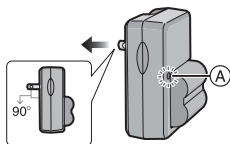

B. Other countries

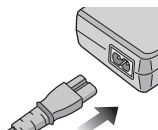

- Charging starts when the [CHARGE] indicator (A) lights green.
- If the [CHARGE] indicator blinks, refer to P17.

3 Detach the battery after charging is complete.

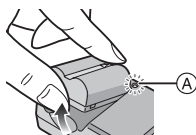

- Charging is complete when the [CHARGE] indicator (A) turns off (after about 120 minutes).



- After charging is completed, be sure to disconnect the charger from the electrical outlet.
- The battery becomes warm after using it and during and after charging. The camera also becomes warm during use. This is not a malfunction.
- The battery will be exhausted if left for a long period of time after being charged. Recharge the battery when it is exhausted.
- Use the dedicated charger and battery.
- Charge the battery with the charger indoors.
- Do not disassemble or modify the charger.

About the Battery

(charging/number of recordable pictures)

■ Battery indication

The remaining battery power appears on the screen.



- The battery indication turns red and blinks. Recharge the battery or replace it with fully charged battery.

[It does not appear when you use the camera along with the AC adaptor (ACA-DC5; optional).]

■ The battery life

The number of recordable pictures (By CIPA standard in program AE mode)

Number of recordable pictures	Approx. 360 pictures (Approx. 180 min)
-------------------------------	---

Recording conditions by CIPA standard

- Temperature: 23 °C (73.4 °F)/
Humidity: 50% when LCD monitor is on.*
- Using the supplied SD Memory Card (512 MB).

- Using the supplied battery.
- Starting recording 30 seconds after the camera is turned on. (When the optical image stabilizer function is set to [MODE1])
- **Recording once every 30 seconds** with full flash every second recording.
- Turn the camera off every 10 recordings.
- CIPA is an abbreviation of [Camera & Imaging Products Association].
- *The number of recordable pictures decreases when the power LCD function is used.

The number of recordable pictures varies depending on the recording interval time.

If the recording interval time becomes longer, the number of recordable pictures decreases.

[e.g. When recording once every 2 minutes, the number of recordable pictures decreases by 90.]

The number of recordable pictures when using the viewfinder

(Recording conditions comply with CIPA standard.)

Number of recordable pictures	Approx. 360 pictures (Approx. 180 min)
--------------------------------------	---

Playback time when using the LCD monitor

Playback time	Approx. 300 min
----------------------	-----------------

The number of recordable pictures and playback time will vary depending on the operating conditions and storing condition of the battery.

■ Charging

Charging time	Approx. 120 min
----------------------	-----------------

- The [CHARGE] indicator lights when charging starts.

■ When the [CHARGE] indicator flashes

- The battery is over discharged (discharged excessively). In a while, the lamp will light and normal charging will start.
- When the battery temperature is excessively high or low, the charging time will be longer than normal.
- The terminals of the charger or the battery are dirty. In this case, wipe them with a dry cloth.
- When the operating time of the camera becomes extremely short even after properly charging the battery, the life of the battery may have expired. Buy a new battery.

■ Charging conditions

- Charge the battery in a temperature between 10 °C to 35 °C (50 °F to 95 °F). (The battery temperature should also be the same.)
- The performance of the battery may temporarily deteriorate and the operating time may become shorter in low temperature conditions (e.g. skiing/snowboarding).

Inserting/Removing the Battery

- Check that the camera is turned off.
- Close the flash.

1 Slide the release lever in the direction of arrow and open the battery door **(A)**.

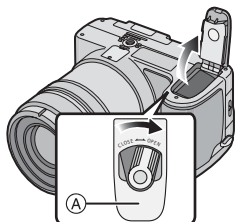

- Always use genuine Leica batteries (BP-DC5).

2 Insert:
Insert the charged battery until it clicks.

Remove:
Slide the lock **(B)** to remove the battery.

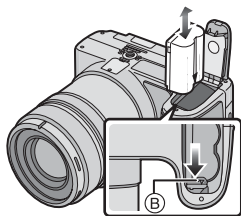

- 3** **1** Close the battery door.
2 Slide the release lever in the direction of the arrow.

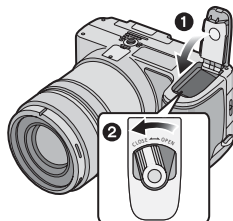

- Remove the battery after use.
- When a fully charged battery has been inserted for more than 24 hours, the clock setting is stored (in the camera) for at least 3 months even if the battery is removed. (If you insert a battery that is not sufficiently charged, the length of time that the clock setting is stored may become less.) However, the clock setting is canceled after this length of time. In this case, set the clock again. (P26)
- Do not remove the card or the battery while the card is being accessed. The data may be damaged. (P20)
- Do not remove the battery with the camera turned on since the settings on the camera may not be stored properly.
- The supplied battery is designed only for the camera. Do not use it with any other equipment.

Inserting/Removing the Card

- Check that the camera is turned off.
- Prepare an SD Memory Card (supplied), an SDHC Memory Card (optional) or a MultiMediaCard (optional).
- Close the flash.

1 Slide the card door to open it.

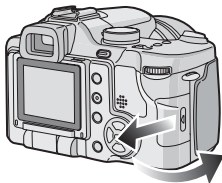

2 Insert:

Insert the card fully until it clicks and it is locked.

Remove:

Push the card until it clicks, then pull the card out upright.

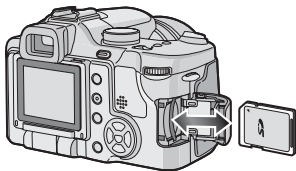

- Check the direction of the card.
- Do not touch the connection terminals on the back side of the card.
- The card may be damaged if it is not fully inserted.

- 1 Close the card door.
- 2 Slide the card door to the end and then close it firmly.

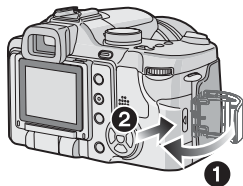

- If the card door cannot be completely closed, remove the card and insert it again.



- The card and the data may be damaged if it is inserted or removed while the camera is on.

About the Card

■ Access to the card

The card access indication (A) lights red when pictures are being recorded onto the card.

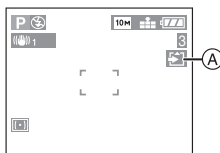

When the card access indication lights, pictures are being read or deleted or the card is being formatted. Do not:

- turn the camera off.
- remove the battery or the card.
- shake or impact the camera.

The card and the data may be damaged or the camera may not operate normally.

■ SD Memory Card (supplied), SDHC Memory Card (optional) and MultiMediaCard (optional)

- The SD Memory Card, SDHC Memory Card and MultiMediaCard are small, lightweight, removable external cards.
- The reading/writing speed of an SD Memory Card and an SDHC Memory Card is fast. Both types of card are equipped with a Write-Protect switch (B) that prevents writing and formatting the card. (If the switch is slid to the [LOCK] side, it is not possible to write or delete data on the card and format it. When the switch is slid to the other side, these functions become available.)

SD Memory Card



- Refer to P129 for information about the number of recordable pictures and the available recording time for each Card.
- This camera is compatible with SD Memory Cards based on SD Memory Card Specifications and formatted in FAT12 system and FAT16 system. It is also compatible with SDHC Memory Cards based on SD Memory Card Specifications and formatted in FAT32 system.
- The SDHC Memory Card is a memory card standard decided by the SD Association in 2006 for high capacity memory cards more than 2 GB.
- This camera is compatible with both an SD Memory Card and an SDHC Memory Card. You can use an SDHC Memory Card in equipment that is compatible with SDHC Memory Cards however you cannot use an SDHC Memory Card in equipment that is only compatible with SD Memory Cards. (If you use an SDHC Memory Card in other equipment, always read the operating instructions for the other equipment.)
- This unit does not support recording motion pictures on MultiMediaCards. We recommend using High Speed SD Memory Cards/SDHC Memory Cards when recording motion pictures. (P76)

■ About handling a card

Transfer important pictures/motion pictures from your card to your PC periodically (P112). The data on the card may be damaged or lost due to electromagnetic waves, static electricity, the camera breaking down or a defective card.

- Do not format the card on your PC or other equipment. Format it on the camera only to ensure proper operation. (P111)



- The reading/writing speed of a MultiMediaCard is slower than an SD Memory Card or SDHC Memory Card. When a MultiMediaCard is used, the performance of certain features may be slightly slower than advertised.
- Keep the Memory Card out of reach of children to prevent swallowing.

Attaching the Lens Cap/Strap

■ Lens Cap (supplied)

1 Attach the lens cap.

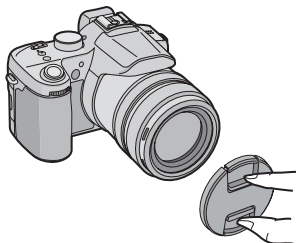

- When you turn the camera off, carry the camera or play back the pictures, attach the lens cap to protect the surface of the lens.
- Detach the lens cap before turning on the camera in the recording mode.
- Be careful not to lose the lens cap.

■ Strap (supplied)

1 Pass the strap through the hole at the strap eyelet.

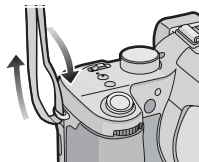

2 Pass the strap through the stopper and fasten the strap.

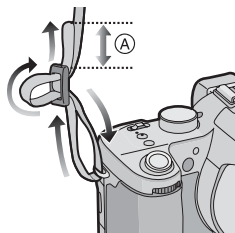

Ⓐ: Pull the strap 2 cm or more.

- Attach the strap to the other side of the camera being careful not to twist it.



- Check that the strap is firmly attached to the camera.
- Attach the strap so that the Leica Logo is on the outside.

Attaching the Lens Hood

In bright sunlight or backlight, the lens hood will minimize lens flare and ghosting. The lens hood cuts off excess lighting and improves the picture quality.

- Check that the camera is turned off.
- Close the flash.

1 Place the camera upside down, align the white mark (A) on the lens hood with lens hood positioning groove (B) on the unit and insert it straight in until it clicks.

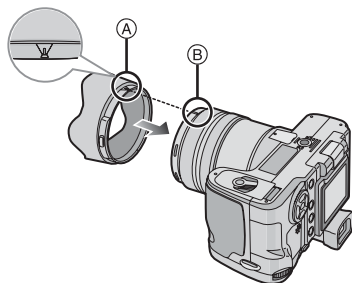

- Make sure the lens hood is properly attached.

■ When removing the lens hood Press lock release button (C) and remove the lens hood

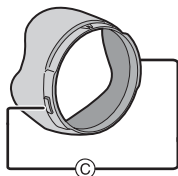

■ Temporarily storing the lens hood

1 Place the camera upside down, remove the lens hood and turn it around, aligning the white mark (A) on the lens hood with lens hood positioning groove (B) on the unit, and insert it straight in until it clicks.

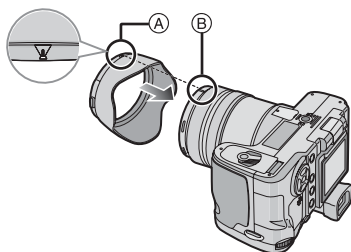

- Make sure the lens hood is properly attached.
- If you lightly turn the lens hood to the left and right of the lens hood positioning groove, it becomes easier to insert.

2 Attach the lens cap.

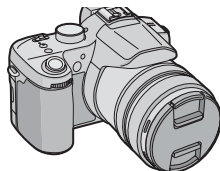

- Ensure that the lens cap is firmly attached.
- When temporarily storing the lens hood, ensure that it is firmly attached and that it is not reflected in the picture.
- When temporarily storing the lens hood, you can detach the lens cap and take pictures. However you cannot use the zoom ring, focus ring, [FOCUS] button or focus switch.

■ **When removing the lens hood**
Press lock release button **(C)** and
remove the lens hood

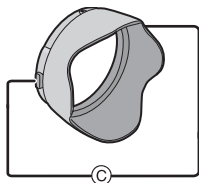

- If you press the lock release button too strongly, it may be difficult to detach the lens cap.



- Make sure that the mark on the lens hood is correctly aligned with the lens hood positioning groove. The lens hood is not correctly attached if they are not aligned.
- When taking pictures with flash with the lens hood attached, the lower portion of the photo may turn dark (vignetting effect) and the control of the flash may be disabled because the photo flash may be obscured by the lens hood. We recommend detaching the lens hood.
- When using the AF assist lamp in the dark, detach the lens hood.
- For details on how to attach filters, refer to P120.
- You cannot attach supplementary lenses when the lens hood is attached.

LCD Monitor

Adjusting the LCD monitor makes it possible to take pictures from various angles.

■ Taking pictures at a normal angle.

- You can switch between the LCD monitor and the viewfinder.

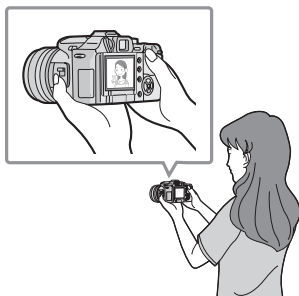

■ Taking pictures at a high angle Open the LCD monitor with one of the LCD monitor open knobs.

- You can use the LCD monitor only.

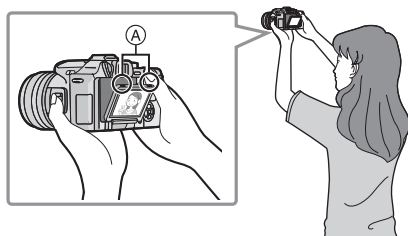

Ⓐ: LCD Monitor open knobs

- This is convenient when there is someone in front of you and you cannot get close to the subject.

■ Taking pictures at a low angle Take hold of the LCD monitor open knob with your fingers, and pull the knob toward you and rotate the monitor 180°.

- You can use the LCD monitor only.

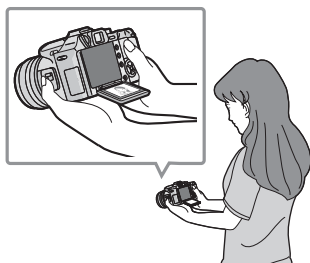

LCD monitor rotation direction

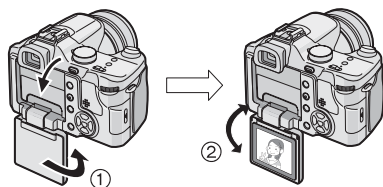

- ①: 180°
- ②: Maximum 180°

- This is convenient when taking pictures of flowers etc. that are in a low position.

■ Taking pictures with the camera held vertically

Take hold of the LCD monitor opening knob with your fingers, and pull the monitor all the way toward you (by rotating it 180°), and rotate it to an angle where it is easy to see. (It can be rotated up to a maximum of 270°.)

■ Taking pictures at a normal angle.

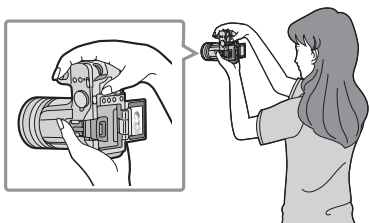

■ Taking pictures at a high angle

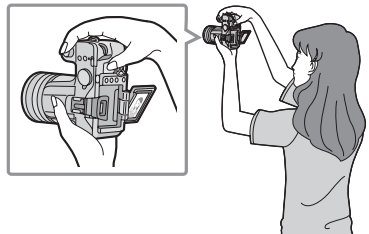

■ Taking pictures at a low angle

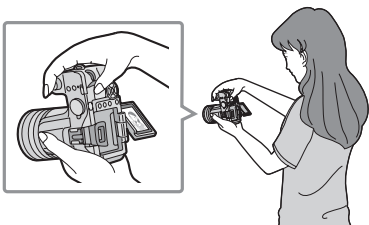

- If the LCD monitor turns on when it is closed with the screen facing inwards, the camera automatically switches to the viewfinder.
- If the LCD monitor is opened when the viewfinder is turned on, the camera automatically switches to the LCD monitor.
- **Only rotate the LCD monitor after opening it wide enough, and be careful not to use excessive force as it may be damaged.**
- When holding the edge of the LCD monitor, there may be some distortion, however this is not a malfunction. Moreover, this has no effect on the taken pictures or playback.
- When not using the LCD monitor it is recommended that you close it with the screen facing inwards to prevent dirt and scratches.

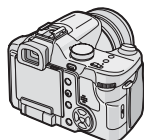

- **You may not be able to open, close or rotate the LCD monitor smoothly when using a tripod. In these cases, detach the camera from the tripod and then open, close or rotate the LCD monitor.**

■ About the viewfinder

The viewfinder is convenient when you want to take pictures of a moving subject or outdoors.

- Refer to page 44 for information about diopter adjustment.



- When using the viewfinder, close the LCD monitor.
- When the LCD monitor is open, the viewfinder cannot be used.

Setting Date/Time (Clock Set)

■ Initial setting

The clock is not set so the following screen appears when you turn the camera on.

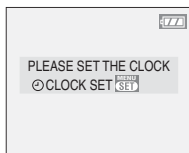
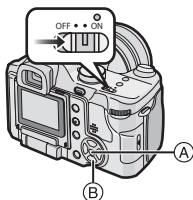

(A): [MENU/SET] button

(B): Cursor buttons

1 Press [MENU/SET].

2 Press ▲/▼/◀/▶ to select the date and time.

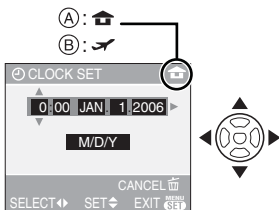

(A): Time at the home area

(B): Time at the travel destination (P73)

- ◀/▶: Select the desired item.

- ▲/▼: Set the display order for the date and time.

- Press [CANCEL] to cancel the clock setting without storing the date and time.

- Refer to [WORLD TIME] (P73) for information about setting the local time at the travel destination area.

3 Press [MENU/SET] several times to close the menu.

- Turn the camera off after finishing setting the clock. Then turn it on and check that the clock setting is correct.

■ Changing the clock setting

1 Press [MENU/SET].

2 Press ▲/▼ to select [CLOCK SET] (P101)

3 Press ▶ and then perform steps 2 and 3 to set the clock.

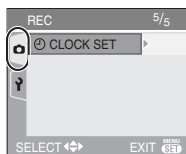

- You can also set the clock in the [SETUP] menu. (P27)



- When a fully charged battery has been inserted for more than 24 hours, the clock setting is stored (in the camera) for at least 3 months even if the battery is removed.

- You can set the year from 2000 to 2099. The 24-hour system is used.

- If the date is not set in the camera it will not be printed correctly when you use a photo printing service, even if the store provides a date printing option for your photographs. (P106)

About the Setup Menu

- Set items as required. (Refer to P28 to 31 for each menu item.)
- Menu items differ depending on the mode selected with the mode dial (P6).
The following example shows how to set [AUTO REVIEW] when program AE mode [P] is selected.
- Select [RESET] to return the settings to the initial settings at the time of purchase. (P30)

1 Press [MENU/SET] and then press ◀.

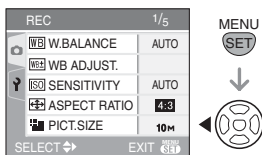

2 Press ▼ to select the [SETUP] menu icon [⌂] and then press ▶.

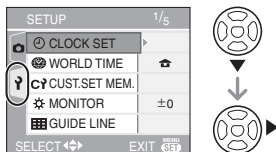

3 Press ▲/▼ to select the menu item.

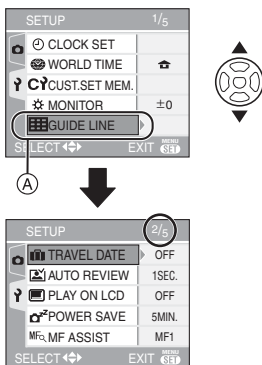

- Press ▼ at (A) to switch to the next menu screen.

(Press ▼ to select [AUTO REVIEW].)

4 Press ▶, press ▲/▼ to select the setting and then press [MENU/SET].

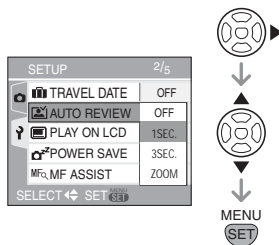

5 Press [MENU/SET] to close the menu.

- You can also press the shutter button halfway to close the menu.

■ About the menu screen items

- There are 5 menu screens (1/5, 2/5, 3/5, 4/5 and 5/5).
- You can switch menu screens from any menu item by rotating the front dial.

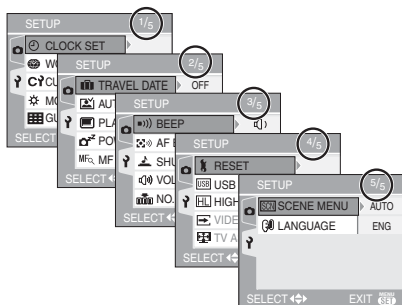



 **[CLOCK SET]**

Press  to display the [SETUP] menu and select this item. (P27)
Change date and time. (P26)

 **[WORLD TIME]**

Press  to display the [SETUP] menu and select this item. (P27)

: The time at your home area is set.

: The local time at the travel destination area is set.

• Refer to P73 for information about setting [WORLD TIME].

 **[CUST. SET MEM.]**

Press  to display the [SETUP] menu and select this item. (P27)

The current camera settings are registered in [C1], [C2] or [C3]. (P62)

 **[MONITOR/VIEWFINDER]**

Press  to display the [SETUP] menu and select this item. (P27)

Adjust the brightness of the LCD monitor (when pictures appear on the LCD monitor) or viewfinder (when pictures appear on the viewfinder) in 7 steps.

 **[GUIDE LINE]**

Press  to display the [SETUP] menu and select this item. (P27)

Set the pattern of the guide lines displayed when taking pictures. (P45)

You can also set whether or not to have the recording information and histogram displayed when the guide lines are displayed.

[REC. INFO.]: [ON]/[OFF]

[HISTGRAM]: [ON]/[OFF]

[PATTERN]: /[

 **[TRAVEL DATE]**

Press  to display the [SETUP] menu and select this item. (P27)

[SET]: When taking a picture, the date on which it was taken is recorded.

[OFF]: When taking a picture, the date on which it was taken it is not recorded.

• Refer to P71 for information about setting [TRAVEL DATE].

 **[AUTO REVIEW]**



Press  to display the [SETUP] menu and select this item. (P27)

[1SEC.]: The recorded picture automatically appears on the screen for about 1 second.

[3SEC.]: The recorded picture automatically appears on the screen for about 3 seconds.

[ZOOM]: The recorded picture automatically appears on the screen for about 1 second. It is then enlarged 4 times and appears for about 1 second. This mode is useful for confirming focus. Pictures recorded using auto bracket or continuous mode and pictures with audio are not enlarged even if [ZOOM] is selected.

[OFF]: The recorded picture does not automatically appear.

- The auto review function is not activated in motion picture mode [].
- When pictures are recorded in auto bracket (P53) or continuous mode (P55), the auto review function is activated regardless of the setting on the auto review function. (The picture is not enlarged.)
- The auto review function is activated while pictures with audio (P89) are being recorded regardless of its setting. (The picture is not enlarged.)
- If the auto review function is activated when [HIGHLIGHT] is set to [ON], any white saturated areas on the picture appear blinking in black. (P44)
- When the quality is set to [RAW], the auto review function works until the end of recording onto the card. (The picture is not enlarged.)
- The auto review setting is disabled when using auto bracket or continuous mode, in motion picture mode [] or when [AUDIO REC.] is set to [ON] or when the quality is set to [RAW].

[PLAY ON LCD]

Press [] to display the [SETUP] menu and select this item. (P27)

[ON]: If you were using the viewfinder to record, the display automatically switches to the LCD monitor when reviewing or playing back pictures. (P44)

[OFF]: Does not automatically switch.

[POWER SAVE]

Press [] to display the [SETUP] menu and select this item. (P27)

[1MIN.]/[2MIN.]/[5MIN.]/[10MIN.]:

Power save mode is activated (the camera is automatically turned off to save the battery life) if the camera has not been used for the time selected on the setting.

[OFF]: Power save mode is not activated.

- Press the shutter button halfway or turn the camera off and on to cancel power save mode.
- When using the AC adaptor (ACA-DC5; optional), connecting to a PC or a printer, recording or playing back motion pictures and during a slide show, power save mode is not activated. (However, the setting for power save mode is fixed to [10MIN.] while pausing a slide show or playing back a manual slide show.)

[MF ASSIST]

(Recording mode only)

Press [] to display the [SETUP] menu and select this item. (P27)

In manual focus, the assistance screen appears on the center of the screen to facilitate focusing on the subject. (P60)

[MF1]: The center of the image is enlarged. You can adjust the focus while determining the composition of the whole of the screen.

[MF2]: The whole image is enlarged. This is convenient for adjusting the focus in Wide angle shots.

[OFF]: The image is not enlarged.

[BEEP]

Press [] to display the [SETUP] menu and select this item. (P27)

[]: No operation sound

[]: Soft operation sound

[]: Loud operation sound

[AF BEEP]

Press [] to display the [SETUP] menu and select this item. (P27)

[]: No operation sound

[]: Soft operation sound

[]: Loud operation sound

[SHUTTER]

Press [] to display the [SETUP] menu and select this item. (P27)

Set to select the volume of shutter sound.

[]: No shutter sound

[]: Soft shutter sound

[]: Loud shutter sound

[VOLUME]

Press [] to display the [SETUP] menu and select this item. (P27)

The volume of speakers can be adjusted in 7 steps from level 6 to 0.

- When you connect the camera to a TV, the volume of the TV speakers does not change.

[NO.RESET]

Press [] to display the [SETUP] menu and select this item. (P27)

Set this when you want the file number of the next recording to start from 0001. (The folder number is reset and the file number starts from 0001.)

- A folder number between 100 and 999 can be assigned.

When the folder number reaches 999, the number cannot be reset. We recommend formatting the card after saving the data on a PC or elsewhere.

- To reset the folder number to 100, format (P111) the card first and then use this function to reset the file number. A reset screen for the folder number will then appear. Select [YES] to reset the folder number.
- Refer to P113 for detailed information about the file number and the folder number.

[RESET]

Press [] to display the [SETUP] menu and select this item. (P27)

The [REC], [CUST. SET MEM.] or [SETUP] menu settings are reset to the initial settings.

- The birthday setting for [BABY1]/[BABY2] (P69) in scene mode, the number of days that have passed since the departure date for [TRAVEL DATE] (P71) and the [WORLD TIME] setting (P73) are also reset when the [SETUP] menu settings are reset. Also, [FAVORITE] (P103) is fixed to [OFF] and [ROTATE DISP.] (P104) is fixed to [ON].
- The folder number and the clock setting are not changed.

[USB MODE]

Press [] to display the [SETUP] menu and select this item. (P27)

Select the USB communication system after or before connecting the camera to your PC or your printer with the USB connection cable (supplied).

SELECT ON CONNECTION:

Select either [PC] or [PictBridge (PTP)] if you connected the camera to a PC or a printer supporting PictBridge.

[PC]:

Set after or before connecting to a PC.

PictBridge (PTP):

Set after or before connecting to a printer supporting PictBridge.

- When [PC] is selected, the camera is connected via the “USB Mass Storage” communication system.

- When [PictBridge (PTP)] is selected, the camera is connected via the “PTP (Picture Transfer Protocol)” communication system.

[HIGHLIGHT]

Press [] to display the [SETUP] menu and select this item. (P27)

[ON]: When the auto review or review function is activated, a white saturated area appears flashing in black and white. (P44)

[OFF]: No highlight display

[VIDEO OUT]

(Playback mode only) (P118)

Press [] to display the [SETUP] menu and select this item. (P27)

[NTSC]: Video output is set to NTSC system.

[PAL]: Video output is set to PAL system.

[TV ASPECT]

(Playback mode only)

Press [] to display the [SETUP] menu and select this item. (P27)

[16:9]:

Select this if connecting the camera to a 16:9 TV.

[4:3]:

Select this if connecting the camera to a 4:3 screen TV.

- This is suitable for displaying pictures recorded with a [16:9] aspect on the full screen of a 16:9 TV. Pictures recorded with a [4:3] or [3:2] aspect are displayed with black bands on the left and right of the screen.
- When [4:3] is selected, pictures recorded with a [16:9] or [3:2] aspect are displayed with black bands on the top and bottom of the screen.
- When you select [16:9] and use the AV cable (supplied) for output (P118), pictures are displayed vertically on the LCD monitor.

SCN [SCENE MENU]

Press [] to display the [SETUP] menu and select this item. (P27)

[AUTO]: [SCENE MODE] menu appears automatically when setting the mode dial to scene mode. Select the desired scene mode. (P64)

[OFF]: [SCENE MODE] menu does not appear when setting the mode dial to scene mode and the camera is operated in scene mode currently selected. If you change the scene mode, press [MENU/SET] to display the [SCENE MODE] menu and then select the desired scene mode.

 [LANGUAGE]

Press [] to display the [SETUP] menu and select this item. (P27)

Set the language on the menu screen from the following languages. Set to the desired language with ▲/▼ and store it with [MENU/SET].

[ENGLISH] : English

[DEUTSCH] : German

[FRANÇAIS] : French

[ESPAÑOL] : Spanish

[ITALIANO] : Italian

[中文] : Chinese (Traditional)

[日本語] : Japanese

• If you set a different language by mistake, select [] from the menu icons to set the desired language.

Taking Pictures



The camera automatically sets the shutter speed and the aperture value according to the brightness of the subject.

- Remove the lens cap.

- 1 Turn the camera on.
- 2 Select program AE mode [P].

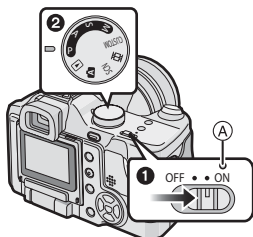

- The power indicator (A) (green) lights. When it flashes, the remaining battery power is low. Insert a fully charged battery.

- 2 Aim the AF area (1) to the point you want to focus on and then press the shutter button halfway.

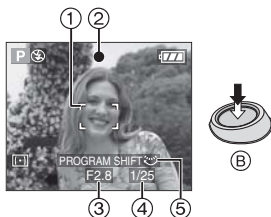

- (B): Press the shutter button halfway to focus.
- (5): Program shift
- The focus indication (2) lights up and then the aperture value (3) and the shutter speed (4) are displayed.

- When the ISO sensitivity is set to [ISO], the shutter speed will not be displayed. (P85)
- If [AF-ON] or [AF-ON] is used in AF mode, the AF area does not appear until the subject is brought into focus. (P90)
- The AF area displayed is larger than usual when using the digital zoom or when taking pictures in dark places. (P90)
- Refer to P33 for information about Program shift.

	When the subject is not focused	When the subject is focused
Focus indication	Flashes (green)	On (green)
AF area	Turns from white to red or no AF area	Turns from white to green
Sound	Beeps 4 times	Beeps 2 times

- 3 Take a picture.



- (C): Press the shutter button fully to take the picture.



- We recommend checking that the clock is set properly before taking pictures. (P26)
- When you press the shutter button, the screen may become bright or dark for a moment. This function allows easy adjustment of focus and the recorded picture will not be affected.
- When a time is set for power save (P29), the camera automatically turns off if you do not operate it within the set time. To operate the camera again, press the shutter button halfway or turn the camera off and on.

- To avoid picture noise, we recommend decreasing the ISO sensitivity, and/or setting [NOISE REDUCTION] in [PICT.ADJ.] to [HIGH] or setting every item except [NOISE REDUCTION] to [LOW]. (P94).

(ISO sensitivity is set to [100] when the camera is shipped. Therefore, when taking pictures indoors etc. the ISO sensitivity increases.)

■ Program shift

In program AE mode, you can change the preset aperture value and shutter speed without changing the exposure. This is called program shift.

You can make the background more blurred by decreasing the aperture value or record a moving subject more dynamically by slowing the shutter speed when taking a picture in program AE mode.

- If the direct exposure compensation function (P93) is activated, the way in which the dial is operated changes. The explanation shows the direct exposure compensation function deactivated as an example.
- Press the shutter button halfway and then rotate the rear dial to activate program shift while the aperture value and the shutter speed are displayed on the screen (for about 10 seconds).



- The program shift indication (D) appears on the screen when program shift is activated.
- Program shift is canceled if the camera is turned off or the rear dial is rotated left and right until the program shift indication disappears.

■ Example of program shift

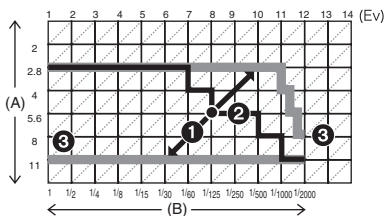

(A): Aperture value

(B): Shutter speed

① Program shift amount

② Program shift line chart

③ Program shift limit



- If the exposure is not adequate when the shutter button is pressed halfway, the aperture value and the shutter speed turns red.
- Program shift is canceled and the camera returns to normal program AE mode if more than 10 seconds pass after program shift is activated. However, the program shift setting is memorized.
- Depending on the brightness of the subject, program shift may not be activated.
- Program shift cannot be activated when the ISO sensitivity is set to [L] [ISO].

■ Tips for taking good pictures

- Hold the camera gently with both hands, keep your arms still at your side and stand with your feet slightly apart.
- When taking pictures, make sure your footing is stable and there is no danger of colliding with another person, a ball etc.

- Make sure the camera does not shake when you press the shutter button.
- Do not cover the microphone or the AF assist lamp with your fingers or other objects.
- Do not touch the front of the lens.
- If the LCD monitor image is difficult to see because of light from the sun etc. shining on it, we recommend using your hand or another object to shade the light when using the camera.

When recording with LCD Monitor

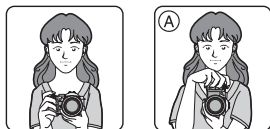

When recording with viewfinder



(A): When holding the camera vertically

■ Direction detection function

Pictures recorded with the camera held vertically are played back vertically (rotated). (Only when [ROTATE DISP.] (P104) is set to [ON])

- Pictures may not be displayed vertically if they were taken with the camera aimed up or down.
- Pictures cannot be displayed vertically when recording motion pictures or creating flip animations.

■ When you want to take a subject outside the AF area (AF/AE Lock)

When recording a picture of people with a composition like the following picture, you will not be able to focus the camera on the

subject because the people are outside the AF area.



In this case,

- 1 Aim the AF area at the subject.
- 2 Press the shutter button halfway to lock the focus and the exposure.
 - The focus indication lights when the subject is focused.
- 3 Press and hold the shutter button halfway while moving the camera as you compose the picture.
- 4 Press the shutter button fully.
 - You can repeatedly retry AF/AE lock before pressing the shutter button fully.

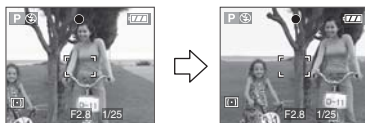

■ Focusing

- The focus range is 30 cm (0.98 feet) to ∞ (Wide), 2 m (6.56 feet) to ∞ (Tele). To take pictures of subjects nearby, use the AF Macro function. (P56)
 - If the distance between the camera and the subject is beyond the focus range of the camera, the picture may not be properly focused even if the focus indication lights up.
 - In the following cases, the camera will not focus on subjects properly.
 - When there are both near and distant subjects in a scene.
 - When there is dirt or dust on glass between the lens and the subject.
 - When there are illuminated or glittering objects around the subject.
 - When taking a picture in dark places.
 - When the subject is moving fast.
 - When the scene has low contrast.
 - When jitter occurs.
 - When recording a very bright subject.
- We recommend taking pictures using prefocus (P61) and [FOCUS/AE LOCK].

In dark places, the AF assist lamp (P91) may turn on to focus on the subject.

- Even when the focus indication appears and the subject is focused, it is canceled if you release the shutter button. Press the shutter button halfway again.
- Please do not rotate the zoom ring during auto focus.

■ Preventing jitter (camera shake)

- Be careful of jittering when pressing the shutter button.
- If jitter could occur because of slow shutter speed, the jitter alert (A) appears.

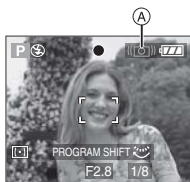

- When the jitter alert appears, we recommend using a tripod. Also, be careful how you hold the camera (P34). Using the self-timer (P51) or the remote control unit (CR-DC1; optional) (P120) prevents jittering caused by pressing the shutter button when you are using a tripod.
- Shutter speed will be slower particularly in the following cases. Keep the camera still from the moment the shutter button is pressed until the picture appears on the screen. We recommend using a tripod.
 - Slow sync./Red-eye reduction (P47)
 - [NIGHT PORTRAIT] (P66)
 - [NIGHT SCENERY] (P66)
 - [PARTY] (P67)
 - [CANDLE LIGHT] (P68)
 - [FIREWORKS] (P68)
 - [STARRY SKY] (P68)
 - When you set to a slow shutter speed (P57, 58)

■ Exposure

- If you press the shutter button halfway when the exposure is not adequate, the

aperture value and the shutter speed turn red. (They do not turn red when the flash is activated.)

- The brightness of the screen may differ from the brightness of the recorded pictures especially when recording in low light conditions.
- When most of the subjects on the screen are bright (e.g. a blue sky on a clear day, a snowy field etc.), the recorded pictures may become dark. In this case, compensate the exposure value on the camera. (P52)

■ Concerning the [FOCUS/AE LOCK] button

- In situations where the subject is outside the AF area or the subject contrast is too strong to compensate the exposure, for instance, this button makes it possible to take pictures using the focus and exposure that you locked ahead of time.

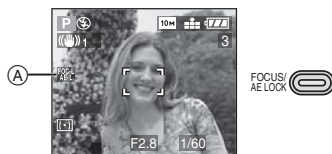

(A): FOCUS/AE lock indication

- If you press the shutter button halfway during FOCUS/AE LOCK, the [FOCUS/AE LOCK] indication flashes. You cannot lock the focus and the exposure when it is flashing. If you want to lock the focus and the exposure, press the [FOCUS/AE LOCK] button once more to cancel the lock and then lock them.
- Refer to P92 for information about [FOCUS/AE LOCK].

Taking Pictures in Auto Mode



This mode allows beginners to take pictures easily. The settings for those functions which are easy to make mistakes with are fixed at the time of purchase allowing pictures to be taken with fewer mistakes.

Select **[AF]** or **[AF MACRO]** with the focus switch.

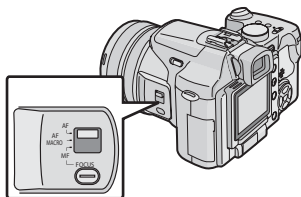

Auto Mode Settings

In auto mode the following items are fixed at the time of purchase to prevent mistakes being made when using the camera.

[W.BALANCE]	[AUTO]	P83
[SENSITIVITY]	[ISO]	P85
[AUDIO REC.]	[OFF]	P89
[METERING MODE]	[•]	P89
[AF MODE]	[■]	P90
[CONT.AF]	[OFF]	P91
[AF ASSIST LAMP]	[ON]	P91
[PICT.ADJ.]	[STD.]	P94
[FLIP ANIM.]	Cannot be set	P95
[EXT.FLASH]	Automatically switches between PRESET/TTL AUTO	P99

The Backlight Compensation

Backlight refers to when light comes from the back of a subject.

In this case, the subject, such as a person, will become dark.

If you press **▲**, the compensating backlight ON indication **[BL]** **(A)** appears and the backlight compensation function is activated. This function compensates the backlight by brightening the whole picture.

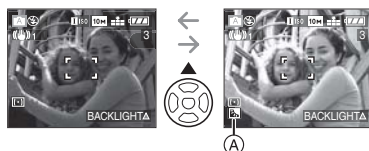

- If you press **▲** while **[BL]** is displayed, **[BL]** disappears and the backlight compensation function is canceled.
- We recommend using the flash when you use the backlight compensation function. (When using the flash, it is fixed to Forced ON **[⚡]**.)
- The flash setting is fixed to AUTO/Red-eye reduction **[⚡A]** when the backlight compensation function is set to **[OFF]**.



- Even if the focus switch is set to **[AF]**, you can take pictures approaching the subject at a distance of up to 5 cm (0.16 feet) from the lens by rotating the zoom ring upmost to Wide the same as if **[AF MACRO]** was selected.
- The settings for **[ASPECT RATIO]**, **[PICT.SIZE]**, **[QUALITY]** and **[CONVERSION]** in auto mode are applied to other recording modes.
- The AF Macro icon does not appear in auto mode **[A]**.
- You cannot use the following functions in auto mode.
 - **[WB ADJUST.]**
 - Exposure compensation
 - Auto bracket
 - Flash Output Adjustment
 - **[D.ZOOM]**
 - **[COL.EFFECT]**
 - **[FOCUS/AE LOCK]**

Taking Pictures with the Zoom

Using the Optical Zoom



You can make people and subjects appear closer with the 12× optical zoom and landscapes can be recorded in wide angle. (35 mm film camera equivalent: 35 mm to 420 mm)

■ To make subjects appear closer use Tele

Rotate the zoom ring (A) towards the right.

- When the setting for picture size is [10M] (10M).

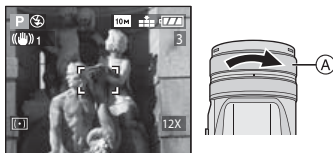

■ To make subjects appear further away use Wide

Rotate the zoom ring (A) towards the left.

- When the setting for picture size is [10M] (10M).

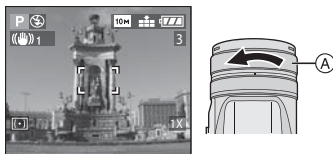

- Depending on the zoom magnification, the picture may have some distortion. Distortion will be more visible when using a wider area of the zoom lens as you move closer to the subject.

- If you use the zoom function after focusing on the subject, focus on the subject again.
- The indicated zoom magnification is an approximation.
- **When you rotate the zoom ring, you may hear some sound from the camera or the camera may be shaken. This is not a malfunction.**

Using the Extended Optical Zoom (EZ)



This camera has a 12× optical zoom.

However, if the picture size is not set to the highest setting for each aspect ratio [4:3 / 3:2 / 16:9], a maximum of 21.4× optical zoom can be achieved with no picture quality deterioration.



Picture size with the extended optical zoom not activated [example: [10M] (10M)]

Picture size with the extended optical zoom activated [example: [3M] (3M EZ)]



■ Extended optical zoom mechanism

When you set the picture size to [3M] (3M EZ) (3 million pixels), the 10M (10 million pixels) CCD area is cropped to the center 3M (3 million pixels) area, allowing a picture with a higher zoom effect.

Picture size and maximum zoom magnification

(○: Available, —: Not available)

Aspect ratio	Picture size	Maximum zoom magnification	Extended optical zoom
4:3	10M (10M)	12×	—
3:2	8.5M (8.5M)		
16:9	7M (7M)		
4:3	8M (8M EZ)	13.4×	—
3:2	7M (7M EZ)		
16:9	5.5M (5.5M EZ)		
4:3	5M (5M EZ)	17.1×	○
3:2	4.5M (4.5M EZ)		
4:3	3M (3M EZ)	21.4×	○
	2M (2M EZ)		
3:2	2.5M (2.5M EZ)		
16:9	2M (2M EZ)		



- Refer to P87 for aspect ratio settings and P87 for picture size.
- “EZ” is an abbreviation of “Extended optical Zoom”.
- You can further enhance the zoom magnification with the extended optical zoom without worrying about further picture distortion.
- If you set a picture size that activates the extended optical zoom, the extended optical zoom icon [] is displayed on the screen when you use the zoom function.
- The indicated zoom magnification is an approximation.
- The on-screen zoom indication may not change consecutively if you rotate the zoom ring near the Tele position when the extended optical zoom is used. This is not a malfunction.

- In motion picture mode [] and [HIGH SENS.] in scene mode, the extended optical zoom does not work.





Using the Digital Zoom Further extending the zoom



The digital zoom can be set to [2×] or [4×] with [D.ZOOM] in the [REC] menu and a maximum of 48× zoom can be achieved. However, if a picture size that can use the extended optical zoom (P87) is selected, a maximum of 85.5× zoom can be achieved with the 21.4× extended optical zoom and the 4× digital zoom.

Menu operation

1 Press [MENU/SET].

- When a scene mode is selected, press  in the [SCENE MODE] menu (P64), press  to select the [REC] menu icon [] and then press .

2 Press / to select [D.ZOOM] and then press .

3 Press to select [2×] or [4×] and then press [MENU/SET].

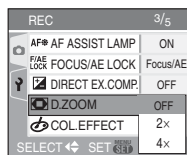

4 Press [MENU/SET] to close the menu.

- You can also press the shutter button halfway to close the menu.

■ Entering the digital zoom range

In the [REC] menu (P82), setting [D.ZOOM] to [2×] or [4×] allows you to magnify a subject up to a maximum of 48 times. (Except when using extended optical zoom.)

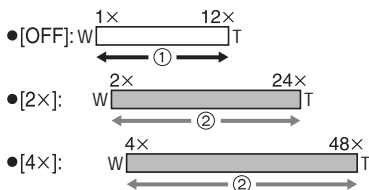

- ① Optical zoom
② Digital zoom

■ The digital zoom and extended optical zoom can be used together.

Example: When the digital zoom is set to [4×] and the picture size to [3M] (3M EZ), you can use the extended optical zoom at the same time.

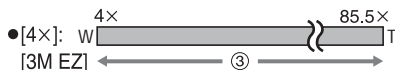

- ③ When using the digital zoom [4×] and the extended optical zoom [3M] (3M EZ (maximum 21.4 times)) together.



- When using the digital zoom, the AF area in the center of the screen is displayed and it is larger than usual. (P90)
- In digital zoom, the larger the picture the lower the picture quality.
- In the digital zoom range, the stabilizer function may not be effective.
- When using the digital zoom, we recommend using a tripod and the self-timer (P51) for taking pictures.
- The indicated zoom magnification is an approximation.
- The digital zoom is temporarily set to [OFF] in the following cases.
 - When taking pictures in auto mode [A] (P36)

– When the quality is set to [RAW] (P87)

– When [CONVERSION] on the [REC] menu is set to [] (P97)

- The digital zoom does not work in the following cases:

– In [SPORTS], [BABY1]/[BABY2] and [HIGH SENS.] in scene mode

– When the ISO sensitivity has been set to [ISO].

Checking the Recorded Picture (Review)



You can check the recorded pictures while still in [REC] mode.

1 Press ▼ [REV].

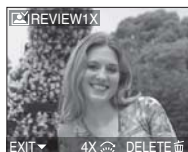

- The last recorded picture appears for about 10 seconds.
- Review is canceled when the shutter button is pressed halfway or the ▼ [REV] is pressed again.
- You can check other pictures by pressing ◀/▶.
- When the recorded pictures are too bright or too dim, compensate the exposure. (P52)

2 Rotate the front dial to the right to enlarge the picture.

- Rotate the front dial to the right for a 4× magnification and then rotate it even more for a 8× magnification. When you rotate the front dial towards the left after enlarging the picture, the magnification becomes lower.

3 Press ▲/▼/◀/▶ to move the position.

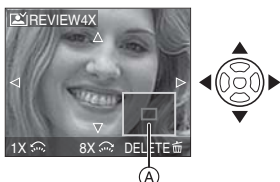

- When you change the magnification or the position to be displayed, the zoom position indication (A) appears for about 1 second so that you can check the enlarged area.

■ Deleting the recorded picture during Review (Quick deletion)

- 1 Press [🗑️].
- 2 Press ▲ to select [YES].
- 3 Press [MENU/SET].



- Once deleted, pictures cannot be recovered. Double-check pictures before deleting them.
- Multiple pictures or all the pictures can be deleted. For information about how to delete pictures, refer to P41.



- When [ROTATE DISP.] is set to [ON], pictures recorded holding the camera vertically are played back vertically (rotated). (P104)

Playing Back Pictures



Press ◀/▶ to select the picture.



- ◀/👤: Play back the previous picture
- ▶/👤: Play back the next picture
- The first recorded picture will be displayed after the last recorded picture.
- When [ROTATE DISP.] (P104) is set to [ON], pictures recorded by holding the camera vertically are played back vertically.

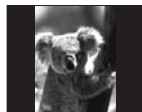

■ Fast forwarding/Fast rewinding

Press and hold ◀/▶ during playback

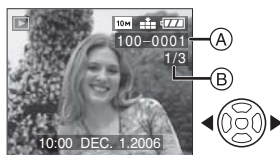

- ◀: Fast rewind
- ▶: Fast forward
- The file number (A) and the picture number (B) only change one by one. Release ◀/▶ when the number of the desired picture appears to play back the picture.
- If you press and hold ◀/▶, the number of files forwarded/rewound at one time increases. The actual number of files forwarded/rewound at one time depends on the number of files recorded.

- In review playback in recording mode and in multi playback (P78), the pictures can only be forwarded or rewound one by one.



- This camera is based on the DCF standard "Design rule for Camera File system".
- The file format that can be played back on the camera is JPEG. (In some cases, even JPEG pictures cannot be played back.)
- The LCD monitor may not be able to display the details of the recorded pictures. You can use the playback zoom (P80) to check the details of the pictures.
- If you play back pictures that have been recorded with other equipment, the picture quality may deteriorate. (The pictures are displayed as [THUMBNAIL IS DISPLAYED] on the screen.)
- If you change a folder name or file name on your PC, the pictures may not play back on the camera.
- If you play back a non-standard file, the folder/file number is indicated by [—] and the screen may turn black.
- Depending on the subject, an interference fringe may appear on the screen. This is called moire. This is not a malfunction.

Deleting Pictures



■ To delete a single picture

1 Select the picture with ◀/▶.



- ◀/☺: Play back the previous picture
- ▶/☺: Play back the next picture

2 Press [].

3 Press ▲ to select [YES] and then press [MENU/SET].



- While the picture is being deleted, [] appears on the screen.

■ To delete [MULTI DELETE]/[ALL DELETE]

1 Press [] twice.

2 Press ▲/▼ to select [MULTI DELETE] or [ALL DELETE] and then press [MENU/SET].

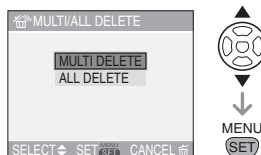

- If you select [MULTI DELETE], perform steps **3** onwards.
- If you select [ALL DELETE], perform steps **5** onwards.
- When [FAVORITE] (P103) is set to [ON], [ALL DELETE EXCEPT ★] appears. If you select [ALL DELETE EXCEPT ★], perform steps **5** onwards. (However, if none of the pictures have [★] displayed, you cannot select [ALL DELETE EXCEPT ★] even if [FAVORITE] is set to [ON].)

3 Press ◀▶ to select the picture and then press ▼ to set.

(Only when selecting [MULTI DELETE])

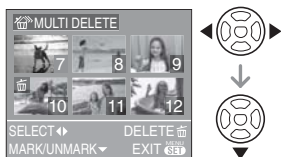

- Repeat the above procedure.
- [] appears on the selected pictures. If ▼ is pressed again, the setting is canceled.
- The icon [] flashes red if the selected picture is protected and cannot be deleted. Cancel the protect setting and then delete the picture. (P107)

4 Press [].

5 Press ▲ to select [YES] and then press [MENU/SET] to set.

(Screen when selecting [MULTI DELETE])



- [DELETE ALL IMAGES IN THE MEMORY CARD?] is displayed when

using [ALL DELETE] and [DELETE ALL EXCEPT ★ ?] is displayed when using [ALL DELETE EXCEPT ★].

- If you press [MENU/SET] while deleting pictures using [ALL DELETE] or [ALL DELETE EXCEPT ★], the deleting will stop halfway.



• **Once deleted, pictures cannot be recovered. Double-check pictures before deleting them.**

- Do not turn off the camera while deleting.
- When deleting pictures, use a battery with sufficient battery power (P16) or the AC adaptor (ACA-DC5; optional).
- It is possible to delete up to 50 pictures at one time using [MULTI DELETE].
- The greater the number of pictures the longer it takes to delete them.
- If there are pictures that are protected [] (P107), do not conform to the DCF standard (P41) or are in a card with the Write-Protect switch slid to the [LOCK] side (P20), they are not deleted even if [ALL DELETE] or [ALL DELETE EXCEPT ★] is selected.

About the LCD Monitor/Viewfinder

Changing the information displayed

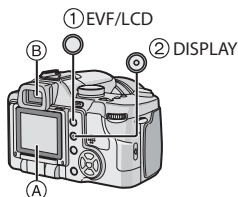

① Switching the LCD monitor/viewfinder

Press the [EVF/LCD] button to switch the monitor screen.

- Ⓐ LCD monitor (LCD)
- Ⓑ Viewfinder (EVF)

• When the LCD monitor turns on, the viewfinder turns off (and vice versa).

② Selecting the screen to be used

Press the [DISPLAY] button to change the display.

• When the menu screen appears, the [DISPLAY] button is not activated. In playback zoom (P80), while playing back motion pictures (P81) and during a slide show (P102), you can only select “Normal display Ⓒ” or “No display Ⓔ”.

In recording mode

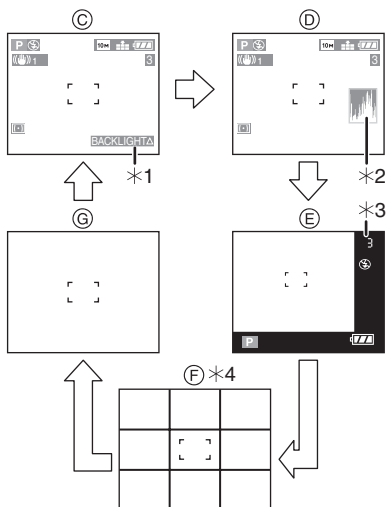

- Ⓒ Normal display
 - Ⓓ Display with histogram
 - Ⓔ Out-of-frame display
 - Ⓕ Recording guide line
 - Ⓖ No display
- *1 Displayed only in auto mode
- *2 Histogram
- *3 When the number of pictures remaining is more than 1000 or the time remaining in motion picture mode is more than 1000 seconds, [+999] is displayed.
- *4 The display information will differ depending on what has been set using the [GUIDE LINE] (P28) on the [SETUP] menu. (P45)

In playback mode

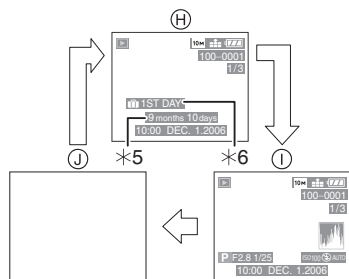

(H) Normal display

(I) Display with recording information and histogram

(J) No display

*5 Displayed if [BIRTHDAY SET.] and [WITH AGE] were set in [BABY1]/[BABY2] (P69) in scene mode before taking pictures.

*6 The number of days that have passed since the travel date are displayed if [TRAVEL DATE] (P71) is set.



• In [NIGHT PORTRAIT] (P66), [NIGHT SCENERY] (P66), [FIREWORKS] (P68) and [STARRY SKY] (P68) in scene mode, the guide lines is grey.

■ Out-of-frame display

You can therefore concentrate on the subject when taking pictures without being obstructed by information displayed on the screen.

■ Diopter adjustment

Adjust the diopter to suit your vision so that you can see the viewfinder image clearly.

• Close the LCD monitor and press the [EVF/LCD] button to switch on the viewfinder.

Look at the display on the viewfinder and rotate the diopter adjustment dial so that the image is clearest.

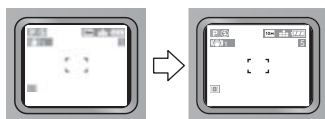
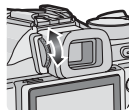

■ Monitor priority

When [PLAY ON LCD] is set to [ON] on the [SETUP] menu (P29), the LCD monitor is turned on in the following cases.

You can save the time it would take to switch the display to the LCD monitor even when using the viewfinder to record.

- When switching from recording mode to playback mode.
- When reviewing pictures. (P39)
- When turning the camera on in playback mode.

■ Highlight feature

If [HIGHLIGHT] is set to [ON] in the [SETUP] menu (P30) and then the auto review or review function is activated after recording, you can check for any white saturated areas (extremely bright or glistening parts) on the picture. White saturated areas appear flashing in black.

- If you want to prevent white saturation, refer to the histogram and compensate the exposure towards minus before taking a picture.

Highlight feature OFF

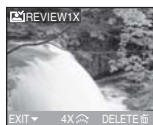

Highlight feature ON



- There may be white saturated areas if the distance to the subject is too close when taking pictures with the flash. White saturated areas appear flashing in black.



■ Brighten the LCD monitor for use outdoors. (Power LCD)

Press and hold the [DISPLAY] button for more than 1 second to activate the power LCD function. The LCD monitor becomes brighter than normal and it becomes easier to use outdoors.



Ⓐ: Power LCD indication

- While taking a picture, the LCD monitor automatically returns to the normal brightness if nothing is pressed for 30 seconds. Press any button to make the LCD monitor bright again.
- If you press and hold the [DISPLAY] button for 1 second again, the power LCD function is deactivated and the LCD monitor returns to the normal brightness.
- The brightness and the colors of the pictures displayed on the LCD monitor are adjusted when the power LCD function is activated. Therefore, some subjects may look different on the LCD monitor. However this does not affect the actual recording.

■ Recording Guide Lines



When you align the subject on the horizontal and vertical guide lines or the cross point of these lines, you can take pictures with well-designed composition by viewing the size, the slope and the balance of the subject.

Ⓐ

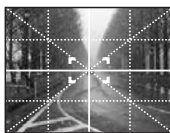

Ⓑ



- Ⓐ : This is used when dividing the entire screen into 3×3 for taking pictures with a well-balanced composition.
- Ⓑ : This is used when you want to position the subject at the exact center of the screen.

■ Histogram

- A histogram is a graph that displays brightness along the horizontal axis (black to white) and the number of pixels at each brightness level on the vertical axis.
- It allows you to easily check a picture's exposure.
- It is very useful if manual adjustments of the lens aperture and shutter speed are available, especially in those situations where automatic exposure may be difficult due to uneven lighting. Using the histogram feature allows you to get the maximum performance from your camera.
 - When the values are concentrated on the left, the picture is under exposed.
 - When the values are distributed evenly, the exposure is proper and the brightness is well-balanced.
 - When the values are concentrated on the right, the picture is over exposed.

Example of histogram

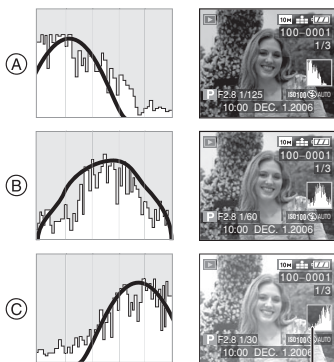

- (A) Under Exposed
 (B) Properly Exposed
 (C) Over Exposed
 *Histogram



- **When the recorded picture and the histogram do not match each other under the following conditions, the histogram is displayed in orange.**
 - When the manual exposure assistance is other than [$\pm 0EV$] during exposure compensation or in the manual exposure mode
 - When the flash is activated
 - In [FIREWORKS] (P68) or [STARRY SKY] (P68) in scene mode
 - When the flash is closed
 - When the brightness of the screen is not correctly displayed in dark places
 - When the exposure is not adequately adjusted
- The histogram is an approximation in recording mode.
- The histogram of a picture may not match in recording mode and playback mode.
- The histogram displayed in this camera does not match histograms displayed by picture editing software used in PCs etc.
- Check for any white saturated areas with the highlight display when the auto review or review function is activated. (P44)
- The histogram does not appear in motion picture mode [] and during multi playback, playback zoom and calendar playback.

Taking Pictures using the Built-in Flash

P A S M C SCN A

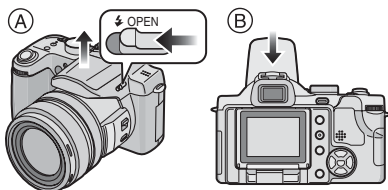

A To open the flash

Slide the [⚡ OPEN] lever.

B To close the flash

Press the flash until it clicks.

- Be sure to close the flash when not in use.
- The flash setting is fixed to Forced OFF [☹] while the flash is closed.

Switching to the appropriate flash setting

Set the flash to match the recording.

1 Press ► [⚡].

2 Press ▲/▼ to select a mode.

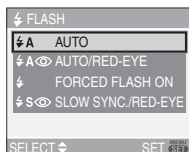

- You can also press ► [⚡] to select.
- For information about flash settings that can be selected, refer to “Available flash settings by recording mode”. (P48)

3 Press [MENU/SET].

- You can also press the shutter button halfway to finish.
- The menu screen disappears after about 5 seconds. At this time, the selected item is automatically set.

⚡A : AUTO

The flash is automatically fired when the recording conditions make it necessary.

⚡A with eye icon : AUTO/Red-eye reduction*1

The flash is automatically fired when the recording conditions make it necessary. It is fired once before the actual recording to reduce the red-eye phenomenon (eyes of the subject appearing red in the picture) and then fired again for the actual recording.

- Use this when you take pictures of people in low lighting conditions.

⚡ : Forced ON

The flash is fired every time regardless of the recording conditions.

- Use this when your subject is back-lit or under fluorescent light.

⚡A with eye icon : Forced ON/Red-eye reduction*1

- The flash setting is set to Forced ON/Red-eye reduction only when you set [PARTY] (P67) or [CANDLE LIGHT] (P68) in scene mode.

⚡S with eye icon : Slow sync./Red-eye reduction*1

If you take a picture with a dark background landscape, this feature will slow the shutter speed when the flash is fired so that the dark background landscape will become bright. Simultaneously it reduces the red-eye phenomenon.

- Use this when you take pictures of people in front of a dark background.

☹ : Forced OFF

The flash is not fired in any recording conditions.

- Use this when you take pictures in places where the use of the flash is not permitted.

*1 The flash is fired twice. The subject should not move until the second flash is fired.

■ Available flash settings by recording mode

The available flash settings depend on the recording mode.

(○: Available, —: Not available)

P	○	○	○	○	—	○
A	○	○	○	○	—	○
S	○	○	○	—	—	○
M	○	○	○	—	—	○
A	—	○*2	—*2	—	—	○
	—	—	—	—	—	○
	○	○	○	—	—	○
	○	○	○	—	—	○
	—	—	—	—	—	○
	○	○	○	—	—	○
	—	—	—	—	—	○
	—	—	—	○	○	○
	○	○	○	—	—	○
	○	—	○	—	—	○
	—	—	—	○	○	○
	—	—	—	—	—	○
	—	—	—	—	—	○
	○	○	○	—	—	○
	○	○	○	—	—	○
	○	—	○	—	—	○
	—	—	—	—	—	○

• The flash setting may change if the recording mode is changed. Set the flash setting again if necessary.

*2 It becomes Forced ON [], when the backlight compensation function is activated.

■ The available flash range to take pictures

The available flash range to take pictures depends on the ISO sensitivity selected.

ISO sensitivity	Available flash range
[AUTO]	Wide
	30 cm (0.98 feet) to 7.4 m (24.28 feet)
	Tele
[ISO]	Wide
	30 cm (0.98 feet) to 7.4 m (24.28 feet)
	Tele
[ISO100]	Wide
	30 cm (0.98 feet) to 3.7 m (12.14 feet)
	Tele
[ISO200]	Wide
	40 cm (1.31 feet) to 5.2 m (17.06 feet)
	Tele
[ISO400]	Wide
	60 cm (1.97 feet) to 7.4 m (24.28 feet)
	Tele
	60 cm (1.97 feet) to 5.6 m (18.37 feet)

[ISO800]	Wide
	80 cm (2.62 feet) to 7.4 m (24.28 feet)
	Tele
[ISO1600]	Wide
	1.15 m (3.77 feet) to 7.4 m (24.28 feet)
	Tele
[ISO1600]	90 cm (2.95 feet) to 5.6 m (18.37 feet)

- The available flash range is an approximation.
- Refer to P85 for the ISO sensitivity.
- Refer to P34 for the focus range.
- If ISO sensitivity is set to [AUTO] or [ISO] when using the flash, it will be automatically increased to a maximum of [ISO400].
- To avoid picture noise, we recommend reducing the ISO sensitivity, setting [NOISE REDUCTION] in [PICT.ADJ.] to [HIGH] or setting the items except [NOISE REDUCTION] to [LOW] to take pictures. (P94)
- In motion picture mode [M] and [SCENERY] (P65), [NIGHT SCENERY] (P66), [FIREWORKS] (P68), [STARRY SKY] (P68) or [HIGH SENS.] (P70) in scene mode, the flash setting is fixed to Forced OFF [OFF] even if the flash is opened.

■ Shutter speed for each flash setting

Flash setting	Shutter speed (Sec.)
A : AUTO	1/30 to 1/2000
A : AUTO/Red-eye reduction	1/30 to 1/2000
ON : Forced ON/Red-eye reduction	1/30 to 1/2000
ON : Forced ON/Red-eye reduction	1 to 1/2000
S : Slow sync./Red-eye reduction	1 to 1/2000
OFF : Forced OFF	1 to 1/2000 (In program AE mode)

- Refer to P59 for the Aperture-priority AE, Shutter-priority AE or Manual exposure mode.
- There may be differences in the above shutter speeds in scene mode.
 - [NIGHT SCENERY] (P66): 8 seconds to 1/2000th of a second
 - [FIREWORKS] (P68): 1/4th of a second, 2 seconds
 - [STARRY SKY] (P68): 15 seconds, 30 seconds, 60 seconds

■ Adjusting flash output

Adjust the flash output when the subject is small or reflection ratio is extremely high or low.

- 1 Press **▲** () several times until [FLASH] appears and then press **◀/▶** to set the flash output.



- Select [0] to return to the original flash output.

2 Press [MENU/SET] to finish.

- You can adjust from [-2 EV] to [+2 EV] in steps of [1/3 EV].
- When the flash output is adjusted, the flash output value appears on the upper left of the screen.
- The flash output setting is memorized even if the camera is turned off.
- The flash output cannot be adjusted in the following cases:
 - In the auto mode [A]
 - In the motion picture mode [M]
 - In [SCENERY], [NIGHT SCENERY], [FIREWORKS], [STARRY SKY] or [HIGH SENS.] in scene mode
- When [DIREC. EX. COMP.] (P93) in the [REC] mode menu is set to [ON], the flash output can be adjusted directly using the front dial or rear dial.



- **Do not look directly at the flash at close range when it is activated.**
- **Do not bring the flash too close to objects or close the flash while it is activated. The objects may be discolored by its heat or light.**
- **Do not cover the flash reflector with your fingers or other objects.**
- If you press the shutter button halfway when the flash is activated, the flash icon turns red.
- When the jitter alert appears, we recommend using a tripod.
- When you take a picture beyond the available flash range, the exposure may not be adjusted properly and the picture may become bright or dark.
- When taking a picture with the flash, the white balance is automatically adjusted (except for [☼], [☼^{WB}]). However, the white balance may not be properly adjusted if the flash level is insufficient. (P83)

- When the shutter speed is fast, the flash effect may not be sufficient.
- If you repeat taking a picture, it may not actually be taken even if the flash is activated. Take a picture after the access indication disappears.
- When the flash is being charged, the flash icon flashes red, and you cannot take a picture even when you press the shutter button fully.
- **When taking a picture with the flash, we recommend removing the lens hood. In some cases it may not allow the scene to be illuminated properly.**
- Do not close the flash soon after the flash is fired prior to taking pictures due to AUTO/Red-eye reduction etc. It causes a malfunction.
- The red-eye reduction effect differs between people. Also, if the subject was far away from the camera or was not looking at the first flash, the effect may not be evident.
- When using a conversion lens (optional) or a close up lens (optional), the built-in flash setting is fixed to Forced OFF [☼].
- When you set continuous mode or auto bracket, only 1 picture is recorded for every flash activated.
- When you attach an external flash, it takes priority over the built-in flash. Refer to P99 for the external flash.
- When a dedicated flash (optional) is used, the flash output can be adjusted and the flash settings by picture-taking mode can be used.

Taking Pictures with the Self-timer



1 Press ◀ [ⓘ].

2 Press ▲/▼ to select a mode.

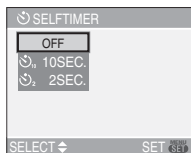

- You can also press ◀ [ⓘ] to select.

3 Press [MENU/SET].

- You can also press the shutter button halfway to finish.
- The menu screen disappears after about 5 seconds. At this time, the selected item is automatically set.

4 Press the shutter button halfway to focus and then press it fully to take the picture.

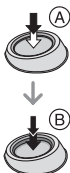

- (A): Press the shutter button halfway to focus.
- (B): Press the shutter button fully to take the picture.
- The self-timer indicator © flashes and the shutter is activated after 10 seconds (or 2 seconds).

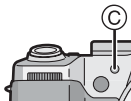

- If you press [MENU/SET] while the self-timer is set, the self-timer setting is canceled.



- When using a tripod etc., setting the self-timer to 2 seconds is a convenient way to avoid the jitter caused by pressing the shutter button.
- When you press the shutter button once fully, the subject is automatically focused just before recording. In dark places, the self-timer indicator will flash and then may turn on brightly operating as an AF assist lamp (P91) to allow the camera to focus on the subject.
- When you set the self-timer in continuous mode, the camera starts taking a picture 2 or 10 seconds after the shutter button is pressed. The number of pictures taken at one time is fixed to 3.
- We recommend using a tripod when recording with the self-timer. (When you use a tripod, make sure the tripod is stable when the camera is attached to it.)

Compensating the Exposure



Use this function when you cannot achieve appropriate exposure due to the difference in brightness between the subject and the background. Look at the following examples.

Under exposed



Compensate the exposure towards positive.



Properly exposed



Over exposed



Compensate the exposure towards negative.

1 Press **▲** [**+**] until [EXPOSURE] appears, compensate the exposure with **◀/▶**.



- You can compensate from [-2 EV] to [+2 EV] in steps of [1/3 EV].
- Select [0 EV] to return to the original exposure.

2 Press [MENU/SET] to finish.

- You can also press the shutter button halfway to finish.



- EV is an abbreviation of "Exposure Value". It refers to the amount of light given to the CCD by the aperture value and the shutter speed.
- The exposure compensation value appears on the lower left of the screen.
- The set exposure value is memorized even if the camera is turned off.
- The compensation range of the exposure will be limited depending on the brightness of the subject.
- Exposure cannot be compensated when using [STARRY SKY] in scene mode.
- When [DIREC. EX. COMP.] (P93) in the [REC] mode menu is set to [ON], the exposure can be compensated directly using the front dial or rear dial.

Taking Pictures using Auto Bracket



In this mode, 3 pictures are automatically recorded in the selected exposure compensation range each time the shutter button is pressed. You can select the picture with the desired exposure from the 3 pictures with different exposures.

1 Press **▲** [**+**] several times until [AUTO BRACKET] appears, set the compensation range of the exposure with **◀/▶**.

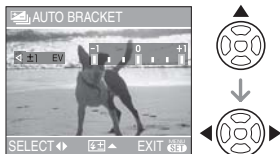

- You can select [0] (OFF), [$\pm 1/3$ EV], [$\pm 2/3$ EV] or [± 1 EV].
- When you do not use auto bracket, select [0] (OFF).

2 Press [MENU/SET] to finish.

- You can also press the shutter button halfway to finish.



- When setting auto bracket, the auto bracket icon [] appears on the lower left of the screen.
- When taking pictures using auto bracket after setting the exposure compensation range, the pictures taken are based on the selected exposure compensation range. When the exposure is compensated, the exposure compensation value appears on the lower left of the screen.

- When setting auto bracket and continuous mode simultaneously, auto bracket will be performed.
- When auto bracket is set, the auto review function is activated regardless of the auto review setting. (The picture is not enlarged.) You cannot set the auto review function in the [SETUP] menu.
- When auto bracket is activated, [AUDIO REC.] cannot be used.
- The exposure may not be compensated with auto bracket depending on the brightness of the subject.
- When setting the quality to [RAW], you cannot take pictures with the auto bracket.
- In shutter-priority AE and manual exposure, if the shutter speed is set to more than 1 second auto bracket is disabled.
- When the flash is activated or the number of recordable pictures is 2 or less, you can take only 1 picture.
- You cannot set auto bracket in [SPORTS], [STARRY SKY] and [BABY1]/[BABY2] in scene mode and in auto mode [**A**].
- When the ISO sensitivity is set to [**1** ISO], auto bracket cannot be used.
- When [DIREC. EX. COMP.] (P93) in the [REC] mode menu is set to [ON], the compensation range of the exposure can be set directly using the front dial or rear dial.

Optical Image Stabilizer



This mode detects jitter and compensates for it.

- 1 Press and hold the optical image stabilizer button (A) until [STABILIZER] appears.



- 2 Press ▲/▼ to select the stabilizer function mode and then press [MENU/SET].

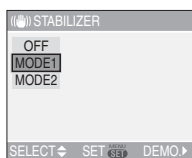

[MODE1] ()	The stabilizer operates continuously to facilitate easier composition.
[MODE2] ()	The jitter is compensated only when the shutter button is pressed. The stabilizing effect is greater.
[OFF] ()	When you want to take a picture without stabilization.

■ Demonstration of the optical image stabilizer (Demonstration Mode)

Press ► to display the demonstration. After the demonstration ends, the screen returns to the stabilizer function mode selection menu. Press ► again if you want to exit the demonstration before it ends.

While the demonstration is displayed, you cannot take pictures.

While the demonstration is displayed, set the optical zoom to Wide (1×).



- The stabilizer function may not be effective in the following cases.
 - When there is a lot of jitter.
 - When the zoom magnification is high.
 - In digital zoom range.
 - When taking pictures while following a moving subject.
 - When the shutter speed becomes slower to take pictures indoors or in dark places.
- Be careful of camera jitter when you press the shutter button.
- The setting is fixed to [OFF] in [STARRY SKY] (P68) in scene mode. The stabilizer function mode selection menu does not appear.
- In motion picture mode [] or [PANNING] in scene mode, [MODE2] cannot be set.

Taking Pictures using Continuous Mode



1 Press and hold the continuous mode button.



2 Press ▲/▼ to select a mode.

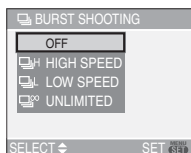

- You can also press the continuous mode button to select.

3 Press [MENU/SET].

- You can also press the shutter button halfway to finish.
- The menu screen disappears after about 5 seconds. At this time, the selected item is automatically set.

4 Take a picture.

- Hold down the shutter button fully to start the continuous mode.

■ Number of pictures recorded in continuous mode

	Frequency (pictures/second)	Number of recordable pictures (pictures)	
	2*	max. 3	max. 5
	1*		
	approx. 1	Depends on the remaining capacity of the card.	

- * The frequency is constant regardless of the transfer speed of the card.
- The number of pictures indicated is when the shutter speed is faster than 1/60 and the flash is not activated.
- The frequency (pictures/second) may become slower in dark places etc. depending on the recording environment.



• When the continuous mode setting is set to Unlimited

- You can take pictures until the capacity of the card is full.
- The frequency will become slower halfway. The frequency of a MultiMediaCard becomes even slower than that of an SD Memory Card or SDHC Memory Card. However, the exact timing of this depends on the number of recordable pictures and the card.
- The focus is fixed when the first picture is taken.
- When the self-timer is used, the number of recordable pictures in continuous mode is fixed to 3.
- Continuous mode is not canceled when the camera is switched off.
- When auto bracket and continuous mode are set simultaneously, auto bracket will be performed.
- The exposure and the white balance vary depending on the continuous mode setting. When continuous mode is set to , they are fixed to the values set for the first picture. When the frequency is set to or , they are adjusted each time you take a picture.
- When continuous mode is set, the auto review function is activated regardless of the auto review setting. (The picture is not enlarged.) You cannot set the auto review function in the [SETUP] menu.
- When continuous mode is activated, [AUDIO REC.] cannot be used.
- When the flash is activated, you can take only 1 picture.
- You cannot take pictures in continuous mode when the quality is set to [RAW] or [STARRY SKY] in scene mode is selected.

Taking Close-up Pictures



This mode allows you to take close-up pictures of the subject, e.g. When taking pictures of flowers.

You can take pictures approaching the subject at a distance up to 5 cm (0.16 feet) from the lens by rotating the zoom ring upmost to Wide (1×).

1 Set the focus switch to [AF MACRO].

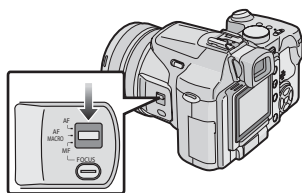

■ Focus range

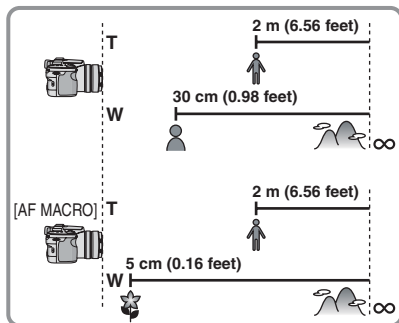

- We recommend using a tripod and the self-timer (P51) with AF macro.
- When a subject is close to the camera, the effective focus range (depth of field) is significantly narrowed. Therefore, if the

distance between the camera and the subject is changed after focusing on the subject, it may become difficult to focus on it again.

- If the distance between the camera and the subject is beyond the focus range of the camera, the picture may not be properly focused even if the focus indication lights.
- AF Macro gives priority to a subject close to the camera. Therefore, if the distance between the camera and the subject is more than 1 m (3.3 feet) it takes longer to focus on it with [AF MACRO] than [AF].
- The available flash range is about 30 cm (0.98 feet) to 7.4 m (24.28 feet) (Wide). (When the ISO sensitivity is set to [AUTO].)
- We recommend setting the flash to Forced OFF [] when you take pictures at close range.
- When you take pictures at close range, the resolution of the periphery of the picture may decrease slightly. This is not a malfunction.
- The AF Macro icon does not appear in auto mode []. (P36)

Aperture-priority AE



Set the aperture value to a higher number when you want a sharp focus background. Set the aperture value to a lower number when you want a soft focus background.

1 Rotate the front dial to the left or right to set the aperture value.



2 Take a picture.



- If the direct exposure compensation function (P93) is activated, the way in which the dial is operated changes. The explanation here shows the direct exposure compensation function deactivated as an example.
- Refer to P59 for the available aperture values and the shutter speed.
- Set the aperture value to a higher number when the subject is too bright. Set the aperture value to a lower number when the subject is too dim.
- The brightness of the screen and the recorded pictures may differ. Check the pictures using the review function or playback mode.
- The ISO sensitivity cannot be set to [AUTO] or [ISO]. (P85) (The ISO

sensitivity is automatically set to [ISO100] when you switch from [AUTO] to Aperture-priority AE or Shutter-priority AE.)

- The aperture value and the shutter speed displayed on the screen turn red when the exposure is not adequate.

Shutter-priority AE



When you want to take a sharp picture of a fast moving subject, set with a faster shutter speed. When you want to create a trail effect, set to a slower shutter speed.

1 Rotate the rear dial to the left or right to set the shutter speed.



2 Take a picture.



- If the direct exposure compensation function (P93) is activated, the way in which the dial is operated changes. The explanation here shows the direct exposure compensation function deactivated as an example.
- Refer to P59 for the available aperture values and the shutter speed.
- The brightness of the screen may differ from the brightness of the actual pictures. Check the pictures using the review function or playback mode.
- You cannot set the following items in Shutter-priority AE.

- Slow sync./Red-eye reduction [⚡👁️] (P47)
- [AUTO] or [ISO] in ISO sensitivity (P85) (The ISO sensitivity is automatically set to [ISO100] when you switch from [AUTO] to Aperture-priority AE or Shutter-priority AE.)
- The aperture value and the shutter speed turn red when the exposure is not adequate.
- We recommend using a tripod when the shutter speed is slow.

Manual exposure



Determine the exposure by manually setting the aperture value and the shutter speed.

1 Rotate the front or rear dial to the left or right to set the aperture value or the shutter speed.



	Set the aperture value.
	Set the shutter speed.

2 Press the shutter button halfway.



- The manual exposure assistance (A) appears for about 10 seconds to indicate the exposure.

- Set the aperture value and the shutter speed again when the exposure is not adequate.

3 Take a picture.



Manual Exposure Assistance

	The exposure is adequate.
	Set to faster shutter speed or larger aperture value.
	Set to slower shutter speed or smaller aperture value.

- The manual exposure assistance is an approximation. We recommend checking the pictures after taking them using the review function.



- Refer to P59 for the available aperture values and the shutter speed.
- You cannot set the following items in manual exposure.
 - Slow sync./Red-eye reduction [⚡👁️] (P47)
 - [AUTO] or [ISO] in ISO sensitivity (P85) (The ISO sensitivity is automatically set to [ISO100] when you switch from [AUTO] or [ISO] to Manual exposure.)
 - Exposure compensation (P52)
- The brightness of the screen may differ from the brightness of the actual pictures. Check the pictures using the review function or playback mode.
- If the exposure is not adequate, the aperture value and the shutter speed turn red when the shutter button is pressed halfway.

Aperture Value and Shutter Speed

Aperture-priority AE

Available Aperture Value (Per 1/3 EV)			Shutter Speed (Sec)
F8.0 to F11.0			8 to 1/2000
F7.1	F6.3	F5.6	8 to 1/1600
F5.0	F4.5	F4.0	8 to 1/1300
F3.6	F3.2	F2.8	8 to 1/1000

Shutter-priority AE

Available Shutter Speed (Sec) (Per 1/3 EV)		Aperture Value
8	6	F2.8 to F11.0
5	4	
3.2	2.5	
2	1.6	
1.3	1	
1/1.3	1/1.6	
1/2	1/2.5	
1/3.2	1/4	
1/5	1/6	
1/8	1/10	
1/13	1/15	
1/20	1/25	
1/30	1/40	
1/50	1/60	
1/80	1/100	
1/125	1/160	
1/200	1/250	
1/320	1/400	
1/500	1/640	
1/800	1/1000	
1/1300		F4.0 to F11.0
1/1600		F5.6 to F11.0
1/2000		F8.0 to F11.0

Manual exposure

Available Aperture Value (Per 1/3 EV)	Available Shutter Speed (Sec) (Per 1/3 EV)
F2.8 to F3.6	60 to 1/1000
F4.0 to F5.0	60 to 1/1300
F5.6 to F7.1	60 to 1/1600
F8.0 to F11.0	60 to 1/2000



- The aperture values given in the table above are values when the zoom ring is rotated to Wide.
- Depending on the zoom magnification, some of the shutter speeds and aperture values cannot be selected.

Taking Pictures with Manual Focus



Use this function when you want to fix the focus or when the distance between the lens and the subject is determined and you do not want to activate auto focus.

1 Slide the focus switch to [MF].

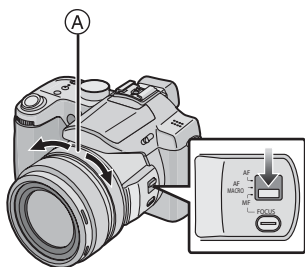

2 Rotate the focus ring (A) to focus on the subject.

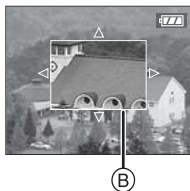

(B): MF assistance

- The MF assistance appears on the center of the screen.
- When you stop rotating the focus ring, the MF assistance disappears about 2 seconds after.
- You can also set [MF ASSIST] to [OFF] on the [SETUP] menu.

3 Take a picture.

■ MF ASSIST

When you rotate the focus ring while setting [MF ASSIST] to [MF1] or [MF2], the MF assistance is activated and the image is enlarged. It allows you to focus on the subject more easily.

1 Press [MENU/SET] and then press ◀.

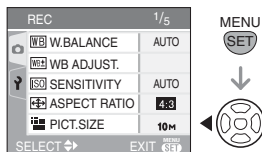

2 Press ▼ to select the [SETUP] menu icon [Y] and then press ▶.

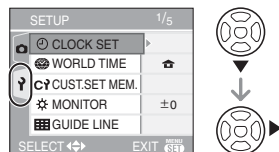

3 Press ▲/▼ to select [MF ASSIST] and then press ▶.

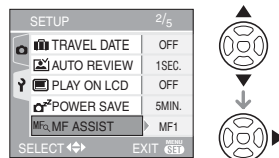

4 Press ▲/▼ to select [MF1] or [MF2] and then press [MENU/SET].

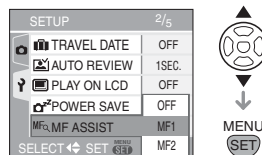

- [MF1]: The center of the image is enlarged. You can adjust the focus while determining the composition of the whole of the screen.
- [MF2]: The whole image is enlarged. This is convenient when adjusting the focus in Wide.
- [OFF]: The image is not enlarged.

5 Press [MENU/SET] to close the menu.

- You can also close the menu by pressing the shutter button halfway.

■ Technique for Manual focus

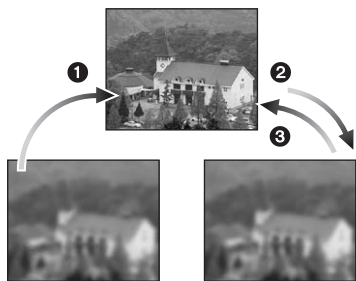

- 1 Rotate the focus ring slowly.
- 2 Rotate it little more.
- 3 Finely focus on the subject with rotating the focus ring reversely.

■ One shot AF

You can focus on the subject with auto focus by selecting [MF] with the focus switch and then press the [FOCUS] button. This is convenient for prefocus.

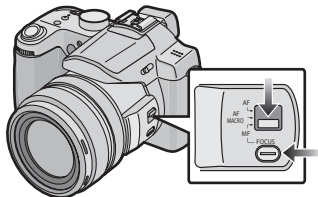

■ Prefocus

This is a technique for focusing in advance on the point the pictures will be taken when it is difficult to focus on the subject with auto focus due to its quick motion. [e.g. [PANNING] (P66) in scene mode] This function is suitable when the distance between the camera and the subject is certain.

■ Focus lock

You can fix the focus if you press [FOCUS/AE LOCK] after focusing at the position where you want to record the subject. This is useful since the subject will not go out of focus even if you rotate the focus ring.

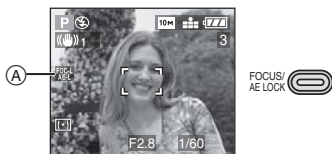

(A): FOCUS/AE lock indication

■ Changing the zoom area

The magnified area can be changed while the image is expanded using MF Assist. This is convenient when you want to change the focus position to take pictures.

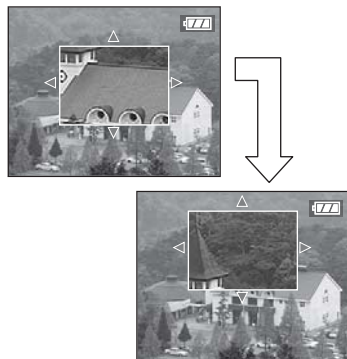

1 Rotate the Focus ring.

- 2 Press ▲/▼/◀/▶ to change the expanded area.
- The expansion is canceled after approximately 2 seconds.
- The following will return the AF area to the original position.
- Changing the Focus switch to [AF] or [AF MACRO].
 - Changing the picture size or aspect.
 - Turning the camera off.



- You can also record with manual focus in motion picture mode [M]. However the image is not expanded while recording motion pictures.
- If you focus on the subject in Wide and then rotate the zoom ring to Tele, the focus may not be adequate. In this case, focus on the subject again.
- You cannot set continuous AF (P91) when manual focus is set.
- If you rotate the focus ring or zoom ring while recording motion pictures, recording pictures with audio or adding audio to recorded pictures, a grinding noise may be recorded.
- Use the assistance screen for a final check of the focus.
- After canceling power save mode, focus on the subject again.

Registering Personal Menu Settings (Registering custom settings)



Select the desired recording mode and the desired menu settings and then save them in [C1], [C2] or [C3].

- Set to the mode dial to the desired mode and select the desired menu settings in advance.

1 Press [MENU/SET] and then press ◀.

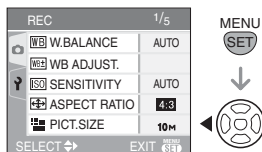

2 Press ▼ to select the [SETUP] menu icon [Y] and then press ▶.

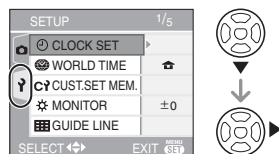

3 Press ▲/▼ to select [CUST. SET MEM.] and then press ▶.

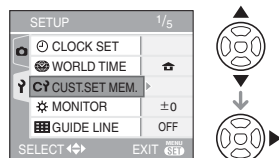

4 Press ▲/▼ to select [C1], [C2] or [C3] and then press [MENU/SET].

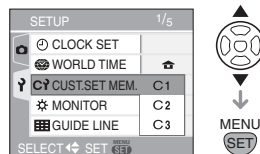

5 Press ▲ to select [YES] and then press [MENU/SET].

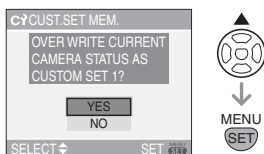

- When [YES] is selected, the settings that were previously stored are overwritten.
- You cannot save the following menu items because they affect all the recording modes.
 - [CLOCK SET]
 - [RESET]
 - [NO.RESET].

6 Press [MENU/SET] to close the menu.

Taking pictures in Custom mode



You can select one of your own custom settings to suit the picture-taking conditions and other factors from among the registered patterns you have saved as custom settings ahead of time.

1 Press ▲/▼ to select [C1 SET1], [C2 SET2] or [C3 SET3].

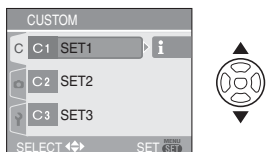

- Press ► to display the settings for each menu item. (Press ◀ to return to the selection screen.)

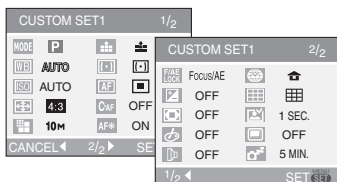

- Only the main menu items are displayed.

2 Press [MENU/SET] to enter the settings.

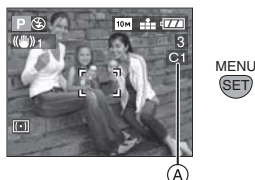

- Ⓐ: Saving of the selected custom settings is displayed on the screen.

■ When changing the menu settings

Even if the menu settings are changed temporarily with [C1 SET1], [C2 SET2] or [C3 SET3] selected, what has been registered will remain unchanged. To change what has been registered, overwrite the registered data using [CUST. SET MEM.] (P62) on the setup menu.



- Even if the birthday setting for [BABY1]/[BABY2] (P69) in scene mode, or the [TRAVEL DATE] (P71) is changed, it will not be registered. To register the setting that has been changed, use [CUST. SET MEM.] on the setup menu to register the new setting.
- At the time of purchase, the initial settings for the program AE mode [P] are registered in [C1 SET1], [C2 SET2] or [C3 SET3].

Scene Mode



When you select a scene mode to match the subject and recording situation, the camera sets the optimal exposure and hue to obtain the desired picture.

- Refer to P65 to 70 for each scene menu.

1 Press ▲/▼ to select the scene mode.

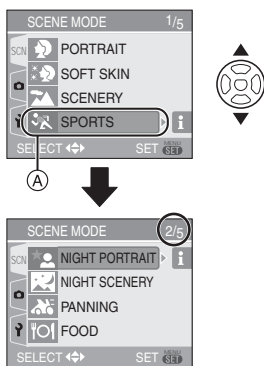

- Press ▼ at (A) to switch to the next menu screen.
- If [SCENE MODE] menu does not appear, press [MENU/SET] to display the [SCENE MODE] menu.
- When you press ►, explanations about each scene mode are displayed. (When you press ◀, the screen returns to the [SCENE MODE] menu.)

2 Press [MENU/SET].

■ About the menu screen items

- There are 5 menu screens (1/5, 2/5, 3/5, 4/5 and 5/5).

- You can switch menu screens from any menu item by rotating the front dial.

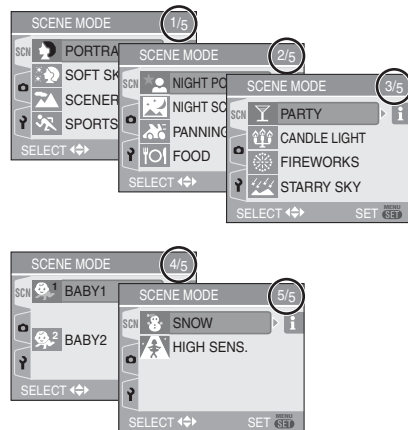

- When you take a picture with a scene mode that is not adequate for the purpose, the hue of the picture may differ from the actual scene.
- When you want to change the brightness of the picture to be recorded, compensate the exposure (P52). (However, the exposure cannot be compensated in [STARRY SKY].)
- Press ◀ and then press ▲/▼ in the [SCENE MODE] menu to select either the [REC] menu icon [📷] (P82) or the [SETUP] menu icon [⚙] (P27) and set the desired items.
- The following cannot be set in scene mode because the camera automatically adjusts them to the optimal setting.
 - [W.BALANCE]
 - [SENSITIVITY]
 - [METERING MODE]
 - [COL.EFFECT]
 - [PICT.ADJ.]

[PORTRAIT]

Press [MENU] to display the [SCENE MODE] menu and select a scene mode. (P64)
The background is blurred and the person stands out with a healthier complexion.



■ Technique for Portrait mode

To increase the effectivity of this mode:

- 1 Rotate the zoom ring as far as possible to the right
- 2 Move close to the subject to make this mode more effective.



- This mode is only suitable when taking pictures outdoors in the daytime.

[SOFT SKIN]

Press [MENU] to display the [SCENE MODE] menu and select a scene mode. (P64)
The camera detects the face or skin area to achieve a smoother appearance of the skin than portrait mode.



■ Technique for Soft skin mode

To make this mode more effective:

- 1 Rotate the zoom ring as far as possible to the right
- 2 Move close to the subject to make this mode more effective.



- This mode is only suitable when taking pictures outdoors in the daytime.
- If a part of the background etc. is a color close to skin color, this part is also smoothed.

- This mode may not be effective when there is insufficient brightness.

[SCENERY]

Press [MENU] to display the [SCENE MODE] menu and select a scene mode. (P64)
The camera focuses preferentially on a distant subject. This allows you to take pictures of a wide landscape.
• Set the focus switch to [AF].



- The focus range is 5 m (16.4 feet) to ∞ .
- The flash setting is fixed to Forced OFF [OFF].
- The setting on the AF assist lamp is disabled.

[SPORTS]

Press [MENU] to display the [SCENE MODE] menu and select a scene mode. (P64)
Select this mode when you want to take pictures of sports scenes or other events with quick motion.
• Set the focus switch to [AF].



- This mode is suitable for taking pictures of subjects 5 m (16.4 feet) or more from the camera.
- When taking pictures indoors of a fast-moving subject, the [ISO] function automatically increases the ISO sensitivity to avoid blurring.
- The ISO sensitivity is fixed to [ISO].
- The auto bracket setting is disabled.

[NIGHT PORTRAIT]

Press  to display the [SCENE MODE] menu and select a scene mode. (P64)
This mode allows you to take pictures of a subject and a landscape with near real-life brightness by using the flash and slowing down the shutter speed.



■ Technique for Night portrait mode

- **Use the flash.**
- Since the shutter speed becomes slower, we recommend using a tripod and the self-timer (P51) for taking pictures.
- Keep the subject still for about 1 second after taking the picture.
- We recommend taking pictures with zoom set to Wide (1×) and a distance of about 1.5 m (4.92 feet) from the subject.



- The focus range is 1.2 m (3.94 feet) to 5 m (16.4 feet). (Refer to P48 for the available flash range to take pictures.)
- Be sure to close the flash when not in use.
- The shutter may remain closed (max. about 1 sec.) after taking the picture because of signal processing. This is not a malfunction.
- Noise may become visible when you take pictures in dark places.
- When using the flash, Slow sync./Red-eye reduction  is selected and the flash is activated every time.
- The continuous AF setting is disabled.

[NIGHT SCENERY]

Press  to display the [SCENE MODE] menu and select a scene mode. (P64)
This mode allows you to record the nightscape vividly by reducing the shutter speed.

- Set the focus switch to [AF].

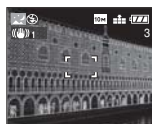

■ Technique for Night scenery mode

- Since the shutter speed becomes slower (up to about 8 sec.) use a tripod. We also recommend using the self-timer (P51) for taking pictures.



- The focus range is 5 m (16.4 feet) to ∞.
- The shutter may remain closed (max. about 8 sec.) after taking the picture because of signal processing. This is not a malfunction.
- Noise may become visible when you take pictures in dark places.
- The flash setting is fixed to Forced OFF .
- The setting on the AF assist lamp and continuous AF are disabled.

[PANNING]

Press  to display the [SCENE MODE] menu and select a scene mode. (P64)
When you move the camera to follow a subject moving in one direction such as a runner or car, the background becomes a blur and the subject stays focused. This effect is called “panning”. This mode allows you to obtain this effect easier.



■ Technique for Panning mode

To obtain good pictures in panning mode, move the camera in a horizontal plane as you take the pictures.

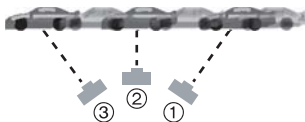

- ① Move the camera smoothly while following the subject in the viewfinder.
- ② Press the shutter button while you are moving the camera.
- ③ Move the camera continuously.

• We recommend the following:

- Use the viewfinder. (P43)
- Select a subject with quick motion.
- Use prefocus. (P61)
- Use this mode with continuous mode. (P55) (You can then select the best pictures from all the pictures taken.)



- The shutter speed in panning mode becomes slower to achieve the panning effect. As a result, jitter can easily occur.
- The panning function does not work well in the following situations.
 - During very bright days in summer. We recommend using a neutral density filter.
 - When the shutter speed is faster than 1/100th of a second.
 - When you move the camera too slowly because the subject is moving slowly. (The background will not become a blur.)
 - When the camera does not keep up with the subject satisfactorily
- You cannot set the stabilizer function mode to [MODE2]. When you set it to [MODE1], only vertical jitters can be compensated in panning mode.
- The settings on the AF assist lamp and the continuous AF are disabled.

[FOOD]

Press [MENU] to display the [SCENE MODE] menu and select a scene mode. (P64)
This mode allows you to take pictures of food with a natural hue without being affected by the ambient light in restaurants etc.



- The focus range is 5 cm (0.16 feet) (Wide)/2 m (6.56 feet) (Tele) to ∞.

[PARTY]

Press [MENU] to display the [SCENE MODE] menu and select a scene mode. (P64)
Select this mode when you want to take pictures at a wedding reception, indoor party etc. By using the flash and slowing down the shutter speed, both people and the background can be recorded with a brightness close to real life.



■ Technique for Party mode

- **Open the flash. (P47)**
- Since the shutter speed becomes slower, we recommend using a tripod and the self-timer (P51) for taking pictures.
- We recommend taking pictures with zoom set to Wide (1×) and a distance of about 1.5 m (4.92 feet) from the subject.



- The flash setting can be set to Slow sync./ Red-eye reduction [⚡S👁] or Forced ON/ Red-eye reduction [⚡👁].

[CANDLE LIGHT]



Press [] to display the [SCENE MODE] menu and select a scene mode. (P64)
This mode allows you to take pictures with a candle-lit atmosphere.



■ Technique for Candle light mode

- If you make the most of the candle light, you can take successful pictures without using the flash.
- We recommend using a tripod and the self-timer (P51) for taking pictures.



- The focus range is 5 cm (0.16 feet) (Wide)/2 m (6.56 feet) (Tele) to ∞ .
- The flash setting can be set to Slow sync./ Red-eye reduction [] or Forced ON/ Red-eye reduction [].

[FIREWORKS]

Press [] to display the [SCENE MODE] menu and select a scene mode. (P64)
This mode allows you to take beautiful pictures of fireworks exploding in the night sky.



■ Technique for Fireworks mode

We recommend performing the following steps to prefocus on the point the pictures will be taken so that you do not miss taking pictures of the fireworks when they are fired.

- 1 Set the focus switch to [MF] (P60)

- 2 Aim the camera at an object, such as a distant light, that is about the same distance from the camera as the point where the fireworks will rise.
 - 3 Press the [FOCUS] button until the focus indication (P32) lights.
 - 4 Aim the camera in the direction that the fireworks will be fired and wait.
 - 5 Press the shutter button fully to take the picture when the fireworks are fired.
- If zoom was used, the focus position will not be correct. Perform steps 2 to 5 again.
 - We recommend using a tripod.



- The focus range is 5 m (16.4 feet) to ∞ in AF mode. (We recommend performing steps 1 to 5 above for prefocus.)
- The shutter speed becomes the following.
 - When [OFF] is set on the optical image stabilizer function: Fixed to 2 seconds
 - When [MODE1] or [MODE2] is set on the optical image stabilizer function: 1/4th of a second or 2 seconds (The shutter speed becomes 2 seconds only when the camera has determined that there is little jitter such as when using a tripod etc.)
- Histograms are always displayed in orange. (P46)
- The flash setting is fixed to Forced OFF [].
- The setting on the AF assist lamp and continuous AF are disabled.

[STARRY SKY]

Press [] to display the [SCENE MODE] menu and select a scene mode. (P64)
This mode allows you to take vivid pictures of a starry sky or a dark subject that you

could not take in [NIGHT SCENERY] by making the shutter speed slower.



■ Setting the shutter speed

- Select a shutter speed of [15 SEC.], [30 SEC.] or [60 SEC.].
- 1 Press ▲/▼ to select the number of seconds and then press [MENU/SET].

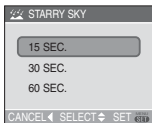

2 Taking Pictures.



- Press the shutter button to display the countdown screen. Do not move the camera after this screen is displayed. When countdown finishes, [PLEASE WAIT...] is displayed for the same length of time as the set shutter speed for signal processing.
- Press [MENU/SET] to stop taking the picture while the countdown screen is displayed.

■ Technique for Starry sky mode

- The shutter opens for 15, 30 or 60 seconds. Be sure to use a tripod. We also recommend taking pictures with the self-timer. (P51)
- We recommend using prefocus (P61) to focus in advance on a subject, such as a bright star or a distant light, that is easy to focus on.



- Histograms are always displayed in orange. (P46)
- The continuous AF setting is disabled.
- The flash setting is fixed to Forced OFF [OFF].
- The optical image stabilizer function is fixed to [OFF].
- You cannot compensate the exposure or set [AUDIO REC.], auto bracket, continuous mode, continuous AF.



[BABY1/



[BABY2]

Press [MENU/SET] to display the [SCENE MODE] menu and select a scene mode. (P64)
This mode takes pictures of a baby with a healthy complexion. When the flash is used, the light from it is weaker than usual. You can set the birthdays of two babies by using [BABY1] and [BABY2].

- The baby's age can be displayed when playing back pictures.

■ Age display setting

- If you want the age to be displayed, set the birthday in advance, select [WITH AGE] and press [MENU/SET].
- If you do not want the age to be displayed, select [WITHOUT AGE] and press [MENU/SET].



■ Birthday setting

- 1 Press ▲/▼ to select [BIRTHDAY SET.] and then press [MENU/SET].
- 2 When the message [PLEASE SET THE BIRTHDAY OF THE BABY] appears, select items (Year/Month/Day) using ◀/▶ and set them using ▲/▼.
- 3 Press [MENU/SET] to finish the setting.
 - If you select [WITH AGE] without setting the birthday in advance, a message is displayed. Press [MENU/SET] and set the birthday in steps 2 and 3.



- The focus range is 5 cm (0.16 feet) (Wide)/2 m (6.56 feet) (Tele) to ∞.
- The ISO sensitivity is fixed to [1] ISO].
- The auto bracket setting is disabled.
- After turning on the camera in [BABY1]/[BABY2] in scene mode or switching to [BABY1]/[BABY2] from other scene modes, the age and current date and time are displayed for about 5 seconds at the bottom of the screen.
- The age display style differs depending on the language setting in the recording mode.
- The display style when printing may differ slightly from the display style on the screen.
- The date of birth is displayed as [0 month 0 day].
- If the age is not properly displayed, check the clock and birthday settings.
- If the camera is set to [WITHOUT AGE], the age is not recorded even if the time and birthday are set. This means the age cannot be displayed even if camera is set to [WITH AGE] after taking the pictures.
- Use [RESET] in the [SETUP] menu to reset the birthday setting. (P30)

👤 [SNOW]

Press [MENU] to display the [SCENE MODE] menu and select a scene mode. (P64)
This mode will adjust the white balance and the exposure to show the snow as white as possible.



👤 [HIGH SENS.]

Press [MENU] to display the [SCENE MODE] menu and select a scene mode. (P64)
Select this mode for high-sensitivity processing. You can take pictures at ISO 3200 sensitivity.



- The resolution of the recorded picture decreases slightly because of high sensitivity processing. This is not a malfunction.
- The focus range is 5 cm (0.16 feet) (Wide)/2 m (6.56 feet) (Tele) to ∞.
- You can take pictures suitable for 4"×6"/10×15 cm printing.
- The flash setting is fixed to Forced OFF [🚫].
- The quality cannot be set to [RAW].
- The extended optical zoom and digital zoom cannot be used.

Recording which day of the vacation you take the picture



If you set the departure date in advance, you can record which day of the vacation you take the picture.

- When you play back a picture, the date on which it was taken is displayed.

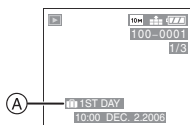

- (A): The number of days that have passed since the departure date

- **Setting the travel date**
(The following screens are shown when program AE mode [P] is selected.)

- 1 Press [MENU/SET] and then press ◀.**

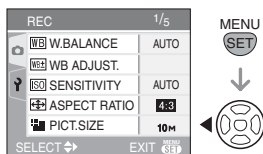

- 2 Press ▼ to select the [SETUP] menu icon [Y] and then press ▶.**

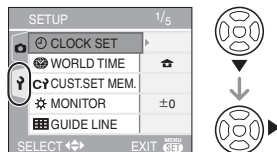

- 3 Press ▲/▼ to select [TRAVEL DATE] and then press ▶.**

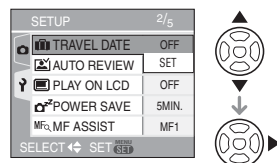

- 4 Press ▼ to select [SET] and then press [MENU/SET].**

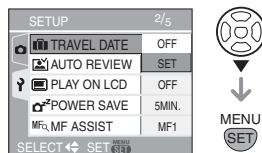

- 5 Press ▲/▼/◀/▶ to select the date.**



◀/▶: Select the desired item.

▲/▼: Set the year, month and date.

- 6 Press [MENU/SET] twice to close the menu.**

7 Take a picture.



- Ⓐ: The number of days that have passed since the departure date
- The current date and time and which day of the vacation it is are displayed for about 5 seconds at the bottom of the screen if the camera is turned on when the travel date is set, after setting the clock, departure date or travel date, after changing the world time setting and after switching from playback mode to another mode.
 - When [TRAVEL DATE] is set,  appears on the lower right of the screen.

■ Canceling the travel date

If you leave [TRAVEL DATE] set to [SET], the number of days that have passed since the departure date will continue to be recorded.

When the vacation is finished, set [TRAVEL DATE] to [OFF] on the screen shown in step 4 and then press [MENU/SET] twice.



- The travel date is calculated using the date in the clock setting (P26) and the departure date you set. If you set [WORLD TIME] (P73) to the travel destination, the travel date is calculated using the date in the clock setting and the travel destination setting.
- The travel date setting is memorized even if the camera is turned off.
- If you set a departure date and then take a picture on a date before this departure date, [-] (minus) is displayed in orange

and the day of the vacation that you took the picture is not recorded.

- If you set a departure date and then change the clock setting to the date and time at the travel destination, [-] (minus) is displayed in white and the day of the vacation that you took the picture is recorded when the travel destination date is, for example, one day before the departure date.
- If [TRAVEL DATE] is set to [OFF], the number of days that have passed since the departure date will not be recorded even if you set the travel date or the clock. Even if [TRAVEL DATE] is set to [SET] after taking the pictures, which day of the vacation you took them is not displayed.
- If you set a departure date when the clock is not set, the message [PLEASE SET THE CLOCK] appears. In this case, set the clock. (P26)

Displaying the time at the travel destination (World Time)



If you set your home area and the travel destination area when traveling abroad etc., the local time at the travel destination area can be displayed on the screen and recorded on the pictures taken.

- Select [CLOCK SET] to set the current date and time in advance. (P26)

1 Press [MENU/SET] and then press ◀.

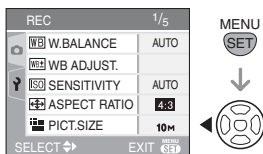

2 Press ▼ to select the [SETUP] menu icon [⌵] and then press ▶.

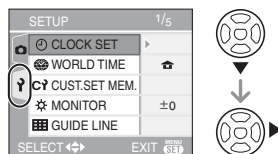

3 Press ▲/▼ to select [WORLD TIME] and then press ▶.

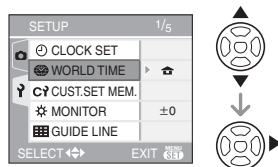

- If you are setting the world time for the first time, the message [PLEASE SET THE HOME AREA] appears. If this

message appears, press [MENU/SET] and then set home area from the screen shown in step 2 in "Setting the home area [HOME]".

■ Setting the home area [HOME] (Perform steps 1, 2 and 3.)

- 1 Press ▼ to select [HOME] and then press [MENU/SET].

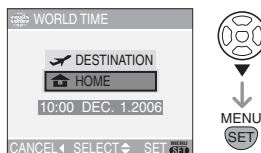

- 2 Press ◀/▶ to select your home area and then press [MENU/SET].



- The current time is displayed on the top left of the screen and the time difference from GMT "Greenwich Mean Time" is displayed on the bottom left of the screen.
- If daylight saving time [☀] is used at the home area, press ▲. Press ▲ again to return to the original time.
- The daylight saving time setting for the home area does not advance the current time. Advance the clock setting by one hour. (P26)

■ Finishing setting the home area

- If you are setting the home area for the first time, the screen returns to that shown in step 1 of "Setting the home area [HOME]" after you press [MENU/SET] to set your home area. Press ◀ to return to the screen shown in step 3 and then press [MENU/SET] to close the menu.

- If you are setting the home area for the second time etc., the screen returns to that shown in step **3** after you press [MENU/SET] to set your home area. Press [MENU/SET] again to close the menu.

■ Setting the travel destination area (Perform steps **1**, **2** and **3**.)

- 1** Press **▲** to select [DESTINATION] and then press [MENU/SET] to set.



- (A): Depending on the setting, the time at the travel destination area or the home area is displayed.

- If you are setting the travel destination area for the first time, the date and time are displayed as shown in the screen above.
- 2** Press **◀/▶** to select the area the travel destination is in and then press [MENU/SET] to set.

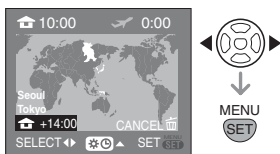

- The current time at the selected travel destination area is displayed on the top right of the screen and the time difference from the home area is displayed at the bottom left of the screen.
- If daylight saving time [**☀**] is used at the travel destination, press **▲**. (The time advances by one hour.) Press **▲** again to return to the original time.

- The names of major cities in the selected area are displayed. Also, the time difference between the selected area and the home area is displayed on the bottom left of the screen. (Refer to P75 for information about the names of the major cities that are displayed.)

- 3** Press [MENU/SET] to close the menu.

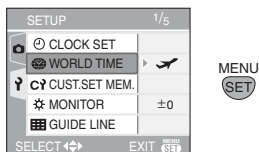

- The icon changes from [**🏠**] to [**✈️**] after setting the travel destination.



- Return the setting to [HOME] when the vacation is finished by performing steps **1**, **2**, **3** and then steps **1** and **2** of "Setting the home area [HOME]".
- If you cannot find the travel destination in the areas displayed on the screen, set by the time difference from the home area.

Location candidates for World Time settings

Offset from GMT	Listed location name			
-11	Midway Islands	Samoa		
-10	Hawaii	Honolulu	Tahiti	
-9	Alaska	Anchorage		
-8	Vancouver	Seattle	Los Angeles	
-7	Denver	Phoenix		
-6	Chicago	Houston	Mexico City	
-5	Toronto	New York	Miami	Lima
-4	Caracas	Manaus	La Paz	
-3:30	Newfoundland			
-3	Rio de Janeiro	Sao Paulo	Buenos Aires	
-2	Fernando de Noronha			
-1	Azores			
0	London	Casablanca		
+1	Berlin	Paris	Rome	Madrid
+2	Helsinki	Athens	Cairo	Johannesburg
+3	Moscow	Kuwait	Riyadh	Nairobi
+3:30	Tehran			
+4	Dubai	Abu Dhabi		
+4:30	Kabul			
+5	Islamabad	Karachi	Male	
+5:30	Delhi	Kolkata	Mumbai	Chennai
+5:45	Kathmandu			
+6	Dacca	Colombo		
+6:30	Yangon			
+7	Bangkok	Jakarta		
+8	Beijing	Hong Kong	Kuala Lumpur	Singapore
+9	Seoul	Tokyo		
+9:30	Adelaide			
+10	Guam	Sydney		
+11	Solomon Islands	New Caledonia		
+12	Fiji	Auckland	Wellington	
+12:45	Chatham Islands			

* "GMT" is an abbreviation of "Greenwich Mean Time".

Motion Picture Mode



1 Press the shutter button halfway to focus and then press it fully to start recording.

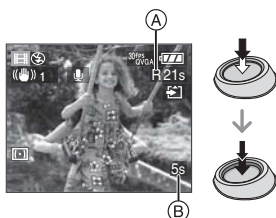

- When the subject is focused, the focus indication lights.
- The aperture value is fixed to the setting when recording starts (first frame).
- The available recording time **A** is displayed on the top right and the elapsed recording time **B** is displayed on the bottom right of the screen. For example, 1 hour 20 minutes and 30 seconds is displayed as [1h20m30s].
- The available recording time and the elapsed recording time are approximations.
- Audio recording starts simultaneously with the camera's built-in microphone.
- If you rotate the focus ring or zoom ring while recording motion pictures, a grinding noise may be recorded.

2 Press the shutter button fully to stop recording.

- If the card becomes full in the middle of recording, the camera stops recording automatically.

■ Changing the settings for the aspect ratio and the picture quality

1 Press [MENU/SET].

2 Press ▲/▼ to select [ASPECT RATIO] and then press ►.

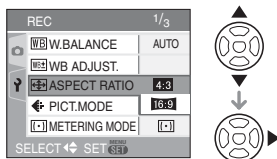

3 Press ▲/▼ to select the item and then press [MENU/SET].

4 Press ▲/▼ to select [PICT.MODE] and then press ►.

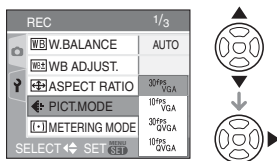

5 Press ▲/▼ to select the item and then press [MENU/SET].

If you selected [4:3] on the screen shown in step 2

Item	Picture size	fps
[30fpsVGA]	640×480 pixels	30
[10fpsVGA]		10
[30fpsQVGA]	320×240 pixels	30
[10fpsQVGA]		10

If you selected [16:9] on the screen shown in step 2

Item	Picture size	fps
[30fps16:9]	848×480 pixels	30
[10fps16:9]		10

- fps “frames per second”; This refers to the number of frames used in 1 second.

- You can record smoother motion pictures with “30 fps”.
- You can record longer motion pictures with “10 fps” although the picture quality is lower.
- The file size with [10fpsQVGA] is small so it is suitable for e-mails.

6 Press [MENU/SET] to close the menu.

- You can also press the shutter button halfway to close the menu.



- **The focus range is 30 cm (0.98 feet) [AF MACRO: 5 cm (0.16 feet)] (Wide)/ 2 m (6.56 feet) (Tele) to ∞.**
- Refer to P131 for information about the available recording time.
- The available recording time is an approximation.
(It varies depending on the recording condition and the types of Card.)
- The available recording time changes with subjects.
- The available recording time displayed on the screen may not decrease regularly.
- Motion pictures cannot be recorded without audio.
- This unit does not support recording motion pictures on MultiMediaCards.
- **When you set the picture quality to [30fpsVGA] or [30fps16:9], we recommend using a high speed Card with “10MB/s” or greater displayed on the package.**
- **Depending on the type of SD Memory Card or SDHC Memory Card, recording may stop in the middle.**
- Depending on the type of SD Memory Card or SDHC Memory Card, the card access indication may appear for a while after recording motion pictures. This is not a malfunction.
- When motion pictures recorded with the camera are played back on other

equipment, the quality of the picture and sound may deteriorate and it may not be possible to play them back. Also the recording information may not be displayed correctly.

- In motion picture mode [M], you cannot use the direction detection function and the review function. You cannot set [MODE2] on the optical image stabilizer function.
- The bundled software includes QuickTime to play back motion picture files recorded with the camera on the PC.

Displaying Multiple Images (Multi Playback)



1 Rotate the front dial to the left to display multiple images.

(Screen when 9 images are displayed)

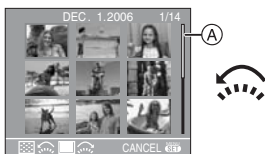

1 image → 9 images →

25 images → Calendar screen display

- After the multiple images are displayed, rotate the front dial further towards the left to display 25 images and the calendar screen (P79). Rotate the front dial towards the right to return to the previous screen.
- When you switch to multiple images, a scroll bar **A** appears. You can confirm the location of the displayed picture in all the recorded pictures with this scroll bar.

2 Press ▲/▼/◀/▶ to select a picture.



- The recording date and number of the selected picture and the total number of recorded pictures are displayed.
- Depending on the recorded picture and the setting, the following icons will appear.

- [★] (Favorites)
- [📺] (Motion picture)
- [👶] ([[BABY1]/[[BABY2] in scene mode, age in months, age in years etc.)
- [📅] (Travel date)
- [🔄] (Flip animation)

■ Example of 25 images



■ To return to normal playback

Rotate the front dial towards the right or press the [MENU/SET] button.

- The picture appears framed in orange.

■ To delete a picture during multi playback

- 1 Press ▲/▼/◀/▶ to select a picture and then press [🗑️].
- 2 Press ▲ to select [YES].
- 3 Press [MENU/SET].



- Even if the indications on the screen are turned off in normal playback mode (P43), the recording information etc. appears on the screen in multi playback. If you return to the previous screen, the indications on the screen are displayed as in normal playback mode.
- Pictures will not be displayed in the rotated direction even if [ROTATE DISP.] is set to [ON]. (P104)

Displaying pictures by recording date

(Calendar playback)



You can display pictures by recording date using the calendar playback function.

1 Rotate the front dial towards the left to display the calendar screen.



- The recording date of the picture selected in the playback screen becomes the date selected when the calendar screen is first displayed.
- If there are multiple pictures with the same recording date, the first picture recorded on that day is displayed.
- The calendar is displayed monthly.

2 Press ▲/▼/◀/▶ to select the date to be played back.

- ◀/▶: Select the date
- ▲/▼: Select the month
- If there were no pictures recorded during a month, the month is not displayed.

3 Press [MENU/SET] to display the pictures that were recorded on the selected date.

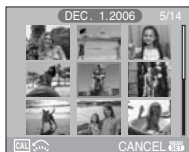

- The pictures that were recorded on the selected date are displayed on the 9 images playback screen.
- Rotate the front dial towards the left to return to the calendar screen.

4 Press ▲/▼/◀/▶ to select a picture and then press [MENU/SET].

- The selected picture is displayed on the 1 image playback screen.

■ To return to the 1 image playback screen.

After the calendar screen is displayed, rotate the front dial towards the right to display 25 images, 9 images and the 1screen. (P78)



- The pictures are displayed without being rotated even if you set [ROTATE DISP.] to [ON]. (P104)
- You can display the calendar between January 2000 and December 2099.
- If the recording date of the picture selected in 25 image multi playback is not between January 2000 and December 2099, the camera automatically displays it in the oldest calendar date.
- If you take pictures after setting the travel destination in [WORLD TIME] (P73), the pictures are displayed by the dates at the travel destination in calendar playback.
- Pictures processed on a PC or other equipment may be displayed with dates different from the actual recording dates.
- If the date is not set in the camera (P26), the recording date is set as January 1st, 2006.

Using the Playback Zoom



1 Rotate the front dial towards the right to enlarge the picture.

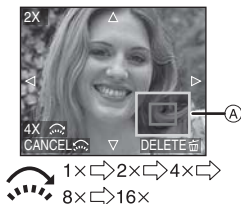

- When you rotate the front dial towards the left after the picture is enlarged, the magnification becomes lower. When you rotate the front dial towards the right, the magnification becomes higher.
- When you change the magnification, the zoom position indication (A) appears for about 1 second so that you can check the position of the enlarged section.

2 Press ▲/▼/◀/▶ to move the position.

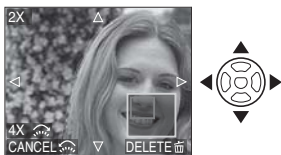

- When you move the position to be displayed, the zoom position indication appears for about 1 second.

■ To stop using the playback zoom

Rotate the front dial towards the left or press [MENU/SET].

■ To delete a picture during the playback zoom

- 1 Press [DELETE].
- 2 Press ▲ to select [YES].
- 3 Press [MENU/SET].



- Even if the indications on the screen are turned off in normal playback mode (P43), the magnification and operation appear on the screen when the playback zoom is activated. You can switch between displaying or not displaying the indications on the screen by pressing [DISPLAY]. When you set the magnification to 1×, the indications on the screen are displayed as in normal playback mode.
- The more a picture is enlarged, the more its quality deteriorates.
- If you want to save the enlarged picture, use the trimming function. (P109)
- The playback zoom may not operate if pictures have been recorded with other equipment.

Playing Back Motion Pictures/Pictures with Audio



■ Motion pictures

Press ◀/▶ to select a picture with a motion picture icon [30fps_VGA] / [10fps_VGA] / [30fps_QVGA] / [10fps_QVGA] / [30fps_16:9] / [10fps_16:9] and then press ▼ to play back.

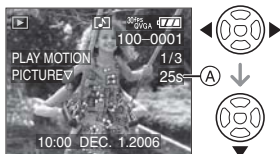

- The motion picture recording time (A) is displayed on the screen. After playback starts, the motion picture recording time disappears and the elapsed playback time is displayed on the bottom right of the screen.

For example, 1 hour 20 minutes and 30 seconds is displayed as [1h20m30s].

- The cursor displayed during playback is the same as ▲/▼/◀/▶.
- Press ▼ again to stop motion picture playback and return to the normal playback screen.



Fast forwarding/Fast rewinding

Press and hold ◀/▶ during motion picture playback.

- ◀: Fast rewind
- ▶: Fast forward

- The camera returns to normal motion picture playback when ◀/▶ is released.

To pause

- Press ▲ during motion picture playback.
- Press ▲ again to cancel pause.

■ Pictures with audio

Press ◀/▶ to select a picture with the audio icon [] and then press ▼ to play back.



- Refer to [AUDIO REC.] (P89) and [AUDIO DUB.] (P108) for information about how to create still pictures with audio.



- Sound can be heard through the speaker. Refer to [VOLUME] (P29) for information about how to adjust the volume in the [SETUP] menu.
- The file format that can be played back with this camera is QuickTime Motion JPEG.
- Please note that the bundled software includes QuickTime to play back motion picture files created with the camera on the PC. (P113)
- Some QuickTime Motion JPEG files recorded by a PC or other equipment may not play back on the camera.
- If you play back motion pictures that have been recorded with other equipment, the picture quality may deteriorate or the pictures may not play back.
- When using a high capacity card, it is possible that fast rewinding may be slower than usual.
- You cannot use the following functions with motion pictures and pictures with audio.
 - Playback zoom (While playing back or pausing motion pictures and while playing audio)
 - [ROTATE DISP.]/[ROTATE]/[AUDIO DUB.] (Motion pictures only)
 - [RESIZE]/[TRIMMING]/[ASPECT CONV.]

Using the [REC] Mode Menu



Increase the variety of pictures you can take by setting color effect, picture adjustment etc.

- Set the mode dial to the desired recording mode.
- Menu items differ depending on the mode selected with the mode dial (P6). This page describes how to set [AUDIO REC.] in program AE mode [P]. (Refer to P83 to 101 for each menu item.)
- Select [RESET] in the [SETUP] menu to return the menu settings to the initial settings at the time of purchase. (P30)

1 Press [MENU/SET].

2 Press ▲/▼ to select the menu item.

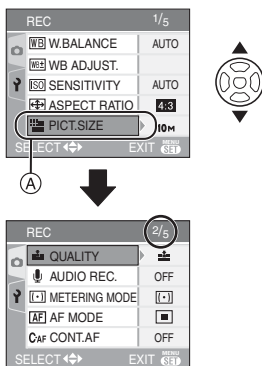

- Press ▼ at (A) to switch to the next menu screen.

3 Press ►, press ▲/▼ to select the setting and then press [MENU/SET].

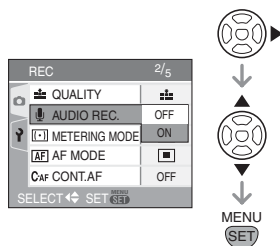

4 Press [MENU/SET] to close the menu.

- You can also press the shutter button halfway to close the menu.

■ About the menu screen items

- There are 5 menu screens (1/5, 2/5, 3/5, 4/5 and 5/5).
- You can switch menu screens from any menu item by rotating the front dial.

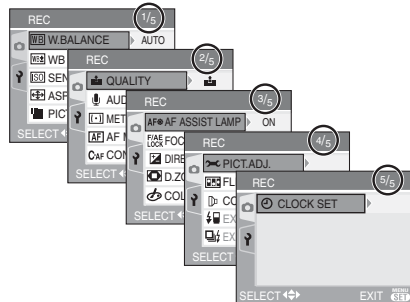

■ Using FUNCTION setting



You can use the [FUNCTION] button to easily set the following 6 items when recording.

- AF mode (P90)
- Metering mode (P89)
- White balance (P83)
- ISO sensitivity (P85)
- Picture size (P87)
- Quality (P87)

1 Press [FUNCTION] when recording.



2 Press ▲/▼/◀/▶ to select the menu item and then press [FUNCTION] to close the menu.

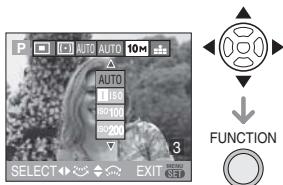

- You can select menu items by rotating the front dial or rear dial.



- The menu items that can be set differ depending on the recording mode.
- The [WB SET] (White Set) setting for white balance does not appear when using the [FUNCTION] setting.

[WB.BALANCE]

Adjusting the hue for a more natural picture



Press [MENU] to display the [REC] mode menu and select the item to set. (P82)
This function allows you to reproduce a white color close to real life in pictures recorded under sunlight, halogen lighting etc. in which the white color may appear reddish or bluish. Select a setting that matches the recording conditions.

[AUTO]	for auto setting (auto white balance)
(Daylight)	for recording outdoors on a bright day
(Cloudy)	for recording outdoors on a cloudy day
(Shade)	for recording outdoors in the shade on a brightday
(Halogen)	for recording under halogen lighting
(Flash)	for recording with the flash only
(White set 1)	for using the preset white balance
(White set 2)	
SET (White set)	for setting the white balance again

■ Auto white balance

The available white balance range is shown in the following illustration. When you take a picture beyond the available white balance range, the picture may appear reddish or bluish. Even when you take a picture inside the range shown in the illustration, auto white balance may not operate properly if there are many light sources or there is no color close to white. In these cases, set the white balance to a mode other than [AUTO].

- 1 Auto white balance will work in the following range.
- 2 Blue sky
- 3 Cloudy sky (Rain)
- 4 Shade
- 5 TV screen
- 6 Sunlight
- 7 Sunlight
- 8 White fluorescent light
- 9 Incandescent light bulb
- 10 Sunrise and sunset

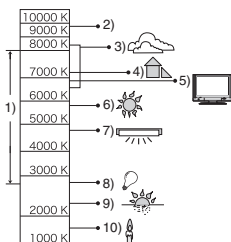

K=Kelvin Color Temperature

■ Setting the white balance manually

[MENU/SET]

Use this to set the white balance manually.

- 1 Select [MENU/SET] and then press [MENU/SET].
- 2 Select [WHITE SET 1] or [WHITE SET 2] and then press [MENU/SET].

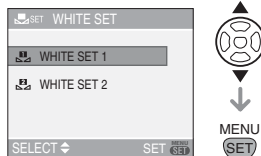

- 3 Aim the camera at a sheet of white paper etc. so that the frame in the center is filled by the white object only and then press [MENU/SET].

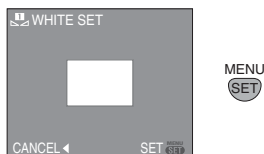

- 4 Press [MENU/SET] twice to close the menu.
 - You can also press the shutter button halfway to finish.



- When you take a picture with the flash, the white balance is automatically adjusted (except for [WB] / [WB]). However, the white balance may not be properly adjusted if the flash level is insufficient.
- The white balance cannot be set in auto mode [A] and scene mode.

[WB ADJUST.]

Finely adjusting the white balance

P A S M C

Press [MENU] to display the [REC] mode menu and select the item to set. (P82) You can adjust the white balance finely when you cannot acquire the desired hue by setting the white balance.

1 Press ▲/▼/◀/▶ to finely adjust the white balance.

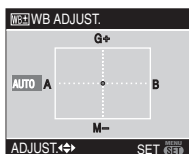

- ◀ : A (AMBER: ORANGE)
- ▶ : B (BLUE: BLUISH)
- ▲ : G+ (GREEN: GREENISH)
- ▼ : M- (MAGENTA: REDDISH)

2 Press [MENU/SET] to finish.

- You can also press the shutter button halfway to finish.
- If you finely adjust the white balance to A (amber), the white balance icon on the LCD monitor will change to orange. If you finely adjust the white balance to B (blue), the white balance icon on the LCD monitor will change to blue.
- If you finely adjust the white balance to G+ (green) or M- (magenta), [+] (e.g. :) or [-] (e.g. :) appears beside the white balance icon on the LCD monitor.
- Select the center point if you are not finely adjusting the white balance.



- You can finely adjust the white balance independently for each white balance item.
- The white balance fine adjustment setting is reflected in the picture when using the flash.
- The white balance fine adjustment setting is memorized even if the camera is turned off.
- You cannot finely adjust the white balance when [COL.EFFECT] (P94) is set to [COOL], [WARM], [B/W] or [SEPIA].
- The fine adjustment levels in [] or [] return to the standard setting (center point) if you reset the white balance in [SET].

**[SENSITIVITY]**

Setting the light sensitivity

P A S M C

Press [MENU] to display the [REC] mode menu and select the item to set. (P82) ISO is a measure of sensitivity to light. The higher the sensitivity is set, the less light is needed to take a picture so the camera becomes more suitable for recording in dark places.

ISO sensitivity	100	←	→	1600
Use in bright places (e.g. outdoors)	Suitable			Not suitable
Use in dark places	Not suitable			Suitable
Shutter speed	Slow			Fast
Noise	Less			Increased

AUTO	The ISO sensitivity is automatically adjusted according to the brightness.
ISO	The ISO sensitivity is adjusted according to the movement of the subject and the brightness.
100	The sensitivity is fixed to various settings.
200	
400	
800	
1600	

- When setting to [AUTO], the ISO sensitivity is automatically adjusted from [ISO100] to [ISO200] according to the brightness. (It can be adjusted from [ISO100] to [ISO400] when using the flash.)

■ About [ISO] (Intelligent ISO sensitivity control)

The camera detects the movement of the subject near the center of the screen and then sets the optimal ISO sensitivity and shutter speed according to the movement and the brightness of the subject.

- Jitter is avoided when taking pictures indoors of a moving subject by increasing the ISO sensitivity and making the shutter speed faster.



1/125 ISO800

- Noise is avoided when taking pictures indoors of a subject with no movement by decreasing the ISO sensitivity.



1/30 ISO200

- When you press the shutter button halfway, [ISO] (A) appears. When you press the shutter button fully, the shutter speed is displayed for a while.



- If you select [ISO], digital zoom and auto bracket cannot be used.
- Depending on the brightness and how fast the subject is moving, jitter may not be avoided even if [ISO] is selected.
- The camera may not be able to detect the movement of the subject in the following cases.
 - When the moving subject is small
 - When the moving subject is at the edge of the screen
 - When the subject starts moving the instant the shutter button is pressed fully
- The setting is fixed to [ISO] in auto mode [A] and [SPORTS] (P65) and [BABY1]/[BABY2] (P69) in scene mode.
- Program shift cannot be activated when the ISO sensitivity is set to [ISO].
- The ISO sensitivity cannot be set to [AUTO] or [ISO] in Aperture-priority AE, Shutter-priority AE or Manual exposure.
- ISO sensitivity is automatically set to the following optimal value in [HIGH SENS.] (P70) in scene mode [ISO3200].

- ISO sensitivity cannot be set in motion picture mode [H].
- To avoid picture noise, we recommend reducing the ISO sensitivity, setting [NOISE REDUCTION] in [PICT.ADJ.] to [HIGH] or setting the items except [NOISE REDUCTION] to [LOW] to take pictures. (P94)
- Refer to P57 for information about Shutter speed.





[ASPECT RATIO]

Setting the aspect ratio of pictures



Press [MENU] to display the [REC] mode menu and select the item to set. (P82)
By changing the aspect ratio, you can select an angle of view that matches the subject.

4:3	Select to take pictures with the same aspect ratio as a 4:3 TV or a computer monitor. 
3:2	Select to take pictures with the same 3:2 aspect ratio as 35 mm film. 
16:9	This is suitable for landscapes etc. where a wide view is preferable. This is also suitable for playing back pictures on a wide-screen TV, high-definition TV etc. 



- In motion picture mode [H], you can select [4:3] or [16:9]. (P76)
- The ends of the recorded pictures may be cut at printing. (P127)

[PICT.SIZE]/[QUALITY]



Setting a picture size and quality



that matches your use of the pictures



Press [MENU] to display the [REC] mode menu and select the item to set. (P82)
A digital picture is made of numerous dots called pixels. Although you cannot see the difference on the camera's screen, the more pixels the finer the picture will be when it is printed on a large piece of paper or displayed on a computer monitor. Picture quality refers to the compression rate when saving digital pictures.

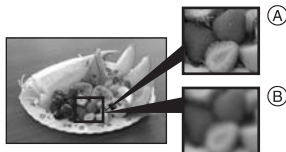





- Ⓐ Many pixels (Fine)
- Ⓑ Few pixels (Rough)





■ Number of pixels

You can print pictures more clearly when a large picture size [10M] (10M) is selected. When a smaller picture size [2M] (2M EZ) is selected, you can record more pictures and attach them to an e-mail or post them on a website because their file size is small.



■ When the aspect ratio is [4:3].

 (10M)	3648×2736 pixels
 (8M EZ)	3264×2448 pixels
 (5M EZ)	2560×1920 pixels
 (3M EZ)	2048×1536 pixels
 (2M EZ)	1600×1200 pixels

■ When the aspect ratio is [3:2].



 (8.5M)	3600×2400 pixels
 (7M EZ)	3248×2160 pixels
 (4.5M EZ)	2560×1712 pixels
 (2.5M EZ)	2048×1360 pixels

■ When the aspect ratio is [16:9].

 (7M)	3584×2016 pixels
 (5.5M EZ)	3072×1728 pixels
 (2M EZ)	1920×1080 pixels

■ Quality

You can increase the number of recordable pictures without changing the picture size if quality is set to .

	Fine (Low compression): This gives priority to picture quality. Picture quality will be high.
	Standard (High compression): This gives priority to the number of recordable pictures. Standard quality pictures are recorded.
RAW	RAW file: Set this to process the pictures on a PC.



- The number of pixels that can be selected differs depending on the aspect ratio. If you change the aspect ratio, set the picture size.
- “EZ” is an abbreviation of “Extended optical Zoom”. This is a function which further extends the optical zoom ratio. If you select a picture size with EZ displayed, the zoom ratio is extended to a

maximum of 21.4× when the digital zoom is set to [OFF]. (P37)

- The extended optical zoom does not work in [HIGH SENS.] in scene mode so the picture size for [EZ] is not displayed.
- In motion picture mode , the picture size is fixed to VGA (640×480 pixels), QVGA (320×240 pixels) or 16:9 (848×480 pixels).
- When the quality is set to [RAW]
 - A JPEG file is also created simultaneously. Its quality is equal to [STANDARD] and its size is fixed to ([10M], [8.5M], [7M]).
 - When the RAW file is deleted on the camera, the created JPEG file is also deleted.
- Pictures may appear mosaic depending on the subject and the recording conditions.
- Refer to P129 for information about the number of recordable pictures.
- The number of recordable pictures depends on the subject.
- The number of recordable pictures displayed on the screen may not correspond with recorded pictures.
- When the quality is set to [RAW], the digital zoom cannot be used.
- The quality cannot be set to [RAW] in the [HIGH SENS.] mode (P70).
- You cannot select the following functions when the quality is set to [RAW].
 - Audio Dubbing
 - Continuous mode
 - Resize
 - Trimming
 - Audio Recording
 - Auto Bracket
- You can enjoy more advanced picture editing if you use RAW files. You can save RAW files in a file format (JPEG, TIFF etc.) that can be displayed on your PC etc.

**[AUDIO REC.]**

Recording still pictures with audio



Press [] to display the [REC] mode menu and select the item to set. (P82)
You can record audio with the still picture if this is set to [ON]. This means you can record the conversation that took place when you were recording or an explanation of the picture.

- [] appears on the screen when you set [AUDIO REC.] to [ON].
- Focus on the subject and press the shutter button to start recording. Recording will automatically stop about 5 seconds later. There is no need to press and hold the shutter button.
- Audio is recorded with the built-in microphone on the camera.
- If you press [MENU/SET] during audio recording, the audio recording is canceled. The audio is not recorded.
- The total number of pictures that can be stored on each card will decrease slightly when audio is recorded with each picture.



-
- You cannot record pictures with audio in the following cases.
 - When recording with Auto Bracket.
 - When recording in continuous mode.
 - When the quality is set to [RAW].
 - When the scene mode is set to [STARRY SKY].
 - **If you rotate the focus ring or zoom ring, a grinding noise may be recorded.**

[METERING MODE]

Deciding the method to measure brightness



Press [] to display the [REC] mode menu and select the item to set. (P82)
You can switch to the following metering modes.

	<p>Multiple: This is the method in which the camera measures the most suitable exposure by judging the allocation of brightness on the whole screen automatically. Usually, we recommend using this method.</p>
	<p>Center weighted: This is the method used to concentrate on the subject in the center of the screen while also considering the rest of the screen.</p>
	<p>Spot: This is the method to measure only the subject in the spot metering target (A).</p> <div data-bbox="598 841 735 924" data-label="Diagram"> <p>The diagram shows a rectangular frame representing the camera's viewfinder. Inside the frame, there are four small squares arranged in a cross pattern, representing the center of the frame. A circle labeled 'A' is positioned to the right of the center, with a horizontal line pointing from the center of the frame to the circle, indicating that the spot metering target is located at the center of the frame.</p> </div>

**[AF MODE]**

Setting the focus method



Press to display the [REC] mode menu and select the item to set. (P82)
Select the mode that matches the recording conditions and the composition.

**9-area-focusing:**

The camera focuses on any of 9 focus areas. This is effective when the main subject is not in the center of the image.

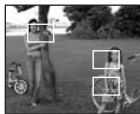
**3-area-focusing (High speed):**

The camera quickly focuses on any of 3 focus areas – left, right or center. This is effective when the main subject is not in the center of the image..

**1-area-focusing (High speed):**

The camera quickly focuses on the subject in the AF area in the center of the screen.

**1-area-focusing:**

The camera focuses on the subject in the AF area in the center of the screen.

**Spot-focusing:**

The camera focuses on a limited small area in the screen.

**■ About and**

- You can focus on the subject more quickly than other AF modes.
- The picture may stop moving for a moment before being brought into focus when you press the shutter button halfway. This is not a malfunction.

■ Selecting the AF area

When selecting 1-area-focusing or 1-area-focusing (High speed), the AF area can be selected as shown in the following figure. When using Spot you can also move the spot metering target to match the AF area.

- 1 Set the Focus switch to [AF] or [AF MACRO].
- 2 While pressing the [FOCUS] button, use /// to move the AF area.

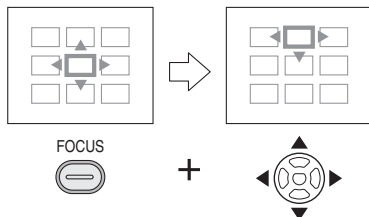

- 3 Release the [FOCUS] button to set.
 - The following operations will return the AF area to the previous one
 - Setting the mode dial to auto mode .
 - When power save mode is activated.
 - Turning the camera off.



- The AF area displayed on the center of the screen is larger than usual when using the digital zoom or when taking pictures in dark places.



- The camera is focusing on all the AF areas when multiple AF areas (max. 9 areas) light at the same time. The focus position is not predetermined. It is set to a position automatically determined by the camera at the time of focusing. If you want to determine the focus position to take pictures, switch the AF mode to [□H], [□] or [□].
- Switch the AF mode to [□H] or [□] mode if it is difficult to focus using [□].

[CONT.AF]

CAF Continuously focusing on a subject



Press [MENU] to display the [REC] mode menu and select the item to set. (P82) This mode allows you to compose a picture more easily by always focusing on the subject.

The time required for focusing when the shutter button is pressed halfway will be reduced when the AF mode is set to [□], [□H] or [□].

- The [CAF] indication appears when it is set to [ON].



- The battery will be consumed faster than usual.
- It may take time to focus on the subject after rotating the zoom ring from Wide to Tele or suddenly changing the subject from a distant one to a nearby one.
- Press the shutter button halfway again when it is difficult to focus on the subject.
- You can have different [CONT.AF] settings when recording motion pictures and still pictures.
- The [CONT.AF] setting is fixed to [OFF] in [NIGHT PORTRAIT] (P66), [NIGHT SCENERY] (P66), [PANNING] (P66), [FIREWORKS] (P68) and

[STARRY SKY] (P68) in scene mode, in auto mode [A] and when manual focus is set.

[AF ASSIST LAMP]

AF* Focusing in low light conditions becomes easier



Press [MENU] to display the [REC] mode menu and select the item to set. (P82) Illuminating the subject makes it easier for the camera to focus when recording in low light conditions that make focusing difficult. If the AF assist lamp is set to [ON], an AF area with a size wider than usual is displayed and the AF assist lamp (A) turns on when you press the shutter button halfway in dark places etc.



ON	The AF assist lamp turns on in low light conditions. At this time, the AF assist lamp icon [AF*] appears on the screen. The effective range of the AF assist lamp is 1.5 m (4.92 feet).
OFF	The AF assist lamp does not turn on.



- Be careful about the following when using the AF assist lamp.
 - Do not look at the AF assist lamp from close up.
 - Detach the lens hood.
 - Do not cover the AF assist lamp with your fingers or other objects.
- When the AF assist lamp is turned on, the AF area on the center of the screen is displayed and it is larger than usual. (P90)
- When you do not want to use the AF assist lamp (e.g. when taking pictures of animals in dark places), set the

[AF ASSIST LAMP] to [OFF]. In this case, it will become more difficult to focus on the subject.

- In auto mode ([A]), the [AF ASSIST LAMP] setting is fixed to [ON].
- A vignetting effect may appear on the circumference of the AF assist lamp because the AF assist lamp may be obscured by the lens, however, this does not cause a problem with the performance of the camera.
- The setting for the [AF ASSIST LAMP] is fixed to [OFF] in [SCENERY] (P65), [NIGHT SCENERY] (P66) [PANNING] (P66) and [FIREWORKS] (P68) in scene mode.

[FOCUS/AE LOCK] Locking the focus and exposure

P A S M C **SCN**

Press  to display the [REC] mode menu and select the item to set. (P82) This is a technique for setting the focus and the exposure in advance when the subject is outside the focus area or when the contrast is too sharp and the appropriate exposure cannot be achieved.

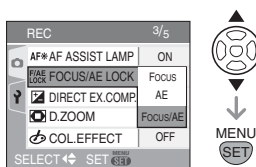

- When [FOCUS] is selected
(Locking the focus only)

1 Aim the AF area at the subject.

2 Press [FOCUS/AE LOCK] to lock the focus.

- Press [FOCUS/AE LOCK] button again to cancel it.

- The focus lock indication [**FOCL**] lights when the subject is focused.

3 Move the camera to compose the picture and then press the shutter fully.

- When [AE] is selected
(Locking the exposure only)

1 Aim the AF area at the subject.

2 Press [FOCUS/AE LOCK] to lock the exposure.

- Press [FOCUS/AE LOCK] again to cancel it.
- The AE lock indication [**AE-L**], the aperture value and the shutter speed appear when the exposure is set.

3 Move the camera to compose the picture and then press the shutter fully.

- When [FOCUS/AE] is selected
(Locking the focus and the exposure)

1 Aim the AF area at the subject.

2 Press [FOCUS/AE LOCK] to lock the focus and the exposure.

- Press [FOCUS/AE LOCK] button again to cancel.
- When the subject is focused and the exposure is set, the focus/AE lock indication [**FOCL**], the aperture value and the shutter speed appear.

3 Move the camera to compose the picture and then press the shutter fully.

- When in manual focus (MF)

After focusing at the position where you want to record the subject, press the [FOCUS/AE LOCK] button to lock the focus.

- If you rotate the focus ring while the focus is locked, the focus lock indication [FOC-L] flashes red.



- The exposure is set, even if the brightness of the subject changes.
- The subject can be focused again by pressing the shutter button halfway even when AE is locked.
- Press the [FOCUS/AE LOCK] button once more to cancel the AE lock.
- Program shift can be set even when AE is locked.
- You can lock the focus and the exposure by pressing the [FOCUS/AE LOCK] button. You do not need to press the shutter halfway.
- The AE lock function cannot be used in the Manual exposure mode, scene mode or motion picture mode.

 **[DIREC. EX. COMP.]**
For rapid exposure compensation

P A S M C  **SCN**

Press  to display the [REC] mode menu and select the item to set. (P82)
You can use the front dial or the rear dial for operation.

1 Select the front or rear dial.

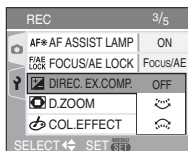





- You can directly compensate the exposure with the selected dial.
- Select [OFF] if you are not going to compensate the exposure with the dial.



2 Press [MENU/SET] to close the menu.

■ Dial operation



- When [DIREC. EX. COMP.] is set to [OFF]

Exposure mode		
P	—	Program shift
A	Aperture	—
S	—	Shutter speed
M	Aperture	Shutter speed
SCN	—	—
	—	—

- When [DIREC. EX. COMP.] is set to .

Exposure mode		
P	Program shift	Exposure compensation
A	Aperture	
S	Shutter speed	Shutter speed
M	Aperture	
SCN	—	Exposure compensation
	—	

- When [DIREC. EX. COMP.] is set to .

Exposure mode		
P	Exposure compensation	Program shift
A		Aperture
S	Aperture	Shutter speed
M		Shutter speed
SCN	Exposure compensation	—
		—



- When a memorized custom mode setting is selected, this memorized setting has priority. (However, this is not the case when Manual exposure is set in custom set.)
- You cannot directly compensate the exposure in the following cases.
 - When manually setting the exposure.
 - When in auto mode [A].

[COL.EFFECT]

Setting color effects for the recorded pictures



Press [MENU] to display the [REC] mode menu and select the item to set. (P82)
Select a color effect that matches the recording conditions and your image of the recording.

[COOL]	The picture becomes bluish.
[WARM]	The picture becomes reddish.
[B/W]	The picture becomes black and white.
[SEPIA]	The picture becomes sepia.

[PICT.ADJ.]

Adjusting the picture quality for the recorded pictures



Press [MENU] to display the [REC] mode menu and select the item to set. (P82)
Select an effect that matches the recording situation and your image of the recording.

Picture quality**[CONTRAST]**

[HIGH]	Increases the difference between the brightness and the darkness in the picture.
[LOW]	Decreases the difference between the brightness and the darkness in the picture.

[SHARPNESS]

[HIGH]	The picture is sharply defined.
[LOW]	The picture is softly focused.

[SATURATION]

[HIGH]	The colors in the picture become vivid.
[LOW]	The colors in the picture become natural.

[NOISE REDUCTION]

[HIGH]	The noise reduction effect is enhanced. Picture resolution may deteriorate slightly.
[LOW]	The noise reduction effect is reduced. You can obtain pictures with higher resolution.



- When you take pictures in dark places, noise may become visible. To avoid picture noise, we recommend setting [NOISE REDUCTION] in [PICT.ADJ.] to [HIGH] or setting the items except [NOISE REDUCTION] to [LOW] to take pictures.

[FLIP ANIM.]

Connecting images to create a motion picture file

PASMC SCN

Press [MENU] to display the [REC] mode menu and select the item to set. (P82)
This camera allows you to create motion picture files up to 20 seconds long by connecting images recorded in flip animation mode.

Example:

When capturing images of the subject in sequence moving the camera little by little and aligning the images, the subject looks as if it is moving.



- You can play back created flip animations with the same method used to play back motion pictures. (P81)

1 Press ▲/▼ to select [FLIP ANIM.] and then press ►.

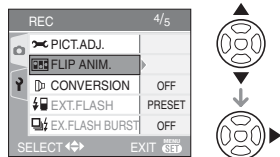

2 Select [PICTURE CAPTURE] and then press ►.

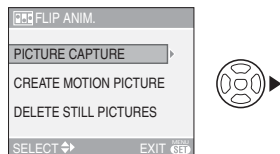

- The picture size is 320×240 pixels.

3 Press the shutter button and capture the images one frame at a time.

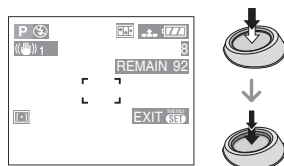

- You can check the recorded image with ▼ and the previous or following image with ◀/▶.
- Delete unnecessary images with the [trash] button.
- You can record up to 100 pictures. The number of recordable pictures displayed is an approximation.

- 4** Press [MENU/SET], press ▲/▼ to select [CREATE MOTION PICTURE] and then press ►.

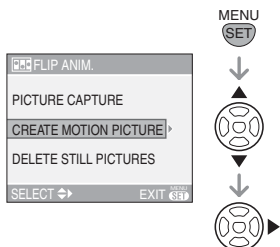

- 5** Select [FRAME RATE] and then press ►.

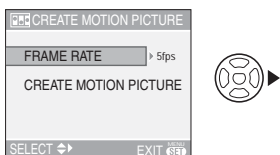

- 6** Press ▲/▼ to select [5fps] or [10fps] and then press [MENU/SET].

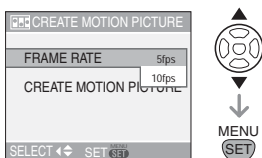

[5fps]	5 frames/sec.
[10fps]	10 frames/sec. (The motion pictures become smoother.)

- 7** Press ▼ to select [CREATE MOTION PICTURE], press ► and then create a flip animation.

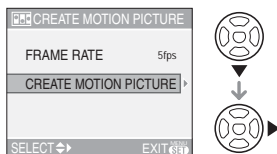

- The file number appears after creating a flip animation.
- Press [MENU/SET] three times to close the menu after creating the flip animation.

■ Deleting all still images used to create flip animation

When selecting [DELETE STILL PICTURES] in [FLIP ANIM.] menu, a confirmation screen appears. Select [YES] with ▲ and then press [MENU/SET].



- You cannot use the direction detection function, continuous mode, auto bracket and [AUDIO REC.].
- The images in each frame do not appear in normal review. (P39)
- If you execute [CREATE MOTION PICTURE], flip animation is made from all pictures recorded for flip animation. Delete unnecessary pictures.
- Audio cannot be recorded.
- You cannot record audio using the audio dubbing. (P108)
- Playback may not be possible on other equipment. You may also hear noise during playback on other equipment which does not have a mute function.

[CONVERSION] Using an optional lens attachment



Press [MENU] to display the [REC] mode menu and select the item to set. (P82)
 A tele conversion lens (optional) allows you to record even more close-up pictures.
 A wide conversion lens (optional) allows you to record even wider angle pictures.
 A close-up lens (optional) allows you to take close-up pictures of a small subject.

1 Remove the lens cap.

2 Attach the conversion lens or the close-up lens.

- A conversion lens cannot be used together with a filter.

Always detach a filter before attaching a conversion lens.

- Rotate the lens slowly and carefully.

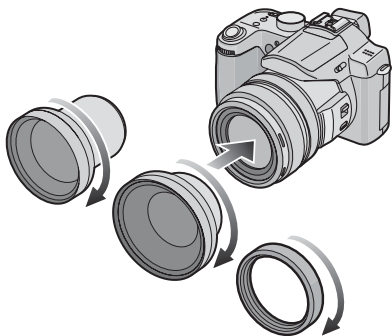

3 Turn the camera on, press ▲/▼ to select [CONVERSION] and then press ►.

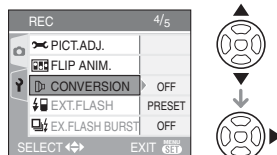

4 Press ▲/▼ to set to [OFF], [Tele], [Wide] or [Close-up] and then press [MENU/SET].

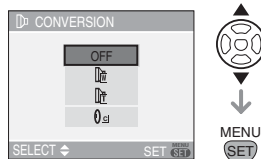

- [OFF]:
When you do not attach a conversion lens.
- [Tele]:
When you attach a wide conversion lens.
- [Wide]:
When you attach a tele conversion lens.
- [Close-up]:
When you attach a close-up lens
- Press the shutter button halfway or press [MENU/SET] to close the menu after finishing the setting.

5 Rotate the zoom ring to Tele or Wide.

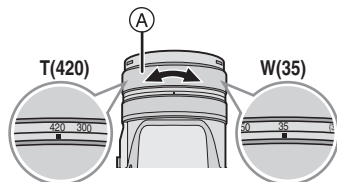
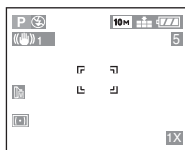

Ⓐ: Zoom ring

- Always set to Tele when using a tele conversion lens and to Wide when using a wide conversion lens. The conversion icon ([T]) or ([W]) changes from red (flashing) to white.
- When using a conversion lens, ensure the conversion icon is white when taking pictures. If pictures are taken when it is flashing, performance will not be up to specification.

■ Recordable range when using a conversion lens

When attaching a tele conversion lens

	Wide	Tele
Normal	—	5.4 m (18 feet) to ∞
Macro	—	5.4 m (18 feet) to ∞

When attaching a wide conversion lens

	Wide	Tele
Normal	15 cm (0.5 feet) to ∞	—
Macro	15 cm (0.5 feet) to ∞	—

When attaching a close-up lens

	Wide	Tele
Normal	20 cm (0.7 feet) to 50 cm (1.7 feet)	40 cm (1.3 feet) to 50 cm (1.7 feet)
Macro	5 cm (0.17 feet) to 50 cm (1.7 feet)	40 cm (1.3 feet) to 50 cm (1.7 feet)

	Indication	Actual magnification
Tele conversion lens	12×	20.4×*
Wide conversion lens	1×	0.7×

- * The actual magnification when using the digital zoom (P38) and the extended optical zoom (P37) is 1.7× the zoom magnification displayed when set to Tele.

- The full range of the zoom can be used when using a close-up lens.



- Digital zoom cannot be used when using a wide conversion lens.
- When there is dirt (water, oil, and fingerprints, etc.) on the surface of the lens, the image may be affected. Lightly wipe the surface of the lens with a soft, dry cloth before and after taking pictures.
- Ensure that [CONVERSION] is set to [OFF] when not using a conversion or close up lens.
- When using a conversion or close-up lens:
 - If you set [CONVERSION] to [OFF], the performance of a conversion lens or a close-up lens will not be optimal.
- When using a tele conversion lens:
 - We recommend using a tripod.
 - The stabilizer function may not work sufficiently.
 - The focus indication may light up due to the jitter even if the subject is not focused.
 - The time required for focusing may become longer than usual.
- If you set [CONVERSION] to [1.4x], [2x] or [3x], you cannot use the built-in flash or AF assist lamp. (P91)
- Read the operating instructions of the conversion lens for details.

[EXT.FLASH] Using an optional flash

P A S M C SCN A

Press [MENU] to display the [REC] mode menu and select the item to set. (P82)
After attaching the external flash, the effective range will be increased when compared to the camera's built-in flash.

■ Using a dedicated flash

1 Attach the dedicated flash to the hot shoe (A) and then turn on the camera and the dedicated flash.

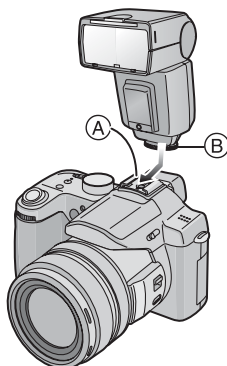



- Be sure to firmly secure the dedicated flash with the lock ring (B).

2 Press [FLASH].

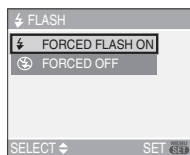
3 Press / to switch the flash settings and then press [MENU/SET].



- What screen will be displayed here depends on the flash mode setting of the external flash unit

Icon	Setting
	External flash Forced ON
	External flash Forced OFF



- When the flash mode of a dedicated flash is set to [TTL AUTO], various different flash settings can be selected to suit the recording mode. For the flash settings that can be selected, refer to P49.
- When the flash mode of a dedicated flash is set to [TTL AUTO] or [AUTO], the flash output can be adjusted by the camera. For details, refer to the operating instructions of the dedicated flash.

- When using an external flash which does not come with functions to communicate with the camera

1 Press ▲/▼ to select [PRESET] or [MANUAL] and then press [MENU/SET].

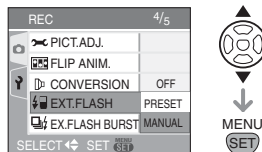

- [PRESET]
 - When setting to [PRESET] and attaching the extra flash, the aperture value and the ISO sensitivity are respectively set to [F4] and [ISO100] on the camera regardless of the recording mode. Set the extra flash to [AUTO] and set the same value as the settings on the camera.
 - We recommend setting to [PRESET] for normal use.
- [MANUAL]
 - You can set the aperture value, the shutter speed and the ISO sensitivity on the camera even when attaching the external flash.
 - Set to the Aperture-priority AE mode or the Manual exposure mode on the camera and then set the same aperture value and ISO sensitivity on the external flash. (The exposure cannot be compensated adequately due to the change on the aperture value in the shutter-priority AE mode and the external flash cannot control the light adequately in AE mode because the aperture value cannot be fixed.)
 - It is necessary to set the exposure on the external flash. If you want to use the external flash in auto mode, use an external flash that allows you to set the aperture value and the ISO sensitivity to match the settings on the camera.



- You can set the aperture value, the shutter speed and the ISO sensitivity on the camera even when attaching the external flash.
- Some commercial external flashes have synchro terminals with high-voltage or reversed polarity. Using such extra flashes may cause a malfunction or the camera may not operate normally.
- **If you use commercially available external flashes with communication functions other than the dedicated one, they may not operate normally or they may be damaged. Do not use them.**
- **Even if the external flash is turned off, the camera may enter the external flash mode when the external flash is attached. When you are not using the external flash, detach it or set it to Forced OFF.**
- When attaching the external flash, the built-in flash cannot be activated.
- Do not open the built-in flash when an external flash is attached.
- When attaching the external flash, the camera will become unstable.
- Detach the external flash when carrying the camera.
- When attaching the external flash, do not hold only the external flash because it may detach from the camera.
- If you use the external flash when the white balance is set to [WB] finely adjust the white balance depending on the picture quality. (P85)
- If you take pictures close to the subject in Wide, the vignetting effect may appear on the bottom of the recorded picture.
- Read the operating instructions of the external flash for details.



[EX.FLASH BURST] Taking pictures in continuous mode while firing the flash



Press [MENU] to display the [REC] mode menu and select the item to set. (P82)
This mode allows you to take multiple pictures at one time when the external flash is attached.

- Set [EX.FLASH BURST] to [ON].
- Press the Single/Continuous Mode Button to switch the continuous mode setting.
- You can take up to 3 pictures by keeping the shutter button pressed down.

■ Number of pictures recorded in continuous mode

	Frequency (pictures/ second)	Number of recordable pictures (pictures)
	2	max. 3
	1	
	Approx. 1	



- Depending on the external flash you use or the recording conditions, you cannot take pictures in this mode or the amount of light may become insufficient for the second or subsequent pictures.



[CLOCK SET] Set the date, time and display



Press [MENU] to display the [REC] mode menu and select the item to set. (P82)
Change date and time. (P26)

Using the [PLAY] mode menu



You can use various functions in playback mode to rotate pictures, set protection for them etc.

• Refer to P102 to 111 for each menu item.

1 Press [MENU/SET].

2 Press ▲/▼ to select the menu item and then press ►.

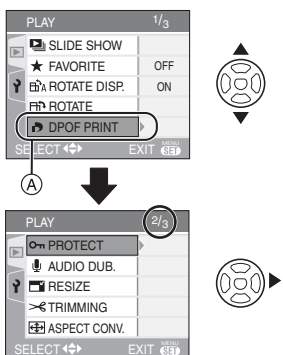

- Press ▼ at (A) to switch to the next menu screen.
- After performing steps 1 and 2, refer to the description of the menu item in the operating instructions and then set it.

■ About the menu screen items

- There are 3 menu screens (1/3, 2/3 and 3/3).
- You can switch menu screens from any menu item by rotating the front dial.

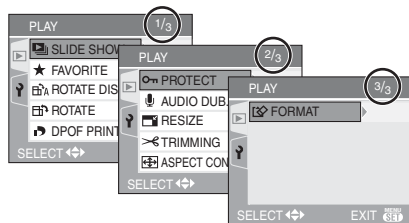

[SLIDE SHOW]

Playing back pictures in order for a fixed duration

Press [MENU] to display the [PLAY] mode menu and select the item to set. (P102)
This is recommended when playing back pictures on a TV screen. You can skip unwanted pictures if [FAVORITE] (P103) has been set.

1 Press ▲/▼ to select [ALL] or [★] and then press [MENU/SET].

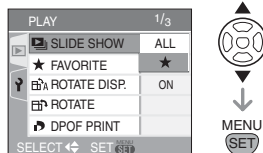

[ALL]	Displays all pictures.
[★]	Displays only those pictures that have been set as favorites (P103).

- The screen shown in step 1 appears when [FAVORITE] is set to [ON]. When [FAVORITE] is set to [OFF], perform step 2 onwards.
- If none of the pictures have [★] displayed, you cannot select [★] even if [FAVORITE] is set to [ON].

2 Press ▲ to select [START] and then press [MENU/SET].

(Screen when [ALL] is selected)

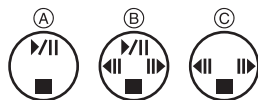
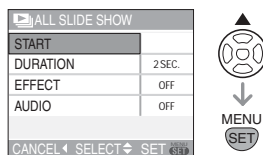

- The cursor displayed during a slide show (A) or while a slide show is paused (B) or during [MANUAL] slide show (C) is the same as ▲/▼/◀/▶.
- Press ▲ to pause the slide show. Press ▲ again to cancel pause.
- Press ◀/▶ while paused to display the previous or next picture. (However, the selected effect is disabled.)

3 Press ▼ to finish.

■ Setting the audio, duration and effect

Select [DURATION], [EFFECT] or [AUDIO] on the screen shown in step 2 and set.

[DURATION]	<p>Can be set to [1SEC.], [2SEC.], [3SEC.], [5SEC.] or [MANUAL] (manual playback).</p> <ul style="list-style-type: none"> • The playback durations are approximations only. They differ depending on the pictures which are played back.
[EFFECT]	<p>A slide show effect can be selected.</p> <p>[OFF]: No effect</p> <p>[]: Pictures are played back in a slide show.</p> <p>[]: New pictures appear from behind the current pictures and replace them.</p> <p>[]: New pictures gradually fill the screen from the center.</p> <p>[MIX]: An effect is selected at random.</p> <ul style="list-style-type: none"> • If you set [DURATION] to [MANUAL] the settings in [EFFECT] are disabled.
[AUDIO]	<p>If set to [ON], the audio of the pictures with audio is played back.</p>

- You can only select [MANUAL] when [★] has been selected in step 1.
- Press ◀/▶ to display the previous or next picture when [MANUAL] is selected.



- If you set [AUDIO] to [ON] and then play back a picture with audio, the next picture will be displayed after the audio has finished.
- You cannot play back motion pictures and use power save in a slide show. (However, the setting for power save mode is fixed to [10MIN.] while pausing a slide show or playing back a manual slide show.)

★ [FAVORITE] Setting your favorite pictures

Press [MENU] to display the [PLAY] mode menu and select the item to set. (P102)
You can do the following if a mark has been added to pictures and they have been set as favorites.

- Delete all the pictures not set as favorites. ([ALL DELETE EXCEPT ★]) (P41)
- Play back the pictures set as favorites only as a slide show. (P102)

1 Press ▼ to select [ON] and then press [MENU/SET].

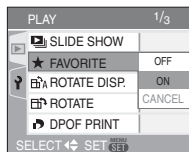

- You cannot set pictures as favorites if [FAVORITE] is set to [OFF]. Also the favorites icon [★] will not appear when [FAVORITE] is set to [OFF] even if it was previously set to [ON].
- You cannot select [CANCEL] if none of the pictures have [★] displayed.

2 Press [MENU/SET] to close the menu.

3 Press ◀/▶ to select the picture then press ▲.



- Repeat the above procedure.
- If ▲ is pressed while the [★] favorites icon (A) is displayed, [★] is cleared, and the favorites setting is canceled.
- You can set up to 999 pictures as favorites.

■ Deleting all favorites

- 1 Select [CANCEL] on the screen shown in step 1 and then press [MENU/SET].
- 2 Press ▲ to select [YES] and then press [MENU/SET].
- 3 Press [MENU/SET] to close the menu.



- When printing pictures at a photo printing store, [ALL DELETE EXCEPT ★] (P41) is useful so only the pictures you want to be printed remain on the card.
- You may not be able to set pictures taken with other equipment as favorites.

▶ [ROTATE DISP.]/[ROTATE]

To display the picture rotated

Press [MENU/SET] to display the [PLAY] mode menu and select the item to set. (P102) This mode allows you to automatically display pictures vertically if they were recorded holding the camera vertically or rotate pictures manually in 90° steps.

■ Rotate display
(The picture is automatically rotated and displayed.)

1 Press ▼ to select [ON] and then press [MENU/SET].

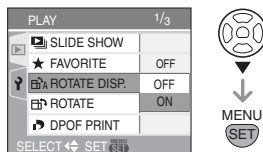

- The pictures are displayed without being rotated when you select [OFF].
- Refer to P40 for information about how to play back pictures.

2 Press [MENU/SET] to close the menu.

■ Rotate
(The picture is rotated manually.)

1 Press ◀/▶ to select the picture and then press ▼.

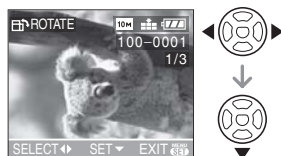

- The [ROTATE] function is disabled when [ROTATE DISP.] is set to [OFF].
- Motion pictures and protected pictures cannot be rotated.

2 Press ▲/▼ to select the direction to rotate the picture and then press [MENU/SET].



	The picture rotates clockwise in steps of 90°.
	The picture rotates counter-clockwise in steps of 90°.

3 Press [MENU/SET] twice to close the menu.

■ Example

When rotating clockwise (↻)

Original picture

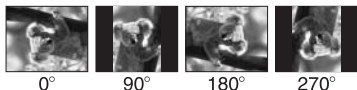

- When [ROTATE DISP.] is set to [ON], pictures recorded holding the camera vertically are played back vertically (rotated).
- If you take pictures when aiming the camera up or down, it may not be possible to display the pictures vertically. (P34)
- The picture may be slightly blurred when the camera is connected to the TV with the AV cable (supplied) and played back vertically.
- When you play back pictures on a PC, they cannot be displayed in the rotated direction unless the OS or software is compatible with Exif. Exif is a file format for still pictures which allows recording information etc. to be added.

- Rotated pictures are displayed without being rotated when they are played back in multi playback.
- It may not be possible to rotate pictures that have been recorded with other equipment.

[DPOF PRINT]

Setting the picture to print and the number of prints

Press [] to display the [PLAY] mode menu and select the item to set. (P102) DPOF [Digital Print Order Format] is a system that allows the user to select which pictures to print, how many copies of each picture to print and whether or not to print the recording date on the pictures when using a DPOF compatible photo printer or photo printing store. For details, ask at your photo printing store.

Press ▲/▼ to select [SINGLE], [MULTI] or [CANCEL] and then press [MENU/SET].

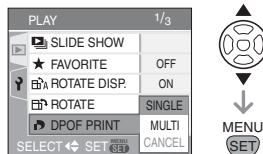

- You cannot select [CANCEL] if there are no prints that have been set in the DPOF print settings.

■ Single setting

1 Press **◀/▶** to select the picture to print and then press **▲/▼** to set the number of prints.

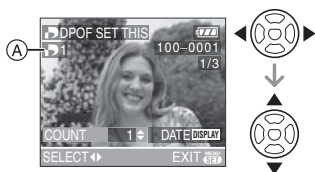



- The number of prints icon [] (A) appears.
- The number of prints can be set from 0 to 999. The DPOF print setting is canceled when the number of prints is set to [0].

2 Press **[MENU/SET]** twice to close the menu.

■ Multi setting

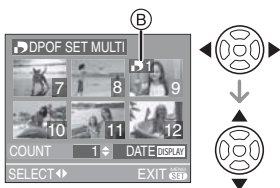
1 Press **◀/▶** to select the picture to print then press **▲/▼** to set the number of prints.



- The number of prints icon [] (B) appears.
- Repeat the above procedure. (You cannot set all the pictures at one time.)
- The number of prints can be set from 0 to 999. The DPOF print setting is canceled when the number of prints is set to [0].

2 Press **[MENU/SET]** twice to close the menu.

■ To cancel all settings

1 Press **▲** to select **[YES]** and then press **[MENU/SET]**.

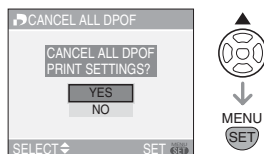

2 Press **[MENU/SET]** to close the menu.

■ To print the date

After setting the number of prints, set/cancel printing with the recording date by pressing **[DISPLAY]**.

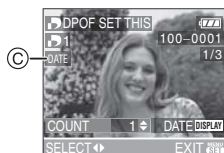

- The date print icon [] (C) appears.
- When you go to a photo printing store for digital printing, be sure to order the printing of the date additionally if required.
- Depending on the photo printing store or the printer, the date may not be printed even if you set to print the date. For further information, ask at your photo printing store or refer to the operating instructions for the printer.





- DPOF is an abbreviation of “Digital Print Order Format”. This feature allows you to write print information to media and then use the information on a DPOF-compliant system.

- DPOF print setting is a convenient function when printing pictures with a printer that supports PictBridge. The date printing setting on the printer may take priority over the date printing setting on the camera. Check the date printing setting on the printer also. (P115)
- It is necessary to delete all previous DPOF print information made on other equipment when setting DPOF print on the camera.
- If the file is not based on the DCF standard, the DPOF print setting cannot be set. DCF is an abbreviation of "Design rule for Camera File system".

[PROTECT]

 Preventing accidental erasure of pictures

Press [] to display the [PLAY] mode menu and select the item to set. (P102)
You can set protection for pictures you do not want to be deleted by mistake.

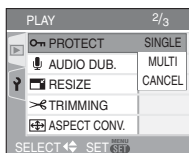

Press / to select [SINGLE], [MULTI] or [CANCEL] and then press [MENU/SET].



■ Single setting

1 Press / to select the picture and then press  to set/cancel.



[SET]	The protect icon [] (A) appears.
[CANCEL]	The protect icon [] (A) disappears.

2 Press [MENU/SET] twice to close the menu.

■ Multi setting/To cancel all settings

Perform the same operation as in "DPOF PRINT Setting the picture to print and the number of prints". (P105 to 107)



- If you press [MENU/SET] while canceling protection, the canceling will stop halfway.
- The protect setting may not be effective on other equipment.
- If you want to delete protected pictures, cancel their protection.
- Even if you protect pictures on a card, they will be deleted if the card is formatted. (P111)
- Even if you do not protect pictures on an SD Memory Card or SDHC Memory Card, they cannot be deleted when the card's write protect switch (B) is set to [LOCK].



- The following functions cannot be used with protected pictures.
 - [ROTATE]
 - [AUDIO DUB.]

**[AUDIO DUB.]****Adding audio after taking pictures**

Press [MENU] to display the [PLAY] mode menu and select the item to set. (P102)
You can add the audio after taking a picture.

1 Press ◀/▶ to select the picture and then press ▼ to start audio recording.



- The message [OVERWRITE AUDIO DATA?] screen appears when audio has already been recorded. Press ▲ to select [YES] and then press [MENU/SET] to start audio recording. (The original audio is overwritten.)
- Audio dubbing cannot be used with the following pictures.
 - Motion pictures
 - Protected pictures
 - Pictures recorded after setting the quality to [RAW]

2 Press ▼ to stop recording.

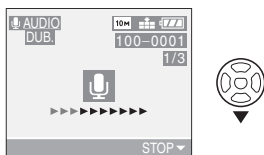

- The audio recording stops automatically if ▼ is not pressed after about 10 seconds.

3 Press [MENU/SET] twice to close the menu.

**[RESIZE]****Making the picture smaller**

Press [MENU] to display the [PLAY] mode menu and select the item to set. (P102)
This function is useful if you want to reduce the file size of a picture to attach it to an e-mail or upload it to a website.

1 Press ◀/▶ to select the picture and then press ▼.

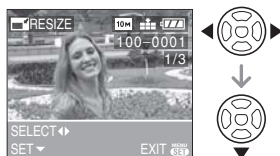

- The following pictures cannot be resized.
 - Pictures recorded in [2.5M] (2.5M EZ) (When the aspect ratio setting is [3:2].)
 - Pictures recorded in [2M] (2M EZ) (When the aspect ratio setting is [16:9].)
 - Pictures recorded after setting the quality to [RAW]
 - Motion pictures
 - Pictures with audio
 - Flip animation

2 Press **◀/▶** to select the size and then press **▼**.



- Sizes smaller than the recorded picture are displayed.

– [8M]/[5M]/[3M]/[2M]/[1M]/[0.3M]
(When the aspect ratio setting is [4:3].)

– [7M]/[4.5M]/[2.5M]
(When the aspect ratio setting is [3:2].)

– [5.5M]/[2M]
(When the aspect ratio setting is [16:9].)

- The message [DELETE ORIGINAL PICTURE?] appears.

3 Press **▲/▼** to select [YES] or [NO] and then press [MENU/SET].



- The picture is overwritten when you select [YES]. Resized pictures cannot be restored when they are overwritten.
- A resized picture is newly created when you select [NO].
- If the original picture is protected, you cannot overwrite it. Select [NO] and newly create a resized picture.

4 Press [MENU/SET] twice to close the menu.



- It may not be possible to resize pictures recorded with other equipment.

[TRIMMING] Enlarging a picture and trimming it

Press [MENU/SET] to display the [PLAY] mode menu and select the item to set. (P102)
You can enlarge and then clip the important part of the recorded picture.

1 Press **◀/▶** to select the picture and then press **▼**.



- The following pictures cannot be trimmed.
 - Pictures recorded after setting the quality to [RAW]
 - Motion pictures
 - Pictures with audio
 - Flip animation

2 Rotate the front dial to enlarge or decrease the picture.



3 Press **▲/▼/◀/▶** to move the position of the part to be trimmed.

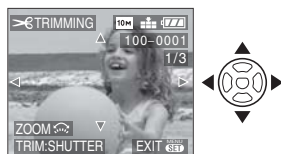

4 Press shutter button.

- The message [DELETE ORIGINAL PICTURE?] appears.

5 Press ▲/▼ to select [YES] or [NO] and then press [MENU/SET].



- The picture is overwritten when you select [YES]. The trimmed pictures cannot be restored when they are overwritten.
- A trimmed picture is newly created when you select [NO].
- When the original picture is protected, you cannot overwrite it. Select [NO] and newly create a trimmed picture.

6 Press [MENU/SET] twice to close the menu.



- Depending on the cut size, the picture size of the trimmed picture may become smaller than that of the original picture.
- The picture quality of the trimmed picture will deteriorate.
- It may not be possible to trim pictures recorded with other equipment.

[ASPECT CONV.]



Changing the aspect ratio of a 16:9 picture

Press [MENU] to display the [PLAY] mode menu and select the item to set. (P102)
You can convert pictures taken with a [16:9] aspect ratio to a [3:2] or a [4:3] aspect ratio.

1 Press ▲/▼ to select [3:2] or [4:3] and then press [MENU/SET].

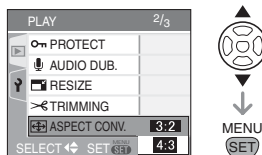

- Only pictures taken with a [16:9] aspect ratio can be converted.
- You may not be able to convert pictures taken on other equipment.

2 Press ◀/▶ to select a picture and then press ▼.



- If you select and set a picture with an aspect ratio other than [16:9], the message [CANNOT BE SET ON THIS PICTURE] is displayed on the screen.

3 Press ◀/▶ to determine the horizontal position and press the shutter button to set.



- Use ▲/▼ to set the frame position for pictures rotated vertically.
- The message [DELETE ORIGINAL PICTURE?] appears.

4 Press ▲/▼ to select [YES] or [NO] and then press [MENU/SET].

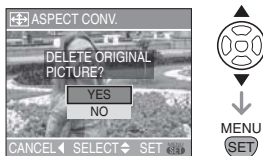

- The picture is overwritten when you select [YES]. If you convert the aspect ratio of a picture and then overwrite it, you cannot restore it.
- A picture with the converted aspect ratio is newly created when you select [NO].
- When the original picture is protected, you cannot overwrite it. Select [NO] and newly create a picture with the converted aspect ratio.

5 Press [MENU/SET] twice to close the menu.



- After converting the aspect ratio, the picture size may become larger than that of the original picture.
- The following pictures cannot be converted.
 - Pictures with audio
 - Motion pictures
 - Pictures recorded after setting the quality to [RAW]
- Files that do not conform to the DCF standard cannot be converted. DCF is an abbreviation of [Design rule for Camera File system].

[FORMAT] Initializing the card

Press [MENU/SET] to display the [PLAY] mode menu and select the item to set. (P102) It is not usually necessary to format a card. Format it when the message [MEMORY CARD ERROR] appears.

Press ▲ to select [YES] and then press [MENU/SET].

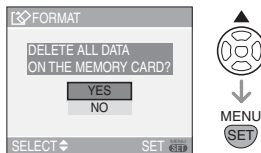

- Formatting irretrievably deletes all the data including any protected pictures. Check the data carefully before formatting.
- If the card has been formatted on a PC or other equipment, format it on the camera again.
- Use a battery with sufficient battery power (P16) or the AC adaptor (ACA-DC5; optional) when formatting.
- Do not turn the camera off during formatting.
- You cannot format an SD Memory Card or SDHC Memory Card when the card's write protect switch (A) is set to [LOCK].



- If the card cannot be formatted, consult your nearest servicenter.

Connecting to a PC



You can transfer recorded pictures to a PC by connecting the camera and the PC. The software [Photoshop Elements 4.0 (Win)/3.0 (Mac)] in the CD-ROM (supplied) allows you to easily transfer pictures recorded with the camera to a PC, print them and send them by e-mail.

If you use "Windows 98/98SE", install the USB driver and then connect it to the computer.

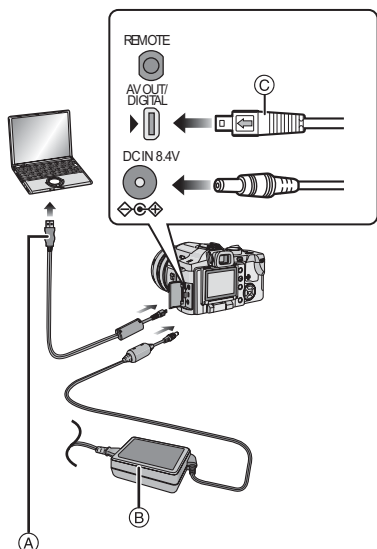

(A) USB connection cable (supplied)

(B) AC adaptor (ACA-DC5; optional)

- Use a battery with sufficient battery power or the AC adaptor (ACA-DC5; optional).
- Turn the camera off before inserting or removing the cable for the AC adaptor (ACA-DC5; optional).

1 Turn on the camera and the PC.

2 Connect the camera to a PC via the USB connection cable (A) (supplied).

- Connect the USB connection cable with the [←] mark facing the [→] mark on the [DIGITAL] socket.
- Hold the USB connection cable at (C) and insert straight in or take straight out. (If you forcibly insert the USB connection cable at a slant or upside down you can deform the connection terminals and damage the camera or the connected equipment.)

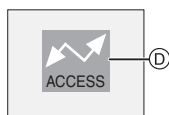

(D): This message appears during data transfer.

3 Press ▲ to select [PC] and then press [MENU/SET].

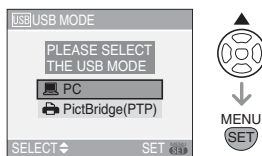

- If you set [USB MODE] in the [SETUP] menu to [PC] in advance, it is not necessary to set this every time you connect to a PC. (P30)
- If you set [USB MODE] to [PictBridge (PTP)] and then connect the camera to the PC, messages may appear on the screen of the PC. Select [Cancel] to close the messages and disconnect the camera from the PC. Set [USB MODE] to [PC] again.

[Windows]

The drive appears in the [My Computer] folder.

- If you are connecting the camera to a PC for the first time, the required driver is installed automatically so that the camera can be recognized by “Windows Plug and Play”. The drive then appears on the [My Computer] folder.

[Macintosh]

The drive is displayed on the screen.

- The drive is displayed as [LEICA] when you connect the camera with no card inserted.
- The drive is displayed as [NO_NAME] or [Untitled] when you connect the camera with a card inserted.

■ About motion picture playback on a PC

Use the software “QuickTime” (for Windows 2000/XP) in the CD-ROM (supplied) to play back motion pictures recorded on this camera on a PC.

- If you use “Windows 98/98SE/Me”, download “QuickTime6.5.2 for PC” from the following site, and install it.
<http://www.apple.com/support/quicktime/>
- This software is installed as standard on a “Macintosh OS”.

■ Folder Composition

Folders are displayed as shown in the following illustration.

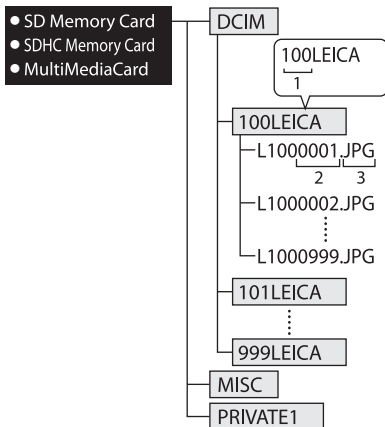

- 1 Folder number
- 2 File number
- 3 JPG: pictures
MOV: motion pictures
RAW: pictures in RAW files

The items in each folder are as follows.

[DCIM]	Folders from [100LEICA] to [999LEICA]
[100LEICA] to [999LEICA]	Pictures/motion pictures Pictures in RAW files
[MISC]	Files on which the DPOF print settings are recorded
[PRIVATE1]	Pictures recorded in flip animation function

- The data for up to 999 pictures recorded by the camera can be included in 1 folder. If the number of pictures exceeds 999, another folder is created.
- To reset the file number or the folder number, select [NO.RESET] in the [SETUP] menu. (P29)

■ **Conditions under which a different folder number is used**

In the following cases, the picture is not recorded in the same folder as the previously recorded picture. It is recorded in a folder with a new number.

- 1 When the folder just recorded to contains a picture file with the number 999 in it (example: L1000999.JPG).
- 2 When the card just recorded to contains, for example, a folder with the number 100 [100LEICA] in it and that card is removed and replaced with a card that has a folder with the number 100 in it recorded by a camera from a different maker (100XXXXX, with XXXXX being the name of the maker) and then a picture is recorded.

- 3 When recording after selecting [NO.RESET] (P29) from the [SETUP] menu. (Pictures will be recorded to a new folder with a number sequential to the folder recorded to immediately before. By using [NO.RESET] on a card that does not contain folders or pictures, such as one just formatted, the folder number can be reset to 100.)

■ **PictBridge (PTP) setting**

Even if you set [USB MODE] to [PictBridge (PTP)], you can connect to your PC if the OS is "Windows XP" or "Mac OS X".

- Pictures can only be read on the camera. They cannot be written to a card or deleted.
- When there are 1000 or more pictures on a card, the pictures may not be imported.



- Do not use any other USB connection cables except the supplied one.
- Do not disconnect the USB connection cable while [ACCESS] is displayed.
- When there are many pictures on the card, it may take some time to transfer them.
- You may not be able to play back motion pictures on the card correctly when the camera is connected to a PC. Import the motion picture files to the PC and then play them back.
- If battery power is exhausted while the camera and the PC are communicating, the recorded data may be damaged. When you connect the camera to the PC, use a battery with sufficient battery power (P16) or the AC adaptor (ACA-DC5; optional).
- If the remaining battery power becomes low while the camera and the PC are communicating, the power indicator blinks and the alarm beeps. In this case, stop the communication at once on the PC.
- **When connecting the camera to a "Windows 2000" OS PC with the USB connection cable, do not replace the card while the camera and the PC are connected. The information on the card may be damaged. Disconnect the USB connection cable before replacing the card.**
- Pictures edited or rotated with a PC are not displayed in playback mode (P40), multi playback (P78) and calendar playback (P79).
- Read the operating instructions for the PC.

Printing the Pictures



By connecting the camera directly to a printer supporting PictBridge via the USB connection cable (supplied), you can select the pictures to print and start printing on the camera's screen.

Set print settings such as the print quality on the printer beforehand. (Read the printer operating instructions.)

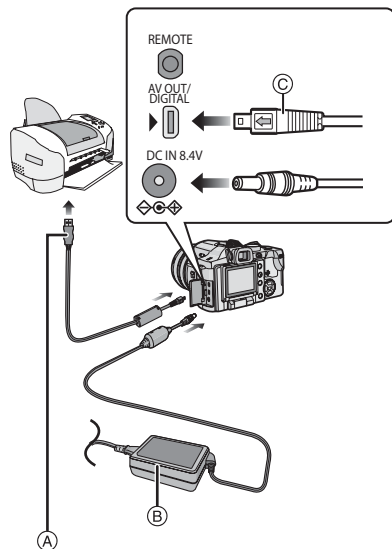

(A): USB connection cable (supplied)

(B): AC adaptor (ACA-DC5; optional)

- It may take time to print some pictures. Use a battery with sufficient battery power (P16) or the AC adaptor (ACA-DC5; optional) when you connect to a printer.
- Turn the camera off before inserting or removing the cable for the AC adaptor (ACA-DC5; optional).

1 Turn on the camera and the printer.

2 Connect the camera to a printer via the USB connection cable (A) (supplied).

- Connect the USB connection cable with the [◀] mark facing the [▶] mark on the [DIGITAL] socket.
- Hold the USB connection cable at (C) and insert straight in or take straight out.

3 Press ▼ to select [PictBridge (PTP)] and then press [MENU/SET].

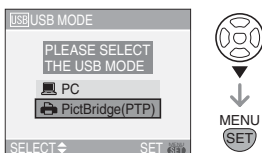

- If you set [USB MODE] in the [SETUP] menu to [PictBridge (PTP)] in advance, it is not necessary to set this every time you connect to a printer. (P30)



- Do not use any other USB connection cables except the supplied one.
- To find out more about PictBridge compliant printers, contact your local dealer.

Single picture

1 Press ▲ to select [SINGLE PICTURE] and then press [MENU/SET].



2 Press ◀/▶ to select the picture and then press ▼.

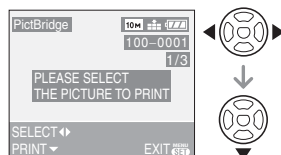

- The message disappears in about 2 seconds.

3 Press ▲ to select [PRINT START] and then press [MENU/SET].

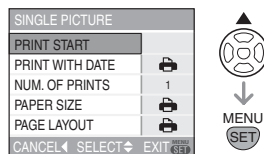

- Press [MENU/SET] to cancel printing.

4 Disconnect the USB connection cable after printing.

Setting date printing, the number of prints, the paper size and the page layout

Select and set each item in step 3.

- Items not supported by the printer are displayed in gray and cannot be selected.

- When you want to print pictures in a paper size or a layout which is not supported by the camera, set [PAPER SIZE] or [PAGE LAYOUT] to [] and then set the paper size or the layout on the printer. (For details, refer to the operating instructions of the printer.)

• [PRINT WITH DATE]

	Settings on the printer are prioritized.
[OFF]	Date is not printed.
[ON]	Date is printed.

- If the printer does not support date printing, the date cannot be printed on the picture.

• [NUM. OF PRINTS]

Set the number of prints.

• [PAPER SIZE]

(Paper sizes that can be set with this unit)





The paper sizes are displayed on pages 1/2 and 2/2. Press ▼ to select.

1/2	
	Settings on the printer are prioritized.
[L/3.5"×5"]	89 mm×127 mm
[2L/5"×7"]	127 mm×178 mm
[POSTCARD]	100 mm×148 mm
[A4]	210 mm×297 mm
2/2*	
[CARD SIZE]	54 mm×85.6 mm
[10×15cm]	100 mm×150 mm
[4"×6"]	101.6 mm×152.4 mm
[8"×10"]	203.2 mm×254 mm
[LETTER]	216 mm×279.4 mm

- *These items cannot be displayed when the printer does not support the paper sizes.

• [PAGE LAYOUT]

(Layouts for printing that can be set with this unit)

	Settings on the printer are prioritized.
	1 picture with no frame on 1 page
	1 picture with a frame on 1 page
	2 pictures on 1 page
	4 pictures on 1 page

- An item cannot be selected if the printer does not support the page layout.

■ DPOF picture

- Set the DPOF print setting on the camera in advance. (P105)

1 Press ▼ to select [DPOF PICTURE] and then press [MENU/SET].

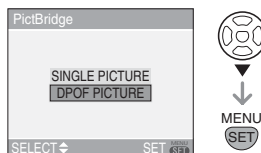

2 Press ▲ to select [PRINT START] and then press [MENU/SET].

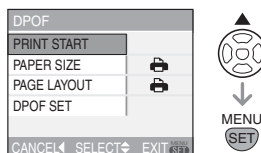

- You cannot select [PRINT START] when the DPOF print setting is not set. Select [DPOF SET] and then set the DPOF print setting. (P105)
- Press [MENU/SET] to cancel printing.

3 Disconnect the USB connection cable after printing.

■ Setting the date printing with the DPOF print in advance

We recommend setting DPOF date printing with [DPOF PRINT] (P106) in advance when the printer supports it. If you select

[DPOF PICTURE], printing starts and the recording date is printed.

■ Layout printing

• When printing a picture several times on 1 sheet of paper

For example, if you want to print a picture 4 times on 1 sheet of paper, set [PAGE LAYOUT] to [] and then set [NUM. OF PRINTS] to 4.

• When printing different pictures on 1 sheet of paper (only in DPOF printing)

For example, if you want to print 4 different pictures on 1 sheet of paper, set [PAGE LAYOUT] to [] and then set [COUNT] in [DPOF PRINT] (P105) to 1 for each of the 4 pictures.



- Do not disconnect the USB connection cable when the cable disconnection warning icon [] is displayed. (Depending on the printer, the icon may not be displayed.)
- If the remaining battery power becomes low while the camera and the printer are connected, the power indicator flashes and the alarm beeps. If this happens during printing, press [MENU/SET] and stop printing at once. If not printing, disconnect the USB connection cable.
- The camera is receiving an error message from the printer when the [] indication lights orange during printing. After finishing printing, make sure there are no problems with the printer.
- If the total number of DPOF prints or the number of DPOF pictures printed is high, pictures may be printed several times. The remaining number of prints indicated may differ from the number set. This is not a malfunction.
- With date printing, the setting on the printer may take priority over the setting on the camera. Check the date print setting on the printer also.
- When the pictures in RAW files are to be printed, the JPEG pictures recorded simultaneously by the camera will be printed. If JPEG pictures do not exit, RAW file pictures cannot be printed.

Playing Back Pictures on a TV Screen



■ Playing back pictures using the AV cable (supplied)

- Set the aspect of the TV on the camera. (P30)
- Turn the camera and the TV off.

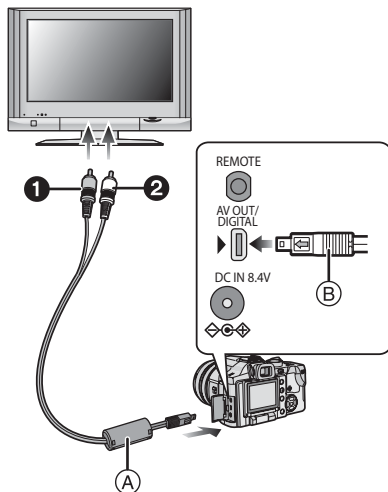

1 Connect the AV cable (A) (supplied) to the [AV OUT] socket on the camera.

- Connect the AV cable with the [←] mark facing the [▶] mark on the [AV OUT] socket.
- Hold the AV cable at (B) and insert straight in or take straight out.

2 Connect the AV cable to the video input and the audio input sockets on the TV.

- ① Yellow: to the video input socket
- ② White: to the audio input socket

3 Turn the TV on and select external input.

4 Turn the camera on.



- Do not use any other AV cables except the supplied one.
- The top and bottom or left and right of the picture may be cut off slightly when it is displayed due to the characteristics of the TV.
- Depending on the screen mode setting of the TV when you connect the camera to a wide-screen TV or a high-definition TV, the picture may be stretched horizontally or vertically and the top and bottom and/or left and right of the picture may be cut off when it is displayed. In this case, change the screen mode setting.
- Audio playback is monaural.
- Read the operating instructions for the TV.
- When you play back a picture vertically, it may be blurry.
- Select [TV ASPECT] to match the aspect of the TV.
- You can view pictures on TVs in other countries (regions) which use the NTSC or PAL system when you set [VIDEO OUT] in the [SETUP] menu. Even if you set [VIDEO OUT] to [PAL], the output signal will still be NTSC in the recording mode.

■ Playing back pictures on a TV with an SD Memory Card slot

Still pictures recorded on an SD Memory Card can be played back on a TV with an SD Memory Card slot.



- You cannot play back an SDHC Memory Card if the TV model does not support it.
- Depending on the TV model, pictures may not be displayed on the full screen.
- Motion pictures cannot be played back. To play back motion pictures, connect the camera to the TV with the AV cable (supplied).
- You may not be able to play back MultiMediaCards.

Using Filters

The optional Uva filter (order no. 18 670) is totally transparent and affects neither color rendition nor exposure, so it can always remain on the lens as protection.

The optional polarizing filter (order no. 18 671) can be utilized

1. to darken blue skies and emphasize the rendition of clouds (by reducing haze), and
2. to reduce or eliminate reflections from all surfaces except metal (especially on water), thereby also leading to more saturated colors.

The effect is controllable by rotating the filter in its mount, but it also depends on the angle of the sun and the time of day. Please take into account that a polarizer reduces the amount of light, therefore resulting in longer exposures which may make it necessary to employ a tripod.

1 Remove the lens cap.

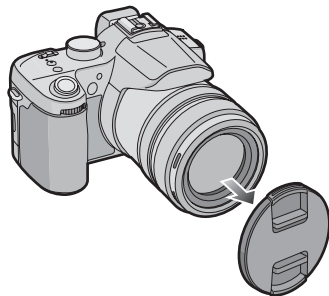

2 Attach the UVa ① or polarizing filter ②.

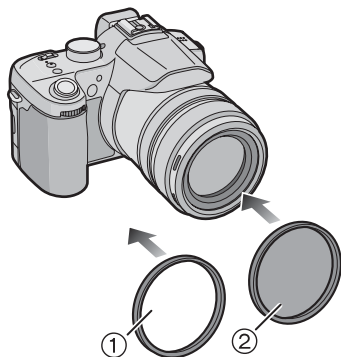

- You cannot attach both filters at the same time.
- If a filter is tightened too much, you may not be able to remove it. Do not tighten it too much.
- When taking pictures with the flash using a filter, vignetting effect may occur.
- If a filter is dropped, it may be destroyed. Be careful not to drop it when attaching it to the camera.
- You can attach the lens hood when a filter is attached.
- Detach a filter before attaching a conversion lens.

Using the Remote Control Unit

If you use the remote control unit (CR-DC1; optional), you can avoid jitter (camera shake) when using a tripod. The remote control unit works similar to the shutter button on the camera.

1 Connect the remote control unit to the [REMOTE] socket on the camera firmly.

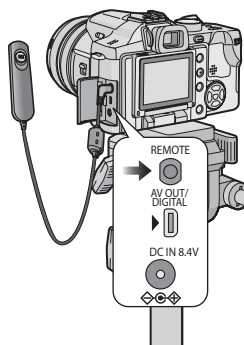

2 Take a picture.

- 1: Press the button lightly to press halfway.

- ②: Press the button fully to take the picture. (Press it as far as it will go.)

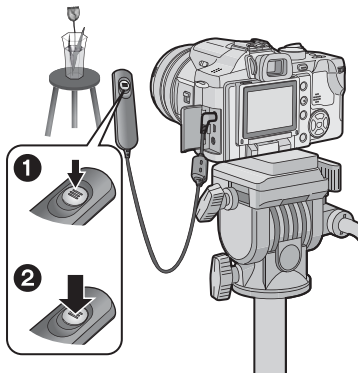

- Bulb exposure (the shutter remains open as long as the shutter button is pressed) is not available with this camera.
- You cannot operate the camera with the remote control unit in the following cases:
 - When the power save mode is canceled
 - When you determine the part to be trimmed (P109)
 - When you determine the aspect ratio conversion (P110)

Cautions for Use

■ Optimal use of the camera

Take care not to drop or knock the unit or put a lot of pressure on it.

- Take care not to drop or knock the bag that you inserted the unit in as it may strongly shock the unit.
- A strong shock may break the lens, screen or outer case and cause the camera to malfunction.

Keep the camera as far away as possible from electromagnetic equipment (such as microwave ovens, TVs, video games etc.).

- If you use the camera on top of or near a TV, the pictures and sound on the camera may be disrupted by electromagnetic wave radiation.
- Do not use the camera near cell phones because doing so may result in noise adversely affecting the pictures and sound.
- Recorded data may be damaged, or pictures may be distorted, by strong magnetic fields created by speakers or large motors.
- Electromagnetic wave radiation generated by microprocessors may adversely affect the camera, disturbing the pictures and sound.
- If the camera is adversely affected by electromagnetic equipment and stops functioning properly, turn the camera off and remove the battery or disconnect AC adaptor (ACA-DC5; optional). Then reinsert the battery or reconnect AC adaptor and turn the camera on.

Do not use the camera near radio transmitters or high-voltage lines.

- If you record near radio transmitters or high-voltage lines, the recorded pictures and sound may be adversely affected.

Always use the supplied cords and cables. If you use optional accessories, use the cords and the cables supplied with them.

Do not extend the cords or the cables.

Do not spray the camera with insecticides or volatile chemicals.

- If the camera is sprayed with such chemicals, the body of the camera may be damaged and the surface finish may peel off.
- Do not keep rubber or plastic products in contact with the camera for a long period of time.

Do not use benzene, thinner or alcohol for cleaning the camera.

- Before cleaning the camera, remove the battery or disconnect the AC adaptor (ACA-DC5; optional) from the electrical outlet.
- The body of the camera may be damaged and the surface finish may peel off.
- If you use a chemically treated cloth, read the instructions that come with the cloth.
- Wipe the dust or fingerprints with a soft, dry cloth.
- Wipe off any dirt or dust on the zoom ring or the focus ring with a dry dust cloth.
- Do not use a kitchen detergent or a chemically treated cloth.
- If rain water or other drops of water splash onto the camera, use a dry cloth to wipe the camera body carefully.

■ Card

Do not leave the card where the temperature is high, where electromagnetic waves or static electricity are easily generated or exposed to direct sunlight.

Do not bend or drop the card.

- The card may be damaged or the recorded content may be damaged or deleted.
- Put the card in the card case or the storage bag after use and when storing or carrying the card.

- Do not allow dirt, dust or water to get into the terminals on the back of the card and do not touch the terminals with your fingers.

■ Battery

The battery is a rechargeable lithium ion battery. Its ability to generate power comes from the chemical reaction that takes place inside it. This reaction is susceptible to the surrounding temperature and humidity. If the temperature is too high or too low, the operating time of the battery will become shorter.

If you drop the battery accidentally, check to see if the body of the battery and the terminals are damaged.

- Inserting a damaged battery in the camera will damage the camera.

Bring charged spare batteries when going out.

- Be aware that the operating time of the battery becomes shorter in low temperature conditions such as at a ski resort.
- When you travel, do not forget to bring the battery charger (supplied) so that you can charge the battery in the country that you are travelling in.

Dispose of unusable battery.

- The batteries has a limited life.
- Do not throw batteries into fire because it may cause an explosion.
- The unusable batteries should be discarded in accordance with battery recycling laws.

Do not allow battery terminals to come into contact with metal objects (such as necklaces, hairpins etc.).

- This can cause short circuiting or heat generation and you may be badly burned if you touch a battery.

■ Charger

- If you use the battery charger near a radio, the radio reception may be disturbed. Keep the charger 1 m (3.28 feet) or more away from radios.
- The charger may generate whirring sounds when it is being used. This is not a malfunction.
- After using the charger, be sure to disconnect it from the electrical outlet. (A very small amount of current is consumed if it is left connected.)
- Keep the terminals of the charger and battery clean.

Message Display

Confirmation messages or error messages will be displayed on the screen in some cases.

The major messages are described below as examples.

[THIS MEMORY CARD IS PROTECTED]

The Write-Protect switch on the SD Memory Card or the SDHC Memory Card is slid to the [LOCK] side. Slide it to the other side to unlock it. (P20, 107, 111)

[NO VALID PICTURE TO PLAY]

Record a picture or insert a card with a recorded picture and then play it.

[THIS PICTURE IS PROTECTED]

Delete or overwrite the picture after canceling the protect setting. (P107)

[THIS PICTURE CANNOT BE DELETED]/ [SOME PICTURES CANNOT BE DELETED]

Pictures not based on the DCF standard cannot be deleted. If you want to delete some pictures, format the card after saving necessary data on a PC etc. (P111)

[NO ADDITIONAL DELETE SELECTIONS CAN BE MADE]

You have exceeded the number of pictures that can be set at once with

[MULTI DELETE]. Delete the selected pictures and then select [MULTI DELETE] again to delete any remaining pictures. More than 999 favorites have been set.

[CANNOT BE SET ON THIS PICTURE]/ [CANNOT BE SET ON SOME PICTURES]

If the pictures are not based on the DCF standard, the DPOF print cannot be set.

[MEMORY CARD ERROR FORMAT THIS CARD?]

The card format cannot be recognized by the camera. Format the card again with the camera after saving necessary data on a PC etc. (P111)

[PLEASE TURN CAMERA OFF AND THEN ON AGAIN]

This message appears when you exert pressure on the lens with your hand etc. or the camera is not operating properly. Turn the camera off and on. If the message persists, contact the dealer or your nearest servicenter.

[MEMORY CARD ERROR PLEASE CHECK THE CARD]

- An error has occurred accessing the card. Insert the card again.

[READ ERROR PLEASE CHECK THE CARD]

An error has occurred reading the data. Insert the card again. Make sure the card is inserted properly and then play back again.

[WRITE ERROR PLEASE CHECK THE CARD]

An error has occurred writing the data. Turn the camera off and remove the card. Insert the card again and turn the camera on. Make sure the camera is turned off before removing or inserting the card to avoid damage.

[MOTION RECORDING WAS CANCELLED DUE TO THE LIMITATION OF THE WRITING SPEED OF THE CARD]

- When you set the picture quality to [30fpsVGA] or [30fps16:9], we recommend using a high speed SD Memory Card with “10MB/s” or greater displayed on the package.
- Depending on the type of SD Memory Card or SDHC Memory Card, recording may stop in the middle.

[A FOLDER CANNOT BE CREATED]

A folder cannot be created because there are no remaining folder numbers that can be used. (P113)

Format the card after saving necessary data on a PC etc. (P111) If you execute [NO.RESET] in the [SETUP] menu after formatting, the folder number is reset to 100. (P29)

[PICTURE IS DISPLAYED FOR 4:3 TV]/ [PICTURE IS DISPLAYED FOR 16:9 TV]

- The AV cable is connected to the camera. Press [MENU/SET] if you want to delete this message at once.
- Select [TV ASPECT] in the [SETUP] menu to change the TV aspect. (P30)
- This message also appears when the USB connection cable is connected to the camera only.

In this case, connect the other end of the USB connection cable to a PC or a printer. (P112, 115)

Troubleshooting

If you return the menu settings to the initial settings at the time of purchase, the condition may improve.

Select [RESET] in the [SETUP] menu. (P30)

■ Battery and power source

1: The camera cannot be operated even when it is turned on.

- Is the battery inserted correctly?
- Is the battery sufficiently charged?
 - Use a battery that has been sufficiently charged.

2: The LCD monitor turns off while the camera is turned on.

- Does the picture appear on the viewfinder?
 - Press the [EVF/LCD] button to switch to LCD monitor display.
- Is power save mode (P29) activated?
 - Press the shutter button halfway to cancel these modes.
- Is the battery exhausted?
 - Charge the battery or replace it with a battery which has enough capacity.

3: The camera turns off immediately after it is turned on.

- Is the battery charge insufficient to operate the camera?
 - Use a battery that has been sufficiently charged.
 - If you leave the camera on, the battery will be exhausted. Turn the camera off frequently by using power save mode (P29) etc.

■ Recording

1: The picture cannot be recorded.

- Is the card inserted?
- Is the mode dial correctly set?
- Is there any memory remaining on the card?

– Before recording, delete some pictures. (P41)

2: The recorded picture is whitish.

The lens is dirty.

- The picture can become whitish if there is dirt e.g. fingerprints on the lens. When the lens is dirty, turn the camera on and lightly wipe the surface of the lens with a soft dry cloth.

3: The recorded picture is too bright or dark.

- Check that the exposure is correctly compensated. (P52)

4: 2 or 3 pictures are taken at one time.

- Is auto bracket (P53) or burst mode set? (P55)

5: The subject is not focused properly.

- The focus range varies depending on the recording mode. Rotate the mode dial to set the proper mode for the distance to the subject.
- Is the subject beyond the focus range of the camera? (P34)
- Have you taken a picture with jitter?

6: The recorded picture is blurred. The optical image stabilizer is not effective.

- The shutter speed will become slower and the optical image stabilizer function may not work properly when taking pictures especially in dark places. In this case, we recommend holding the camera firmly with both hands when taking pictures. (P33) We recommend using a tripod and the self-timer (P51) when taking pictures with a slow shutter speed.

7: The recorded picture looks rough.

Noise appears on the picture.

- Is the ISO sensitivity high or the shutter speed slow? (ISO sensitivity is set to [100] when the camera is shipped. Therefore, when

taking pictures indoors etc. the ISO sensitivity increases.)

- Decrease the ISO sensitivity. (P85)
- Set [NOISE REDUCTION] in [PICT.ADJ.] to [HIGH] or set every item except [NOISE REDUCTION] to [LOW]. (P94)
- Take pictures in bright places.
- In [HIGH SENS.] (P70) in scene mode, the resolution of the recorded picture decreases slightly because of high sensitivity processing. This is not a malfunction.

8: Motion picture recording stops in the middle.

- Are you using a MultiMediaCard?
 - This unit does not support MultiMediaCards.
- When you set the picture quality to [30fpsVGA] or [30fps16:9], we recommend using a high speed SD Memory Card with “10MB/s” or greater displayed on the package.
- Depending on the type of SD Memory Card or SDHC Memory Card, recording may stop in the middle.

9: When the shutter button is pressed halfway, the image becomes a still image for that instant.

- Is 3-area focusing (High speed) or 1-area focusing (High speed) selected as the AF mode? (P90)

■ LCD monitor/viewfinder

1: The LCD monitor/viewfinder becomes darker or brighter for a moment.

- This phenomenon appears when you press the shutter button halfway to set the aperture value and does not affect the recorded pictures.

2: The LCD monitor flickers indoors.

- The LCD monitor may flicker for a few seconds after turning the camera on indoors under fluorescent light. This is not a malfunction.

3: The LCD monitor/viewfinder is too bright or dark.

- Adjust the brightness of the screen. (P28)
- Is the power LCD function activated?

4: The picture is not displayed on the LCD monitor.

- Does the picture appear on the viewfinder?
 - Press the [EVF/LCD] button to switch to LCD monitor display.

5: Black, red, blue and green dots appear on the LCD monitor.

- These pixels do not affect the recorded pictures.
This is not a malfunction.

6: Noise appears on the LCD monitor.

- In dark places, noise may appear to maintain the brightness of the LCD monitor.
This does not affect the pictures you are recording.

7: A vertical line appears on the LCD monitor.



- This is a phenomenon called smear. It is a characteristic of CCD and appears when the subject has a bright part. Uneven colors may also appear around the smear. This is not a malfunction. It is recorded in motion pictures but is not recorded on still pictures.

8: Distortion in the LCD monitor.

- When holding the edge of the LCD monitor, there may be some distortion, however this is not a malfunction. Moreover, this has no effect on the taken pictures or playback.

■ Flash

1: The flash is not activated.

- Is the flash setting set to Forced OFF ?
 - Press the [ OPEN] button to open the flash. (P47)
- The flash is not activated when motion picture mode [, [SCENERY] (P65), [NIGHT SCENERY] (P66), [FIREWORKS] (P68), [HIGH SENS.] (P70) or [STARRY SKY] (P68) in scene mode is selected.

2: The flash is fired 2 times.

- When you select red-eye reduction (P47), the flash is fired once before the actual recording to reduce the red-eye phenomenon (eyes of the subject appearing red in the picture) and then fired again for the actual recording.

■ Playback

1: The picture being played back is rotated and displayed in an unexpected direction.

The camera has a function that automatically rotates the display of pictures recorded holding the camera vertically. (If you take pictures when aiming the camera up or down, the camera may recognize that it is being held vertically.)

- You can display the pictures without being rotated when [ROTATE DISP.] (P104) is set to [OFF].
- You can rotate pictures with the [ROTATE] function. (P104)

2: The picture is not played back.

- Is the mode dial set to playback []?
- Is the card inserted?
- Is there a picture in the card?

3: The folder number and the file number are displayed as [—] and the screen turns black.

- Is the picture edited with a PC or recorded with a digital camera from another manufacturer?

This may also happen if the battery is removed immediately after recording or if recording with a exhausted battery.

- Format the data to delete the pictures mentioned above. (P111) (Formatting irretrievably deletes all data including the other pictures. Check the data carefully before formatting.)

4: The picture is displayed with a date different from the actual recording date in calendar playback.

- Was the picture edited with a PC or recorded with a digital camera from another manufacturer?
This kind of picture may be displayed with a date different from the actual recording date in calendar playback. (P79)
- Is the clock in the camera set properly? (P28)

For example, if the clock setting on the camera is different from the date and time set on the PC and you acquire pictures recorded with the camera to the PC and then write them back to the card, the pictures may be displayed with dates different from the actual recording dates in calendar playback etc.

■ TV, PC and printer

1: The picture does not appear on the television.

- Is the camera connected to the TV correctly?
- Set the TV input to external input mode.

2: The display areas on the TV screen and the camera's LCD monitor are different.

Depending on the TV model, the area display may be smaller so the picture may be stretched horizontally or vertically and the top and bottom or left and right of the picture may be cut off when it is displayed. This is due to the TV specifications and is not a malfunction.

3: The motion pictures cannot be played back on a TV.

- Are you trying to play back the motion pictures by directly inserting the card in the card slot of the TV?
– Connect the camera to the TV with the AV cable (supplied) and then play back the pictures on the camera.

4: The picture cannot be transferred when the camera is connected to a PC.

- Is the camera connected to the PC correctly?
- Is the camera recognized by the PC correctly?
- Set [USB MODE] to [PC]. (P30, 112)

5: The card is not recognized by the PC.

- Disconnect the USB connection cable. Connect it again while the card is inserted in the camera.

6: The picture cannot be printed when the camera is connected to a printer.

- Does the printer support PictBridge?
– You cannot print pictures with printers which do not support PictBridge. (P115)
- Set [USB MODE] to [PictBridge (PTP)]. (P30, 115)

7: The ends of the pictures are cut at printing.



- When using a printer with a trimming or borderless printing function, cancel this function before printing. (For details, refer to the operating instructions for the printer.)
- When you order photo studios to print pictures, ask the photo studio if the pictures can be printed with both ends.

8: The picture is not displayed fully on the TV.

- Set the aspect of the TV on the camera. (P30)

■ Others

1: An unreadable language was selected by mistake.

- Press [MENU/SET], select the [SETUP] menu icon [] and then select the [] icon to set the desired language. (P31)

2: The camera will make sounds caused by internal mechanical movement when it is shaken.

- The sound arises when the lens moves.
This is not a malfunction.

3: The setting for the auto review function is disabled.

- Are you taking pictures using auto bracket (P53)? Is the camera in continuous mode (P55) or motion picture mode [] (P76)? Is [AUDIO REC.] set to [ON] (P89)?
 - In these cases, you cannot set the auto review function in the [SETUP] menu.

4: A red lamp sometimes turns on when the shutter button is pressed halfway.

- In dark places, the AF assist lamp (P91) lights red to make it easier to focus on a subject.

5: The AF assist lamp does not turn on.

- Is [AF ASSIST LAMP] on the [REC] mode menu set to [ON]? (P91)
- Are you taking pictures in dark places?
 - The AF assist lamp does not turn on in bright places.
- The AF assist lamp does not turn on when [SCENERY] (P65), [NIGHT SCENERY] (P66), [FIREWORKS] (P68) or [PANNING] (P66) in scene mode is selected.

6: The camera becomes warm.

- The surface of the camera may become warm during use. This does not affect the performance or quality of the camera.

7: The lens clicks.

- When the brightness changes due to zoom or camera movement etc., the lens may click and the picture on the screen may drastically change. However, the picture is not affected. The sound is caused by the automatic adjustment of the aperture. This is not a malfunction.

8: The clock is reset.

- If you do not use the camera for a long time, the clock may be reset. When the message [PLEASE SET THE CLOCK] appears, set the clock again. (P26)
- When you take a picture before setting the clock, [0:00 0. 0.] is recorded.

9: The file numbers are not recorded consecutively.

- When you perform an operation after taking a certain action, the pictures may be recorded in folders with different numbers from the ones used prior to the operation. (P113)

10: The file numbers are recorded in ascending order.

- If the battery is inserted or removed when the camera is not turned off, the recorded folder numbers are lost. However if you turn the camera on again and record pictures, the recorded folder numbers are different from the prior recorded folder numbers.





11: The picture is not displayed.







- Pictures edited or rotated with a PC may not be displayed in playback mode (P40), multi playback (P78) and calendar playback (P79).
-

Number of recordable pictures and available recording time

- The number of recordable pictures and the available recording time are an approximation. (These vary depending on the recording conditions and the type of card.)
- The number of recordable pictures varies depending on the subjects.

■ Number of recordable pictures

Aspect ratio		4:3				
Picture size		10M (10M): (3648×2736 pixels)			8M (8M EZ): (3264×2448 pixels)	
Quality		RAW				
Card	16 MB	0	2	5	2	6
	32 MB	1	5	11	6	14
	64 MB	2	11	24	14	30
	128 MB	5	24	49	30	61
	256 MB	10	48	97	61	120
	512 MB	21	97	190	120	240
	1 GB	42	195	380	240	480
	2 GB	86	390	780	490	970
4 GB	170	770	1540	970	1910	

Aspect ratio		4:3					
Picture size		5M (5M EZ): (2560×1920 pixels)		3M (3M EZ): (2048×1536 pixels)		2M (2M EZ): (1600×1200 pixels)	
Quality							
Card	16 MB	5	10	8	16	13	27
	32 MB	11	23	18	36	29	58
	64 MB	24	48	38	75	61	120
	128 MB	50	99	78	150	125	240
	256 MB	98	190	150	290	240	470
	512 MB	195	380	300	590	480	940
	1 GB	390	770	600	1180	970	1880
	2 GB	790	1530	1220	2360	1920	3610
4 GB	1560	3010	2410	4640	3770	7090	

Aspect ratio		3:2								
Picture size		8M (8.5M): (3600×2400 pixels)			7M (7M EZ): (3248×2160 pixels)		4.5M (4.5M EZ): (2560×1712 pixels)		2.5M (2.5M EZ): (2048×1360 pixels)	
Quality		RAW								
Card	16 MB	0	2	5	3	7	5	12	9	18
	32 MB	1	6	13	7	16	13	26	20	40
	64 MB	3	13	27	17	34	27	54	43	83
	128 MB	6	28	57	35	70	56	110	88	165
	256 MB	12	56	110	69	135	110	210	170	330
	512 MB	23	110	220	135	270	210	430	340	650
	1 GB	48	220	440	270	540	440	860	680	1310
	2 GB	97	450	900	560	1090	890	1700	1360	2560
	4 GB	190	900	1770	1100	2150	1740	3350	2680	5020

Aspect ratio		16:9						
Picture size		7M (7M): (3584×2016 pixels)			5.5M (5.5M EZ): (3072×1728 pixels)		2M (2M EZ): (1920×1080 pixels)	
Quality		RAW						
Card	16 MB	0	3	7	4	10	12	25
	32 MB	1	7	16	10	21	27	53
	64 MB	3	16	33	22	45	57	105
	128 MB	7	34	68	46	92	115	220
	256 MB	14	67	130	91	180	230	430
	512 MB	28	130	260	180	350	450	860
	1 GB	56	260	530	360	710	910	1720
	2 GB	115	540	1070	730	1420	1800	3410
	4 GB	220	1060	2110	1450	2800	3540	6700

■ Available recording time

Picture quality setting		30fps VGA	10fps VGA	30fps QVGA	10fps QVGA	30fps 16:9	10fps 16:9
SD Memory Card	16 MB	6 s	26 s	26 s	1 min 23 s	5 s	22 s
	32 MB	17 s	59 s	59 s	2 min 55 s	14 s	50 s
	64 MB	39 s	2 min	2 min	6 min	33 s	1 min 46 s
	128 MB	1 min 23 s	4 min 10 s	4 min 10 s	12 min 20 s	1 min 11 s	3 min 35 s
	256 MB	2 min 45 s	8 min 10 s	8 min 10 s	24 min	2 min 20 s	7 min
	512 MB	5 min 30 s	16 min 20 s	16 min 20 s	47 min 50 s	4 min 40 s	14 min
	1 GB	11 min	32 min 50 s	32 min 50 s	1 h 35 min 50 s	9 min 20 s	28 min 10 s
	2 GB	22 min 30 s	1 h 7 min	1 h 7 min	3 h 15 min	19 min 20 s	57 min 30 s
SDHC Memory Card	4 GB*	44 min 20 s	2 h 11 min 50 s	2 h 11 min 50 s	6 h 22 min 50 s	38 min	1 h 53 min 10 s

- * Motion pictures can be recorded continuously up to 2 GB.
The maximum available recording time for up to 2 GB only is displayed on the screen.



-
- If you set the quality to [RAW], the picture size is fixed to the maximum picture size for each aspect ratio.
 - The number of recordable pictures and the available recording time displayed on the LCD monitor/Viewfinder may not decrease in order.
 - This unit does not support recording motion pictures on MultiMediaCards.
 - The extended optical zoom does not work in [HIGH SENS.] (P70) in scene mode so the picture size for [EZ] is not displayed.

Specifications

Camera:

Power Source:	DC 8.4 V
Power Consumption:	1.7 W (When recording with LCD Monitor) 1.7 W (When recording with Viewfinder) 1.0 W (When playing back with LCD Monitor) 1.0 W (When playing back with Viewfinder)
Camera Effective pixels:	10,100,000 pixels
Image sensor:	1/1.8" CCD, total pixel number 10,370,000 pixels Primary color filter
Lens:	Optical 12× zoom, f=7.4 mm to 88.8 mm (35 mm film camera equivalent: 35 mm to 420 mm)/F2.8 to F3.7
Digital zoom:	Max. 4×
Extended optical zoom:	Max. 21.4×
Focus:	Normal/AF MACRO/Manual, 9-area-focusing/3-area-focusing (High speed)/ 1-area-focusing (High speed)/1-area-focusing/Spot-focusing
Focus range:	AF: 30 cm (0.98 feet) (Wide)/2 m (6.56 feet) (Tele) to ∞ AF MACRO/MF: 5 cm (0.16 feet) (Wide)/2 m (6.56 feet) (Tele) to ∞
Shutter system:	Electronic shutter+Mechanical shutter
Continuous recording	
Frequency:	2 pictures/second (High speed), 1 picture/second (Low speed), Approx. 1 picture/second (Unlimited)
Number of recordable pictures:	Max. 5 pictures (Standard), max. 3 pictures (Fine), Depends on the remaining capacity of the card. (Unlimited) (Performance in burst recording is only with SD Memory Card/SDHC Memory Card. MultiMediaCard performance will be less.)
Motion picture recording:	848×480 pixels/640×480 pixels/320×240 pixels (30 or 10 frames/second with audio. The maximum recording time depends on the capacity of the card.)
ISO sensitivity:	AUTO/  ISO/100/200/400/800/1600 [HIGH SENS.] mode: 3200
Shutter speed:	60 to 1/2000th of a second [STARRY SKY] mode: 15 seconds, 30 seconds, 60 seconds Motion picture mode: 1/30th of a second to 1/6400th of a second
White balance:	AUTO/Daylight/Cloudy/Shade/Halogen/Flash/White set1/ White set2
Exposure (AE):	Program AE (P)/Aperture-priority AE (A)/ Shutter-priority AE (S)/Manual exposure (M) Exposure compensation (1/3 EV Step, -2 EV to +2 EV)
Metering mode:	Multiple/Center weighted/Spot
LCD monitor:	2.0" low-temperature polycrystalline TFT LCD (207,000 pixels) (field of view ratio about 100%)

Viewfinder:	Color LCD Viewfinder (230,000 pixels) (field of view ratio about 100%) (with diopter adjustment -4 to +4 diopter)
Flash:	Built-in pop up flash Flash range: (ISO AUTO) Approx. 30 cm (0.98 feet) to 7.4 m (24.28 feet) (Wide) AUTO, AUTO/Red-eye reduction, Forced ON (Forced ON/ Red-eye reduction), Slow sync./Red-eye reduction, Forced OFF
Microphone:	Monaural
Speaker:	Monaural
Recording media:	SDHC Memory Card/SD Memory Card/MultiMediaCard (Still pictures only)
Picture size	
Still picture:	When the aspect ratio setting is [4:3] 3648×2736 pixels, 3264×2448 pixels, 2560×1920 pixels, 2048×1536 pixels, 1600×1200 pixels When the aspect ratio setting is [3:2] 3600×2400 pixels, 3248×2160 pixels, 2560×1712 pixels, 2048×1360 pixels When the aspect ratio setting is [16:9] 3584×2016 pixels, 3072×1728 pixels, 1920×1080 pixels
Motion pictures:	When the aspect ratio setting is [4:3] 640×480 pixels/320×240 pixels When the aspect ratio setting is [16:9] 848×480 pixels
Quality:	Fine/Standard/RAW
Recording file format	
Still Picture:	JPEG (Design rule for Camera File system, based on Exif 2.21 standard)/ RAW, DPOF corresponding
Picture with audio:	JPEG (Design rule for Camera File system, based on Exif 2.21 standard)+640×480 pixels QuickTime (picture with audio)
Motion pictures:	QuickTime Motion JPEG (motion pictures with audio)
Interface	
Digital:	USB 2.0 (Full Speed)
Analog video/audio:	NTSC/PAL Composite (Switched by menu), Audio line output (monaural)
Terminal	
REMOTE:	ø 2.5 mm jack
AV OUT/DIGITAL:	Dedicated jack (8 pin)
DC IN:	type 3 jack
Dimensions:	Approx. 131.2 mm (W)×85.5 mm (H)×142 mm (D) (5 11/64" (W)×3 3/8" (H)×5 19/32" (D)) (excluding the projecting part)
Mass:	Approx. 668 g/23.56 oz (excluding Memory Card and battery) Approx. 714 g/25.19 oz (with Memory Card and battery)
Operating Temperature:	0 °C to 40 °C (32 °F to 104 °F)
Operating Humidity:	10% to 80%

**Battery Charger
(LEICA BC-DC5):**





Input:	110 V to 240 V ~ 50/60 Hz, 0.15 A
Output:	CHARGE 8.4 V = 0.43 A

Equipment mobility: Movable

**Battery Pack (lithium-ion)
(LEICA BP-DC5):**

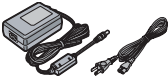
Voltage/capacity:	7.2 V, 710 mAh
--------------------------	----------------

Accessories

Accessory	Figure	Description
18657 18658 18661		AC Adaptor ACA-DC5-E ACA-DC5-US ACA-DC5-UK/HK
(A): 18670 (B): 18671		(A): UVa Filter (B): Polarizing Filter
18626		Remote Control Unit CR-DC1
18666		Cordura Case
18665		Neoprene Case

Installing the Software on the CD

The supplied CD contains Adobe Photoshop® Elements® (Windows® V4.0, Mac® V3.0) and Apple QuickTime® V6.3 (English) for Windows®.

Installation of Adobe Photoshop® Elements®

Notice: The serial numbers for Adobe Photoshop® Elements® are printed on the CD-ROM paper sleeve.

With Windows® computers

(Windows® XP and higher; Windows® Media Center Edition 2005 and higher)
Insert the CD-ROM into your CD/DVD drive. Usually the Adobe Photoshop® Elements® installer will start automatically. If not, open the CD/DVD drive in the Windows® Explorer. In the root directory you will find the installer file [setup.exe]. Double click this file and the installer will start. You need to be logged in as administrator. Follow the instructions.

With MACINTOSH® computers

(Mac® OS X Version 10.2.8 and 10.3 and later)

Insert the CD into your CD/DVD drive. Open the corresponding window. Double click on the file "Install Adobe® Photoshop Elements"

[in D: "Adobe Photoshop® Elements® installieren"; in F: "Installer Adobe® Photoshop Elements"] and follow the instructions.

Working with RAW data

If you select the RAW picture format you can set the individual parameters and picture properties yourself. To do this you need the supplied Adobe Photoshop® Elements® 4 (Win) / 3 (Mac), as well as the newest Adobe Camera RAW (ACR) plug-in, which you can download from www.adobe.com.

This program is capable of opening raw data files in the RAW format and to convert them at high quality. During editing you can retrospectively change parameters such as white balance, tone values, gradation, sharpness etc., so as to achieve the highest picture quality.

Installation of Quick Time for Windows (Windows 2000 and higher):

Notice: Apple QuickTime® is required to playback AUDIO and VIDEO files created by the LEICA V-LUX 1.

Insert the CD into your CD/DVD drive. Usually the Adobe Photoshop® Elements® installer will start automatically. Cancel the installer and open the CD/DVD drive in the Windows Explorer.

In the subfolder "Apple QuickTime" double click the file "QuickTimeInstaller.exe" and follow the instructions to install the software.

Notice: Leave the field for the serial number blank and continue.

Updates and further language versions are available for download at www.apple.com/quicktime

Notice: Restart your computer after the installation of the software to finalize the installation process.

Only for Great Britain

Camera



The rating plate is on the underside of the digital camera.

Caution for AC mains lead

For your safety, please read the following text carefully.

This appliance is supplied with a moulded three-pin mains plug for your safety and convenience. A 5-ampere fuse is fitted in this plug.

Should the fuse need to be replaced, please ensure that the replacement fuse has a rating of 5-amperes and it is approved by ASTA or BSI to BS1362.

Check for the ASTA mark  or the BSI mark  on the body of the fuse.

If the plug contains a removable fuse cover you must ensure that it is refitted when the fuse is replaced. If you lose the fuse cover, the plug must not be used until a replacement cover is obtained. A replacement fuse cover can be purchased from your local Leica Dealer.

IF THE FITTED MOULDED PLUG IS UNSUITABLE FOR THE SOCKET OUTLET IN YOUR HOME THEN THE FUSE SHOULD BE REMOVED AND THE PLUG CUT OFF AND DISPOSED OF SAFELY.

THERE IS A DANGER OF SEVERE ELECTRICAL SHOCK IF THE CUT OFF PLUG IS INSERTED INTO ANY 13- AMPERE SOCKET.

If a new plug is to be fitted, please observe the wiring code as shown below. If in any doubt, please consult a qualified electrician.

IMPORTANT

The wires in this mains lead are coloured in accordance with the following code:

Blue: Neutral

Brown: Live

As the colours of the wires in the mains lead of this appliance may not correspond with the coloured markings identifying the terminals in your plug, proceed as follows:

The wire which is coloured BLUE must be connected to the terminal in the plug which is marked with the letter N or coloured BLACK.

The wire which is coloured BROWN must be connected to the terminal in the plug which is marked with the letter L or coloured RED.

Under no circumstances should either of these wires be connected to the earth terminal of the three-pin plug, marked with the letter E or the Earth Symbol. ⚡

Before Use

Remove the Connector Cover.

How to replace the Fuse

The location of the fuse differ according to the type of AC mains plug (figures A and B). Confirm the AC mains plug fitted and follow the instructions below.

Illustrations may differ from actual AC mains plug.

- 1) Open the fuse cover with a screwdriver.

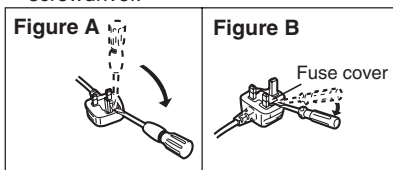

- 2) Replace the fuse and close or attach the fuse cover.

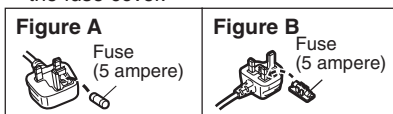

Index

A

AC Adaptor	112, 115
Adjusting Flash Output	49
AE Lock Button	35
AF Assist Lamp	91
AF Mode	90
AF/AE Lock	34
Aperture-priority AE	59
Aspect Ratio	87
Aspect Ratio Conversion	110
Audio Dubbing	108
Audio Recording	76, 89
Auto Bracket	53
Auto Review	28
Available Recording Time	131

B

Baby Mode	69
Backlight Compensation	36
Brightness of the LCD Monitor/ Viewfinder	28
Built-in Flash	47

C

Calendar Playback	79
Candle Light Mode	68
Card Access Indication	20
Center Weighted	89
Changing the Zoom Area	61
Charger	122
Charging	16
Clock Set	26, 28
Color Effect	94
Condensation	5
Continuous AF	91
Continuous Mode	55
Custom Mode	63

D

Date Printing	106, 116, 117
Deleting Pictures	41
Demonstration of the Optical Image Stabilizer	54
Digital Zoom	38
Diopter Adjustment	44
DPOF Print Setting	105

E

Exposure	35
Exposure Compensation	52
Extended Optical Zoom	37
External Flash	99
External Flash Burst Mode	101
EZ	37, 87

F

File Number	14, 29, 113
Fine	88
Fireworks Mode	68
Flip Animation	95
Focus	34
Folder Composition	113
Folder Number	14, 29, 113
Food Mode	67
Formatting	111

G

Guide Line	28
------------------	----

H

High Sensitivity Mode	70
Highlight Display	30
Highlight Feature	44
Histogram	46
Hood Adaptor	22

I

Intelligent ISO sensitivity control	86
ISO Sensitivity	85

J

Jitter	35
--------------	----

L

Language Setting	31
Layout	116
LCD Monitor	13
LCD Monitor/Viewfinder	43
Leica Academy	142
Leica on the Internet	142
Leica Information Service	143
Leica Customer Service	143
Lens Cap	21
Lens Hood	22

M		Prefocus	61
Macro Mode	56	Program AE	32
MANUAL	103	Protect	107
Manual Exposure	59	Q	
Manual Exposure Assistance	58	Quality	87
Manual Focus	60	R	
Mass Storage	30	RAW	88
Metering Mode	89	Remote Control Unit	120
MF Assist	29, 60	Reset of Setting	30
Monitor Priority	29, 44	Resizing	108
Motion Picture Mode	76	Review	39
Multi Playback	78	Rotate	104
Multiple	89	Rotate Display	104
N		S	
Night Portrait Mode	66	Scene Menu	31
Night Scenery Mode	66	Scene Mode	64
NO.RESET	29	Scenery Mode	65
NTSC	30	Selecting the AF area	90
Number of Prints	106, 116	Self-timer	51
Number of Recordable Pictures	16, 129	Setting Favorites	103
O		Setup Menu	27
One Shot AF	61	Shutter sound	29
Operational Sound	29	Shutter-priority AE	59
Optical Image Stabilizer	54	Slide Show	102
Optical Zoom	37	Snow Mode	70
Out-of-frame Display	44	Soft Skin Mode	65
P		Sports Mode	65
PAL	30	Spot	89
Panning Mode	66	Spot-focusing	90
Paper Size	116	Standard	88
Party Mode	67	Starry Sky Mode	68
PC	30, 112	Strap	21
PictBridge	30, 115	T	
Picture Adjustment	94	Travel Date	28, 71
Picture Quality Setting (Motion Picture Mode)	76	Trimming	109
Picture Size	87	TV Aspect	30
Pictures with Audio	81	U	
Playback Pictures on TV	118	USB Connection Cable	112, 115
Playback Zoom	80	USB Mode	30, 112, 115
Playing Back Motion Pictures	81	UVa Filter	97
Polarizing Filter	97	V	
Portrait Mode	65	Video Output	30, 118
Power Indicator	32	Volume of Speakers	29
Power Save	29		

W

White Balance	83
White Balance Fine Adjustment	85
White Set	84
World Time	28, 73

Leica Academy

As well as outstanding high-performance products for taking, reproducing and viewing photographs, for many years we have also been offering the special services of the Leica Akademie, with practical seminars and training courses, which are intended to share our knowledge about the world of photography, projection and magnification with both beginners and advanced photographic enthusiasts.

The contents of the courses, which are run by a trained team of experts in the modern, well-equipped training suite at our Solms factory and in the Hofgut Altenberg, vary from general photography to areas of special interest and offer a range of suggestions, information and advice for your own work.

You can obtain the current Leica Akademie brochure from:

Leica Camera AG

Leica Akademie

Oskar-Barnack-Straße 11

D-35606 Solms

Tel: +49 (0) 6442-208-421

Fax: +49 (0) 6442-208-425

la@leica-camera.com

Leica on the Internet

Current information about products, news, events and the Leica company is available on our homepage on the Internet at:

<http://www.leica-camera.com>

Leica Information Service

The Leica information service can provide you with an answer to any technical questions relating to the Leica range either in writing, on the telephone or by e-mail.

Leica Camera AG
Informations-Service
Postfach 1180
D-35599 Solms
Tel: +49 (0) 6442-208-111
Fax: +49 (0) 6442-208-339
info@leica-camera.com

Leica Customer Service

Leica AG's Customer Service center, or the repair service of the Leica national offices, is available to assist you in maintaining your Leica equipment or in case of damage. Please contact your nearest authorized Leica dealer.

Leica Camera AG
Customer Service
Solmsger Gewerbepark 8
D-35606 Solms
Tel: +49 (0) 6442-208-189
Fax: +49 (0) 6442-208-339
customer.service@leica-camera.com



my point of view

Leica Camera AG / Oskar-Barnack-Str. 11 / D-35606 Solms
www.leica-camera.com / info@leica-camera.com
Telefon +49 (0) 64 42-208-0 / Telefax +49 (0) 64 42-208-333