

OLYMPUS[®]

DIGITAL CAMERA

FE-45/X-40 ***FE-35/X-30***

Instruction Manual

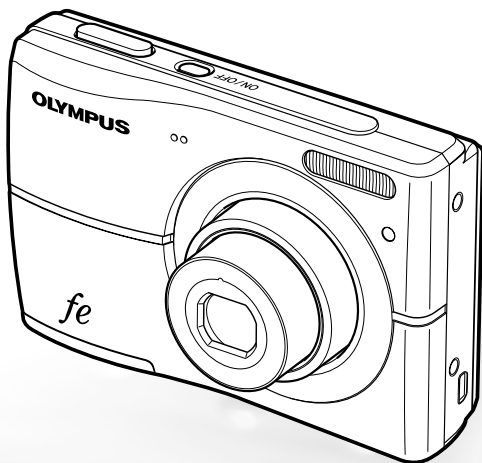

- Thank you for purchasing an Olympus digital camera. Before you start to use your new camera, please read these instructions carefully to enjoy optimum performance and a longer service life. Keep this manual in a safe place for future reference.
- We recommend that you take test shots to get accustomed to your camera before taking important photographs.
- In the interest of continually improving our products, Olympus reserves the right to update or modify information contained in this manual.
- The screen and camera illustrations shown in this manual were produced during the development stages and may differ from the actual product. Unless otherwise specified, the explanation about these illustrations is provided for FE-45/X-40.

Step 1

Checking the contents of the box



Digital camera



Strap



Two AA batteries



USB cable



AV cable
(FE-45/X-40)

or



Video cable
(FE-35/X-30)



OLYMPUS Master 2
CD-ROM



microSD
Attachment

Other accessories not shown: Instruction Manual (this manual), warranty card.
Contents may vary depending on purchase location.

Step 2

Preparing the Camera

"Preparing the Camera" (p. 10)

Step 3

Shooting and Playing Back Images

"Shooting, Playback, and Erasing" (p. 14)

Step 4

How to Use the Camera

"Three Types of Setting Operations" (p. 3)

Step 5

Printing

"Direct printing (PictBridge)" (p. 34)

"Print Reservations (DPOF)" (p. 37)

Contents

➤ Names of Parts	6	➤ Menus for Playback, Editing, and Printing Functions.....	28
➤ Preparing the Camera	10	➤ Menus for Other Camera Settings ..	30
➤ Shooting, Playback, and Erasing ...	14	➤ Printing	34
➤ Using Shooting Modes.....	17	➤ Using OLYMPUS Master 2.....	39
➤ Using Shooting Functions.....	19	➤ Usage Tips	41
➤ Using Playback Features	23	➤ Appendix	45
➤ Menus for Shooting Functions.....	24	➤ Index	56

Three Types of Setting Operations

Using the Menu

Various camera settings can be accessed through the menus, including functions used during shooting and playback and the date/time and screen display.

- There may be menus that are unavailable depending on other related settings or the **SCN** mode (p. 17).

1 Press the **MENU** button.

- This example describes how to use the menus to set the [POWER SAVE].

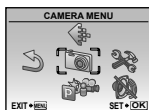

Shooting mode top menu

2 Use \leftarrow \rightarrow \uparrow \downarrow to select the desired menu, and press the **OK** button.

- Pressing and holding the **?** button displays an explanation (menu guide) of the selected option.

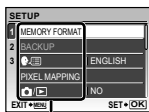

Submenu 1

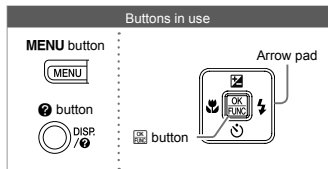

3 Use \leftarrow \rightarrow to select the desired Submenu 1, and press the **OK** button.

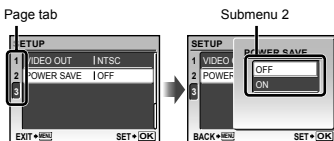

- To quickly move to the desired submenu, press **?** to highlight the page tab, and then use \leftarrow \rightarrow to move the page. Press **?** to return to the submenu.

- Some menus include submenus that appear by pressing the **OK** button.

4 Use \leftarrow \rightarrow to select Submenu 2, and press the **OK** button.

- Once a setting is selected, the display returns to the previous screen.

- There may be additional operations. "Menu Settings" (p. 24 to 33)

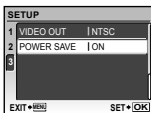







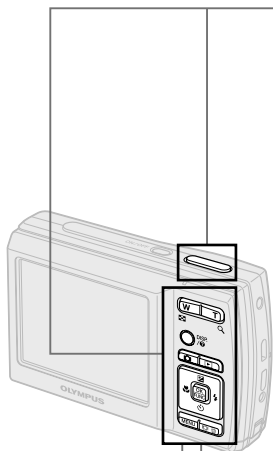











5 Press the **MENU** button to complete the setting.

Using the Direct Buttons

Frequently used shooting functions can be accessed using the direct buttons.



-  Shutter button (p. 14)
-   button (shooting/switching shooting modes) (p. 17, 18)
-   button (playback) (p. 15)
-  Zoom buttons (p. 19)
-   button (exposure compensation) (p. 20)
-   button (macro) (p. 20)
-   button (flash) (p. 19)
-   button (self-timer) (p. 21)
-   button (changing information display/ menu guide) (p. 22, 23/p. 17)
-   button (backlight boost/erase) (p. 21/p. 16, 29)

Using the FUNC Menu (p. 22)

Frequently used shooting menu functions can be set with less steps using the FUNC menu.

-  button (p. 22)

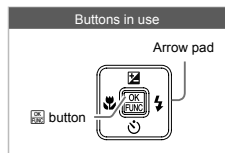

Menu Index

Menus for Shooting Functions

In shooting mode, settings can be adjusted.

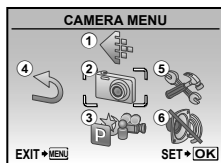
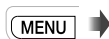

Shooting mode top menu

① IMAGE QUALITY..... p. 24	iAUTO p. 17 p. 31
② CAMERA MENU	DIS MODE..... p. 18	SAVE SETTINGS p. 31
WB..... p. 25	SCN p. 17	MENU COLOR p. 31
ISO..... p. 25	MOVIE p. 18	BEEP p. 31
(Still images ¹ /movies ¹)	RESET..... p. 27	(Monitor) p. 31
..... p. 25	④ ↻	(Date/time)..... p. 31
PANORAMA p. 26	⑤	VIDEO OUT..... p. 32
FACE DETECT p. 26	SETUP	POWER SAVE..... p. 33
③ SWITCH SHOOTING	MEMORY FORMAT/	⑥
MODES	FORMAT p. 30	SILENT MODE p. 33
P p. 14	BACKUP..... p. 30	
	(Language)..... p. 30	
	PIXEL MAPPING p. 30	

¹ Available in the FE-45/X-40 only.

Menus for Playback, Editing, and Printing Functions

In playback mode, settings can be adjusted.

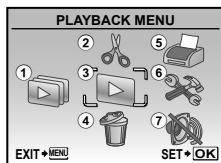
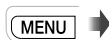

Playback mode top menu

① SLIDESHOW p. 28	(Rotate)..... p. 28	⑥
② EDIT	¹ (Add sound to still	'Same as "Menus for
(Resize) p. 28	images) p. 29	Shooting Functions"
(Crop) p. 28	④ ERASE p. 29	⑦
③ PLAYBACK MENU	⑤ PRINT ORDER..... p. 37	SILENT MODE p. 33
(Protect) p. 28		

¹ Available in the FE-45/X-40 only.



Names of Parts

Camera unit

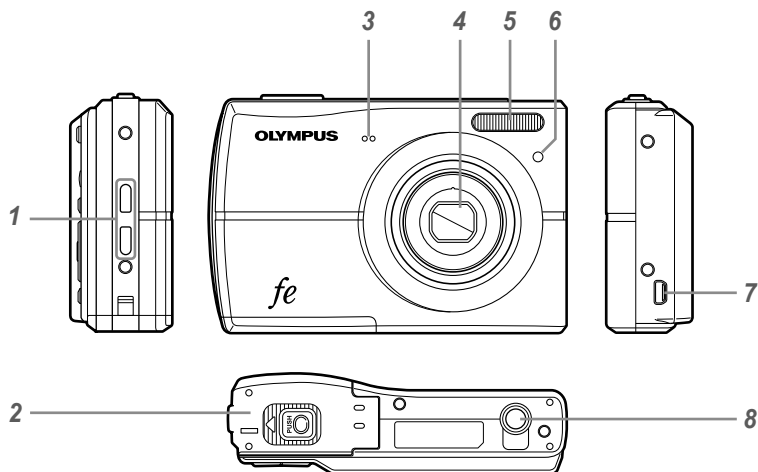

- | | | | | | |
|---|----------------------------------------|-----------|---|----------------------|---------------|
| 1 | Strap eyelet..... | p. 10 | 5 | Flash..... | p. 19 |
| 2 | Battery/card
compartment cover..... | p. 10 | 6 | Self-timer lamp..... | p. 21 |
| 3 | Microphone ^{*1} | p. 25, 29 | 7 | Multi-connector..... | p. 32, 34, 39 |
| 4 | Lens..... | p. 45, 55 | 8 | Tripod socket | |

^{*1} Available in the FE-45/X-40 only.

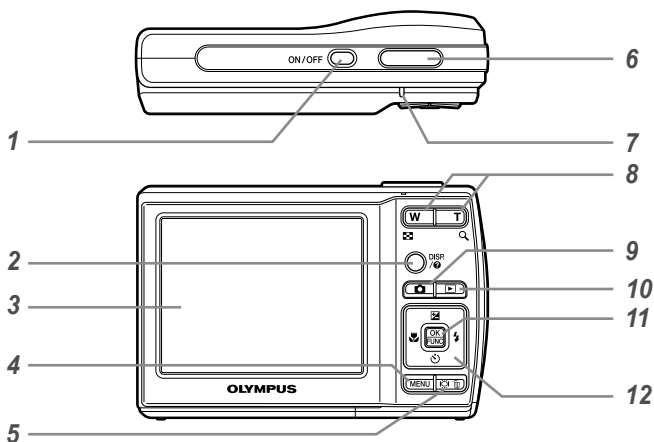

- | | |
|---------------------------------------------------------------------------------------------------------------------------------------------------------------------------------------------------------------------------------------------------------------------------------------------------------------------------------------------------------------------------------------------------------------------------|-------------------------------------------------------------------------------------------------------------------------------------------------------------------------------------------------------------------------------------------------------------------------------------------------------------------------------------------------------------------------------------|
| <p>1 ON/OFF button p. 12</p> <p>2 DISP. button (changing information display/menu guide)..... p. 22, 23/p. 17</p> <p>3 Monitor..... p. 14, 41</p> <p>4 MENU button..... p. 3</p> <p>5 button (backlight boost/erase) p. 21/p. 16, 29</p> <p>6 Shutter button p. 14</p> <p>7 Card access lamp p. 46</p> <p>8 Zoom buttons..... p. 19</p> | <p>9 button (shooting/switching shooting modes) ...p. 17, 18</p> <p>10 button (playback) p. 15</p> <p>11 button (OK/FUNC)..... p. 3, 22</p> <p>12 Arrow pad p. 3, 12</p> <p> button (exposure compensation) p. 20</p> <p> button (macro) p. 20</p> <p> button (self-timer) p. 21</p> <p> button (flash)..... p. 19</p> |
|---------------------------------------------------------------------------------------------------------------------------------------------------------------------------------------------------------------------------------------------------------------------------------------------------------------------------------------------------------------------------------------------------------------------------|-------------------------------------------------------------------------------------------------------------------------------------------------------------------------------------------------------------------------------------------------------------------------------------------------------------------------------------------------------------------------------------|

Shooting mode display

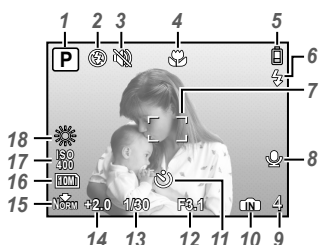

Still image

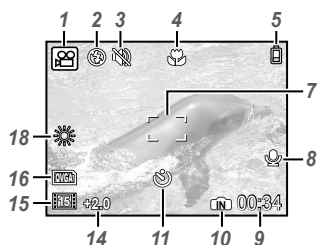

Movie

- | | | | | | |
|----------|--------------------------------------------------------------------|-------------|-----------|-----------------------------|-------|
| 1 | Shooting mode..... | p. 14 | 10 | Current memory..... | p. 46 |
| 2 | Flash mode..... | p. 19 | 11 | Self-timer..... | p. 21 |
| 3 | Silent mode..... | p. 33 | 12 | Aperture value..... | p. 14 |
| 4 | Macro/super macro..... | p. 20 | 13 | Shutter speed..... | p. 14 |
| 5 | Battery check..... | p. 10 | 14 | Exposure compensation..... | p. 20 |
| 6 | Flash standby/camera shake
warning/flash charge..... | p. 19, 41 | 15 | Compression/frame rate..... | p. 24 |
| 7 | AF target mark..... | p. 14 | 16 | Image size..... | p. 24 |
| 8 | Recording with sound ¹ | p. 25 | 17 | ISO..... | p. 25 |
| 9 | Number of storable still pictures/
remaining recording time ... | p. 14/p. 18 | 18 | White balance..... | p. 25 |

¹ Available in the FE-45/X-40 only.

Playback mode display

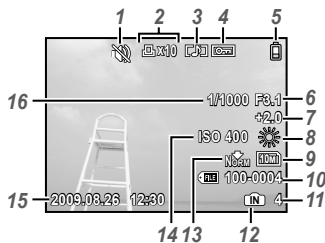

Still image

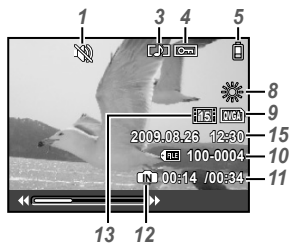

Movie

- | | |
|-------------------------------------------------------------------|---------------------------------------------------------------------------------|
| 1 Silent mode..... p. 33 | 10 File number..... - |
| 2 Print reservations/
number of prints..... p. 37/p. 36 | 11 Frame number/
Elapsed time/total recording time
..... p. 15, 16 |
| 3 Adding sound ^{*1} p. 29 | 12 Current memory..... p. 46 |
| 4 Protect p. 28 | 13 Compression/frame rate p. 24 |
| 5 Battery check..... p. 10 | 14 ISO..... p. 25 |
| 6 Aperture value p. 14 | 15 Date and time p. 12 |
| 7 Exposure compensation p. 20 | 16 Shutter speed p. 14 |
| 8 White balance p. 25 | |
| 9 Image size p. 24 | |

^{*1} Available in the FE-45/X-40 only.

Preparing the Camera

Attaching the camera strap

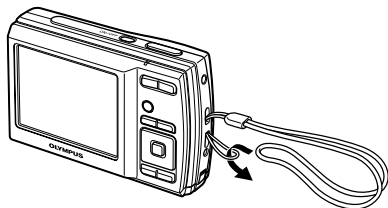

- 1 Pull the strap tight so that it does not come loose.

Loading the batteries and the xD-Picture Card™ (sold separately) into the camera

- 1 Do not insert anything other than an xD-Picture Card or the microSD Attachment into the camera.

1

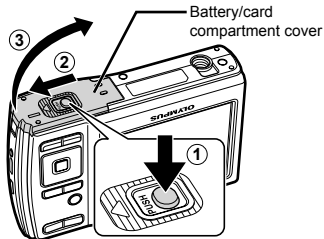

2

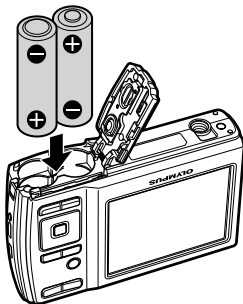

- 1 For the types of batteries that can be used, see "Battery handling precautions" (p. 45). If using rechargeable batteries, charge the batteries.
- 1 Turn off the camera before opening the battery/card compartment cover.

When to replace the batteries

Replace the batteries when the error message shown below appears.

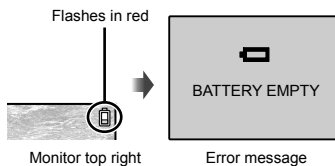

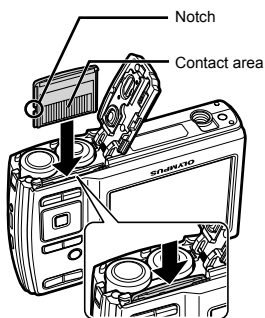
3

- ⚠ Insert the card straight until it clicks into place.
- ⚠ Do not touch the contact area directly.

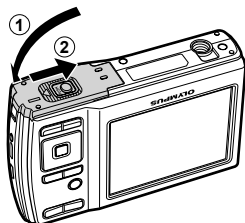
4

- ⚠ This camera allows the user to take pictures using the internal memory even when no xD-Picture Card (sold separately) is inserted. "Using an xD-Picture Card" (p. 46)
- ⚠ "Number of storable pictures (still pictures)/ Continuous recording length (movies) in the internal memory and xD-Picture Card" (p. 47)

To remove the xD-Picture Card

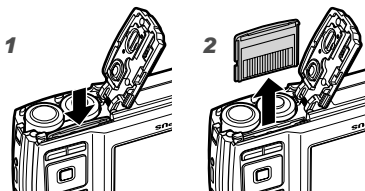

- ⚠ Press the card in until it clicks and comes out slightly, then grab the card and pull it out.

Using the microSD card/ microSDHC card (sold separately)

A microSD card or microSDHC card (hereafter both will be referred to as microSD card) is also compatible with this camera using the microSD Attachment.

- ⚠ "Using the microSD Attachment" (p. 48)

1 Insert the microSD card into the microSD Attachment.

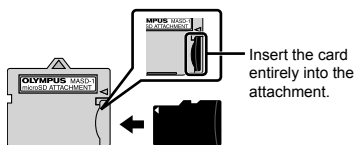

2 Insert the microSD Attachment into the camera.

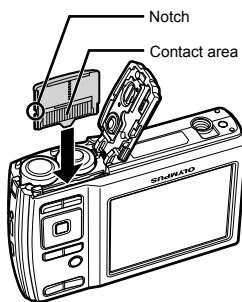

To remove the microSD card



- ⚠ Pull the microSD card straight out.
- ⚠ Do not touch the contact area of the microSD Attachment and/or microSD card.

Arrow pad and operation guide

The symbols displayed on various setting and movie playback screens indicate that the arrow pad be used.

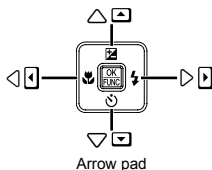
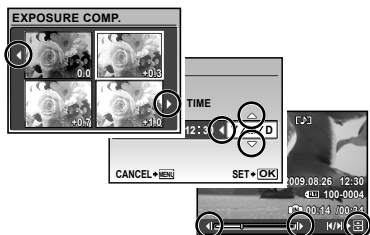

Operation guides displayed at the bottom of the screen indicate that the **MENU** button, button, zoom buttons, or button be used.

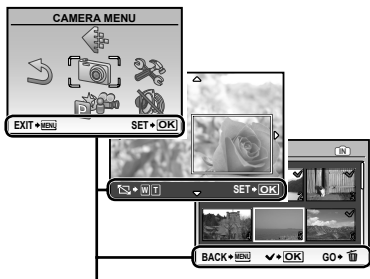

Operation guide

Setting the date and time

The date and time set here are saved to image file names, date prints, and other data.

1 Press the ON/OFF button to turn on the camera.

- The date and time setting screen is displayed when the date and time are not set.

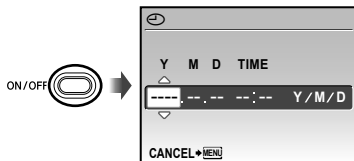

Date and time setting screen

2 Use to select the year for [Y].

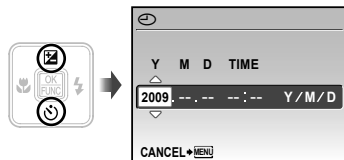

3 Press to save the setting for [Y].

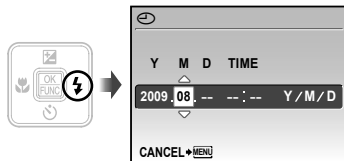



4 As in Steps 2 and 3, use and the button to set [M] (month), [D] (day), [TIME] (hours and minutes), and [Y/M/D] (date order).

- For a more accurate setting, press the button when the time signal hits 00 seconds.
- To change the date and time, adjust the setting from the menu. (Date/time (p. 31))

Changing the display language

The language for the menu and error messages displayed on the monitor is adjustable.

- 1 Press the MENU button, and press   to select  (SETUP).

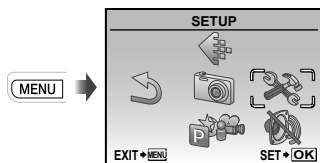

- 2 Press the  button.

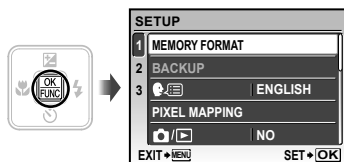

- 3 Use   to select  and press the  button.

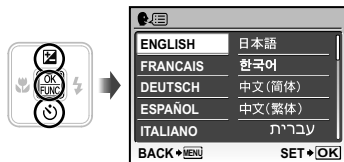

- 4 Use   to select your language and press the  button.

- 5 Press the MENU button.

Shooting, Playback, and Erasing

Shooting with the optimum aperture value and shutter speed (P mode)

In this mode, automatic shooting settings are activated while also allowing changes to a wide range of shooting menu functions such as exposure compensation, white balance, etc. as needed.

1 Press the ON/OFF button to turn on the camera.

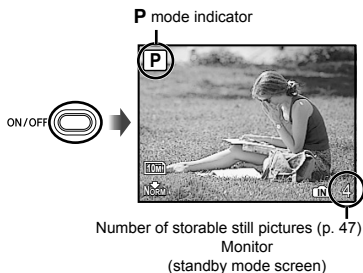

- ! If P mode is not displayed, press the camera button several times to select it.

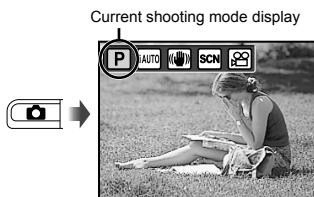

- ! Press the ON/OFF button again to turn off the camera.

2 Hold the camera and compose the shot.

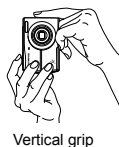
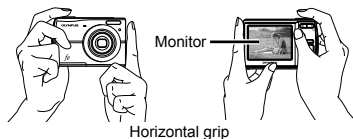

3 Press the shutter button halfway down to focus on the subject.

- When the camera focuses on the subject, the exposure is locked (shutter speed and aperture value are displayed), and the AF target mark changes to green.
- The camera was unable to focus if the AF target mark flashes red. Try focusing again.

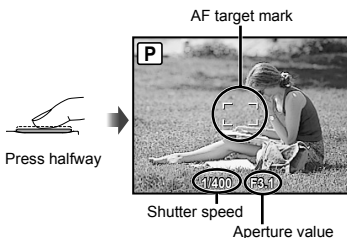

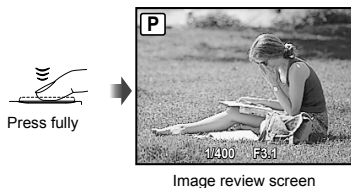

- ! "Focusing" (p. 43)

- 4** To take the picture, gently press the shutter button all the way down while being careful not to shake the camera.



To view images during shooting

Pressing the  button enables playback of images. To return to shooting, either press the  button or press the shutter button halfway down.



To shoot movies

"Shooting movies ( mode)" (p. 18)

Viewing images

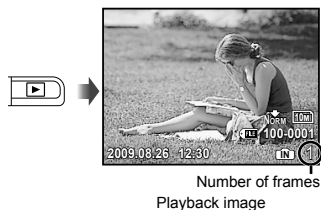
- 1** Press the  button.



- 2** Use    to select an image.

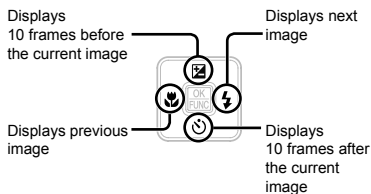

-  The display size of the images can be changed. "Index view and close-up view" (p. 23)

To play back movies

Select a movie, and press the  button.





-  The sound when recording movie can not be played back with this camera.*
To listen to the sound, connect to a TV or PC.

*1  is available only with FE-45/X-40.

Operations during movie playback

Fast-forward: Press and hold down .



Rewind: Press and hold down .

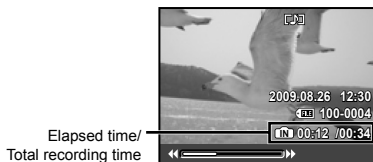

Pause: Press the  button.



During playback

First (last) frame/frame advance:

During pause, press  to display the first frame, and press  to display the last frame.

Press and hold down  to play a movie, and press and hold down  to play a movie in reverse.

Press the  button to resume playback.



During pause

To stop movie playback

Press the **MENU** button.

Erasing images during playback (Single image erase)

- 1 Press the  button when the image to be erased is displayed.



- 2 Press  to select [YES], and press the  button.

 [ERASE] (p. 29)



Using Shooting Modes

- The shooting mode changes in the order of **P**, **iAUTO**, **(SCN)**, **SCN**. Each time the **Q** button is pressed. By switching to any of other shooting modes, most settings in **(SCN)** and **SCN** mode will be changed to the default setting of the respective shooting mode.

Using the best mode for the shooting scene (SCN mode)

- Press the **Q** button a few times to set **SCN**.



- An explanation of the selected mode is displayed while the **Q** button is pressed and held.

- Use **▲**/**▼** to select the best shooting mode for the scene, and press the **Q** button.

Icon indicating the scene mode that is set



- In **SCN** modes, the optimum shooting settings are pre-programmed for specific shooting scenes. For this reason, settings may not be changed in some modes.

Submenu 1	Application
(PORTRAIT)/ (LANDSCAPE)/ (NIGHT SCENE)/ (NIGHT+PORTRAIT)/ (SPORT)/ (INDOOR)/ (CANDLE"/ (SELF PORTRAIT)/ (SUNSET"/ (FIREWORKS"/ (CUISINE)/ (DOCUMENTS)	The camera takes a picture using the optimum settings for the scene conditions.

- When the subject is dark, noise reduction is automatically activated. This approximately doubles the shooting time during which no other pictures can be taken.

Shooting with automatic settings (iAUTO mode)

According to the scene, the camera automatically selects the ideal shooting mode from [PORTRAIT]/[LANDSCAPE]/[NIGHT+PORTRAIT]/[SPORT]/[MACRO]. This is a fully automatic mode that allows the user to take pictures using the best mode for the shooting scene simply by pressing the shutter button. The shooting menu options cannot be specified in **iAUTO** mode.

- Press the **Q** button a few times to set **iAUTO**.

The icon changes depending on the scene that the camera automatically selects.

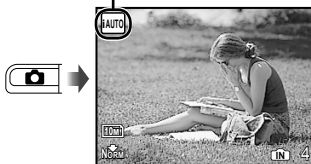



- Press the shutter button halfway down or press the **DISP.** button to check which shooting mode the camera has automatically selected.
- In some cases, the camera may not select the desired shooting mode.
- When the camera cannot identify which is the optimal mode, **P** mode will be selected.

Using the digital image stabilization mode (iAS mode)

This mode enables the user to reduce blur that is caused by camera shake and subject movement.

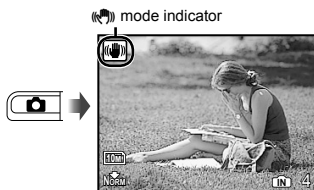
- 1 Press the  button a few times to set .



- ! By switching to any of other shooting modes, most function settings in  mode will change to the default settings of the newly selected mode.

Shooting movies (MOV mode)

- 1 Press the  button a few times to set .

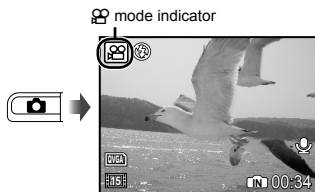

- 2 Press the shutter button halfway to focus on the subject, and gently press the button all the way down to start recording.

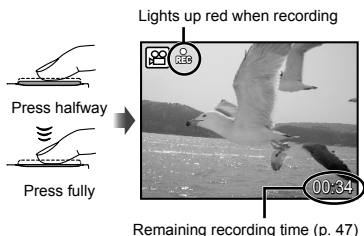

- 3 Gently press the shutter button all the way down to stop recording.

- ! FE-45/X-40 allows you to record movie and sound at the same time. While recording, digital zoom is only available. Set  (movies) (p. 25) to [OFF] when using optical zoom.
- ! FE-35/X-30 allows you to use either optical or digital zoom even during recording movie, but sound cannot be recorded.



Using Shooting Functions

Using the zoom

Pressing the zoom buttons adjusts the shooting range.

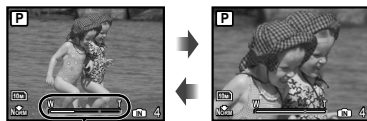
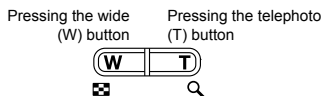

Zoom bar

- ! Optical zoom: 3x, digital zoom: 4x
- ! Use of mode (p. 18) is recommended when shooting with the telephoto zoom.
- ! The zoom bar appearance identifies the status of the digital zoom.

When using optical zoom and digital zoom

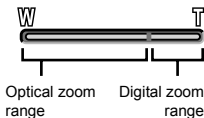

Using the flash

The flash functions can be selected to best match the shooting conditions.

1 Press the button.



2 Use to select the setting option, and press the button to set.

Option	Description
FLASH AUTO	The flash fires automatically in low-light or backlight conditions.
REDEYE	Pre-flashes are emitted to reduce the occurrence of red eye in your photos.
FILL IN	The flash fires regardless of the available light.
FLASH OFF	The flash does not fire.

Adjusting the brightness (Exposure compensation)

The standard brightness (appropriate exposure) set by the camera based on the shooting mode (except for **iAUTO**) can be adjusted brighter or darker to obtain a desired shot.

1 Press the button.



Exposure compensation value

2 Use to select the desired brightness, and press the button.

Shooting closeups (Macro shooting)

This function enables the camera to focus and shoot subjects at close distances.

1 Press the button.

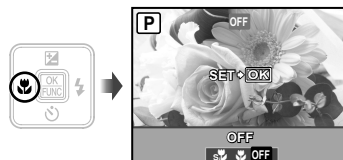

2 Use to select the setting option, and press the button to set.

Option	Description
OFF	Macro mode is deactivated.
MACRO	This enables shooting as close as 10 cm/3.9 in. ¹ (60 cm/23.6 in. ²) to the subject.
SUPER MACRO ³	This enables shooting as close as 5 cm/2.0 in. to the subject.

¹ When the zoom is at the widest (W) position.

² When the zoom is at the most telephoto (T) position.

³ The zoom is automatically fixed.

 The flash (p. 19) and zoom (p. 19) cannot be set during super macro shooting.

Using the self-timer

After the shutter button is pressed all the way down, the picture is taken after a short delay.

1 Press the button.



2 Use to select the desired setting option, and press the button to set.

Option	Description
OFF	The self-timer is deactivated.
ON	The self-timer lamp turns on for approx. 10 seconds, then blinks for approx. 2 seconds, and then the picture is taken.

 Self-timer shooting is automatically canceled after one shot.

To cancel the self-timer after it starts

Press the  button again.

Increasing the brightness of the monitor (Backlight boost)

Press  in shooting mode. The monitor becomes brighter. If there is no operation for 10 seconds, the previous brightness resumes.

Changing the shooting information display

The display of the screen information can be changed to best match the situation, for example, the need for a clear view of the screen or for making a precise composition by using the grid display.

1 Press the DISP. button.

- The displayed shooting information changes in the order shown below each time the button is pressed. "Shooting mode display" (p. 8)

Normal



No information



Grid



Using the FUNC menu

The FUNC menu provides the following menu functions that can be quickly accessed and set.

- [WB] (p. 25)
- [← IMAGE QUALITY] (p. 24)
- [ISO] (p. 25)

1 Press the button.

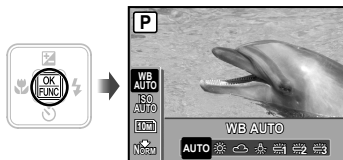

2 Use to select the menu function and to select the desired setting option, and then press the button to set.

Using Playback Features

Index view and close-up view

Index view enables quick selection of a desired image. Close-up view (up to 10x magnification) allows checking of image details.

1 Press the zoom buttons.

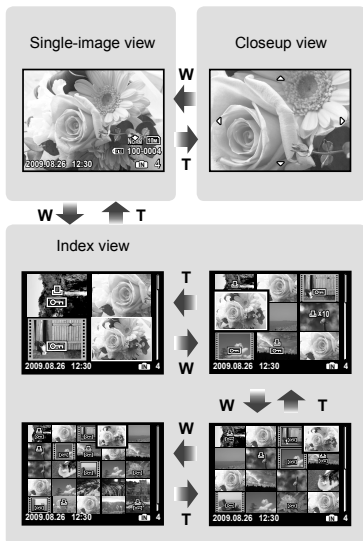
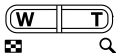

To select an image in index view

Use to select an image, and press the button to display the selected image in single-image view.

To scroll an image in close-up view

Use to move the viewing area.

Changing the image information display

Shooting information settings displayed on the screen can be changed.



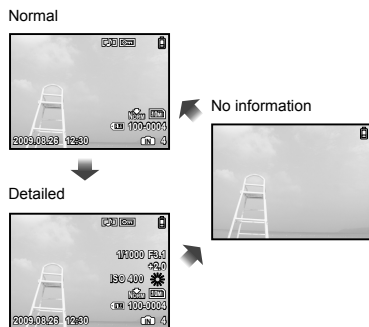

1 Press the DISP. button.

- The displayed image information changes in the order shown below each time the button is pressed.



Menus for Shooting Functions

In shooting mode, settings can be adjusted.

-   indicates the mode in which the function can be set.
-  The default settings of the function are highlighted in .

Selecting the appropriate image quality for your application [IMAGE QUALITY]





 IMAGE QUALITY

 P i AUTO  SCN 

Still pictures

Submenu 1	Submenu 2	Application
IMAGE SIZE	10M (3648×2736)	Suitable for printing pictures larger than A3 (11×17 in.).
	5M (2560×1920)	Suitable for printing A4 (8.5×11 in.) pictures.
	3M (2048×1536)	Suitable for printing pictures up to A4 (8.5×11 in.).
	2M (1600×1200)	Suitable for printing A5 (5×7 in.) pictures.
	1M (1280×960)	Suitable for printing pictures at postcard size.
	VGA (640×480)	Suitable for viewing pictures on a TV or using pictures in emails and on websites.
	16:9 (1920×1080)	Suitable for playing pictures on a wide screen TV.
COMPRESSION	FINE	Shooting at high quality.
	NORMAL	Shooting at normal quality.

Movies

Submenu 1	Submenu 2	Application
IMAGE SIZE	VGA (640×480) / QVGA (320×240)	Select the image quality based on the image size and frame rate. Higher frame rates provides smoother movie images.
FRAME RATE	 30  30fps ¹ /  15  15fps ¹	

¹ frames per second

-  "Number of storable pictures (still pictures)/Continuous recording length (movies) in the internal memory and xD-picture Card" (p. 47)

Adjusting to a natural color scheme [WB]

CAMERA MENU ► WB



Submenu 2	Application
AUTO	The camera automatically adjusts the white balance according to the shooting scene.
	For shooting outdoors under a clear sky
	For shooting outdoors under a cloudy sky
	For shooting under tungsten lighting
	For shooting under daylight fluorescent lighting (household lighting, etc.)
	For shooting under neutral fluorescent lighting (desk lamps, etc.)
	For shooting under white fluorescent lighting (offices, etc.)

Selecting the ISO sensitivity [ISO]

CAMERA MENU ► ISO



- ! Abbreviation for the International Organization for Standardization. ISO standards specify the sensitivity for digital cameras and film, thus codes such as "ISO 100" are used to represent sensitivity.
- ! In the ISO setting, although smaller values result in less sensitivity, sharp images can be taken under fully lit conditions. Larger values result in higher sensitivity, and images can be taken at fast shutter speeds even under low light conditions. However, high sensitivity introduces noise into the resulting picture, which may give it a grainy appearance.

Submenu 2	Application
AUTO	The camera automatically adjusts the sensitivity according to the shooting scene.
100/200/400/ 800/1600	The value of the ISO sensitivity is fixed.

Recording sound when shooting still images [M] (FE-45/X-40)

CAMERA MENU ►



Submenu 2	Application
OFF	No sound is recorded.
ON	The camera automatically starts recording sound for approx. 4 seconds after a picture is taken. This is useful for recording notes or comments about the picture.

- ! When recording, aim the microphone (p. 6) at the source of the sound you want to record.
- ! The sound when recorded in still REC can not be played back with this camera. To listen to the sound, connect to a TV or PC.

Selecting sound setting for movies [M] (FE-45/X-40)

CAMERA MENU ►



Submenu 2	Application
OFF	No sound is recorded.
ON	Sound is recorded.







- ! When set to [ON], only the digital zoom can be used during movie recording. To record the movie with the optical zoom, set [M] (movies) to [OFF].
- ! The sound when recorded in movie REC cannot be played back with this camera. To listen to the sound, connect to a TV or PC.

Creating panoramic images [PANORAMA]





 CAMERA MENU ► PANORAMA

 P  SCN

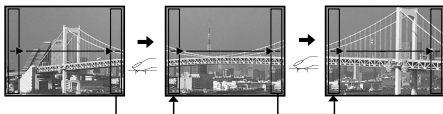
Panorama shooting lets you create a panoramic picture, using the OLYMPUS Master 2 software on the provided CD-ROM.

-  The focus, exposure (p. 20), zoom position (p. 19), and [WB] (p. 25) are locked at the first frame.
-  The flash (p. 19) is fixed to  (FLASH OFF) mode.
- ① Use     to select the direction that the frames are combined.
- ② Press the shutter button to take the first frame, and then compose the second shot.
 - The part of the previous picture where it will be joined to the next picture does not remain in the frame. You have to remember what the part in the frame looked like and take the next picture so it overlaps.



- ③ Repeat Step ② until the number of desired frames is taken, and then press the  button when finished.
-  When the  mark is displayed, you cannot continue shooting any further. Panorama shooting is possible for up to 10 frames.
-  Refer to the OLYMPUS Master 2 help guide for details on how to make panorama images.

Selecting the focusing on a face [FACE DETECT]

 CAMERA MENU ► FACE DETECT

 P  SCN

Submenu 2	Application
OFF	The camera does not focus on a face.
ON ¹⁾	This is used for taking pictures of people. (The camera automatically detects a face and a frame is displayed.)

¹⁾ For some subjects, the frame may not appear or may take some time to appear.

Switching the shooting modes [] SWITCH SHOOTING MODES]

SWITCH SHOOTING MODES

: P iAUTO

Submenu 1	Application
P	Shooting with optimum aperture value and shutter speed (p. 14).
iAUTO	Shooting with automatic settings (p. 17).
DIS MODE	Using the digital image stabilization mode (p. 18).
SCN	Using the best mode for the shooting scene (p. 17).
MOVIE	Shooting movies (p. 18).

Restoring the shooting functions to the default settings [↶] RESET]

RESET

: P iAUTO

Submenu 1	Application
YES	Restores the following menu functions to the default settings. <ul style="list-style-type: none"> • Flash (p. 19) • Exposure compensation (p. 20) • Macro (p. 20) • Self-timer (p. 21) • [] IMAGE QUALITY] (p. 24) • [SCN] (p. 17) • Shooting information display (p. 22) • Menu functions in [] CAMERA MENU] (p. 24 to 27)
NO	The current settings will not be changed.

Menus for Playback, Editing, and Printing Functions

Settings can be adjusted during image playback.

Playing back pictures automatically [SLIDESHOW]

[SLIDESHOW]

To start a slideshow

After pressing the [] button, the slideshow starts. To stop the slideshow, press the [] button or the MENU button.

- ! The sound when recorded in slideshow can not be played back with this camera. To listen to the sound, connect to a TV or PC.

Changing the image size []

[EDIT] []

Submenu 2	Application
[VGA] 640 × 480	This saves a high-resolution image as a separate image with a smaller size for use in e-mail attachments and other applications.
[QVGA] 320 × 240	

Cropping image []

[EDIT] []

- Use [] to select an image, and press the [] button.
- Use the zoom buttons to select the size of the cropping frame, and use [] [] [] [] to move the frame.

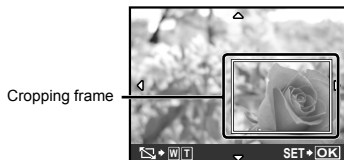

- Press the [] button.
 - The edited image will be saved as a separate image.

Protecting images [ON]

[PLAYBACK MENU] [ON]

- ! Protected images cannot be erased by [ERASE] (p. 16), [SEL. IMAGE], or [ALL ERASE] (p. 29), but all images are erased by [MEMORY FORMAT]/[FORMAT] (p. 30).

Submenu 2	Application
OFF	Images can be erased.
ON	Images are protected so that they cannot be erased except by formatting of the internal memory/card.

- Use [] to select an image.
- Use [] [] to select [ON].
- If necessary, repeat Steps ① and ② to protect other images, and press the [] button.

Rotating images []

[PLAYBACK MENU] []

Submenu 2	Application
[] +90°	The image is rotated 90° clockwise.
[] 0°	The image is not rotated.
[] -90°	The image is rotated 90° counter-clockwise.

- Use [] to select an image.
 - Use [] [] to select the rotation direction.
 - If necessary, repeat Steps ① and ② to make settings for other images, and press the [] button.
- ! The new picture orientations will be saved even after the power is turned off.

Adding sound to still images [U] (FE-45/X-40)

▶ PLAYBACK MENU ▶ U

Submenu 2	Application
YES	The camera adds (records) sound for approx. 4 seconds while playing back the image. This is useful for recording notes or comments about the image.
NO	No sound is recorded.

- Use to select an image, and press the button.
- Aim the microphone towards the sound source.

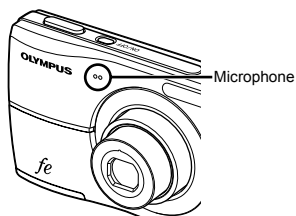

- Use to select [YES], and press the button.
 - Recording starts.

Erasing images [U] ERASE

ERASE

Submenu 1	Application
SEL. IMAGE	Images are individually selected and erased.
ALL ERASE	All images in the internal memory or card will be erased.

- When erasing pictures in the internal memory, do not insert the card into the camera.
- When erasing pictures from the card, insert a card into the camera in advance.

To individually select and erase images [SEL. IMAGE]

- Use to select [SEL. IMAGE], and press the button.
- Use to select the image to be erased, and press the button to add a mark to the image.



- Repeat Step 2 to select the images to be erased, and then press the button to erase the selected images.
- Use to select [YES], and press the button.
 - The images with a mark are erased.

To erase all images [ALL ERASE]

- Use to select [ALL ERASE], and press the button.
- Use to select [YES], and press the button.

Saving print settings to the image data [PRINT ORDER]



PRINT ORDER

- “Print Reservations (DPOF)” (p. 37)
- Print reservation can be set only for still images that are recorded to the card.

Menus for Other Camera Settings

Erasing data completely [MEMORY FORMAT]/[FORMAT]

 SETUP ► MEMORY FORMAT/FORMAT

-  Before formatting, check that no important data is left in the internal memory or card.
-  Non-Olympus cards and cards that have been formatted by a computer must be formatted with this camera before use.

Submenu 2	Application
YES	Completely erases the image data in the internal memory ^{*1} or card (including protected images).
NO	Cancels formatting.

^{*1} Be sure to remove the card before formatting the internal memory.

Copying images in the internal memory to the card [BACKUP]

 SETUP ► BACKUP

Submenu 2	Application
YES	Backs up image data in the internal memory to the card.
NO	Cancels the backup.

-  It takes some time to back up data. Check that the battery has sufficient power before starting the backup.

Changing the display language [

 SETUP ► 



-  "Changing the display language" (p. 13)

Submenu 2	Application
Languages ^{*1}	The language for the menus and error messages displayed on the monitor is selected.

^{*1} The available languages vary depending on the country and/or region where the camera was purchased.

Adjusting the CCD and the image processing function [PIXEL MAPPING]

 SETUP ► PIXEL MAPPING

-  This function has already been adjusted at factory shipping, and no adjustment is needed right after purchase. Approximately once a year is recommended.
-  For best results, wait at least one minute after taking or viewing pictures before performing pixel mapping. If the camera is turned off during pixel mapping, be sure to perform it again.



To adjust the CCD and the image processing function

Press the  button when [START] (Submenu 2) is displayed.

- The camera checks and adjusts the CCD and the image processing function at the same time.

Turning on the camera with the or button [/▶]

 SETUP ▶ /▶

Submenu 2	Application
YES	Pressing  turns on the camera and starts the camera in the shooting mode. Pressing  turns on the camera and starts the camera in the playback mode.
NO	The power is not turned on. To turn on the camera, press the ON/OFF button.

Saving the mode when the camera is turned off [SAVE SETTINGS]



 SETUP ▶ SAVE SETTINGS

Submenu 2	Application
YES	The shooting mode is saved when the camera is turned off and is reactivated the next time the camera is turned on.
NO	The shooting mode is set to P mode when the camera is turned on.

 When set to [YES], the following settings will be saved.

- Flash
- Macro
- Exposure compensation
- White balance
- ISO
- ¹ (Still images/Movies)
- FACE DETECT

¹ Available in the FE-45/X-40 only.

 When set to [NO], all shooting settings, except for **P** mode, [ IMAGE QUALITY], and the selected **SCN** mode, return to default settings when the camera is turned off.

Selecting the menu screen color and background [MENU COLOR]

 SETUP ▶ MENU COLOR

Submenu 2	Application
NORMAL/ COLOR 1/ COLOR 2/ COLOR 3	Selects the menu screen color or background image according to your preference.

Setting the operation sound [BEEP]

 SETUP ▶ BEEP

Submenu 2	Application
OFF/ON	Turn off or on the operating sound/warning sound of the camera buttons.

Adjusting the brightness of the monitor []

 SETUP ▶ 



Submenu 2	Application
BRIGHT/ NORMAL	Selects the monitor brightness depending on the surrounding brightness.

Setting the date and time []

 SETUP ▶ 

 “Setting the date and time” (p. 12)

To select the date display order

- Press  after setting Minute, and use /  to select the date display order.

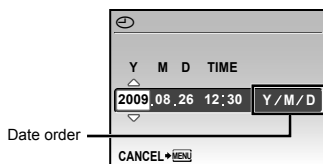

Selecting a video signal system to match your TV [VIDEO OUT]

SETUP ► VIDEO OUT

- ! The TV video signal system varies depending on the countries and regions. Before viewing camera images on your TV, select the video output according to your TV's video signal type.

Submenu 2	Application
NTSC	Connecting the camera to a TV in North America, Taiwan, Korea, Japan, and so on.
PAL	Connecting the camera to a TV in European countries, China, and so on.

- ! The factory default settings differ according to the region where the camera is sold.

To play back camera images on a TV



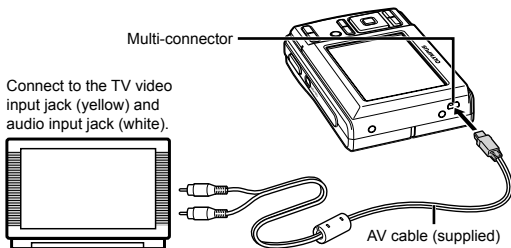

- ① Connect the TV and camera.

FE-45/X-40:

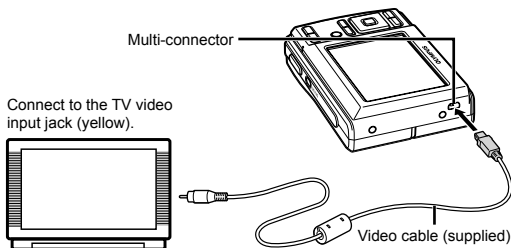

FE-35/X-30:



- ② Use the camera to select the same video signal system as the one of connected TV ([NTSC]/[PAL]).
- ③ Turn on the TV, and change "INPUT" to "VIDEO (an input jack connected to the camera)."
- ! For details on changing the input source of the TV, refer to the TV's instruction manual.
- ④ Press the  button, and use     to select the image for playback.
- ! Depending on the TV's settings, the displayed images and information may become cropped.

Saving battery power between shots **[POWER SAVE]**

 SETUP ► POWER SAVE

Submenu 2	Application
OFF	Cancels [POWER SAVE].
ON	When the camera is not being used for approx. 10 seconds, the monitor automatically turns off to save battery power.

To resume standby mode

Press any button.

Turning off the camera sounds **[SILENT MODE]**

 SILENT MODE

Submenu 1	Application
OFF	Button operation sound/warning sound are not muted.
ON	The electronic sounds (button operation sound, warning sound) are muted.

 [BEEP] (p. 31)

Printing

Direct printing (PictBridge¹)

By connecting the camera to a PictBridge-compatible printer, you can print images directly without using a computer.

To find out if your printer supports PictBridge, refer to the printer's instruction manual.

¹ PictBridge is a standard for connecting digital cameras and printers of different makers and printing out pictures directly.

- ! The printing modes, paper sizes, and other parameters that can be set with the camera vary depending on the printer that is used. For details, refer to the printer's instruction manual.
- ! For details on the available paper types, loading paper, and installing ink cassettes, refer to the printer's instruction manual.

Printing images at the printer's standard settings [EASY PRINT]

1 Display the image to be printed on the monitor.

- ! "Viewing images" (p. 15)
- ! Printing can also be started when the camera is turned off. After performing Step 2, use \leftarrow / \rightarrow to select [EASY PRINT], press the $\left[\text{OK}\right]$ button. Use \leftarrow / \rightarrow to select an image, and press the $\left[\text{OK}\right]$ button.

2 Turn on the printer, and then connect the printer and camera.

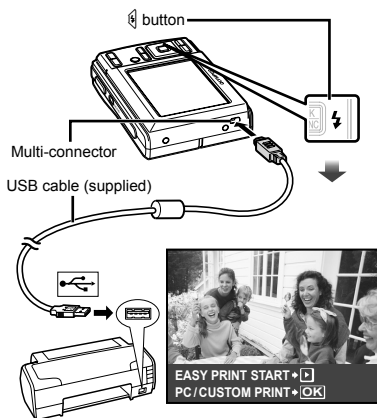

3 Press the $\left[\text{button}\right]$ to start printing.

4 To print another image, use \leftarrow / \rightarrow to select an image, and press the $\left[\text{OK}\right]$ button.

To exit printing

After a selected image is displayed on the screen, disconnect the USB cable from the camera and printer.



Changing the printer's settings for printing [CUSTOM PRINT]

- 1 Follow Steps 1 and 2 for [EASY PRINT] (p. 34), and press the button.

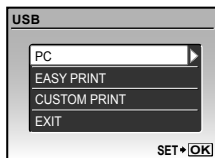

- 2 Use to select [CUSTOM PRINT], and press the button.

- 3 Use to select the print mode, and press the button.

Submenu 2	Application
PRINT	This prints the image selected in Step 6.
ALL PRINT	This prints all images stored in the internal memory or card.
MULTI PRINT	This prints one image in a multiple layout format.
ALL INDEX	This prints an index of all images stored in the internal memory or card.
PRINT ORDER ¹	This prints images based on the print reservation data on the card.

¹ [PRINT ORDER] is available only when print reservations have been made. "Print Reservations (DPOF)" (p. 37)

- 4 Use to select [SIZE] (Submenu 3), and press .

- ! If the [PRINTPAPER] screen is not displayed, the [SIZE], [BORDERLESS], and [PICS/SHEET] are set to the printer's standard.

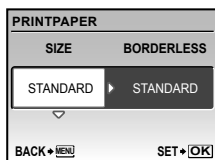

- 5 Use to select the [BORDERLESS] or [PICS/SHEET] settings, and press the .

Submenu 4	Application
OFF/ON ¹	The image is printed with a border around it ([OFF]). The image is printed to fill the entire paper ([ON]).
(The number of images per sheet varies depending on the printer.)	The number of images per sheet ([PICS/SHEET]) is selectable only when [MULTI PRINT] is selected in Step 3.

¹ The available settings for [BORDERLESS] vary depending on the printer.

- ! If [STANDARD] is selected in Steps 4 and 5, the image is printed at the printer's standard settings.



- 6 Use to select an image.

- 7 Press to make a print reservation for the current image. Press to make the detailed printer settings for the current image.

To make the detailed printer settings

- 1 Use to select the setting, and press the .

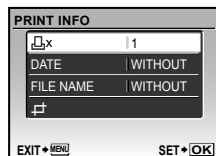

Submenu 5	Submenu 6	Application
	0 to 10	This selects the number of prints.
DATE	WITH/ WITHOUT	Selecting [WITH] prints the images with the date. Selecting [WITHOUT] prints the images without the date.
FILE NAME	WITH/ WITHOUT	Selecting [WITH] prints the file name on the image. Selecting [WITHOUT] does not print any file name on the image.
	(Proceeds to the setting screen.)	This selects a portion of the image for printing.

To crop an image []

- Use the zoom buttons to select the size of the cropping frame, use to move the frame, and then press the button.



- Use to select [OK], and press the button.



- If necessary, repeat Steps 6 and 7 to select the image to be printed, make the detailed settings, and set [SINGLEPRINT].

- Press the button.

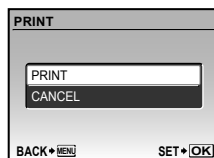

- Use to select [PRINT], and press the button.

- Printing starts.
- When [OPTION SET] is selected in [ALL PRINT] mode, [PRINT INFO] screen is displayed.
- When printing is finished, the [PRINT MODE SELECT] screen is displayed.

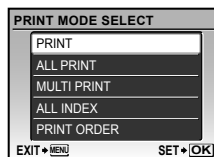

To cancel printing

- When [TRANSFERRING] is displayed, press the button, use to select [CANCEL], and then press the button again.

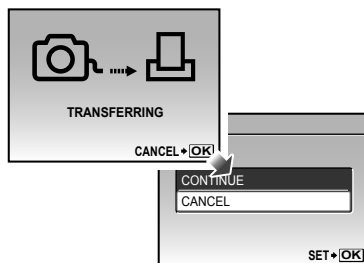

- Press the MENU button.

- When the message [REMOVE USB CABLE] is displayed, disconnect the USB cable from the camera and printer.

Print Reservations (DPOF¹)

In print reservations, the number of prints and date imprint option are saved in the image on the card. This enables easy printing at a printer or print shop supporting DPOF by using only the print reservations on the card without a computer or a camera.

¹ DPOF is a standard for storing automatic printout information from digital cameras.

- Print reservations can be set only for the images stored on the card. Insert a card with recorded images before making print reservations.
- DPOF reservations set by another DPOF device cannot be changed by this camera. Make changes using the original device. Making new DPOF reservations with this camera will erase the reservations made by the other device.
- DPOF print reservations can be made for up to 999 images per card.

Single-frame print reservations []

- Press the [] button, and then press the MENU button to display the top menu.
- Use [] to select [] PRINT ORDER], and press the [] button.

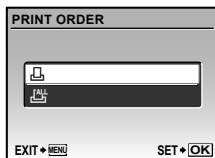

- Use [] to select [], and press the [] button.

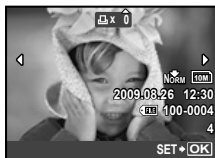

- Use [] to select the image for print reservation. Use [] to select the quantity. Press the [] button.



- Use [] to select the [] (date print) screen option, and press the [] button.

Submenu 2	Application
NO	This prints the image only.
DATE	This prints the image with the shooting date.
TIME	This prints the image with the shooting time.



- Use [] to select [SET], and press the [] button.

Reserving one print each of all images on the card [ALL]

- 1 Follow Steps 1 and 2 in [] (p. 37).
- 2 Use to select [ALL], and press the button.
- 3 Follow Steps 5 and 6 in [].

Resetting all print reservation data

- 1 Press the button, and then press the MENU button to display the top menu.
- 2 Use to select [PRINT ORDER], and press the button.
- 3 Select either [] or [ALL], and press the button.

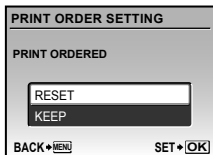

- 4 Use to select [RESET], and press the button.

Resetting the print reservation data for selected images

- 1 Follow Steps 1 and 2 of “Resetting all print reservation data” (p. 38).
- 2 Use to select [], and press the button.
- 3 Use to select [KEEP] and press the button.
- 4 Use to select the image with the print reservation you want to cancel. Use to set the print quantity to “0”.
- 5 If necessary, repeat Step 4, and then press the button when finished.
- 6 Use to select the [] (date print) screen option, and press the button.
 - The settings are applied to the remaining images with the print reservation data.
- 7 Use to select [SET], and press the button.

Using OLYMPUS Master 2

System requirements and installation of OLYMPUS Master 2

Install the OLYMPUS Master 2 software by referring to the included installation guide.

Connecting the camera to a computer

1 Make sure the camera is turned off.

- The monitor is off.
- The lens is retracted.

2 Connect the camera to a computer.

- The camera automatically turns on.

Multi-connector

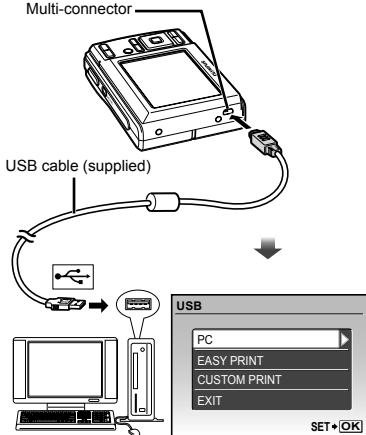

- ! Locate the position of the USB port by referring to your computer's instructions manual.

3 Use \leftarrow \rightarrow to select [PC], and press the $\left[\text{OK}\right]$ button.

- The computer automatically detects the camera as a new device on the first connection.

Windows

After the computer detects the camera, a message indicating setup completion appears. Confirm the message and click "OK". The camera is recognized as a removable disk.

Macintosh

If iPhoto has started, exit iPhoto and start OLYMPUS Master 2.

- ! While the camera is connected to the computer, shooting functions are disabled.
- ! Connecting the camera to a computer via a USB hub may cause unstable operation.
- ! When [MTP] is set for the submenu that appears by pressing $\left[\text{MTP}\right]$ after selecting [PC] in Step 3, images cannot be transferred to a computer using OLYMPUS Master 2.

Starting OLYMPUS Master 2

1 Double-click the OLYMPUS Master 2 icon.

Windows

appears on the desk top.

Macintosh

appears in the OLYMPUS Master 2 folder.

- Browse window appears after starting the software.
- ! When you start OLYMPUS Master 2 for the first time after installation, "Default Settings" and "Registration" screen appear. Follow the instructions on the screen.

Operating OLYMPUS Master 2

When OLYMPUS Master 2 is started, the Quick Start Guide appears with step-by-step instructions for common tasks. When the Quick Start Guide is not displayed, click  in the tool bar to show the Guide.



For details on the operation, refer to the help guide of the software.



Transferring and saving images without using OLYMPUS Master 2

This camera is compatible with the USB Mass Storage Class. You can transfer and save the image data on your computer while the camera and the computer are connected.

System requirements

Windows : Windows 2000 Professional/
XP Home Edition/
XP Professional/Vista

Macintosh : Mac OS X v10.3 or later

-  On a computer running Windows Vista, if [MTP] is set for the submenu that appears by pressing  after selecting [PC] in Step 3 of "Connecting the camera to a computer" (p. 39), Windows Photo Gallery will become available.
-  Even if a computer has USB ports, proper operation is not guaranteed in the following cases.
 - computers with USB ports installed using an expansion card, etc.
 - computers without a factory-installed OS and home-built computers

Usage Tips

If the camera does not work as intended, or if an error message is displayed on the screen, and you are unsure of what to do, refer to the information below to fix the problem(s).

Troubleshooting

Battery

"The camera does not work even when batteries are installed".

- Insert new or recharged batteries in the correct direction.

"Loading the batteries and the xD-Picture Card™ (sold separately) into the camera" (p. 10)

- Battery performance may have been reduced temporarily due to low temperature. Take the batteries out of the camera, and warm them by putting them in your pocket for a while.



Card/Internal memory

"An error message is displayed".

"Error message" (p. 42)

Shutter button

"No picture is taken when the shutter button is pressed".

- Cancel sleep mode.
To save battery power, the camera automatically goes into sleep mode and the monitor turns off if there is no operation for 3 minutes when the camera is turned on. No picture is taken even if the shutter button is fully pressed in this mode. Operate the zoom buttons or other buttons to restore the camera from sleep mode before taking a picture. If the camera is left for another 12 minutes, it automatically turns off. Press the ON/OFF button to turn the camera on.
- Press the  button to set a shooting mode.
- Wait until  (flash charge) stops blinking before taking pictures.

Monitor

"Difficult to see".

- Condensation¹ may have occurred. Turn off the power, and wait for the camera body to become acclimated to the surrounding temperature and dry out before taking pictures.

¹ Dew drops can form in the camera when it is suddenly taken from a cold location into a warm, humid room.

"Vertical lines appear on the screen".

- This condition may occur when the camera is pointed at an extremely bright subject under a clear sky and so on. The lines do not appear, however, in the final image.

"The light is caught in the picture".

- Shooting with flash in dark situations results in an image with many flash reflections on dust in the air.

Date and time function

"Date and time settings return to the default setting".

- If the batteries are removed and left out of the camera for about a day², the date and time settings return to the default setting, and must be reset.

² The time until the date and time settings return to the default setting varies depending on how long the batteries have been loaded.

"Setting the date and time" (p. 12)

Miscellaneous





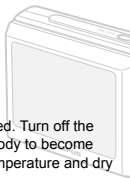









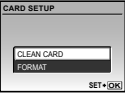







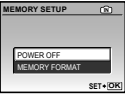

"The camera makes a noise when taking pictures".









- The camera may activate the lens and make a noise even if no operation is performed. This is because the camera automatically performs actions of auto focus as far as it is ready to shoot.



Error message

- ! When one of the messages below is received on the monitor, check the corrective action.

Error message	Corrective action
 CARD ERROR	Card problem Insert a new card.
 WRITE PROTECT	Card problem Use a computer to cancel the read-only setting.
 MEMORY FULL	Internal memory problem <ul style="list-style-type: none"> Insert a card. Erase unwanted images.¹
 CARD FULL	Card problem <ul style="list-style-type: none"> Replace the card. Erase unwanted images.¹
 CARD SETUP 	Card problem <ul style="list-style-type: none"> Use   to select [CLEAN CARD], and press the  button. Take out the card, wipe the contact area (p. 46) with a soft, dry cloth, and then load the card again. Use   to select [FORMAT], and press the  button. Next, use   to select [YES], and press the  button.²
 MEMORY SETUP 	Internal memory problem Use   to select [MEMORY FORMAT], and press the  button. Next, use   to select [YES], and press the  button. ²
 NO PICTURE	Internal memory/Card problem Take pictures before viewing them.
 PICTURE ERROR	Problem with selected image Use photo retouch software, etc. to view the image on a computer. If the image still cannot be viewed, the image file is corrupted.
 THE IMAGE CANNOT BE EDITED	Problem with selected image Use photo retouch software, etc. to edit the image on a computer.

 CARD-COVER OPEN	Operation problem Close the battery/card compartment cover.
 BATTERY EMPTY	Battery problem <ul style="list-style-type: none"> Insert new batteries. If using rechargeable batteries, charge the batteries.
 NO CONNECTION	Connection problem Connect the camera and computer or printer correctly.
 NO PAPER	Printer problem Load paper into the printer.
 NO INK	Printer problem Refill the ink in the printer.
 JAMMED	Printer problem Remove the jammed paper.
 SETTINGS CHANGED ³	Printer problem Return to the status where the printer can be used.
 PRINT ERROR	Printer problem Turn off the camera and printer, check the printer for any problems, and then turn the power on again.
 CANNOT PRINT ⁴	Problem with selected image Use a computer to print.

¹ Before erasing important images, download them to a computer.

² All data will be erased.

³ This is displayed, for instance, when the printer's paper tray has been removed. Do not operate the printer while making the print settings on the camera.

⁴ This camera may be unable to print images taken by other cameras.

Shooting tips

When you are unsure of how to take a picture that you envision, refer to the information below.

Focusing

“Focusing on the subject”

- **Taking a picture of a subject not in the center of the screen**

After focusing on an object at the same distance as the subject, compose the shot, and take the picture.

Pressing the shutter button halfway (p. 14)

- **Taking a picture of subjects where autofocus is difficult**

In the following cases, after focusing on an object (by pressing the shutter button halfway down) with high contrast at the same distance as the subject, compose the shot, and take the picture.

Subjects with low contrast



When extremely bright objects appear in the center of the screen

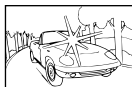

Object with no vertical lines¹

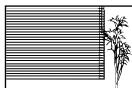

¹ It is also effective to compose the shot by holding the camera vertically to focus, and then returning to the horizontal position to take the picture.

When objects are at different distances



Fast-moving object

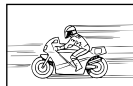

The subject is not in the center of the frame





Camera shake



“Taking pictures without camera shake”

- **Taking pictures using  mode (p. 18).**

- **Select  (SPORT) in SCN mode (p. 17)**

The  (SPORT) mode uses a fast shutter speed and can reduce the blur incurred by a moving subject.

- **Taking pictures at a high ISO sensitivity.**

If a high ISO sensitivity is selected, pictures can be taken at a high shutter speed even at locations where a flash cannot be used.

[ISO] (p. 25)

Exposure (brightness)



“Taking pictures with the right brightness”

- **Taking pictures using [FACE DETECT] (p. 26)**

Appropriate exposure is obtained for a face against backlight, and the face is brightened.

- **Taking pictures using [FILL IN] (p. 19) flash**

A subject against backlight is brightened.

- **Taking pictures using exposure compensation (p. 20)**

Adjust the brightness while viewing the screen for taking the picture. Normally, taking pictures of white subjects (such as snow) results in images that are darker than the actual subject. Use the  button to adjust in the positive (+) direction to express whites as they appear. When taking pictures of black subjects, on the other hand, it is effective to adjust in the negative (-) direction.

“Taking pictures with colors at the same shade as they appear”

- **Taking pictures by selecting [WB] (p. 25)**

Best results in most environments can normally be obtained with the AUTO setting, but for some subjects, you should try experimenting with different settings. (This is especially true for sunshade under a clear sky, mixed natural and artificial light settings, and so on.)

- **Taking pictures using [FILL IN] (p. 19) flash**

Use of the flash is also effective for shooting under fluorescent and other artificial lighting.

**“Taking sharper pictures”**

- **Taking pictures with the optical zoom**

Avoid using digital zoom (p. 19) to take pictures.

- **Taking pictures at a low ISO sensitivity**

If the picture is taken with a high ISO sensitivity, noise (small colored spots and color unevenness that were not in the original image) can occur, and the image can appear grainy. The resulting image is grainier than with low ISO sensitivity as well.

[ISO] (p. 25)

**“Making batteries last longer”**

- **Avoid any of the following operations when not actually taking pictures because they deplete the battery power.**
 - Repeatedly pressing the shutter button halfway
 - Repeatedly using the zoom
- **Set [POWER SAVE] (p. 33) to [ON].**

**“Playing images in the internal memory and card”**

- **Remove the card when playing pictures in the internal memory.**
 - “Loading the batteries and the xD-Picture card™ (sold separately) into the camera” (p. 10)
 - “Using the microSD card/microSDHC card (sold separately)” (p. 11)

**“Erasing the sound recorded to a still image” (FE-45/X-40)**

- **Record over the sound with silence when playing back the image**

“Adding sound to still images [🎤]” (p. 29)

Appendix

Camera care

Exterior

- Wipe gently with a soft cloth. If the camera is very dirty, soak the cloth in mild soapy water and wring well. Wipe the camera with the damp cloth and then dry it with a dry cloth. If you have used the camera at the beach, use a cloth soaked in clean water and wrung well.

Monitor

- Wipe gently with a soft cloth.

Lens

- Blow dust off the lens with a commercial blower, then wipe gently with a lens cleaner.
 - ! Do not use strong solvents such as benzene or alcohol, or chemically treated cloth.
 - ! Mold may form on the lens surface if the lens is left dirty.

Storage

- When storing the camera for extended periods, remove the battery and card, and keep in a cool, dry place that is well ventilated.
- Periodically insert the battery and test the camera functions.
 - ! Avoid leaving the camera in places where chemical products are handled since this may result in corrosion.

Battery handling precautions

- In addition to the batteries provided with the camera, the following types of battery can be used. Choose the power source best suited to the situation.

AA alkaline batteries

The number of pictures that you can take may vary considerably depending on the battery manufacturer and shooting conditions.

AA NiMH batteries (rechargeable batteries)

Olympus NiMH batteries are rechargeable and economical. For details, refer to the instruction manual for your charger.



Caution:

Use only batteries approved for use in this product. Otherwise it could result in explosion.

Follow the instructions in this manual (p. 51) when disposing used batteries.

- **The following types of batteries cannot be used:**
 - Lithium battery pack (CR-V3)/AA (R6) manganese (zinc-carbon) batteries/AA (R6) oxyride batteries/AA (R6) lithium batteries**
- Power consumption by the camera varies depending on which functions are used.
- Power is consumed continuously during the conditions described below causing batteries to become exhausted quickly.
 - The zoom is used repeatedly.
 - The shutter button is pressed halfway repeatedly in shooting mode, activating the auto focus.
 - The camera is connected to a computer or printer.
- Battery life varies depending on the type of battery, manufacturer, shooting conditions, etc. Similarly, the camera may turn off without displaying the battery level warning or may display the battery level warning more quickly.

Using an xD-Picture Card

A card (and internal memory) also corresponds to the film that records images in a film camera. Otherwise, the recorded images (data) can be erased, and retouching is also available with the use of a computer. Cards can be removed from the camera and exchanged, but this is not possible with the internal memory. Use of larger capacity cards enables you to take more pictures.

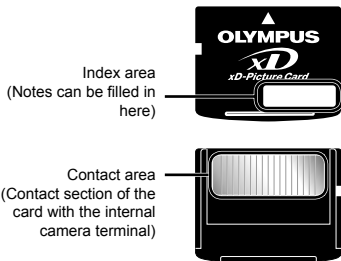

⚠ Do not touch the contact area directly.

Cards compatible with this camera

xD-Picture Card (16MB to 2GB)
(TypeH/M/M+, Standard)

Using a new card

Before using a non-Olympus card or a card that was used for another purpose in a computer or other device, use [MEMORY FORMAT]/[FORMAT] (p. 30) to format the card.

Checking the image saving location

The memory indicator shows whether the internal memory or card is being used during shooting and playback.

Current memory indicator

: Internal memory is being used

None: Card is being used

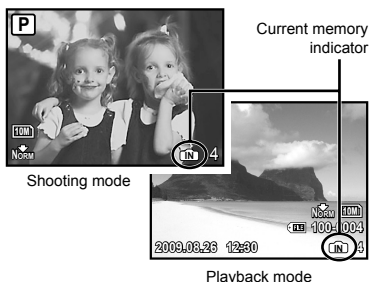

⚠ Even if [MEMORY FORMAT]/[FORMAT], [ERASE], [SEL. IMAGE], or [ALL ERASE] is performed, the data in the card is not completely erased. When disposing of the card, damage the card to prevent the disclosure of personal data.

Readout/recording process of the card

Never open the battery/card compartment cover or unplug the USB cable while the camera is reading or writing data, which is indicated by blinking of the card access lamp. This can not only damage the image data but also render the internal memory or card unusable.

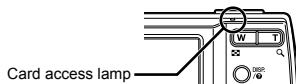

Number of storable pictures (still pictures)/Continuous recording length (movies) in the internal memory and xD-Picture Card

Still pictures

IMAGE SIZE		COMPRES- SION	Number of storable still pictures			
			Internal memory		Using a 1GB xD-Picture Card	
			With sound ^{*1}	Without sound	With sound ^{*1}	Without sound
[10M]	3648×2736	FINE	3	3	178	179
		NORM	6	6	347	353
[5M]	2560×1920	FINE	6	6	353	359
		NORM	12	13	673	695
[3M]	2048×1536	FINE	10	10	565	576
		NORM	21	21	1,102	1,141
[2M]	1600×1200	FINE	17	17	913	940
		NORM	32	35	1,728	1,880
[1M]	1280×960	FINE	26	27	1,390	1,453
		NORM	48	55	2,557	2,906
[VGA]	640×480	FINE	87	110	4,567	5,813
		NORM	152	203	7,993	10,657
[16:9]	1920×1080	FINE	16	16	841	875
		NORM	31	32	1,639	1,728

^{*1} Available in the FE-45/X-40 only.

Movies

IMAGE SIZE		FRAME RATE	Continuous recording length			
			Internal memory		Using a 1 GB xD-Picture Card	
			With sound ^{*1}	Without sound	With sound ^{*1}	Without sound
[VGA]	640×480	[30]	10 sec.	10 sec.	8 min. 59 sec. ^{*2}	9 min. 5 sec. ^{*2}
		[15]	20 sec.	20 sec.	17 min. 48 sec.	18 min. 11 sec.
[QVGA]	320×240	[30]	28 sec.	29 sec.	24 min. 43 sec.	25 min. 28 sec.
		[15]	54 sec.	58 sec.	48 min. 2 sec.	50 min. 55 sec.

! The maximum file size of a single movie is 2 GB, regardless of the capacity of the card.

^{*1} Available in the FE-45/X-40 only.

^{*2} When using a TypeM or Standard xD-Picture Card, the maximum recording length will be 10 seconds.

Increasing the number of pictures that can be taken

Either erase unwanted images, or connect the camera to a computer or other device to save the images, and then erase the images in the internal memory or card.

[ERASE] (p. 16), [SEL. IMAGE] (p. 29), [ALL ERASE] (p. 29), [MEMORY FORMAT]/[FORMAT] (p. 30)

Using the microSD Attachment

- Do not use the attachment with Olympus digital cameras that do not support this microSD Attachment, as well as with other brands of digital cameras, computers, printers, and other devices that support xD-Picture Card. Doing so not only may damage the pictures taken, but may also result in the malfunction of the device.
- If the microSD card cannot be removed, do not use force. Contact authorized distributors/service centers.

Cards compatible with this camera

microSD card/microSDHC card

- For a list of tested microSD cards, please visit our website (<http://www.olympus.com/>).

Sending images



You can send images to a computer or a PictBrige printer by using the USB cable provided with the camera.

To send data to other devices, remove the attachment from the camera and use a commercially available microSD card adapter.

Handling precautions

Do not touch the contact area of the attachment or microSD card. Doing so may cause failure in reading the images. When fingerprints or stains are found on the contact area, wipe the area with a soft dry cloth.

SAFETY PRECAUTIONS

	CAUTION RISK OF ELECTRIC SHOCK DO NOT OPEN	
CAUTION: TO REDUCE THE RISK OF ELECTRICAL SHOCK, DO NOT REMOVE COVER (OR BACK). NO USER-SERVICEABLE PARTS INSIDE. REFER SERVICING TO QUALIFIED OLYMPUS SERVICE PERSONNEL.		



An exclamation mark enclosed in a triangle alerts you to important operating and maintenance instructions in the documentation provided with the product.



DANGER

If the product is used without observing the information given under this symbol, serious injury or death may result.



WARNING

If the product is used without observing the information given under this symbol, injury or death may result.



CAUTION

If the product is used without observing the information given under this symbol, minor personal injury, damage to the equipment, or loss of valuable data may result.

WARNING!

TO AVOID THE RISK OF FIRE OR ELECTRICAL SHOCK, NEVER DISASSEMBLE. EXPOSE THIS PRODUCT TO WATER OR OPERATE IN A HIGH HUMIDITY ENVIRONMENT.

General Precautions

- Read All Instructions** — Before you use the product, read all operating instructions. Save all manuals and documentation for future reference.
- Cleaning** — Always unplug this product from the wall outlet before cleaning. Use only a damp cloth for cleaning. Never use any type of liquid or aerosol cleaner, or any type of organic solvent to clean this product.
- Attachments** — For your safety, and to avoid damaging the product, use only accessories recommended by Olympus.
- Water and Moisture** — For precautions on products with weatherproof designs, read the weatherproofing sections.
- Location** — To avoid damage to the product, mount the product securely on a stable tripod, stand, or bracket.
- Power Source** — Connect this product only to the power source described on the product label.
- Foreign Objects** — To avoid personal injury, never insert a metal object into the product.
- Heat** — Never use or store this product near any heat source such as a radiator, heat register, stove, or any type of equipment or appliance that generates heat, including stereo amplifiers.

Handling the Camera

WARNING

- **Do not use the camera near flammable or explosive gases.**
- **Do not use the flash and LED on people (infants, small children, etc.) at close range.**
 - You must be at least 1 m (3 ft.) away from the faces of your subjects. Firing the flash too close to the subject's eyes could cause a momentary loss of vision.
- **Keep young children and infants away from the camera.**
 - Always use and store the camera out of the reach of young children and infants to prevent the following dangerous situations which could cause serious injury:
 - Becoming entangled in the camera strap, causing strangulation.
 - Accidentally swallowing the battery, cards or other small parts.
 - Accidentally firing the flash into their own eyes or those of another child.
 - Accidentally being injured by the moving parts of the camera.
- **Do not look at the sun or strong lights with the camera.**
- **Do not use or store the camera in dusty or humid places.**
- **Do not cover the flash with a hand while firing.**
- **Do not insert anything into the microSD Attachment other than the microSD card.** Other types of cards cannot be inserted into microSD Attachment.
- **Do not insert anything other than an xD-Picture Card or the microSD Attachment into the camera.**

If you insert a card by mistake, such as a microSD card, do not use force. Contact authorized distributors/service centers.

CAUTION

- **Stop using the camera immediately if you notice any unusual odors, noise, or smoke around it.**
 - Never remove the batteries with bare hands, which may cause a fire or burn your hands.
- **Never hold or operate the camera with wet hands.**
- **Do not leave the camera in places where it may be subject to extremely high temperatures.**
 - Doing so may cause parts to deteriorate and, in some circumstances, cause the camera to catch fire. Do not use the charger if it is covered (such as a blanket). This could cause overheating, resulting in fire.
- **Handle the camera with care to avoid getting a low-temperature burn.**
 - When the camera contains metal parts, overheating can result in a low-temperature burn. Pay attention to the following:
 - When used for a long period, the camera will get hot. If you hold on to the camera in this state, a low-temperature burn may be caused.
 - In places subject to extremely cold temperatures, the temperature of the camera's body may be lower than the environmental temperature. If possible, wear gloves when handling the camera in cold temperatures.
- **Be careful with the strap.**
 - Be careful with the strap when you carry the camera. It could easily catch on stray objects and cause serious damage.

Battery Handling Precautions

Follow these important guidelines to prevent batteries from leaking, overheating, burning, exploding, or causing electrical shocks or burns.

DANGER

- Use only the Olympus brand NiMH batteries and proper fitting charger.
- Never heat or incinerate batteries.
- Take precautions when carrying or storing batteries to prevent them from coming into contact with any metal objects such as jewelry, pins, fasteners, etc.
- Never store batteries where they will be exposed to direct sunlight, or subjected to high temperatures in a hot vehicle, near a heat source, etc.
- To prevent causing battery leaks or damaging their terminals, carefully follow all instructions regarding the use of batteries. Never attempt to disassemble a battery or modify it in any way, solder, etc.
- If battery fluid gets into your eyes, flush your eyes immediately with clear, cold running water and seek medical attention immediately.
- Always store batteries out of the reach of small children. If a child accidentally swallows a battery, seek medical attention immediately.

WARNING

- Keep batteries dry at all times.
- To prevent batteries from leaking, overheating or causing a fire or explosion, use only batteries recommended for use with this product.
- Never mix batteries (old and new batteries, charged and uncharged batteries, batteries of different manufacture or capacity, etc.).
- Never attempt to charge alkaline, lithium or CR-V3 lithium battery packs.
- Insert the battery carefully as described in the operating instructions.
- Do not use batteries if their body is not covered by the insulating sheet or if the sheet is torn, as this may cause fluid leaks, fire or injury.

CAUTION

- Do not remove batteries immediately after using the camera. Batteries may become hot during prolonged use.
- Always unload the battery from the camera before storing the camera for a long period.

The following AA (R6) batteries cannot be used.

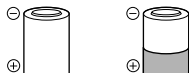

Batteries whose bodies are only partially or not at all covered by an insulating sheet.



Batteries whose \ominus terminals are raised, but not covered by an insulating sheet.

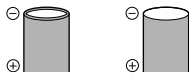

Batteries whose \ominus terminals are flat and not completely covered by an insulating sheet. (Such batteries cannot be used even if the \ominus terminals are partially covered.)

- If NiMH batteries are not charged within the specified time, stop charging them and do not use them.
- Do not use a battery if it is cracked or broken.
- If a battery leaks, becomes discolored, deformed or becomes abnormal in any other way during operation, stop using the camera.
- If a battery leaks fluid onto your clothing or skin, remove the clothing and flush the affected area with clean, running cold water immediately. If the fluid burns your skin, seek medical attention immediately.
- Never subject batteries to strong shocks or continuous vibration.

Caution for Usage Environment

- To protect the high-precision technology contained in this product, never leave the camera in the places listed below, no matter if in use or storage:
 - Places where temperatures and/or humidity are high or go through extreme changes. Direct sunlight, beaches, locked cars, or near other heat sources (stove, radiator, etc.) or humidifiers.
 - In sandy or dusty environments.
 - Near flammable items or explosives.
 - In wet places, such as bathrooms or in the rain. When using products with weatherproof designs, read their manuals as well.
 - In places prone to strong vibrations.
- Never drop the camera or subject it to severe shocks or vibrations.
- When mounted on a tripod, adjust the position of the camera with the tripod head. Do not twist the camera.
- Do not touch electric contacts on cameras.
- Do not leave the camera pointed directly at the sun. This may cause lens or shutter curtain damage, color failure, ghosting on the CCD, or may possibly cause fires.
- Do not push or pull severely on the lens.
- Before storing the camera for a long period, remove the batteries. Select a cool, dry location for storage to prevent condensation or mold from forming inside the camera. After storage, test the camera by turning it on and pressing the shutter button to make sure that it is operating normally.
- Always observe the operating environment restrictions described in the camera's manual.

Battery Handling Precautions

- Olympus NiMH batteries (included in some areas) are intended for use only with Olympus digital cameras. Never use these batteries with any other device.
- Always charge NiMH batteries (included in some areas) before using them for the first time, or if they have not been used for a long period.
- Always charge sets of batteries (included in some areas) (2 or 4) together.
- Do not use alkaline batteries unless it is absolutely necessary. In some cases, alkaline batteries may have a shorter service life than NiMH. Alkaline battery performance is limited, especially at low temperatures. The use of NiMH batteries is recommended.
- AA manganese (Zinc-Carbon) batteries cannot be used with this camera.
- When operating the camera with battery power at low temperatures, try to keep the camera and spare batteries as warm as possible. Batteries which run down at low temperatures may be restored after they are warmed at room temperature.
- Recommended temperature ranges for NiMH batteries:

Operation	0°C to 40°C (32°F to 104°F)
Charge	0°C to 40°C (32°F to 104°F)
Storage.....	-20°C to 30°C (-4°F to 86°F)
- Using, charging or storing the batteries outside these ranges could shorten battery life or affect battery performance. Always unload the batteries from the camera before storing the camera for a long period.
- Before using NiMH or NiCd batteries, always read the provided instructions.
- The number of pictures you can take may vary depending on the shooting conditions or batteries.
- Before going on a long trip, and especially before traveling abroad, purchase an ample supply of extra batteries. The recommended batteries may be difficult to obtain while traveling.
- Please recycle batteries to help save our planet's resources. When you throw away dead batteries, be sure to cover their terminals and always observe local laws and regulations.

LCD Monitor

- Do not push the monitor forcibly; otherwise the image may become vague, resulting in a playback mode failure or damage to the monitor.
- A strip of light may appear on the top/bottom of the monitor, but this is not a malfunction.
- When a subject is viewed diagonally in the camera, the edges may appear zigzagged on the monitor. This is not a malfunction; it will be less noticeable in playback mode.
- In places subject to low temperatures, the LCD monitor may take a long time to turn on or its color may change temporarily. When using the camera in extremely cold places, it is a good idea to occasionally place it in a warm place. An LCD monitor exhibiting poor performance due to low temperatures will recover in normal temperatures.
- The LCD used for the monitor is made with high-precision technology. However, black spots or bright spots of light may appear constantly on the LCD Monitor. Due to its characteristics or the angle at which you are viewing the monitor, the spot may not be uniform in color and brightness. This is not a malfunction.

Legal and Other Notices

- Olympus makes no representations or warranties regarding any damages, or benefit expected by using this unit lawfully, or any request from a third person, which are caused by the inappropriate use of this product.
- Olympus makes no representations or warranties regarding any damages or any benefit expected by using this unit lawfully which are caused by erasing picture data.

Disclaimer of Warranty

- Olympus makes no representations or warranties, either expressed or implied, by or concerning any content of these written materials or software, and in no event shall be liable for any implied warranty of merchantability or fitness for any particular purpose or for any consequential, incidental or indirect damages (including but not limited to damages for loss of business profits, business interruption and loss of business information) arising from the use or inability to use these written materials or software or equipment. Some countries do not allow the exclusion or limitation of liability for consequential or incidental damages, so the above limitations may not apply to you.
- Olympus reserves all rights to this manual.

Warning

Unauthorized photographing or use of copyrighted material may violate applicable copyright laws. Olympus assumes no responsibility for unauthorized photographing, use or other acts that infringe upon the rights of copyright owners.

Copyright Notice

All rights reserved. No part of these written materials or this software may be reproduced or used in any form or by any means, electronic or mechanical, including photocopying and recording or the use of any type of information storage and retrieval system, without the prior written permission of Olympus. No liability is assumed with respect to the use of the information contained in these written materials or software, or for damages resulting from the use of the information contained therein. Olympus reserves the right to alter the features and contents of this publication or software without obligation or advance notice.

For customers in Europe



"CE" mark indicates that this product complies with the European requirements for safety, health, environment and customer protection. "CE" mark cameras are intended for sales in Europe.



This symbol [crossed-out wheeled bin WEEE Annex IV] indicates separate collection of waste electrical and electronic equipment in the EU countries.

Please do not throw the equipment into the domestic refuse.

Please use the return and collection systems available in your country for the disposal of this product.



This symbol [crossed-out wheeled bin Directive 2006/66/EC Annex II] indicates separate collection of waste batteries in the EU countries. Please do not throw the batteries into the domestic refuse. Please use the return and collection systems available in your country for the disposal of the waste batteries.

Provisions of warranty

- 1 If this product proves to be defective, although it has been used properly (in accordance with the written "Safety Precautions" and Operating instructions supplied with it), during a period of two years from the date of purchase from an authorized Olympus distributor within the business area of Olympus Imaging Europa GmbH as stipulated on the website: <http://www.olympus.com> this product will be repaired, or at Olympus's option replaced, free of charge. To claim under this warranty the customer must take the product and this Warranty Certificate before the end of the two year warranty period to the dealer where the product was purchased or any other Olympus service station within the business area of Olympus Imaging Europa GmbH as stipulated on the website: <http://www.olympus.com>. During the one year period of the World Wide Warranty the customer may turn the product in at any Olympus service station. Please notice that not in all countries such Olympus service station exists.
 - 2 The customer shall transport the product to the dealer or Olympus authorized service station at his own risk and shall be responsible for any costs incurred in transporting the product.
 - 3 This warranty does not cover the following and the customer will be required to pay repair charge, even for defects occurring within the warranty period referred to above.
 - a. Any defect that occurs due to mishandling (such as an operation performed that is not mentioned in the "Safety Precautions" or other sections of the instructions, etc.)
 - b. Any defect that occurs due to repair, modification, cleaning, etc. performed by anyone other than Olympus or an Olympus authorized service station.
 - c. Any defect or damage that occurs due to transport, a fall, shock, etc. after purchase of the product.
 - d. Any defect or damage that occurs due to fire, earthquake, flood damage, thunderbolt, other natural disasters, environmental pollution and irregular voltage sources.
 - e. Any defect that occurs due to careless or improper storage (such as keeping the product under conditions of high temperature and humidity, near insect repellents such as naphthalene or harmful drugs, etc.), improper maintenance, etc.
 - f. Any defect that occurs due to exhausted batteries, etc.
 - g. Any defect that occurs due to sand, mud, etc. entering the inside of the product casing.
 - h. When this Warranty Certificate is not returned with the product.
 - i. When any alterations whatsoever are made to the Warranty Certificate regarding the year, month and date of purchase, the customer's name, the dealer's name, and the serial number.
 - j. When proof of purchase is not presented with this Warranty Certificate.
- 4 This Warranty applies to the product only; the Warranty does not apply to any other accessory equipment, such as the case, strap, lens cap and batteries.
- 5 Olympus's sole liability under this warranty shall be limited to repairing or replacing the product. Any liability for indirect or consequential loss or damage of any kind incurred or suffered by the customer due to a defect of the product, and in particular any loss or damage caused to any lenses, films, other equipment or accessories used with the product or for any loss resulting from a delay in repair or loss of data, is excluded. Compelling regulations by law remain unaffected by this.

Notes regarding warranty maintenance

- 1 This warranty will only be valid if the Warranty Certificate is duly completed by Olympus or an authorized dealer or other documents contain sufficient proof. Therefore, please make sure that your name, the name of the dealer, the serial number and the year, month and date of purchase are all completed or the original invoice or the sales receipt (indicating the dealer's name, the date of purchase and product type) is attached to this Warranty Certificate. Olympus reserves the right to refuse free-of-charge service if neither Warranty Certificate is completed nor the above document is attached or if the information contained in it is incomplete or illegible.
 - 2 Since this Warranty Certificate will not be re-issued, keep it in a safe place.
- * Please refer to the list on the website: <http://www.olympus.com> for the authorized international Olympus service network.

Trademarks

- IBM is a registered trademark of International Business Machines Corporation.
- Microsoft and Windows are registered trademarks of Microsoft Corporation.
- Macintosh is a trademark of Apple Inc.
- xD-Picture Card™ is a trademark.
- microSD is a trademark of the SD Association.
- All other company and product names are registered trademarks and/or trademarks of their respective owners.
- The standards for camera file systems referred to in this manual are the "Design rule for Camera File system/DCF" standards stipulated by the Japan Electronics and Information Technology Industries Association (JEITA).

SPECIFICATIONS

Camera

Product type	: Digital camera (for shooting and displaying)
Recording system	
Still pictures	: Digital recording, JPEG (in accordance with Design rule for Camera File system (DCF))
Applicable standards	: Exif 2.2, Digital Print Order Format (DPOF), PRINT Image Matching III, PictBridge
Sound with still pictures^{*1}	: Wave format
Movie	: AVI Motion JPEG
Memory	: Internal memory xD-Picture Card (16 MB to 2 GB) (TypeH/M/M+, Standard) microSD card/microSDHC card (when the supplied microSD Attachment is used.)
No. of effective pixels	: 10,000,000 pixels
Image pickup device	: 1/2.33" CCD (primary color filter), 10,700,000 pixels (gross)
Lens	: Olympus lens 6.3 to 18.9 mm, f3.1 to 5.9 (equivalent to 36 to 108 mm on a 35 mm camera)
Photometric system	: Digital ESP metering system
Shutter speed	: 4 to 1/2000 sec.
Shooting range	: 0.6 m (2.0 ft.) to ∞ (W), 1.0 m (3.3 ft.) to ∞ (T) (normal) 0.1 m (0.3 ft.) to ∞ (W), 0.6 m (2.0 ft.) to ∞ (T) (macro mode) 0.05 m (0.16 ft.) to ∞ (super macro mode)
Monitor	: 2.5" TFT color LCD display, 230,000 dots
Connector	: FE-45/X-40: Multi-connector (USB connector, A/V OUT jack) FE-35/X-30: Multi-connector (USB connector, VIDEO OUT jack)
Automatic calendar system	: 2000 up to 2099
Operating environment	
Temperature	: 0 °C to 40 °C (32 °F to 104 °F) (operation) / -20 °C to 60 °C (-4 °F to 140 °F) (storage)
Humidity	: 30 % to 90 % (operation)/10 % to 90 % (storage)
Power supply	: AA alkaline / NiMH battery (two)
Dimensions	: 93.8 mm (W) × 61.5 mm (H) × 26.7 mm (D) (3.7 × 2.4 × 1.1 in.) (excluding protrusions)
Weight	: FE-45/X-40: 112 g (3.9 oz) (excluding batteries and card) FE-35/X-30: 110 g (3.9 oz) (excluding batteries and card)

^{*1} Available in the FE-45/X-40 only.

microSD Attachment

Product type	: Attachment for microSD card
Operating Environment	
Temperature	: -10 °C to 40 °C (14 °F to 104 °F) (operation) / -20 °C to 65 °C (-4 °F to 149 °F) (storage)
Humidity	: 95 % and below (operation) / 85 % and below (storage)
Dimensions	: 25.0 mm (W) × 20.3 mm (H) × 1.7 mm (D) (1.0 × 0.8 × 0.07 in.) (Handle:2.2 mm (0.09 in.))
Weight	: Approx. 0.9 g (0.03 oz)

Design and specifications subject to change without notice.

Index

A

- Arrow pad 12
- AV cable..... 32



B

- Backlight boost 21
- BACKUP..... 30
- Battery 10, 45
- Beep 31
- Brightness
 - Backlight boost 21
 - Exposure compensation 20
 - Monitor brightness  31

C

- Card
 - microSD Card 11, 48
 - microSDHC card..... 11, 48
 - xD-Picture Card 10, 46
- Compression..... 24
- Connecting
 - PC..... 39
 - Printer 34
 - TV 32
- CUSTOM PRINT 35

D

- Date and time  12, 31
- DIS MODE  18
- Display language  13, 30

E

- EASY PRINT 34
- Edit (still images)
 - Cropping  28
 - Resize  28

ERASE

- ALL ERASE 29
- SEL. IMAGE 29
- Single image erase 16
- Error message 42

F

- FACE DETECT 26
- Flash
 - FILL IN 19
 - FLASH AUTO 19
 - FLASH OFF 19
 - REDEYE 19
- FORMAT 30
- Frame rate 24
- FUNC menu 22

I

- iAUTO mode 17
- IMAGE QUALITY  24
- Image size 24
- Information display..... 22, 23
- ISO sensitivity 25

M

- Macro  20
- Maintenance
 - Camera care 45
 - PIXEL MAPPING 30
- MEMORY FORMAT 30
- MENU COLOR 31
- microSD Attachment..... 11, 48

N

- Natural color 25



O

OLYMPUS Master 2	39
Operation guide	12







P

PANORAMA	26
PictBridge	34
Playback image	
Closeup view	23
Index view	23
Movies	15
On TV	32
Viewing images	15
P mode	14
POWER SAVE	33
Print	34
Print Reservations (DPOF)	37
Protecting images On	28

R

RESET 	27
Rotating images 	28

S

SCN mode	17
Self-timer	21
Shooting	14
Shooting movies 	18
SILENT MODE 	33
SLIDESHOW 	28
Sound recording 	25, 29
Strap	10
SUPER MACRO 	20
SWITCH SHOOTING MODES 	27

T

Turning on the camera	12
	31

U

USB cable	34, 39
Using the Menu	3

V

VIDEO OUT	32
-----------------	----

W

WB	25
----------	----

Z

Zoom	19
------------	----



<http://www.olympus.com/>

OLYMPUS IMAGING CORP.

Shinjuku Monolith, 3-1 Nishi-Shinjuku 2-chome, Shinjuku-ku, Tokyo, Japan

OLYMPUS IMAGING AMERICA INC.

3500 Corporate Parkway, P.O. Box 610, Center Valley, PA 18034-0610, U.S.A. Tel. 484-896-5000

Technical Support (USA)

24/7 online automated help: <http://www.olympusamerica.com/support>

Phone customer support: Tel. 1-888-553-4448 (Toll-free)

Our phone customer support is available from 8am to 10pm

(Monday to Friday) and 9am to 5pm (Sunday) ET

<http://olympusamerica.com/contactus>

Olympus software updates can be obtained at: <http://www.olympusamerica.com/digital>

OLYMPUS IMAGING EUROPA GMBH

Premises: Wendenstrasse 14-18, 20097 Hamburg, Germany

Tel: +49 40-23 77 3-0 / Fax: +49 40-23 07 61

Goods delivery: Bredowstrasse 20, 22113 Hamburg, Germany

Letters: Postfach 10 49 08, 20034 Hamburg, Germany

European Technical Customer Support:

Please visit our homepage <http://www.olympus-europa.com>

or call our TOLL FREE NUMBER* : **00800 - 67 10 83 00**

for Austria, Belgium, Denmark, Finland, France, Germany, Italy, Luxemburg, Netherlands, Norway, Portugal, Spain, Sweden, Switzerland, United Kingdom

* Please note some (mobile) phone services providers do not permit access or request an additional prefix to +800 numbers.

For all European Countries not listed and in case that you can't get connected

to the above mentioned number, please make use of the following

CHARGED NUMBERS: **+49 180 5 - 67 10 83** or **+49 40 - 237 73 4899**

Our Technical Customer Support is available from 9 am to 6 pm MET (Monday to Friday)