

DIGITAL CAMERA

**OLYMPUS**<sup>®</sup>

# SP-510UZ

## Advanced Manual

### Quick Start Guide

This manual will help you get started using your camera right away.

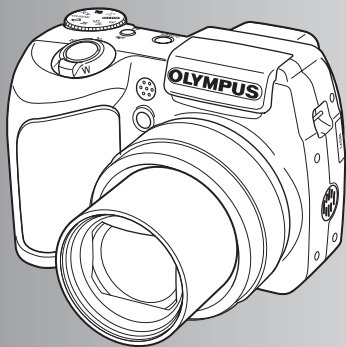

### Button operations

### Menu operations

### Printing pictures

### Using OLYMPUS Master

### Getting to know your camera better

### Miscellaneous

- Thank you for purchasing an Olympus digital camera. Before you start to use your new camera, please read these instructions carefully to enjoy optimum performance and a longer service life. Keep this manual in a safe place for future reference.
- We recommend that you take test shots to get accustomed to your camera before taking important photographs.
- In the interest of continually improving products, Olympus reserves the right to update or modify information contained in this manual.
- The screen and camera illustrations shown in this manual were produced during the development stages and may differ from the actual product.

**Button operations** P. 10

---

Test out the functions of the camera buttons by following the illustrations and actually trying them out on the camera.

**Menu operations** P. 18

---

Learn everything about the menus, from basic operations to the functions of each menu and their various settings.

**Printing pictures** P. 46

---

Learn how to print pictures you have taken.

**Using OLYMPUS Master** P. 52

---

Learn how to transfer pictures to a computer and save them.

**Getting to know your camera better** P. 62

---

Find out more about your camera and learn what to do when you have a question regarding operations.

**Miscellaneous** P. 76

---

Read about convenient functions and safety precautions on how to use your camera more effectively.

## Gather these items (box contents)



Digital Camera



Lens Cap/Lens Cap String

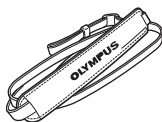

Strap



AA Batteries (four)

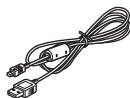

USB Cable

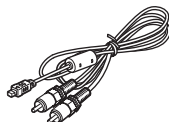

AV Cable



OLYMPUS Master Software CD-ROM

Items not shown: Advanced Manual (this manual), Basic Manual and warranty card.  
Contents may vary depending on purchase location.

### Attach the strap and the lens cap

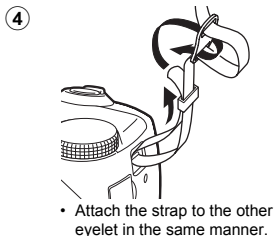
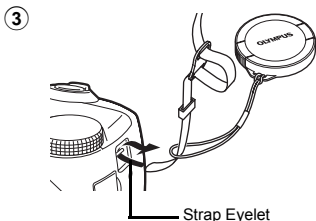
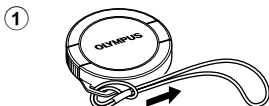

- Pull the strap tight so that it does not come loose.

## Prepare the battery

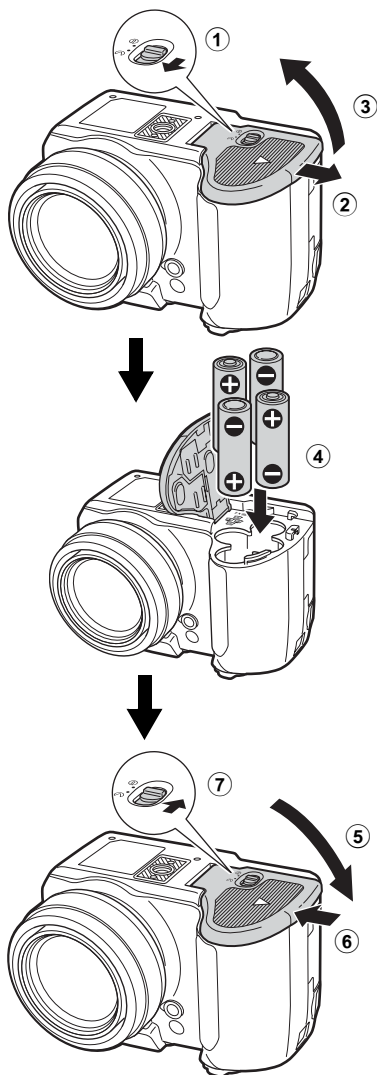

- For details on inserting an optional xD-Picture Card (hereinafter called the card), please refer to “Inserting and removing the card” (P. 78).

# Turn the camera on

This explains how to turn on the camera in shooting mode.

## a. Set the mode dial to **AUTO**.

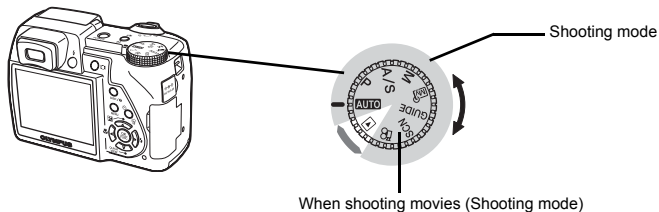

### Still picture shooting modes

<b>AUTO</b>	Allows you to take pictures with full automatic settings.
<b>P</b>	The camera automatically sets the optimum aperture value and shutter speed.
<b>A/S</b>	Allows you to set the aperture manually. / Allows you to set the shutter speed manually.
<b>M</b>	Allows you to set both the aperture and shutter speed manually.
<b>Mv</b>	Allows you to set each shooting function manually and use as your original shooting mode.
<b>GUIDE</b>	Allows you to set the target items by following the shooting guide displayed on the screen.
<b>SCN</b>	Allows you to shoot pictures by selecting a scene according to the shooting condition.

## b. Press the **POWER** button.

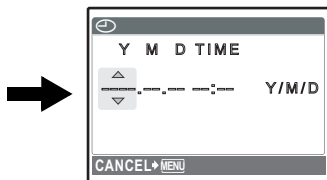
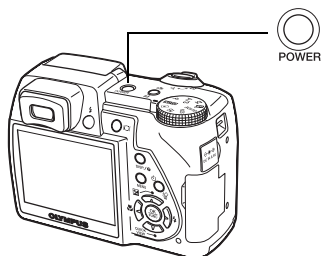

• This is displayed when the date and time are not set.

• To turn on the camera, press the **POWER** button after removing the lens cap.

● To turn off the camera, press the **POWER** button once again.

# Set date and time

## About the date and time setting screen

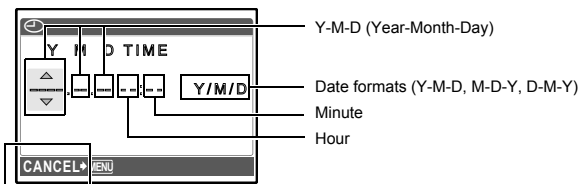

Exits a setting.

- a. Press the button and the QUICK VIEW button to select [Y].

• The first two digits of the year are fixed.

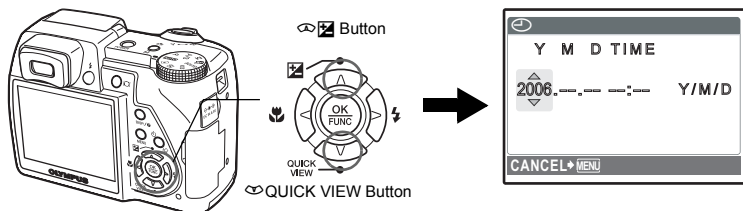

- b. Press the button.

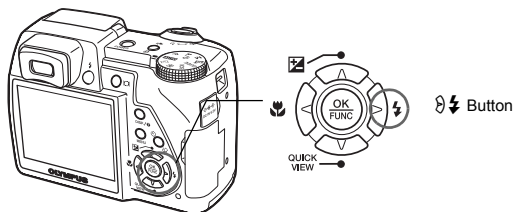

- c. Press the button and the QUICK VIEW button as in a. to select [M].

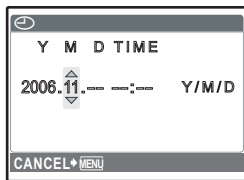

- d. Press the button.

- e. Press the   button and the  QUICK VIEW button to select [D].

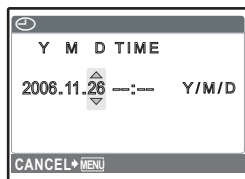

- f. Press the  button.

- g. Press the   button and the  QUICK VIEW button to select “hour”, “minute”.

- The time is displayed in the 24-hour format.

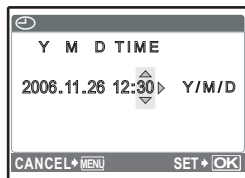

- h. Press the  button.

- i. Press the   button and the  QUICK VIEW button to select [Y/M/D].

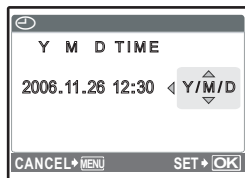

- j. After all items have been set, press the  button.

- For precise time setting, press the  button as the time signal strikes 00 seconds.

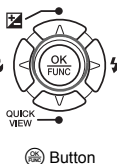
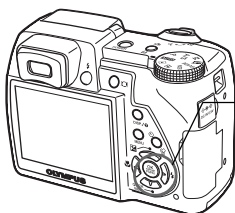

# Shoot

## a. Hold the camera

Horizontal grip

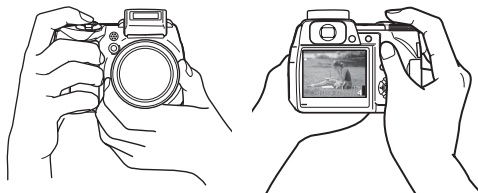

Vertical grip

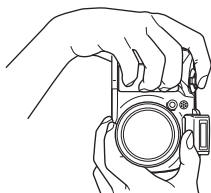

## b. Focus

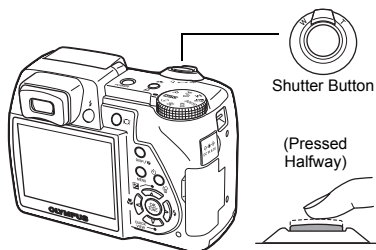

Place this mark over your subject.

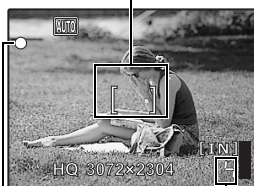

The number of storable still pictures is displayed.

The green lamp indicates the focus and exposure are locked.

## c. Shoot

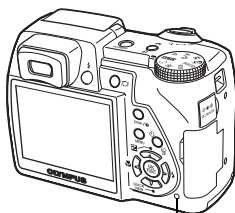
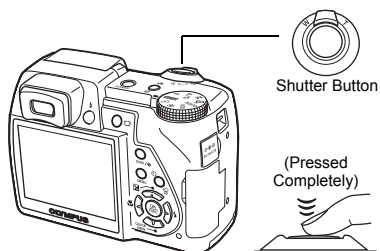

The card access lamp blinks.



# View pictures

a. Set the mode dial to .

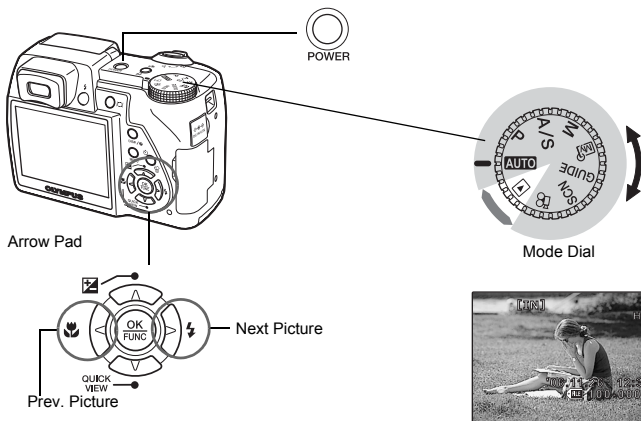

## Erase pictures

a. As described in a. above, display the picture you want to erase.

b. Press the   button.

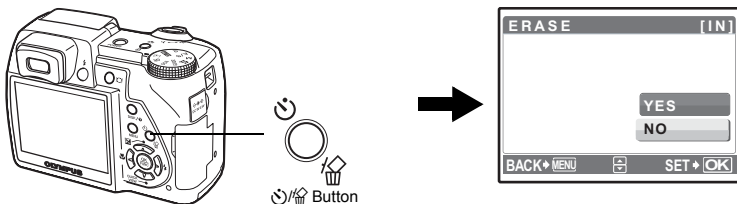

c. Press the   button to select **[YES]**, and press the  button to erase the image.

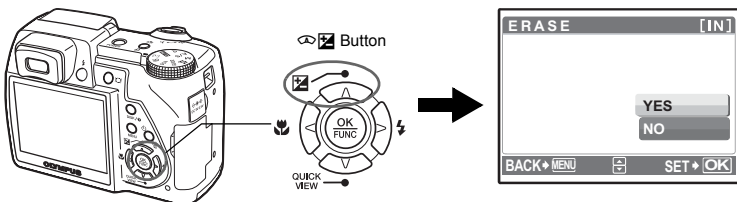

# Button operations

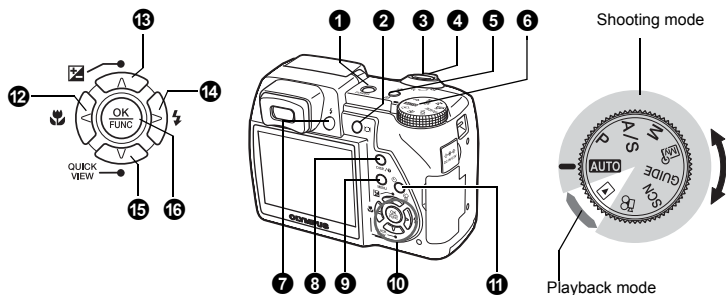

## 1 POWER button

Turning the camera on and off

Power on:

- Shooting mode
- Monitor turns on
  - Lens extends
  - Before turning the camera on in shooting mode, remove the lens cap, and then press **POWER**.

- Playback mode
- Monitor turns on

## 2 button

Monitor/Viewfinder

Toggles between the monitor and viewfinder.

## 3 Shutter button

Shooting pictures

### Shooting still pictures

Set the mode dial to **AUTO**, **P**, **A/S**, **M**, **M<sub>F</sub>**, **GUIDE** or **SCN**, and lightly press the shutter button (halfway). The green lamp lights when the focus and exposure are locked (focus lock). Now press the shutter button all the way (completely) to shoot a picture.



### Locking the focus and then composing the shot (focus lock)

Compose your picture with the focus locked, and then completely press the shutter button to shoot a picture. When the green lamp blinks, the focus is not adjusted properly. Try locking the focus again.

## Recording movies

Set the mode dial to , and press the shutter button halfway to lock the focus, and then press the shutter button completely to start recording. Press the shutter button again to stop recording.

## 4 Zoom lever

### Zooming while shooting/close-up playback

#### Shooting mode: Zooming in on your subject

Optical zoom: 10×

Zoom out:

Push the lever toward W.

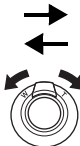

Zoom in:

Pull the lever toward T.

#### Playback mode: Switching the picture display

##### Single-frame playback

- Use the arrow pad to browse pictures.

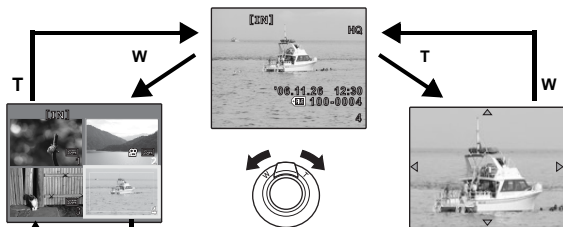

##### Close-up playback

- Pull the lever toward T to incrementally enlarge the picture up to 10 times the original size. Push the lever toward W to reduce the size.
- Press the arrow pad during close-up playback to scroll the picture in the indicated direction.
- Press  to return to the single-frame playback.

##### Index display

- Use the arrow pad to select a picture for playback, and press  to play back the single-frame of the picture selected.

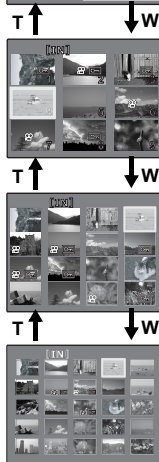



##### Calendar display

- Use the arrow pad to select the date, and press  or pull the lever toward T on the zoom button to display the pictures on the date selected.



## 5 button Shooting still pictures and movies with digital image stabilization/Printing pictures

Press  in shooting mode to select [ON] or [OFF] for the digital image stabilization. Press  to set.

### Still picture shooting mode: Shooting with digital image stabilization

This function reduces the blur incurred by camera movement or subject movement when taking pictures.

 "DIS MODE Shooting still pictures using digital image stabilization" (P. 25)

### Movie shooting mode: Shooting with digital image stabilization

This function reduces the blur incurred by camera movement when taking movies.







 "DIS MOVIE MODE Reducing the blur incurred by camera movement when taking movies" (P. 29)

Frequently used functions can be assigned to  button as a custom button when the mode dial is set to **P**, **A/S**, **M**,  or **SCN**. When the mode dial is set to **AUTO**, DIS MODE is activated. When the mode dial is set to , DIS MOVIE MODE is activated.







 "CUSTOM BUTTON Assigning functions to the custom buttons" (P. 45)

"Functions that can be assigned to My Mode and custom button" (P. 72)

### Locking the focus position (AF lock)

- Register the AF lock function to  so that the focus is locked by pressing  and  (AF lock mark) is displayed on the monitor. Press  again to cancel the AF lock. Each time you press the button, focus is locked and canceled alternately.
- To save the locked focus position after taking a picture (AF memory), hold down  for more than 1 second so that  (AF memory mark) is displayed on the monitor. Press  again to reset the AF memory.
- If the zoom is operated after engaging the AF lock, the picture may be out of focus. Engage the AF lock after operating the zoom.

### Locking the exposure (AE lock)

- Register the AE lock function to  so that the meter reading is saved by pressing  and the exposure is locked.  (AE lock mark) is displayed on the monitor. Press  again to cancel the AE lock. Each time you press the button, exposure is locked and canceled alternately.
- AE lock is automatically canceled after each shooting.
- To save the locked meter reading after taking a picture, hold down  for more than 1 second so that  (AE memory mark) is displayed on the monitor. Press  again to reset the AE memory.

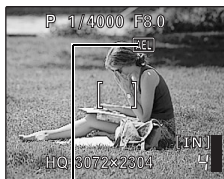
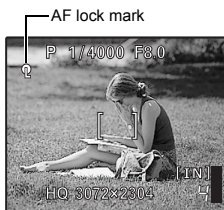

(AEL) is displayed while in AE lock.

### Playback mode: Printing pictures

When the printer is connected to the camera, display a picture to be printed out in playback mode, and press .

 "EASY PRINT" (P. 46)

## 6 Mode dial Switching between shooting and playback modes

Set the mode dial to the desired shooting or playback mode.

• Some functions cannot be set depending on the position of the mode dial.

 "Functions available in shooting modes and scenes" (P. 72)

**AUTO** Shooting pictures with full automatic settings

The camera determines the optimum settings and shoots the picture.

**P** Set the optimum aperture value and shutter speed

The camera automatically sets the optimum aperture value and shutter speed for the brightness of the subject.

**A/S** Changing the aperture value / Changing the shutter speed

Adjustment range:  
Wide angle: F2.8 to F8.0  
Telephoto: F3.7 to F8.0

**Changing the aperture value for shooting pictures**

Press  $\odot$   $\odot$  after pressing  $\odot$   $\square$ . The camera automatically sets the shutter speed.

**Aperture value**

$\odot$  : Increases the aperture value.

$\odot$  : Decreases the aperture value.

When the correct exposure cannot be obtained, the aperture value is displayed in red.

$\odot$  : Sets the settings.



Shutter speed range:  
1/2 to 1/1000  
(When [NOISE REDUCT.] is  
set to [ON]: up to 4 sec.)

**Changing the shutter speed for shooting pictures**

Press  $\odot$   $\odot$  after pressing  $\odot$   $\square$ . The camera automatically sets the aperture value.

**Shutter speed**

$\odot$  : Sets the shutter speed faster.

$\odot$  : Sets the shutter speed slower.

When the correct exposure cannot be obtained, the shutter speed is displayed in red.

$\odot$  : Sets the settings.

- Use the function menu to switch **A** and **S**.

$\odot$  "Functions that can be set in the function menu" (P. 17)

**M** Changing the aperture value and shutter speed for shooting pictures

Press  $\odot$   $\odot$   $\odot$  after pressing  $\odot$   $\square$ .



Setting range  
Aperture value: F2.8 to F8.0  
Shutter speed: 15" to 1/1000  
(The shutter speed varies  
depending on the aperture  
value.)

**Exposure differential**

When this range has been exceeded  $\pm 3.0$ EV, the exposure differential is displayed in red.

**Aperture value**

$\odot$  : Decreases the aperture value.

$\odot$  : Increases the aperture value.

**Shutter speed**

$\odot$  : Sets the shutter speed faster.

$\odot$  : Sets the shutter speed slower.

$\odot$  : Completes the setting.

## To take long exposure (bulb) shots

Press to set shutter speed to BULB. The shutter remains open as long as the shutter button is pressed. (The maximum time that it can remain open is 8 minutes.)

### **Setting your own original mode for shooting pictures**

This mode allows you to set each shooting function manually and use as your original shooting mode.

"MY MODE SETUP Setting and saving shooting-related functions" (P. 44)

Use the function menu to switch my mode.

"Functions that can be set in the function menu" (P. 17)

### **GUIDE Follow the shooting guide for setting**

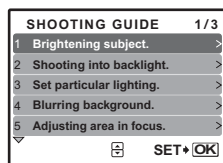

Follow the shooting guide displayed on the screen to set the target items.

- Press **MENU** to display the shooting guide again.
- To change the setting without using the shooting guide, set the shooting mode to another one.
- The content set using the shooting guide will change to the default setting by pressing **MENU** or changing the mode using the mode dial.

### **SCN Shoot pictures by selecting a scene according to the situation**

You can shoot pictures by selecting a scene according to the situation.

#### **Select the scene/change the scene to another one**

- Press **MENU** to select [SCN] from the top menu, and change it to another scene.
- By switching to the other scene, most settings will be changed to the default settings of each scene.

### **Recording movies**

When is set to [ON], audio is recorded with the movie.

- When is set to [ON], optical zoom cannot be used during the shooting.

"🎤 (movies) Recording sound with movies" (P. 29)

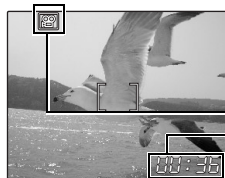

- To zoom in when is set to [ON], set [DIGITAL ZOOM] to [ON].

"DIGITAL ZOOM Zooming in on your subject" (P. 24)

This lights red during movie recording.

The remaining recording time is displayed.  
When the remaining recording time reaches 0, recording stops.

### **Viewing still pictures/Selecting playback mode**

The last picture taken is displayed.

- Press the arrow pad to view other pictures.
- Use the zoom button to switch among close-up playback, index display and calendar display.

Movie playback "MOVIE PLAY Playing back movies" (P. 31)

### **7** **button**

### **Flash pop-up**

Opens the flash. Press this button to take a picture with flash.

"🔦 button Flash shooting" (P. 17)

## 8 DISP./ button

Changing the information on display/Display the menu guide/Checking the time

### Changing the information displays

Press **DISP./** to change the display in the following order.

#### Shooting mode

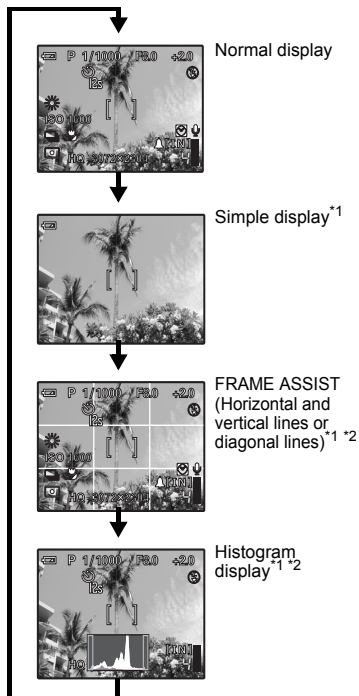

#### Playback mode

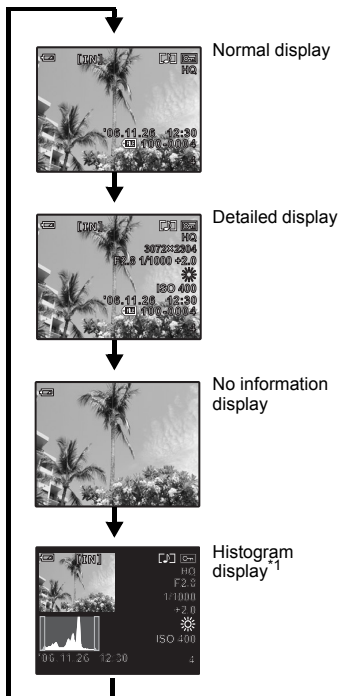

\*<sup>1</sup> Not displayed in case of .



\*<sup>2</sup> Not displayed if it is set to [OFF] in the menu.

 "Displaying the histogram" (P. 44)

 "FRAME ASSIST Displaying the frame assist/Determining the type of frame assist" (P. 44)

### Displaying the menu guide



With menu items selected, hold down **DISP./** to display the menu guide. Release **DISP./** to close the menu guide.

## Checking the time

While the camera is off, press **DISP./** to display the set alarm time (when [ALARM CLOCK] is set) and the current time for 3 seconds.

## 9 MENU button (MENU)

Displays the top menu.

## 10 Arrow pad ( )

Select scenes, playback picture, and the items on the menus.

## 11 Self-timer/Erasing pictures button

### Self-timer shooting/Erasing pictures

#### Shooting mode: Self-timer shooting

Press **Self-timer/Erasing pictures** in shooting mode to select on and off of the self-timer. Press **DISP./** for setting.

<b>OFF</b>	Cancel the self-timer.
<b>12 SEC</b>	After the setting, press the shutter button completely. The self-timer lamp lights for approximately 10 seconds, then starts blinking. After blinking for approximately 2 seconds, the picture is taken.
<b>2 SEC</b>	After the setting, press the shutter button completely. The self-timer lamp flashes for 2 seconds, the picture is taken.

- To cancel the self-timer, press **Self-timer/Erasing pictures**.
- Self-timer shooting is automatically canceled after one shot.

#### Playback mode: Erasing pictures

Select the picture you want to erase, and press **Self-timer/Erasing pictures**.

- Once erased, pictures cannot be restored. Check each picture before erasing to avoid accidentally erasing pictures you want to keep.

Refer to "Protecting pictures" (P. 35)

## 12 Macro button

### Shooting pictures close to the subject

Press **Macro** in shooting mode to select the macro mode. Press **DISP./** for setting.

<b>OFF</b>	Cancels the macro mode.
<b>Macro mode</b>	Allows you to shoot from as close as 7cm/2.88 in. (when the zoom is set for the zoom-out angle) to your subject.
<b>Super macro mode</b>	Allows you to shoot from as close as 3cm/1.19 in. to your subject.

- During super macro mode, the zoom, flash and AF predict are not available.

## 13 Exposure button

### Changing picture brightness



Press **Exposure** in shooting mode to adjust the exposure.

- Adjustable from -2.0EV to +2.0 EV



**Brighten**  
**Darken**







**DISP./**: Activate the setting contents.





## 14 button

### Flash shooting

Press  in shooting mode to select the flash mode. Press  for setting.

AUTO (Auto-flash)	The flash fires automatically in low light or backlight conditions.
 Red-eye reduction flash	Emits pre-flashes for red-eye reduction.
 Fill-in flash	The flash fires regardless of the available light.
  Red-eye fill-in flash	The flash always fires after pre-flashes for red-eye reduction are emitted.
 SLOW	The flash fires with slow speed.
 Flash off	The flash does not fire even in low light conditions.

- To take a picture with the flash, press . The settings cannot be made if the flash is not popped up.  
  button Flash pop-up" (P. 14)
- Some items cannot be set depending on the position of the mode dial.

## 15 QUICK VIEW button

### Viewing pictures

The last picture taken is displayed on the monitor. Press  **QUICK VIEW** in shooting mode. To return to shooting mode, press the shutter button halfway.

## 16 button (OK/FUNC)

Displays the function menu and sets the functions often used in shooting mode. This button is also used to confirm the setting.

### Functions that can be set in the function menu





#### A/S Switching aperture priority / shutter speed priority



Select the shooting mode when the mode dial is set to **A/S**.

<b>A</b> (Aperture priority)	Allows you to set the aperture yourself and the camera automatically varies the shutter speed.
<b>S</b> (Shutter speed priority)	Allows you to set the shutter speed yourself and the camera automatically varies the aperture.

- Displayed when the mode dial is set to **A/S**.

#### 1 / 2 / 3 / 4 Switching the registered original shooting mode

 1 /  2 /  3 /  4

- Displayed when the mode dial is set to .
- Settings are registered on  1 as a factory default.

Function menu



-  "WB Adjusting the color of a picture" (P. 22)
- "ISO Changing the ISO sensitivity" (P. 23)
- "DRIVE Continuous shooting" (P. 23)
- "METERING Changing the area for measuring the brightness of a subject" (P. 24)

: Select a setting, and press .

: Select the setting items.

# Menu operations

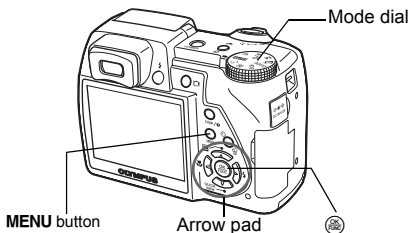

## About the menus

Pressing **MENU** displays the top menu on the monitor.

- The items displayed on the top menu differ according to the mode.

Top menu (in still picture shooting mode)

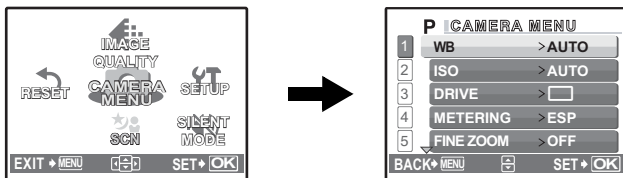

- When [CAMERA MENU], [PLAYBACK MENU], [EDIT], [ERASE], or [SETUP] is selected, the menu corresponding to the respective functions is displayed.
- When your camera is set according to the shooting guide with the mode dial set at **GUIDE**, press **MENU** to display the shooting guide screen.

## Operation guide

During menu operations, the button to be used and its function are displayed at the bottom of the monitor. Follow the guide for operations.

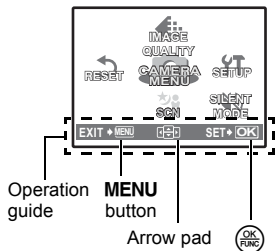

- BACK → MENU: Returns to the previous menu.
- EXIT → MENU: Exits the menu.
- [ ] : Press [ ] to select a setting.
- SET → [ ]: Sets the selected item.

## Using the menus

This explains how to use the menu with [DIGITAL ZOOM] as an example.



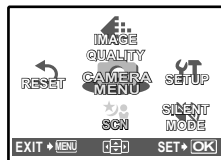

### 1 Set the mode dial to P.

### 2 Press MENU to display the top menu. Select [CAMERA MENU] and press .

- [DIGITAL ZOOM] is on a menu in [CAMERA MENU].  
Press .



### 3 Press to select [DIGITAL ZOOM], and press .

- Unavailable settings cannot be selected.
- When pressing  on this screen, the cursor moves to the page display. Pressing   changes the page. To return to item selection, press  or .

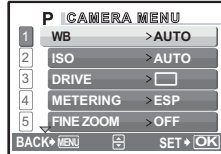

Page display : \_\_\_\_\_  
This mark is displayed when there are more menu items on the next page.

The selected item is displayed \_\_\_\_\_  
in a different color.

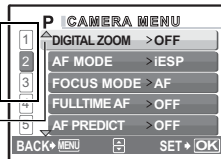

### 4 Press to select [OFF] or [ON], and press .

- The menu item is set and the previous menu is displayed. Press **MENU** repeatedly to exit the menu.
- To cancel changes and continue menu operation, press **MENU** before pressing .

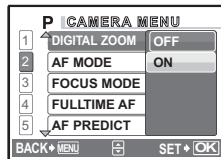



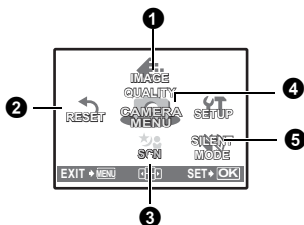

## Shooting mode menu

## AUTO P A/S M SCN



### 4 CAMERA MENU

WB	 FLASH
ISO	 (still pictures)
DRIVE	PANORAMA *1
METERING	<b>WB7</b>
FINE ZOOM	SHARPNESS
DIGITAL ZOOM	CONTRAST
AF MODE	SATURATION
FOCUS MODE	NOISE REDUCT.
FULLTIME AF	TIMELAPSE
AF PREDICT	 (movies)
DIS MODE	DIS MOVIE MODE
	
 SYNCRO	

\*1 An OLYMPUS xD-Picture Card is required.

- Some functions are not available according to the selected mode.
- ☞ “Functions available in shooting modes and scenes” (P. 72)
- ☞ “SETUP menus” (P. 39)
- The factory default settings are displayed in gray (  ).

## 1 IMAGE QUALITY

### Changing the image quality

#### Still picture image quality and their applications

- Normal image modes

Image quality/Image size	Compression	Application
SHQ 3072 × 2304	Low compression	• This is useful for printing large images on full-size paper.
HQ 3072 × 2304	Standard compression	• This is useful for performing computer image processing, such as contrast adjustment and red-eye correction.
SQ1 <sup>*1</sup> 2560 × 1920	Low compression (High quality) / Standard (Standard compression)	• This is useful for printing on full-size paper. • This is useful for computer editing such as rotating or adding text to a picture.
2304 × 1728		
2048 × 1536		
SQ2 <sup>*1</sup> 1600 × 1200	Low compression (High quality) / Standard (Standard compression)	• This is useful for postcard-sized prints. • This is useful for viewing pictures on a computer. • This is useful for sending as e-mail attachments.
1280 × 960		
1024 × 768		
640 × 480		

\*1 If you select [SQ1] or [SQ2], select [HIGH] or [STANDARD] after selecting the image size.



- Special record modes

Image quality/Image size	Application
RAW 3072 × 2304	• Raw uncompressed data. • Data is in ORF format.
3:2 <sup>*2</sup> (SHQ, HQ) 3072 × 2048	• This is useful for ordering prints from a photo store.

\*2 Not displayed when set to **AUTO**, **SCN**.

#### JPEG copy

Pictures taken in the raw data format can be stored in JPEG format at the same time as they are recorded in raw data. To record pictures in JPEG format you can select [SHQ], [HQ], [SQ1] or [SQ2] for the record mode, but you cannot select the image size. Pictures are recorded in the size currently set for each record mode.

- In the [IMAGE QUALITY] screen, select [RAW], and press .
- Select a JPEG duplicate setting from [OFF], [SHQ], [HQ], [SQ1] and [SQ2] and press . (Select [OFF] to save raw data only.)

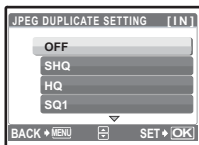

## Movie image quality

Image quality/lange size	Number of frames
SHQ 640 × 480	30 frames/sec.
HQ 640 × 480	15 frames/sec.
SQ1 320 × 240	30 frames/sec.
SQ2 320 × 240	15 frames/sec.

## 2 RESET

Change the shooting functions back to default settings

NO /YES

It restores shooting functions back to default settings. The mode dial must not be set to **GUIDE**.

Functions for returning the settings to the original when the reset function is executed

Function	Factory default setting	Ref. Page
FLASH	AUTO	P. 17
	OFF	P. 16
	OFF	P. 16
	0.0	P. 16
IMAGE QUALITY	HQ	P. 20
WB	AUTO	P. 22
ISO	AUTO	P. 23
DRIVE		P. 23
METERING	ESP	P. 24
FINE ZOOM	OFF	P. 24
DIGITAL ZOOM	OFF	P. 24
AF MODE	iESP	P. 24
FOCUS MODE	AF	P. 25
FULLTIME AF	OFF	P. 25

Function	Factory default setting	Ref. Page
AF PREDICT	OFF	P. 25
DIS MODE	OFF	P. 25
	0.0	P. 26
SYNCRO	SYNC1	P. 26
FLASH	IN	P. 26
(still pictures)	OFF	P. 26
	±0	P. 27
SHARPNESS	±0	P. 27
CONTRAST	±0	P. 28
SATURATION	±0	P. 28
NOISE REDUCT.	OFF	P. 28
(movies)	ON	P. 29
DIS MOVIE MODE	OFF	P. 29
Monitor/Viewfinder (IOI)	Monitor	P. 10

## 3 SCN (Scene) Shooting pictures by selecting a scene according to the situation

PORTRAIT / LANDSCAPE / LANDSCAPE+PORTRAIT / SPORT / NIGHT SCENE<sup>1</sup> /  
 NIGHT+PORTRAIT<sup>1</sup> / INDOOR / CANDLE / SELF PORTRAIT / AVAILABLE LIGHT /  
 SUNSET / FIREWORKS<sup>1</sup> / MUSEUM / CUISINE / BEHIND GLASS / DOCUMENTS /  
 AUCTION / SHOOT & SELECT1<sup>2</sup> / SHOOT & SELECT2<sup>3</sup> / BEACH / SNOW

The scene selection screen displays sample images and the shooting mode to best suit the situation.

It can be set only when the mode dial is set to **SCN**.

- By switching to the other scene, most settings will be changed to the default settings of each scene.

\*1 When the object is dark, noise reduction is automatically activated. This approximately doubles the shooting time, during which no other pictures can be taken.

\*2 The focus is locked at the first frame.

\*3 During sequential shooting, the camera focuses for each frame.

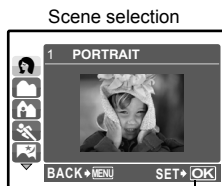

Press to decide the scene.

## [ SHOOT & SELECT1] / [ SHOOT & SELECT2]

- Press and hold the shutter button to shoot sequential pictures. After shooting pictures, select the ones you want to erase, put to them, and press to erase them.

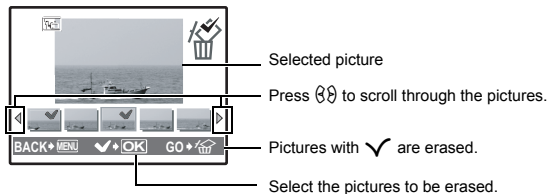



## 4 CAMERA MENU

### WB ..... Adjusting the color of a picture

AUTO		Adjusts the white balance automatically for natural color, regardless of the light source.
PRESET		Selects the white balance according to the light source.
	Sunny day	For shooting under a clear sky.
	Cloudy day	For shooting under a cloudy sky.
	Tungsten light	For shooting under tungsten lighting.
	Fluorescent lamp 1	For shooting under daylight fluorescent lighting. (This type of lamp is mainly used in homes.)
	Fluorescent lamp 2	For shooting under a neutral white fluorescent lamp. (This type of lamp is mainly used in desk lamps.)
	Fluorescent lamp 3	For shooting under a white fluorescent lamp. (This type of lamp is mainly used in offices.)
	One touch WB	For setting a more precise white balance than preset white balance can provide. You can set and save the optimum white balance for the shooting conditions.

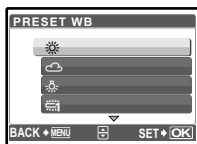
## When [PRESET] is selected



Press  to select a white balance setting, then press .

## When [ONE TOUCH WB] is selected

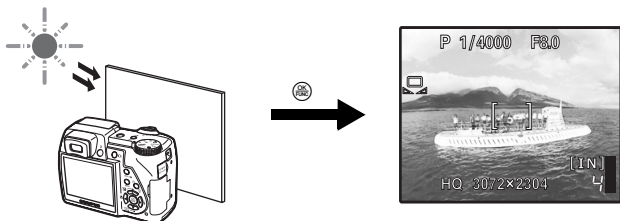





- With the [ONE TOUCH WB] screen displayed, point the camera at a sheet of white paper. Position the paper so that it fills the screen, making sure there are no shadows.
- Press . The new white balance is set.

## ISO ..... Changing the ISO sensitivity





AUTO	Sensitivity is automatically adjusted according to the conditions of the subject.
50/100/200/ 400/800/1600/ 2500/4000	A low value lowers the sensitivity for daylight shooting of clear, sharp pictures. The higher the value, the better the camera's light sensitivity and ability to shoot with a fast shutter speed and in low light conditions. However, high sensitivity introduces noise into the resulting picture, which may give it a grainy appearance.

- If set to over [2500], [IMAGE QUALITY] is limited to below [2048 x 1536].

## DRIVE ..... Continuous shooting

	Shoots 1 frame at a time when the shutter button is pressed.
	Focus and exposure are locked at the first frame. The sequential shooting speed varies depending on the setting of record mode.
	Takes pictures at a faster speed than normal sequential shooting.
	Adjusts the focus 1 frame at a time. The shooting speed is slower than for normal sequential shooting.
BKT	Takes pictures sequentially while changing the exposure for each frame. Focus and white balance are locked at the first frame.

You can take a sequence of pictures at one time while holding down the shutter button. The camera will take pictures in sequence until you release the shutter button.

- In high speed sequential shooting, flash will be limited to .
- Only  is available when [NOISE REDUCT.] is set to [ON].
- ,  and [BKT] are not available when record mode is set to [RAW].

## When [BKT] is selected

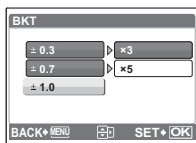

Exposure differential     $\pm 0.3 / \pm 0.7 / \pm 1.0$

Number of frames         $\times 3 / \times 5$

- Press the shutter button completely and keep it pressed to shoot the preset number of pictures. You can stop shooting at any time by releasing the shutter button.

## METERING ..... Changing the area for measuring the brightness of a subject

ESP	Meters the brightness at the center of the monitor and the surrounding area separately to create a picture with balanced brightness. When taking pictures against strong backlight, the center of the picture may appear dark.
<input type="radio"/>	Only the center of the monitor is metered. Suitable for taking a picture of the subject in the center of the monitor against backlight.
<input checked="" type="radio"/>	Meters the brightness over a wide area with emphasis on the center of the screen. This method is used when you do not want to allow surrounding light to affect the picture.

## FINE ZOOM ..... Zooming in on your subject without degrading the image quality

OFF / ON

This function allows you to zoom up to 15x by combining the optical zoom and image cropping.  
 • [IMAGE QUALITY] is limited to below [2048 × 1536].

## DIGITAL ZOOM ..... Zooming in on your subject

OFF / ON

The digital zoom can be used to take close-up pictures with stronger magnification than the optical zoom.

Optical zoom

Digital zoom

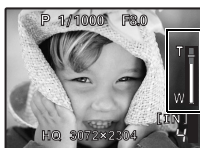

Zoom bar  
 White area: The optical zoom area  
 Red area: The digital zoom area

Maximum magnification

Still picture shooting mode: Optical zoom × digital zoom : Max. 50x



Movie shooting mode:        Optical zoom × digital zoom : Max. 30x

## AF MODE ..... Changing the focusing area

iESP	The camera determines which subject within the screen to focus on. Even when the subject is not in the center of the screen, focusing is possible.
SPOT	Focus selection is based on the subject within the AF target mark.
AREA	Move the AF target mark to select the area you want to focus on to take a picture.







**When [AREA] is selected**

- To move the AF target mark  
Press the arrow pad (the AF target mark is displayed in green).  
You can take pictures while in this status.
- To set the position of the AF target mark  
Hold down .  
To change the position of the mark, hold down  again.

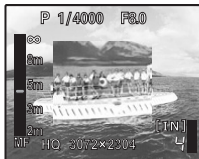
**FOCUS MODE** ..... **Changing the focus method**



AF	Press the shutter button halfway. The camera automatically focuses.
MF	Adjust the focus manually.

**When set to [MF]**

- Press   to set the focus. During operation, the focus area is enlarged. This lets you check whether the focus area is correct.
- Hold down  to fix the focus. The focus is locked at the distance you have set, and MF is displayed in red on the monitor. To adjust the focus, hold down  again.

**FULLTIME AF** ..... **Shooting pictures while keeping the subject in focus**

OFF	Press the shutter button halfway to focus.
ON	Fulltime AF keeps the subject in front of the lens in focus at all times, without having to press the shutter button halfway. The focusing time is reduced, so you will not miss snapshot opportunities. Also, the subject is automatically kept in focus during movie recording.

- [FULLTIME AF] cannot be used when  is set to [ON] in  mode.

**AF PREDICT** ..... **Shooting pictures with the focus on subjects moving back and forth**

OFF	AF predict is deactivated.
ON	After setting, position the AF target mark on the subject, and press the shutter button halfway, then shoot.

-  blinks and AF predict continues to operate while the shutter button is pressed halfway.
- Depending on the subject, the picture may be out of focus even if [AF PREDICT] is set.
- During macro and super macro mode, AF predict is not available.

**DIS MODE** ..... **Shooting still pictures using digital image stabilization**

This function reduces the blur incurred by camera movement or subject movement when taking pictures.

OFF	Digital image stabilization is deactivated.
ON	Digital image stabilization is activated.

- When shooting a dark subject, high ISO sensitivity introduces noise into the resulting picture, which may give it a grainy appearance.

**[F]** ..... **Adjusting the amount of light emitted by the flash**

Adjusts the amount of light emitted by the flash in the following situations:

Shooting small subjects / Distant backgrounds / Situations when increased contrast is desired

+2.0EV to 0.0 to -2.0EV

Press  $\curvearrowright$   $\curvearrowleft$  to adjust, and press  $\text{OK}$ .

**[Z]** **SYNCR0** ..... **Selecting the flash timing**

**[Z] SYNCR1** The flash fires right after the shutter fully opens (front curtain).

**[Z] SYNCR2** With the rear curtain, the flash fires just before the shutter closes (rear curtain). You can use this setting to create interesting effects in your picture, such as expressing the movement of a car by showing the tail-lights streaming backwards. The slower the shutter speed, the better the effects turn out. If the shutter speed is faster than 1/200, the flash fires automatically with the front curtain.

When the shutter speed is set to 4 sec.

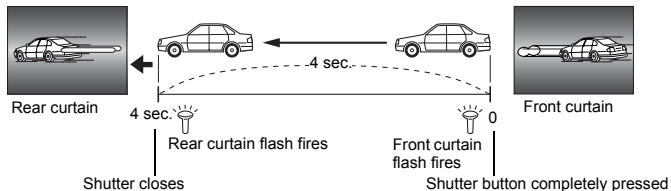
**[M]** **FLASH** ..... **Setting to use an external flash**

**IN** Allows you to take pictures using the built-in flash.

**SLAVE** When using a commercially available slave flash that is synchronized with the camera flash, the amount of the light emitted by the flash can be adjusted in 10 levels.

**Selecting an emission level**

- When flash is set to [SLAVE], flash mode automatically changes to  $\text{[Z]}$  for all flash modes except  $\text{[M]}$ .

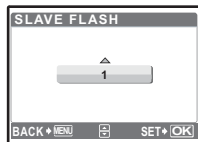

Select an emission level from [1] to [10], then press  $\text{OK}$ . The bigger number indicates the bigger amount of light emitted by the flash.

- The flash can fire in sequential shooting mode, but the interval between shots will be longer if a high emission level is set.

**[M]** **(Still pictures)** ..... **Recording sound with still pictures**

OFF / ON

It automatically starts recording for about 4 seconds after shooting pictures.

During recording, aim the camera microphone at the source of the sound you want to record.

## PANORAMA .....Creating a panoramic picture

Allows you to create a panoramic picture, using the OLYMPUS Master software from the provided CD-ROM. An Olympus xD-Picture Card is required for panorama shooting.

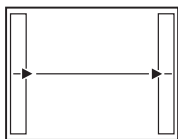

Connects pictures from  
left to right

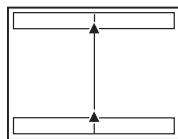

Connects pictures from  
bottom to top

- ☞: The next picture is connected at the right edge.
- ☜: The next picture is connected at the left edge.

- ☒: The next picture is connected at the top.
- ☑: The next picture is connected at the bottom.

Use the arrow pad to specify at which edge you want to connect the pictures, and then compose your shots so that the edges of the pictures overlap. The part of the previous picture where it will be joined to the next picture does not remain in the frame. You have to remember what the part in the frame looked like and take the next picture so it overlaps.

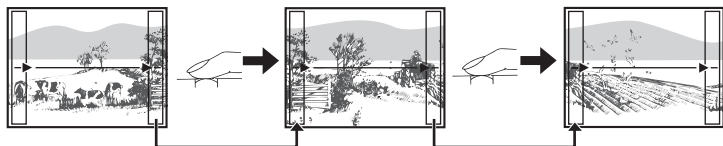

Panorama shooting is possible for up to 10 pictures. Press to exit panorama shooting.

## WB [ ] ..... Adjusting the white balance compensation



The white balance can be adjusted in 7 increments in both the [RED] and [BLUE] directions.

- ☒: Each press makes the color more blue.
- ☑: Each press makes the color more red.

When the white balance is adjusted, press .

## SHARPNESS ..... Adjusting the sharpness of the image

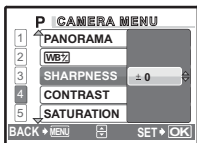

- ☒ (Toward +): The image contours are emphasized, making the image appear sharper and more vivid. Use this setting when you want to print pictures. If you adjust the sharpness too far toward +, noise may become conspicuous in the picture.
- ☑ (Toward -): The image contours are softened. Use this setting when you want to edit images on a computer.

## CONTRAST ..... Adjusting the contrast of the image

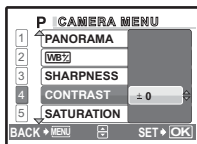

- (Toward +): The light and dark areas are defined more clearly, making the image look crisper.
- (Toward -): The light and dark areas become less defined, giving the image a softer impression. Use this setting when you want to edit images on a computer.

## SATURATION ..... Adjusting the saturation of the image

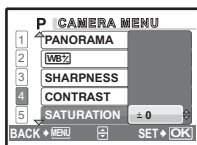

- (Toward +): Colors become stronger.
- (Toward -): Colors become weaker.

## NOISE REDUCT. .... Reducing the noise during long exposures

OFF	Noise is not reduced. Noise may be conspicuous at slow shutter speeds.
ON	Noise is reduced. Shooting time takes twice as long as usual. Shooting is not available during noise reduction. Noise reduction can only be used when the shutter speed is slower than 1/2 sec.

- This function may not work effectively with some shooting conditions or subjects.

## TIMELAPSE ..... Shooting pictures automatically as defined by set conditions

OFF	Timelapse shooting is deactivated.
ON	Timelapse shooting is activated.

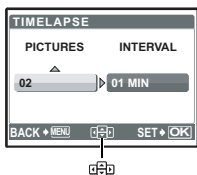

### When setting the timelapse shooting

- Press  $\left(\frac{1}{2}\right)$  to select [PICTURES] and [INTERVAL].
- Press  $\left(\frac{1}{2}\right)$  to set the value.
- Press  $\left(\frac{1}{2}\right)$  to set.
- The first picture is taken when the shutter button is pressed, and the pictures thereafter are automatically taken.
- During timelapse, the  $\left(\frac{1}{2}\right)$  mark lights on the display.
- When recording to either the internal memory or the card, and after the first picture is taken, the camera enters sleep mode. The camera automatically reactivates from sleep mode 4 seconds prior to taking the next picture.
- When the preset number of pictures is taken, the camera automatically turns off.

Number of shots : 2 to 99  
Shooting interval : 1 to 99 minutes in 1 minute intervals

- If you will be taking pictures over a long period, make sure to use fully charged batteries or the AC adapter.

- If any of the following operations occur during sleep mode, the camera cancels the timelapse mode and returns to normal shooting.  
Opening the battery compartment cover, opening the card cover, connecting the camera to a computer, operating the shutter button, arrow pad or other button.
- From 4 seconds prior to taking a picture until the time the picture has been taken, all operation buttons, the mode dial and zoom lever do not function.
- If the internal memory/card becomes full or the battery power runs out during sleep mode, a warning is displayed, timelapse stops and the camera automatically turns off.

 (movies) ..... Recording sound with movies

OFF / ON

- If the camera is more than 1 m (3.3 ft.) away from the source of the sound, sound may not be recorded clearly by the built-in microphone.

**DIS MOVIE MODE** ..... Reducing the blur incurred by camera movement when taking movies

OFF / ON

- The images are recorded slightly larger when [DIS MOVIE MODE] is set to [ON].
- When the camera moves a lot or the subject is moving quickly, the digital image stabilization function may not operate effectively.
- When taking pictures with the camera stabilized, set [DIS MOVIE MODE] to [OFF], otherwise the movement of the subject may cause the image on the screen to move.

**5 SILENT MODE**

Setting to turn off operational sounds

OFF / ON

This function allows you to turn off operational sounds that occur during shooting and playback, warning beeps, shutter sounds, etc.  
It cannot be set when the mode dial is set to **GUIDE**.



**5 EDIT**

- RAW DATA EDIT
- REDEYE FIX
- BLACK & WHITE
- SEPIA
- FRAME
- LABEL
- CALENDAR
- LAYOUT
- LIGHTING FIX
- BRIGHTNESS
- SATURATION
- INDEX
- EDIT
- CAPTURE

When a still picture is selected

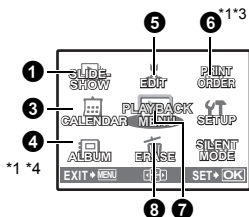

**7 PLAYBACK MENU**

- ALBUM ENTRY<sup>\*1</sup>
- INDEX PLAY

When a movie is selected

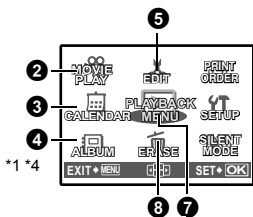

- \*1 A card is required.
- \*2 This is not displayed when a movie is selected.
- \*3 Cannot be selected if a movie is selected.
- \*4 Cannot be selected if no image is registered in the album.

“SETUP menus” (P. 39)

“SILENT MODE Setting to turn off sounds like shutter sound” (P. 29)

- The factory default settings are displayed in gray ( ).

**1 SLIDESHOW**

Playing back pictures automatically

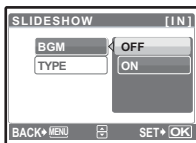

- Set [BGM] to [ON] or [OFF].
- Select the transition effect between pictures from [TYPE].

BGM	ON / OFF
TYPE	NORMAL / SCROLL / FADER / SLIDE / ZOOM DOWN / ZOOM UP / SWIVEL / CHECKER BOARD / BLINDS / RANDOM

- Only the first frame of each movie is displayed.
- After setting [BGM] and [TYPE], press **OK** to start the slideshow.
- Press **BACK** or **MENU** to cancel the slideshow.

## 2 MOVIE PLAY

Playing back movies



Select [MOVIE PLAY] from the top menu, and press to play back the movie.

Another option is to select a picture with the movie icon () , and press to play back the movie.

### Operations during movie playback



Playing time/Total recording time

 : Increases the volume.

 : Reduces the volume.

 : Each time you press the button, the playback speed changes in the following order: 2x; 20x; and back to 1x.

 : Plays the movie in reverse. Each time you press the button, the playback speed changes in the following order: 2x; 20x; and back to 1x.

- Press  to pause the playback.

### Operations during pause



 : Displays the first frame.

 : Displays the last frame.

 : Displays the next frame.

 : Displays the previous frame.

- To resume the movie, press .
- To cancel the playback of the movie in the middle of it or during pause, press **MENU**.

## 3 CALENDAR

Playing back the pictures in a calendar format

Allows you to play back the pictures in a calendar format by the date of recording.

## 4 ALBUM

See the pictures registered in the album

Use the arrow pad to select an album, and press .

Use the arrow pad to display picture you want.

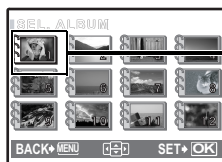



## 5 EDIT

Allows you to edit still pictures saved on a card and store them as new pictures.

### RAW DATA EDIT .....Editing the pictures recorded in raw data format

Adjusts the pictures recorded in raw data format and stores them as new pictures in JPEG format. Items that can be set with [RAW DATA EDIT].

Item	Settings	Ref. Page
IMAGE QUALITY	SHQ, HQ, SQ1, SQ2	P. 20
WB	AUTO, PRESET, 	P. 22
 WB	RED7 - BLUE7	P. 27
SHARPNESS	-5 - +5	P. 27
CONTRAST	-5 - +5	P. 28
SATURATION	-5 - +5	P. 28

\* Available only when the picture is taken with [WB] set to .

### ..... Changing the size of pictures



640 × 480 / 320 × 240

Changes the image size of a picture and saves it as a new file.

### ..... Cropping a part of pictures

Designates and crops part of a still picture and saves it as a new file.



- Press  to select the image to crop, and press .
- Use the arrow pad and the zoom lever to set the position and size of the picture, and press .

### REDEYE FIX ..... Fixing the red-eye in pictures

Corrects the red-eye look that often occurs when taking pictures with a flash and saves it as a new file.

### BLACK & WHITE ..... Changing pictures to black and white

Changes the picture to black and white and saves it as a new file.

### SEPIA ..... Changing pictures to a sepia tone

Changes the picture to sepia and saves it as a new file.



## FRAME.....Synthesize the frame and the picture

Allows you to select the frame, and synthesize the frame and the picture, and store it as a new picture.



- Select a frame with  $\left(\right)$  and press  $\left(\right)$ .
- Select the picture to be synthesized with the frame with  $\left(\right)$ , and press  $\left(\right)$ . (Press  $\left(\right)$  to turn the picture 90 degrees clockwise or 90 degrees counterclockwise.)
- Use the arrow pad and the zoom lever to adjust the position and size of the picture, and press  $\left(\right)$ .

## LABEL..... Add a label to your picture

Allows you to select the label, synthesize the title and the picture, and store it as a new picture.



- Select the picture with  $\left(\right)$ , and press  $\left(\right)$ .
- Select the title with  $\left(\right)$ , and press  $\left(\right)$ . (Press  $\left(\right)$  to turn the title 90 degrees clockwise or 90 degrees counterclockwise.)
- Use the arrow pad and the zoom lever to adjust the position and size of the picture, and press  $\left(\right)$ .
- Set the color of the title with the arrow pad, and press  $\left(\right)$ .

## CALENDAR ..... Synthesize the calendar using the picture

Allows you to select the calendar, synthesize the calendar and the picture, and store it as a new picture.

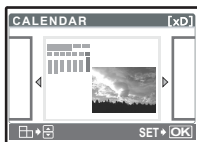

- Select the picture with  $\left(\right)$ , and press  $\left(\right)$ .
- Select the calendar with  $\left(\right)$ , and press  $\left(\right)$ . (Press  $\left(\right)$  to turn the picture 90 degrees clockwise or 90 degrees counterclockwise.)
- Set the date of the calendar, and press  $\left(\right)$ .

## LAYOUT ..... Creating an index layout of pictures

ALL IMAGES	All pictures in the internal memory or the card are added to the layout.
ALBUM	All pictures in the selected album are added to the layout.
CALENDAR	Select the pictures you want to add to the layout by day from the monthly display.
SEL. IMAGE	Select the pictures to be added to the layout individually.

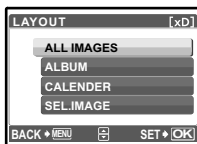

- Press  $\left(\right)$  to select a layout, and press  $\left(\right)$ .
- Select the type of layout picture, and press  $\left(\right)$ .
- Select the pictures and press  $\left(\right)$ . (When [SEL. IMAGE] is selected in [LAYOUT] screen, press  $\left(\right)$  to rotate the picture 90° clockwise or counterclockwise.)

**LIGHTING FIX** ..... **Controlling the lighting of the picture**

Allows you to control the tone of the whole picture so that the dark part becomes brighter and store it as a new picture.

**BRIGHTNESS** ..... **Change the brightness of the picture**

Allows you to adjust the brightness of the picture, and store it as a new picture.

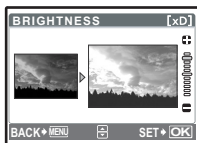

- Select the picture with  $\leftarrow \rightarrow$ , and press  $\left[ \text{OK} \right]$ .
- Adjust the brightness with  $\infty \infty$ , and press  $\left[ \text{OK} \right]$ .

**SATURATION** ..... **Change the vividness of the picture**

Allows you to adjust the vividness of the picture, and store it as a new picture.

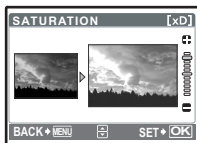

- Select the picture with  $\leftarrow \rightarrow$ , and press  $\left[ \text{OK} \right]$ .
- Adjust the vividness with  $\infty \infty$ , and press  $\left[ \text{OK} \right]$ .

**INDEX** ..... **Making an index picture from a movie**

Allows you to extract 9 frames from a movie and saves them as a new picture (INDEX).



- Use  $\leftarrow \rightarrow$  to select a movie and press  $\left[ \text{OK} \right]$ .
- Use the arrow pad to select the first frame of the part you want to keep, and press  $\left[ \text{OK} \right]$ . In the same manner, select the last frame of the part you want to keep and press  $\left[ \text{OK} \right]$ .

**EDIT** ..... **Extracting a part of the movie**

Allows you to specify a part of the movie and overwrite it, or save it as a new movie.



- Select [NEW FILE] or [OVERWRITE], and press  $\left[ \text{OK} \right]$ .
- Use the arrow pad to select the first frame of the part you want to keep, and press  $\left[ \text{OK} \right]$ . In the same manner, select the last frame of the part you want to keep, and press  $\left[ \text{OK} \right]$ .

**CAPTURE** ..... **Capturing a still image from the movie**

Allows you to capture a still image from the movie, which is taken with the [IMAGE QUALITY] set to [SHQ] or [HQ], and record it in JPEG format.



- Press  $\leftarrow$  to select a movie, and press  $\left[\text{D}\right]$ .
- Use the arrow pad to select the frame to capture, and press  $\left[\text{D}\right]$ .

## 6 PRINT ORDER

### Making print reservations (DPOF)

Allows you to save printing data (the number of prints and the date and time information) with the pictures stored on the card.

$\left[\text{MENU}\right]$  "Print settings (DPOF)" (P. 49)

## 7 PLAYBACK MENU

$\left[\text{ON}\right]$  ..... Protecting pictures

OFF / ON



Protected pictures cannot be erased with [ERASE]/[SEL. IMAGE]/[ALL ERASE], but they are all erased by formatting.

- Select the picture with  $\leftarrow$ , and protect it by selecting [ON] with  $\left[\text{ON}\right]$ .
- You can protect several frames in succession. When a picture is protected,  $\left[\text{ON}\right]$  is displayed on the monitor.

$\left[\text{ROT}\right]$  ..... Rotating pictures

+90° / 0° / -90°

Pictures taken with the camera held vertically are displayed horizontally. This function allows you to turn such pictures so that they are displayed vertically. New picture orientations are saved even when the power is turned off.

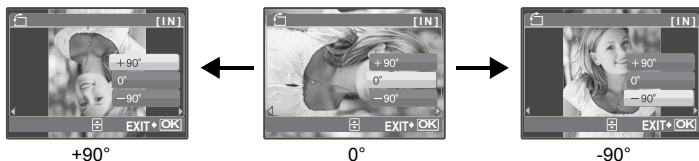

INDEX PLAY ..... Selecting the playback position of the movie



- Use the arrow pad to select a frame.  
Push or pull the zoom lever to change the number of displayed index frames.
- Press .  
Movie playback begins from the selected frame.

#### .....Adding sound to still pictures

YES /NO



Sound is recorded for about 4 seconds.

- Use to select a picture, and use to select [YES] to record.
- The [BUSY] bar is displayed.

#### ALBUM ENTRY .....Adding pictures to an album

Pictures recorded to the card can be organized by sorting them into albums. Pictures stored in the internal memory cannot be entered in albums.

"Album playback menus" (P. 38)

Select the album entry method

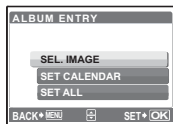

Select an album to add the pictures

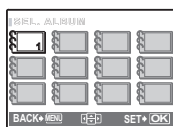

[SEL. IMAGE]



### Select one frame at a time for entry

- Use the arrow pad to select a picture, and press  $\odot$  to add  $\checkmark$ .
- Press  $\odot$  again to cancel the selection.
- When the selection is completed, press  $\odot$  for a while.

[SET CALENDAR]



### Add pictures taken on the same day

Use the arrow pad to select the date with pictures to enter in the album, and press  $\odot$ .

[SET ALL]

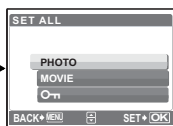

### Select all still images, all protected images, or all movies

## 8 ERASE

Erase selected pictures/Erase all pictures

Protected pictures cannot be erased. Cancel protection before erasing protected pictures. Once erased, pictures cannot be restored. Check each picture before erasing to avoid accidentally erasing pictures you want to keep.

- When erasing the picture in the internal memory, do not insert a card into the camera.
- When erasing the picture from a card, insert the card into the camera in advance.

### SEL. IMAGE..... Erase by selecting the single-frame



- Use the arrow pad to select the picture, and press  $\odot$  to put  $\checkmark$ .
- To cancel the selection, press  $\odot$  again.
- When the selection is completed, press  $\odot$ .
- Select [YES], and press  $\odot$ .

## ALL ERASE ..... Erase all the pictures in the internal memory and the card

- Select [YES], and press

### Album playback menus

- The card on which album is registered is required.
- ☞ “ALBUM ENTRY Adding pictures to an album” (P. 36)

When the still picture is selected

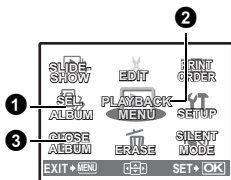

### 2 PLAYBACK MENU

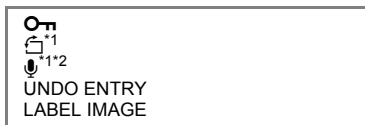

- \*1 This is not displayed when the movie is selected.
- \*2 Cannot be selected when still pictures registered in the album are played back.

When the movie is selected

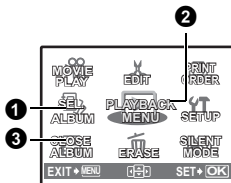

- ☞ “SLIDESHOW Playing back pictures automatically” (P. 30)
- “MOVIE PLAY Playing back movies” (P. 31)
- “Print settings (DPOF)” (P. 49)
- “SETUP menus” (P. 39)
- “ERASE Erase selected pictures/Erase all pictures (P. 37)
- “SILENT MODE Setting to turn off sounds like shutter sound” (P. 29)

### 1 SEL. ALBUM

See other album

To switch albums, select the desired album from [SEL. ALBUM].

- ☞ “ALBUM See the pictures registered in the album” (P. 31)

### 2 PLAYBACK MENU

## UNDO ENTRY ..... Undoing album entries

Even if a picture is removed from an album, the picture remains in the card.

SEL. IMAGE



Select one frame at a time to undo.

- Press the arrow pad to select a picture, and press to add ✓.
- Press again to cancel the selection.
- When the selection is completed, press for a while.

UNDO ALL

Undo all pictures in the album

## LABEL IMAGE ..... Selecting the label image

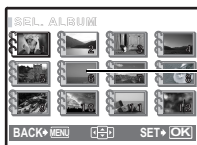

Allows you to change the label image (first frame in the album) to be displayed on the album selection screen.

Label image (first frame in the album)

Other album menus

🔒 "🔒 Protecting pictures" (P. 35)

🖼️ "🖼️ Rotating pictures" (P. 35)

## 3 CLOSE ALBUM

This function exits album playback.

## SETUP menus

Shooting mode

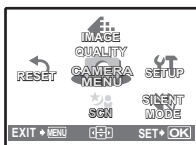

SETUP

MEMORY FORMAT (FORMAT <sup>*1</sup> )	PIXEL MAPPING
BACKUP <sup>*1</sup>	🔌
🔊	🕒
PW ON SETUP <sup>*2</sup>	DUAL TIME
PW OFF SETUP <sup>*2</sup>	ALARM CLOCK
SCREEN SETUP	VIDEO OUT
BEEP <sup>*2</sup>	FRAME ASSIST
🔊 <sup>*2</sup>	📊
SHUTTER SOUND <sup>*2</sup>	MY MODE SETUP
VOLUME <sup>*2</sup>	m/ft
REC VIEW	AF ILLUMINAT.
FILE NAME	CUSTOM BUTTON

Playback mode

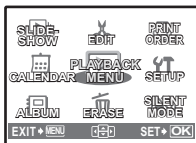

\*1 A card is required.

\*2 The sound is turned off regardless the setting when [SILENT MODE] is set to [ON].

🔒 "🔒 SILENT MODE Setting to turn off operational sounds" (P. 29)

## MEMORY FORMAT (FORMAT) ..... Formatting the internal memory or card

All existing data, including protected pictures, are erased when the internal memory or card is formatted. Make sure that you save or transfer important data to a computer before formatting.

- Make sure there is no card inserted in the camera when formatting the internal memory.
- When the internal memory is formatted, the data of the frames and titles downloaded with the provided OLYMPUS Master software will be deleted.
- Be sure that the card is inserted in the camera when formatting the card.
- Before using non-Olympus cards or cards which have been formatted on a computer, you must format them with this camera.

**BACKUP** ..... Copying pictures in the internal memory to the card

Insert the optional card into the camera. Copying data does not erase the picture in the internal memory.

- It takes some time to back up data. Check if the battery is not empty before starting the copy, or use the AC adapter.

 ..... Selecting a display language

You can select a language for on-screen display. Available languages vary depending on the area where you purchased this camera.

You can add other languages to your camera with the provided OLYMPUS Master software.

**PW ON SETUP/PW OFF SETUP** ..... Setting the startup/shutdown screen and sound

SCREEN	OFF *1	/	1	/	2 *2
SOUND	OFF (No sound)	/	1	/	2

\*1 No picture is displayed.

\*2 The picture registered with [SCREEN SETUP] is displayed.

You can select the types of the sound and the picture displayed when the camera is turned on or off. If [SCREEN] is set to [OFF], [SOUND] cannot be set.

- The factory default setting is set to [OFF] both for [SCREEN] and [SOUND] in [PW OFF SETUP].
- The volume turns to the value set in [VOLUME].

 "VOLUME Adjusting the volume during playback" (P. 40)

**SCREEN SETUP** ..... Registering a picture as the startup screen

Still pictures in the internal memory or the card can be registered to screen [2] for [PW ON SETUP] or [PW OFF SETUP]. If a picture is already registered, a message is displayed asking if you want to cancel the currently registered picture and register a new one.

**BEEP** ..... Adjusting the volume of beep when button is pressed

	OFF (No sound)
1	LOW / HIGH
2	LOW / HIGH

 ..... Adjust the volume of camera warning sound

OFF (No sound) /	LOW	/ HIGH
------------------	-----	--------

**SHUTTER SOUND** ..... Selecting the sound of the shutter button

	OFF (No sound)
1	LOW / HIGH
2	LOW / HIGH

**VOLUME** ..... Adjusting the volume during playback

OFF (No sound) /	1	/ 2	/ 3	/ 4	/ 5
------------------	---	-----	-----	-----	-----



**REC VIEW** ..... **Viewing pictures immediately**

OFF	The picture being recorded is not displayed. This is useful when you want to prepare for your next shot while the previous picture is being recorded.
ON	The picture being recorded is displayed. This is useful for making a brief check of the picture you have just taken. You can resume shooting while the picture is still being displayed.

**FILE NAME** ..... **Resetting the file names of pictures**

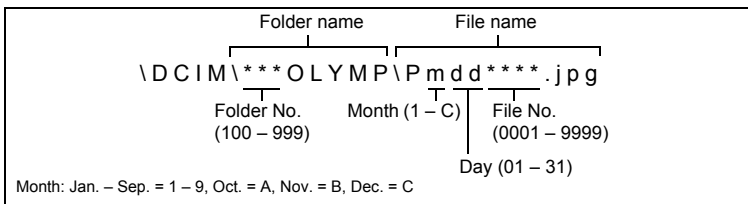

RESET	This method is useful when grouping files on separate cards. The file number and folder number are reset every time a new card is inserted in the camera. The folder number returns to [No. 100] and the file number returns to [No. 0001].
AUTO	This method is useful when you want to manage all your files with sequential numbers. Even if a new card is inserted, the folder number and file number are retained from the previous card. This helps you to manage multiple cards.

File names and their folder names for recorded pictures are automatically generated by the camera. File names and folder names respectively include file numbers (0001 to 9999) and folder names (100 to 999), and are named as follows.

**PIXEL MAPPING** ..... **Adjusting the image processing function**

The pixel mapping feature allows the camera to check and adjust the CCD and image processing functions. It is not necessary to operate this function frequently. Approximately once a year is recommended. Wait at least one minute after taking or viewing pictures to allow the pixel mapping function to perform properly. If you turn the camera off during pixel mapping, start again. Select [PIXEL MAPPING]. When [START] is displayed, press .

 ..... **Adjusting the monitor brightness**

- : Brightens the monitor.
- : Darkens the monitor.

Press  after setting is complete.

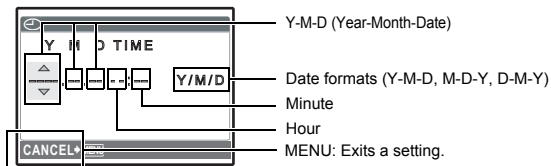

## ..... **Setting the date and time**

The date and time is saved with each image, and is used in the file name.



- The first two digits of [Y] are fixed.
- The time is displayed in the 24-hour format.
- To set the time precisely, with the cursor at either [M] or [Y/M/D], press  as the time signal strikes 00 seconds.

## **DUALTIME** ..... **Setting the date and time in another time zone**

OFF	Switches to the date and time set in  . Pictures are recorded with the date and time set in  .
ON	Switches to the date and time set in [DUALTIME]. When setting the dual time, select [ON], and then set the time. Pictures are recorded with the date and time set in [DUALTIME].

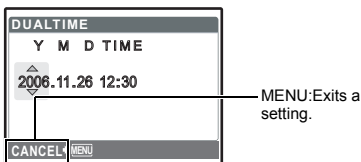

- The date format is the same as that set with .
- The first two digits of [Y] are fixed.
- The time is displayed in the 24-hour format.

## **ALARM CLOCK** ..... **Setting alarms**

OFF	No alarm is set or alarm is canceled.
ONE TIME	Alarm is activated once. After the alarm sounds, the setting is canceled.
DAILY	Alarm is activated daily at the set time.

- When  has not been set, [ALARM CLOCK] is not available.
- When [DUALTIME] is set to [ON], the alarm sounds according to the dual time date and time setting.

### Setting an alarm

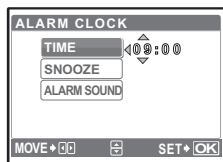

- Select [ONE TIME] or [DAILY], and set the alarm time.
- You can set snooze or alarm sounds and volume.

TIME	Sets the alarm time.
SNOOZE	OFF No snooze is set.
	ON Alarm is activated every 5 minutes, up to 7 times.
ALARM SOUND	1 LOW / MID / HIGH
	2 LOW / MID / HIGH
	3 LOW / MID / HIGH

### Operating, shutting off and checking the alarm

- Operating the alarm:
  - Turn off the camera. The alarm only operates when the camera is off.
- Shutting off the alarm:
  - While the alarm is sounding, press any button to shut off the alarm and turn off the camera. Note that pressing **POWER** will turn the camera on.
  - After 1 minute of no operation, the alarm stops automatically and the camera turns off when [SNOOZE] is set to [OFF].
- Checking the alarm settings:
  - While the camera is off, press **DISP./?** to display the set alarm time and the current time for 3 seconds.

### VIDEO OUT ..... Playing back pictures on a TV

NTSC / PAL

The factory default settings differ according to the region where the camera is sold.

To play back camera images on a TV, set the video output according to your TV's video signal type.

- TV video signal types by country/region Check the video signal type before connecting the camera to the TV.
  - NTSC: North America, Taiwan, Korea, Japan
  - PAL: European countries, China

### Playing back pictures on a TV

Turn off the camera and the TV before connecting.

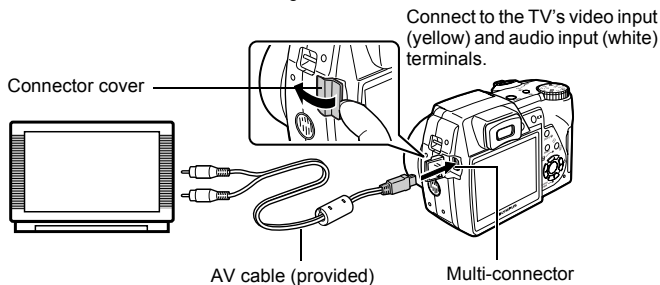

### Settings on the TV

Turn the TV on, and set it to video input mode.

- For details of switching to video input, refer to your TV's instruction manual.

### Settings on the camera

Press **POWER** in playback mode to turn the camera on.

- The last picture taken is displayed on the TV. Use the arrow pad to select the picture you want to display.

## FRAME ASSIST .....Displaying the frame assist/Determining the type of frame assist



Press **DISP./?** in shooting mode to display the frame assist and determine the type of frame assist.

## ..... Displaying the histogram



Press **DISP./?** in shooting mode to display the histogram.

- When set to [DIRECT], the black and white areas are displayed directly on the picture.

## MY MODE SETUP ..... Setting and saving shooting-related functions

### Types of my mode settings

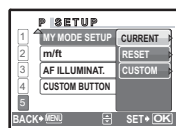

Select a MY MODE to save.

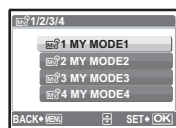

\*Default settings are saved only in [MY MODE 1].

### CURRENT

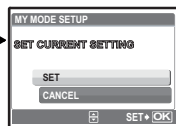

### Saves the current camera settings.

- Select [SET], and press .

### RESET

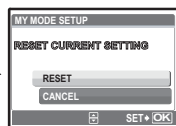

### Restores the factory default settings.

- Select [RESET], and press .
- My mode cannot be selected if no setting is saved.

### CUSTOM

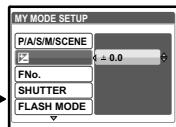

### Saves settings one by one.

- Select the item to save in my mode, and press or .
- Change setting of the item, and press .
- "Functions that can be assigned to My Mode and custom button" (P. 72)

## m/ft ..... Setting the measurement unit during manual focus

m	Displays in meters and centimeters
ft	Displays in feet and inches

**AF ILLUMINAT.** ..... **Setting to light the illuminator in a dark place**

OFF	AF illuminator does not light
ON	Press the shutter button halfway. The AF illuminator automatically lights.

**CUSTOM BUTTON**..... **Assigning functions to the custom buttons**

Press   to select the function you want to set, and press .

 "Functions that can be assigned to My Mode and custom button" (P. 72)

## Direct printing (PictBridge)

### Using the direct printing function

By connecting the camera to a PictBridge-compatible printer, you can print out pictures directly. Select the pictures you want to print and the number of prints on the camera's monitor.

To find out if your printer is compatible with PictBridge, refer to the printer's instruction manual.

#### What is PictBridge?

A standard for connecting digital cameras and printers of different makers and printing out pictures directly.

- Available printing modes, paper sizes etc., vary depending on the printer you use. Refer to the instruction manual for your printer.
- For details of printing paper types, ink cassettes, etc., refer to the printer's instruction manual.

### EASY PRINT

[EASY PRINT] can be used to print out the picture displayed on the monitor.

The selected picture is printed using the standard settings of your printer. The date and file name are not printed.

#### STANDARD

All printers that support PictBridge have standard print settings. If [STANDARD] is selected on the settings screens (P. 48), pictures are printed according to these settings. Refer to the printer's instruction manual for its standard settings or contact the printer manufacturer.

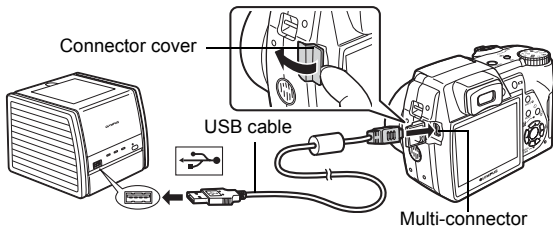

- 1 In playback mode, display the picture you want to print out on the monitor.**
- 2 Turn the printer on and plug the USB cable provided with the camera into the multi-connector of the camera and the printer's USB port.**



- The easy print start screen is displayed.
- For details of how to turn the printer on and the position of the USB port, refer to the printer's instruction manual.

### 3 Press / .

- Printing starts.

- When printing is finished, the picture selection screen is displayed. To print another picture, press  to select a picture, and press .
- When you are finished, disconnect the USB cable from the camera with the picture selection screen displayed.

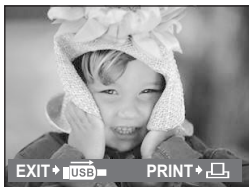
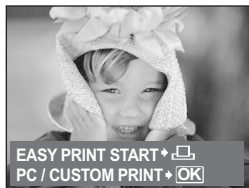

### 4 Remove the USB cable from the camera.

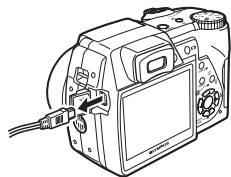

### 5 Remove the USB cable from the printer.

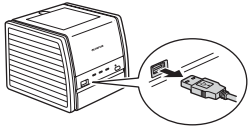

You can use [EASY PRINT] even when the camera is turned off or in shooting mode. With the camera turned off or in shooting mode, connect the USB cable. The selection screen for the USB connection is displayed. Select [EASY PRINT].

 "EASY PRINT" Step 3 (P. 47), "CUSTOM PRINT" Step 2 (P. 47)

## Other print modes and print settings (CUSTOM PRINT)

1 Display the screen being indicated on the right according to the procedure 1 and 2 in P. 46, and press .

2 Select [CUSTOM PRINT], and press .

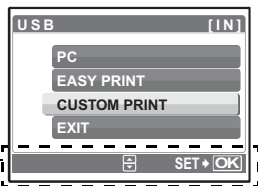

Operation guide

### 3 Make the print settings according to the operation guide.

#### Selecting the picture to print

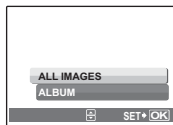

<b>ALL IMAGES</b>	Allows you to select from all pictures to print.
<b>ALBUM</b>	Select an album and the pictures in the album to print (available only when a card is inserted).

#### Selecting a print mode

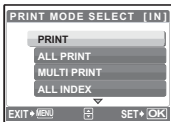

<b>PRINT</b>	Prints the selected picture.
<b>ALL PRINT</b>	Prints all the pictures stored in the internal memory or the card.
<b>MULTI PRINT</b>	Prints one picture in multiple layout format.
<b>ALL INDEX</b>	Prints an index of all the pictures stored in the internal memory or the card.
<b>PRINT ORDER</b>	Prints the pictures according to the print reservation data on the card. If no print reservations have been made, this option is not available. ☞ "Print settings (DPOF)" (P. 49)

#### Setting the print paper

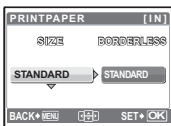

<b>SIZE</b>	Choose from the available paper sizes on your printer.
<b>BORDERLESS</b>	Select framed or unframed. In [MULTI PRINT] mode, you cannot select the frame. <b>OFF</b> ( <input type="checkbox"/> ) The picture is printed inside a blank frame. <b>ON</b> ( <input type="checkbox"/> ) The picture is printed filling the entire page.
<b>PICS/SHEET</b>	Available in [MULTI PRINT] mode only. The number of prints that can be printed vary depending on the printer.

#### ! Note

- If the [PRINTPAPER] screen is not displayed, [SIZE], [BORDERLESS] and [PICS/SHEET] are set to the standard.

#### Selecting the picture to print



<b>PRINT</b>	Prints one copy of the selected picture. When [SINGLE PRINT] or [MORE] has been selected, a single copy or more copies are printed.
<b>SINGLE PRINT</b>	Makes a print reservation for the displayed picture.
<b>MORE</b>	Sets the number of prints and data to be printed for the displayed picture.

Press to select the picture you want to print. You can also use the zoom button and select a picture from the index display.



## Setting the number of prints and data to be printed

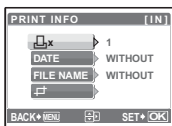

	Sets the number of prints. You can select up to 10 prints.
DATE (🕒)	If you select [WITH], pictures are printed with the date.
FILE NAME (📄)	If you select [WITH], pictures are printed with the file name.
	Use the arrow pad or the zoom lever to adjust trimming size and position, and press . The trimmed picture is printed.

### 4 Select [OK], and press .

- Printing starts.
- When printing is finished, the [PRINT MODE SELECT] screen is displayed.

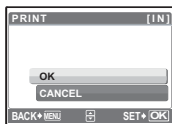

#### To cancel printing

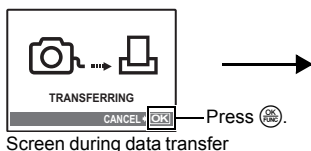

Screen during data transfer

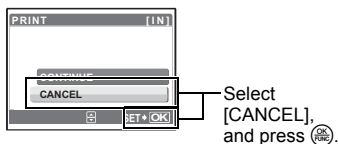

### 5 In the [PRINT MODE SELECT] screen, press MENU.

- A message is displayed.

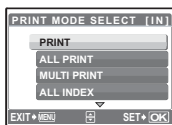

### 6 Disconnect the USB cable from the camera.

### 7 Disconnect the USB cable from the printer.

## Print settings (DPOF)

### How to make print reservations

Print reservation allows you to save printing data (the number of prints and the date and time information) with the pictures stored on the card. With print reservation, you can print out pictures easily either at home using a personal DPOF-compatible printer or at a photo store that supports DPOF. DPOF is a standard format used to record automatic print information from digital cameras.

Only the images stored on the card can be reserved to print. Insert a card with recorded pictures into the camera before making print reservations.

Pictures with print reservations can be printed using the following procedures.

### Printing using a DPOF-compatible photo store.

You can print the pictures using the print reservation data.

### Printing using a DPOF-compatible printer.

Printing is possible directly from a card containing print reservation data, without using a computer. For more details, refer to the printer's instruction manual. A PC card adapter may also be necessary.

## ! Note

- DPOF reservations set by another device cannot be changed by this camera. Make changes using the original device. If a card contains DPOF reservations set by another device, entering reservations using this camera may overwrite the previous reservations.
- You can make DPOF print reservations for up to 999 images per card.
- Not all functions may be available on all printers, or at all photo stores.

### To use print services without using DPOF

- Pictures stored in the internal memory cannot be printed at a photo store. The pictures need to be copied to a card before taking them.  
☞ "BACKUP Copying pictures in the internal memory to the card" (P. 40)

## Single-frame reservation

Follow the operation guide to make a print reservation for a selected picture.



**1 Press MENU in the playback mode and display the top menu.**

**2 Select [PRINT ORDER] ▶ [OK], and press .**

- Playing back the album: Top menu ▶ [PRINT ORDER] ▶ [OK]

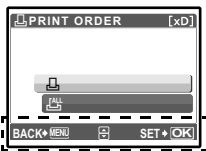
Operation guide



**3 Press  to select the frames for print reservations, and then press  to set the number of prints.**

- You cannot make print reservations for pictures with .
- Repeat Step 3 to make print reservations for other pictures.

### To trim the picture

- Use the zoom lever to display the trimming line.
- Use the arrow pad or the zoom lever to adjust trimming size and position, and press .



**4 When you finish making print reservations, press .**

**5 Select the date and time print setting, and press**

.

**NO** The pictures are printed without the date and time.

**DATE** The selected pictures are printed with the shooting date.

**TIME** The selected pictures are printed with the shooting time.

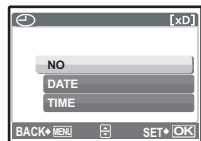



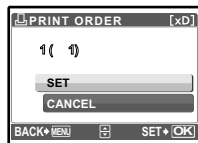

- 6 Select [SET], and press .



## All-frame reservation

Reserves all the pictures stored on the card. The number of prints is set at one print per picture.





- 1 Press MENU in the playback mode and display the top menu.
- 2 Select [PRINT ORDER] ▶ , and press .
  - Playing back the album: Top menu ▶ [PRINT ORDER] ▶ 
- 3 Select the date and time setting, and press .
  - NO The pictures are printed without the date and time.
  - DATE All pictures are printed with the shooting date.
  - TIME All pictures are printed with the shooting time.
- 4 Select [SET], and press .

## Resetting print reservation data

You can reset all the print reservation data or just for selected pictures.







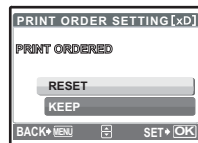

- 1 Select top menu ▶ [PRINT ORDER], and press .
  - Playing back the album: Top menu ▶ [PRINT ORDER]

### To reset the print reservation data for all the pictures

- 2 Select  or , and press .
- 3 Select [RESET], and press .



### To reset the print reservation data for a selected picture

- 2 Select , and press .
- 3 Select [KEEP], and press .
- 4 Press  to select the picture with the print reservations you want to cancel, and press  to decrease the number of prints to 0.
  - Repeat Step 4 to cancel print reservations for other pictures.
- 5 When you are finished canceling print reservations, press .
- 6 Select the date and time setting, and press .
  - The setting is applied to the remaining pictures with print reservations.
- 7 Select [SET], and press .

# Using OLYMPUS Master

## Flow

Using the USB cable provided with your camera, you can connect the camera and computer and download (transfer) the images to your computer using the OLYMPUS Master software, also provided with the camera.

Prepare the following items before starting.



OLYMPUS Master CD-ROM



USB cable

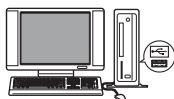

Computer equipped with a USB port

Install the OLYMPUS Master software P. 53

Connect the camera to the computer using the USB cable P. 55

Start up the OLYMPUS Master software P. 56

Download image files to the computer P. 57

Disconnect the camera from the computer P. 57

## Using OLYMPUS Master

### What is OLYMPUS Master?

OLYMPUS Master is application software for editing images taken with a digital camera on a computer. Installing it on your computer lets you do the following:

- **Download images from the camera or other media**
- **View images and movies**  
You can run a slideshow and play back sound.
- **Manage images**  
You can organize your images using the calendar display. Search the image you want by date or keyword.
- **Edit images**  
You can rotate images, trim them and change the size.
- **Edit images with the filter and correction functions**

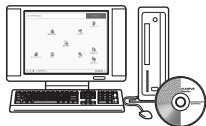

- **Print images**  
You can print images and make indexes, calendars and postcards.
- **Make panoramic images**  
You can make panoramic images using pictures taken in panorama mode.

For details of other functions and operations, refer to the "Help" guide and OLYMPUS Master reference manual.

## Install the OLYMPUS Master software

Before installing the OLYMPUS Master software, please confirm that your computer is compatible with the following system requirements.

For newer operating systems, please refer to the Olympus web site as shown on the back cover of this manual.

### Operating environment

#### Windows

---

OS	Windows 98SE/Me/2000 Professional/XP
CPU	Pentium III 500 MHz or later
RAM	128 MB or more (at least 256 MB is recommended)
Hard disk capacity	300 MB or more
Connector	USB port
Monitor	1,024 × 768 pixels, 65,536 colors or more

#### ! Note

- **Windows 98 is not supported.**
- Data transfer is only guaranteed on computers with a factory installed OS.
- To install the software in Windows 2000 Professional/XP, you must log on as a user with administrators' privileges.
- Internet Explorer and QuickTime 6 or later should be installed on your computer.
- Windows XP corresponds to Windows XP Professional/Home Edition.
- Windows 2000 corresponds to Windows 2000 Professional.
- If you are using Windows 98SE, the USB driver is installed automatically.

#### Macintosh

---

OS	Mac OS X 10.2 or later
CPU	Power PC G3 500 MHz or later
RAM	128 MB or more (at least 256 MB is recommended)
Hard disk capacity	300 MB or more
Connector	USB port
Monitor	1,024 × 768 pixels, 32,000 colors or more

#### ! Note

- **Mac versions earlier than OS X 10.2 are not supported.**
- Operation is only guaranteed on a Macintosh equipped with a built-in USB port.
- QuickTime 6 or later and Safari 1.0 or later must be installed.
- Be sure to remove the media (drag & drop onto the trash icon) before performing the following operations. Failure to do so could result in unstable computer operation and the need to reboot.
  - Disconnect the cable connecting the camera to the computer
  - Turn off the camera
  - Open the camera's battery compartment cover/card cover

#### Windows

### 1 Insert the CD-ROM into the CD-ROM drive.

- The OLYMPUS Master setup screen is displayed.
- If the screen is not displayed, double-click the "My Computer" icon and click the CD-ROM icon.

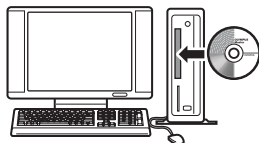

## 2 Click “OLYMPUS Master”.

- The QuickTime installation screen is displayed.
- QuickTime is required to use OLYMPUS Master. If the QuickTime screen is not displayed, QuickTime 6 or later is already installed on the computer. In this case, go to step 4.



## 3 Click “Next” and follow the on-screen instructions.

- When the QuickTime licensing agreement is displayed, read the agreement and click “Agree” to proceed with the installation.
- The OLYMPUS Master installation screen is displayed.

## 4 Follow the on-screen instructions.

- When the OLYMPUS Master licensing agreement is displayed, read the agreement and click “Yes” to proceed with the installation.

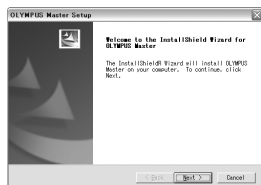

- When the “User Information” dialog box is displayed, enter your “Name” and “OLYMPUS Master Serial Number”; select your region and click “Next”.

**Refer to the sticker on the CD-ROM package for the serial number.**

- When the DirectX licensing agreement is displayed, read the agreement and click “Yes”.
- A screen asking whether or not you want to install Adobe Reader is displayed. Adobe Reader is required to read the OLYMPUS Master instruction manual. If this screen is not displayed, Adobe Reader is already installed on your computer. To install Adobe Reader, click “OK”.

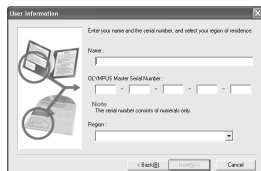

## 5 Follow the on-screen instructions.

- The screen confirming that installation is completed is displayed. Click “Finish”.

## 6 Select the option to restart immediately when the screen asking you if you wish to restart the computer is displayed and click “OK”.

- The computer restarts.
- Remove the CD-ROM from the CD-ROM drive and store it.

## Macintosh

### 1 Insert the CD-ROM into the CD-ROM drive.

- The CD-ROM window is displayed.
- If the CD-ROM window is not displayed, double-click the CD-ROM icon on the desktop.

### 2 Double-click on the desired language folder.

### 3 Double-click the “Installer” icon.

- The OLYMPUS Master installer starts up.
- Follow the on-screen instructions.
- When the OLYMPUS Master licensing agreement is displayed, read the agreement and click “Continue” and then “Agree” to proceed with the installation.
- The screen confirming that installation is completed is displayed.

### 4 Click “Finish”.

- The first screen is displayed.

### 5 Click “Restart”.

- The computer restarts.
- Remove the CD-ROM from the CD-ROM drive and store it.



## Connecting the camera to a computer

### 1 Make sure the camera is turned off.

- The monitor is off.
- The lens is retracted.

### 2 Connect the multi-connector on the camera to the USB port on the computer using the provided USB cable.

- Refer to your computer's instruction manual to locate the position of the USB port.
- The camera turns on automatically.
- The monitor turns on and the selection screen for the USB connection is displayed.

Connector cover

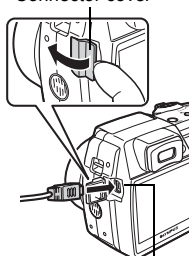

Multi-connector

### 3 Select [PC], and press .

### 4 The camera is recognized by the computer.

#### • Windows

When you connect the camera to your computer for the first time, the computer attempts to recognize the camera. Click “OK” to exit the message that is displayed. The camera is recognized as a “Removable Disk”.

#### • Macintosh

The iPhoto program is the default application for managing digital images. When you connect your digital camera for the first time, the iPhoto application starts automatically, so close this application and start OLYMPUS Master.

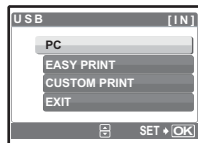

## ! Note

- The camera functions are disabled while the camera is connected to a computer.
- Connecting the camera to a computer via a USB hub may cause unstable operation. In this case, do not use a hub, but connect the camera directly to the computer.

## Start up the OLYMPUS Master software

### Windows

#### 1 Double-click the “OLYMPUS Master” icon on the desktop.

- The main menu is displayed.
- When OLYMPUS Master is started up for the first time after installation, the “Registration” dialog box is displayed before the main menu. Follow the prompts and fill in the registration form.

### Macintosh

#### 1 Double-click the “OLYMPUS Master” icon in the “OLYMPUS Master” folder.

- The main menu is displayed.
- When OLYMPUS Master is started up for the first time, the “User Information” dialog box is displayed before the main menu. Enter your “Name” and “OLYMPUS Master Serial Number”, and select your region. **Refer to the sticker on the CD-ROM package for the serial number.**
- After the “User Information” dialog box, the “Registration” dialog box is displayed. Follow the prompts and fill in the registration form.

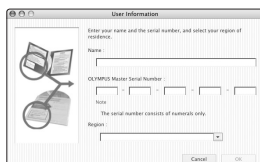

The image shows a 'User Information' dialog box with the following fields: Name, OLYMPUS Master Serial Number (with a 'Show' button), Title, and Region (with a 'List' button). There are 'Cancel' and 'OK' buttons at the bottom right.

### OLYMPUS Master main menu

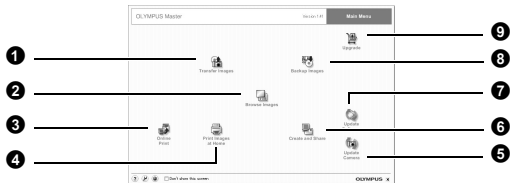

- 1 **“Transfer Images” button**  
Downloads images from the camera or other media.
- 2 **“Browse Images” button**  
The “Browse” window is displayed.
- 3 **“Online Print” button**  
The online print window is displayed.
- 4 **“Print Images at Home” button**  
The print menu is displayed.
- 5 **“Update Camera” button**  
The firmware of the camera can be updated to the latest version. In addition, a display language can be added.
- 6 **“Create and Share” button**  
Displays the editing menu.
- 7 **“Update Software” button**  
OLYMPUS Master can be updated to the latest version.
- 8 **“Backup Images” button**  
Creates backup images.
- 9 **“Upgrade” button**  
Displays window for optional upgrade to OLYMPUS Master Plus.



To exit OLYMPUS Master

**1** Click “Exit”  on the main menu.

- OLYMPUS Master is exited.

## Displaying camera images on a computer

### Downloading and saving images

**1** Click “Transfer Images”  on the OLYMPUS Master main menu.

- The menu for selecting the source is displayed.

**2** Click “From Camera” .

- The window for selecting images is displayed. All the images in the camera are displayed.

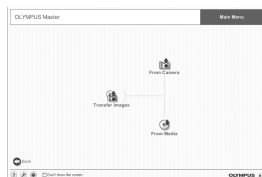

**3** Select the image files and click “Transfer Images”.

- A window indicating that the download is complete is displayed.

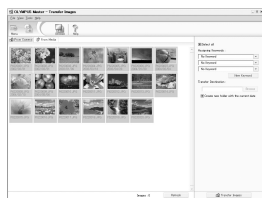

**4** Click “Browse images now.”

- The downloaded images are displayed in the browse window.
- To return to the main menu, click “Menu” in the “Browse” window.

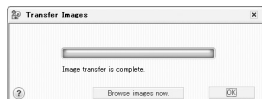

### To disconnect the camera

**1** Make sure that the card access lamp has stopped blinking.

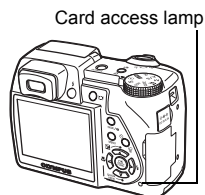

## 2 Make the following preparations for disconnecting the USB cable.

### Windows 98SE

- 1 Double-click the "My Computer" icon and right-click the "Removable Disk" icon to display the menu.
- 2 Click "Eject" on the menu.

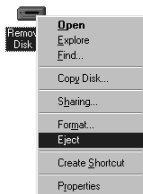

### Windows Me/2000/XP

- 1 Click the "Unplug or Eject Hardware" icon  in the system tray.
- 2 Click the message that is displayed.
- 3 When a message is displayed saying that the hardware can be ejected safely, click "OK".

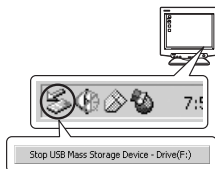

### Macintosh

- 1 The trash icon changes to the eject icon when the "Untitled" or "NO\_NAME" icon on the desktop is dragged. Drag and drop it on the eject icon.



## 3 Disconnect the USB cable from the camera.

### ! Note

- Windows Me/2000/XP: When you click "Unplug or Eject Hardware", a warning message may be displayed. Make sure that image data is not being downloaded from the camera and that all applications are closed. Click the "Unplug or Eject Hardware" icon again and disconnect the cable.

## Viewing still pictures and movies

### 1 Click "Browse Images" on the OLYMPUS Master main menu.

- The "Browse" window is displayed.

### 2 Double-click the still picture thumbnail that you want to view.

Thumbnail

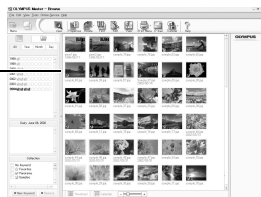

- OLYMPUS Master switches to view mode and the picture is enlarged.
- To return to the main menu, click "Menu" in the "Browse" window.

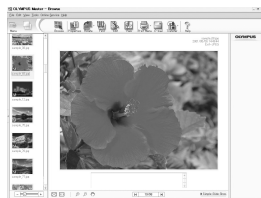

## To view a movie

### 1 Double-click the movie thumbnail that you want to see in the “Browse” window.

- OLYMPUS Master switches to view mode and the first frame of the movie is displayed.

### 2 To play back the movie, click the playback button at the bottom of the screen.

The names and functions of the controller parts are shown below.



Item	Description
1 Playback slider	Move the slider to select a frame.
2 Time display	Displays the time that has elapsed during playback.
3 Playback (pause) button	Plays the movie. Functions as the pause button during playback.
4 Back button	Displays the previous frame.
5 Forward button	Displays the next frame.
6 Stop button	Stops playback and returns to the first frame.
7 Repeat button	Plays the movie repeatedly.
8 Volume button	Displays the volume adjustment slider.

## Printing pictures

Pictures can be printed from the photo, index, postcard and calendar menus. The explanation below uses the photo menu.

### 1 Click “Print Images at Home” on the OLYMPUS Master main menu.

- The print menu is displayed.

### 2 Click “Photo” .

- The “Photo Print” window is displayed.

### 3 Click “Settings” in the “Photo Print” window.

- The printer settings screen is displayed. Make the necessary printer settings.

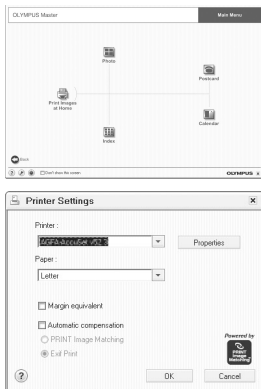

**4 Select a layout and size.**

- To print the date and time with your image, check the box next to "Print Date", and select between "Date" and "Date & Time".

**5 Select the thumbnail image that you want to print and click "Add".**

- A preview of the selected image is displayed on the layout.

**6 Select the number of copies.****7 Click "Print".**

- Printing starts.
- To return to the main menu, click "Menu" in the "Photo Print" window.

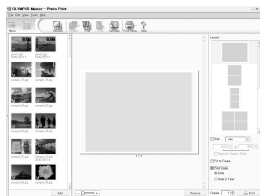

### To download and save images to a computer without using OLYMPUS Master

This camera is compatible with USB mass storage. You can connect the camera to your computer using the USB cable provided with the camera to download and save images without using OLYMPUS Master. The following environment is required to use the USB cable to connect the camera to your computer.

**Windows:** Windows 98SE/Me/2000 Professional/XP

**Macintosh:** Mac OS 9.0 to 9.2/X

**Note**

- If your computer is running Windows 98SE, you will need to install the USB driver. Before connecting the camera to your computer with the USB cable, double-click the files from the following folders on the provided OLYMPUS Master CD-ROM.  
(Drive name): \USB\INSTALL.EXE
- Data transfer is not guaranteed in the following environments, even if your computer is equipped with a USB port.
  - Windows 95/98/NT 4.0
  - Windows 98SE upgrades from Windows 95/98
  - Mac OS 8.6 or earlier
  - Computers with a USB port added by means of an extension card, etc.
  - Computers without a factory-installed OS and home-built computers

### To increase the number of languages

\* Please take care that your battery is fully charged !

**1 Make sure that your PC is connected to the Internet. Click "Update Camera" on the OLYMPUS Master main menu.**

- After selecting the Update Camera function OLYMPUS Master shows a Window with security advices.

**2 Plug the USB cable into the USB port on the computer.**

**3 Plug the other end of the USB cable into the camera's USB connector.**

- The camera turns on automatically.
- The monitor turns on and the selection screen for the USB connection is displayed.

**4 Select [PC], and press .**

**5 Click "OK".**

- OLYMPUS Master will recognize the actual Version of your camera now.
- Click "Check for latest Version" and the Software is searching at the Olympus Homepage for new Camera firmware versions and for additional languages. Then you can select an additional language.

**6 After clicking "Update" OLYMPUS Master is now downloading the new language to your camera. Please do not remove any cable or the battery while the camera is processing.**

**7 After the download procedure the camera display will show OK. You can remove the cables and turn Power OFF. After restarting the camera you will be able to choose the functions in your local language.**

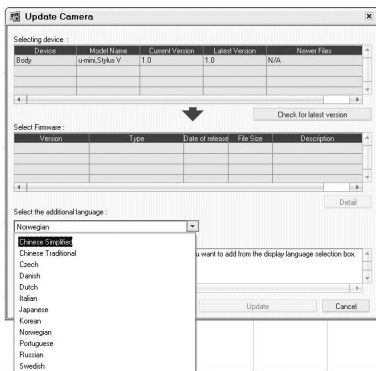
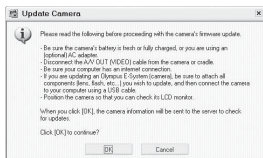

# Getting to know your camera better

## Shooting tips and information

### Tips before you start taking pictures

#### The camera does not turn on even when the batteries are loaded

The battery power is exhausted

- Insert new batteries or charge the batteries.

The battery is temporarily unable to function because of the cold

- Battery performance declines in low temperatures, and the charge may not be sufficient to turn on the camera. Remove the batteries and warm them by putting it in your pocket for a while.

The camera is connected to a computer

- The camera will not operate while it is connected to a computer.

#### No picture is taken when the shutter button is pressed

The camera is in sleep mode

- To save battery power, the camera automatically goes into sleep mode and the monitor turns off if there is no operation when the camera is turned on (when the lens is extended and the monitor is on). No picture is taken even if the shutter button is completely pressed in this mode. Operate the zoom button or other buttons to restore the camera from sleep mode before taking a picture. If the camera is left for 4 hours, it automatically turns off (the lens retracts and the monitor turns off). Press the **POWER** button to turn the camera on.

The mode dial is set to 

- This is the playback mode for displaying pictures on the monitor. Set the mode dial to a shooting mode.

The mode dial is in the position of **GUIDE**

- No pictures can be taken when the shooting guide is being displayed. Take a picture after making the settings following the shooting guide, or turn the mode dial and set it to the position other than **GUIDE** in the shooting mode.

The flash is charging

- Wait until  (flash charge) stops blinking before taking the picture.

The memory gauge is full

- No pictures can be taken when the memory gauge is full. Wait until there is space in the memory gauge.

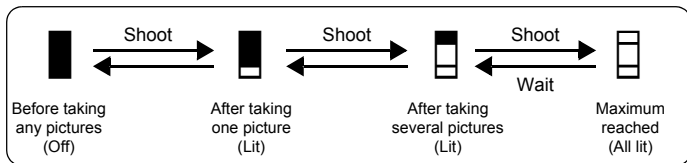

#### The viewfinder does not turn on

The monitor is turned on

- Press  to switch to the viewfinder.

#### The monitor does not turn on

The viewfinder is turned on

- Press  to switch to the monitor.

## The viewfinder or monitor is hard to see

There is condensation\* inside the camera

- Turn the camera off. Before turning it on again, wait until the camera adjusts to the surrounding temperature and dries out.
- \* When it is cold outside, the water vapor in the air is rapidly cooled and turns to droplets of water. Condensation occurs when the camera is suddenly taken from a cold place into a warm room.

Vertical lines appear on the monitor screen during shooting

- Aiming the camera at a bright subject in sunlight may cause vertical lines to appear on the screen. This is not a malfunction.

## The date and time have not been set

The camera has been used in the same conditions from the time of purchase

- No date and time have been set for the camera at the time of purchase. Set the date and time before using the camera.

 "Turn the camera on" (P. 5)

 "Setting the date and time" (P. 42)

The batteries have been removed from the camera

- The date and time settings will be returned to the factory default settings if the camera is left without batteries for approximately 3 days. Before taking important pictures, check that the date and time settings are correct.

## Shooting tips

### Focusing on the subject

There are several ways to focus, depending on the subject.

When the subject is not in the center of the frame

- Place the subject in the center of the frame, lock the focus on the subject, and then recompose your picture.
- Set [AF MODE] to [IESP].

 "AF MODE Changing the focusing area" (P. 24)

The subject is moving quickly

- Focus the camera on a point roughly the same distance away as the subject you want to shoot (by pressing the shutter button halfway), and then recompose your picture and wait for the subject to enter the frame.
- Set the mode dial to **S** to set the shutter speed, and then take the picture. Setting a fast shutter speed lets you capture fast-moving subjects as though they were standing still.

 "**A/S** Changing the aperture value / Changing the shutter speed" (P. 13)

The subject is dark.

- Set [AF ILLUMINAT.] to [ON].

 "AF ILLUMINAT. Setting to light the illuminator in a dark place" (P. 45)

## Subjects that are difficult to focus on

- Under certain types of conditions, it is difficult to focus using auto focus. The green lamp on the monitor lights, allowing you to check if the focus is locked.

The green lamp blinks.  
The subject cannot be brought into focus.



Subject with low contrast



Subject with an extremely bright area in the center of the frame

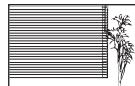

Subject without vertical lines

The green lamp lights, but the subject cannot be brought into focus.



Subjects at different distances

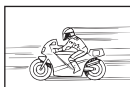

Fast-moving subject



The subject is not in the center of the frame

In these cases, focus (focus lock) on an object with high contrast at the same distance as the intended subject, recompose your shot and then take the picture. If the subject has no vertical lines, hold the camera vertically and focus the camera using the focus lock function by pressing the shutter button halfway, and then return the camera to the horizontal position while keeping the button pressed halfway and take the picture.

## To shoot a stabilized digital image

Hold the camera in a correct posture and press the shutter button slowly. To stabilize the digital image, take pictures with  pressed.

The digital images are not stabilized when:

- images are shot using a zooming function of high magnification, i.e., using both optical zoom and digital zoom functions,
- the object is dark and the shutter speed is slow, or
- the flash cannot be used or when a low shutter speed set **SCN** mode is selected.

## Taking stabilized pictures without the flash

Here is how to take pictures without the flash in this type of situation.

Set the camera to  mode

 “DIS MODE Shooting still pictures using digital image stabilization” (P. 25)

Increase the [ISO] setting

 “ISO Changing the ISO sensitivity” (P. 23)

## The picture is too grainy

There are several factors that can cause the picture to appear grainy.

Using the digital zoom to take close-up pictures

- With the digital zoom, part of the image is cropped and enlarged. The greater the magnification, the grainier the picture appears.

 “DIGITAL ZOOM Zooming in on your subject” (P. 24)



### Increasing the ISO sensitivity

- When you increase the [ISO] setting, "noise", which appears as spots of unwanted color or unevenness in the color, can be introduced and give the picture a grainy appearance. This camera is equipped with a function to allow shooting at high sensitivity while suppressing noise; however, increasing the ISO sensitivity creates grainier pictures than when using a lower sensitivity.



 "ISO Changing the ISO sensitivity" (P. 23)

### Taking pictures with the correct color

- The reason why there are differences between the colors in a picture and the actual colors taken and the actual color is the light source illuminating the subject. [WB] is the function that allows the camera to determine the correct colors. Normally, the [AUTO] setting provides the optimal white balance, but depending on the subject, it may be better to experiment with changing the [WB] setting.
  - When the subject is in the shade on a sunny day
  - When the subject is illuminated by both natural light and indoor lighting, such as when near a window
  - When there is no white in the center of the frame



 "WB Adjusting the color of a picture" (P. 22)

### Taking pictures of a white beach or snow scene

- Take pictures with  or  in **SCN** mode. Suitable for taking pictures on a sunny day at the beach or in the snow.

 "**SCN** (Scene) Shooting pictures by selecting a scene according to the situation" (P. 21)



- Often, bright subjects (such as snow) turn out darker than their natural colors. Adjust  toward [+] to make these subjects closer to their real shades. Conversely, when you are shooting dark subjects, it can be effective to adjust toward the [-]. Sometimes, using the flash may not produce the brightness (exposure) that was intended.

 " button Changing picture brightness" (P. 16)

### Taking pictures of a subject against backlight

- With [METERING] set to , the picture can be taken based on the brightness at the center of the monitor without being affected by the light in the background.

 "METERING Changing the area for measuring the brightness of a subject" (P. 24)

- Set the flash to  to activate fill-in-flash. You can shoot a subject against backlight without the face of the subject appearing dark.  is effective for shooting against backlight and under fluorescent and other artificial lightening.

 " button Flash shooting" (P. 17)

### When the subject is too bright or too dark

- When taking pictures in **S** mode or **A** mode, the shutter speed or aperture setting may be displayed in red. A red display means that the correct exposure cannot be obtained. If you take the picture as is, the picture will appear too bright or too dark. In this case, use the arrow pad to change the settings.

 "A/S Switching aperture priority / shutter speed priority" (P. 17)

## Additional shooting tips and information

### Increasing the number of pictures that can be taken

There are two ways to record the pictures you take with this camera.

#### Recording pictures to the internal memory

- Pictures are recorded to the internal memory, and when the number of storable still pictures reaches 0, you must connect the camera to a computer to download the pictures, and then erase the pictures from the internal memory.

#### Using a card (optional)

- Pictures are recorded to the card when inserted in the camera. When the card is full, you download the pictures to a computer, and then either erase the pictures from the card or use a new card.
- Pictures are not recorded to the internal memory when a card is inserted in the camera. Pictures in the internal memory can be copied to the card using the [BACKUP] function.



"BACKUP Copying pictures in the internal memory to the card" (P. 40)

"The card" (P. 77)

### Number of storable still pictures and recording length of movies

#### Still pictures

Record mode	Image size		Number of storable still pictures			
			Internal memory		Using a 512 MB card	
			With sound	Without sound	With sound	Without sound
RAW	3072 × 2304		2	2	48	48
SHQ	3072 × 2304		4	4	97	98
	3:2 3072 × 2048		4	4	109	109
HQ	3072 × 2304		11	11	275	280
	3:2 3072 × 2048		13	13	307	313
SQ1	2560 × 1920	HIGH	6	6	141	142
		NORMAL	17	17	409	420
	2304 × 1728	HIGH	7	7	174	176
		NORMAL	21	21	499	515
	2048 × 1536	HIGH	9	9	218	221
		NORMAL	26	27	626	652
SQ2	1600 × 1200	HIGH	15	15	354	363
		NORMAL	41	43	968	1030
	1280 × 960	HIGH	22	23	541	560
		NORMAL	61	67	1452	1597
	1024 × 768	HIGH	34	36	819	863
		NORMAL	90	104	2129	2457
	640 × 480	HIGH	79	90	1879	2129
		NORMAL	169	226	3993	5324

Image quality	Image size	Recording length			
		Internal memory		Using a 512 MB card	
		With sound	Without sound	With sound	Without sound
SHQ	640 × 480 (30 frames/sec.)	11 sec.	12 sec.	4 min. 42 sec.	4 min. 43 sec.
HQ	640 × 480 (15 frames/sec.)	23 sec.	24 sec.	9 min. 21 sec.	9 min. 27 sec.
SQ1	320 × 240 (30 frames/sec.)	32 sec.	32 sec.	12 min. 42 sec.	12 min. 54 sec.
SQ2	320 × 240 (15 frames/sec.)	1 min. 03 sec.	1 min. 05 sec.	25 min. 03 sec.	25 min. 48 sec.

- When [IMAGE QUALITY] is set to [SHQ], the maximum sequential shooting time is approximately 15 seconds for the cards other than TypeH.

## Using a new card

- If you use a non-Olympus card or a card used for another application, such as for a computer, the message [CARD ERROR] is displayed. To use this card with this camera, use the [FORMAT] function to format the card.
-  "MEMORY FORMAT (FORMAT) Formatting the internal memory or card" (P. 39)

## Lamp indicators

This camera uses several lamps to indicate the camera status.

Lamp	Status
Self-timer lamp	When set to [⏸ 12 SEC] The lamp lights for approximately 10 seconds, blinks for approximately 2 seconds, and then the picture is taken. When set to [⏸ 2 SEC] The lamp blinks for approximately 2 seconds, and then the picture is taken.
Card access lamp	Blinking: A picture is being recorded, the camera is reading a movie, or images are being downloaded (when connected to a computer). • Do not do any of the following while the card access lamp is blinking. Doing so may prevent the image data from being saved and render the internal memory or card unusable. <ul style="list-style-type: none"> <li>• Open the battery compartment cover/card cover</li> <li>• Remove the batteries.</li> <li>• Connect or disconnect the AC adapter.</li> </ul>
Green lamp of the monitor	Lit: The focus and exposure are locked. Blinking: The focus and exposure are not locked. • Release your finger from the shutter button, re-position the AF target mark on the subject and press the shutter button halfway again.

## Extending the useful life of the battery

- Performing any of the following operations when not actually taking pictures can deplete the battery power.
  - Repeatedly pressing the shutter button halfway
  - Repeatedly using the zoom
  - [FULLTIME AF] is set to [ON].

## Functions that cannot be selected from menus

- Some items may not be selectable from the menus when using the arrow pad.
  - Items that cannot be set with the current shooting mode
  - Items that cannot be set because of an item that has already been set: [S<sup>M</sup>], Flash Mode, etc.
  - Items that cannot be set because the pictures taken by other camera will be edited.
- Some functions cannot be used when there is no card in the camera. [PANORAMA], [PRINT ORDER], [ALBUM ENTRY], [UNDO ENTRY], [LABEL IMAGE], [FORMAT], [BACKUP]

## Selecting the optimal record mode

A record mode expresses a combination of desired image size and compression level. Use the following examples to help determine the optimal record mode when shooting.

To edit and process images on a computer

- [RAW]

To print large images clearly on full-size paper/To edit and process images on a computer

- [SHQ] or [HQ]

To print on full-size paper

- [SQ1]

To print postcard-size image / To send as an e-mail attachment or post on a web site

- [SQ2]

 "IMAGE QUALITY Changing the image quality" (P. 20)

## To return the settings of functions to default settings

- This camera retains a part of the settings even after the power is turned off. To return the settings to default settings, execute [RESET].  
When the mode dial is set to **P**, **A/S**, **M** or : the settings are retained even after the power is turned off (except for the settings of self-timer, panorama and timelapse shootings).  
When the mode dial is set to **AUTO** or **SCN**: the settings return to default (except for [IMAGE QUALITY] and [DIS MODE]).

 "RESET Change the shooting functions back to default settings" (P. 21)

## Confirming the exposure when the monitor is difficult to see outdoors

The monitor may be difficult to see and the exposure difficult to confirm when shooting outdoors.

Press **DISP./** repeatedly to display the histogram

- Set the exposure so that the graph is concentrated on the outer edges and the graph is balanced on both sides.

### How to read the histogram

- ① If the peak fills too much of the frame, the image will appear mostly black.
- ② If the peak fills too much of the frame, the image will appear mostly white.
- ③ The part indicated in green in the histogram shows the luminance distribution within the AF target mark.

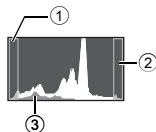

- ☞ “DISP./ button Changing the information on display/Display the menu guide/Checking the time” (P. 15)

## Playback help and troubleshooting tips

### The red-eye cannot be fixed

- Depending on the picture, the red-eye may not be fixed. Also, parts except the eye may be fixed.

### The picture cannot be registered in the album

- Up to 100 pictures can be registered in each album.
- The same picture cannot be registered in several albums.

## Playback tips

### Playing back the picture in the internal memory

- When a card has been inserted in the camera, the picture in the internal memory cannot be played back. Pull out the card before operating the camera.

### Understanding the settings and other information of pictures taken

- Play back a picture, and press **DISP./**. Press **DISP./** repeatedly to change the amount of information displayed.

- ☞ “DISP./ button Changing the information on display/Display the menu guide/Checking the time” (P. 15)

### Quickly displaying a desired picture

- Use the album function. You can create up to 12 albums and enter the pictures on a card to the albums. To view the pictures, set the mode dial to , and then select an album from the top menu to play back.

The same picture cannot be entered in multiple albums.

- ☞ “ALBUM ENTRY Adding pictures to an album” (P. 36)  
“ALBUM See the pictures registered in the album” (P. 31)

- Push the lever toward W to view the pictures as thumbnails (index display) or in a calendar format (calendar display).

- ☞ “Zoom lever Zooming while shooting/close-up playback” (P. 11)

### Erasing sound recorded to still pictures

- Once sound is added to a picture, it is not possible to erase the sound. In this case, make a re-recording with silence. Sound recording is not possible if there is insufficient space in the internal memory or on the card.

- ☞ “ Adding sound to still pictures” (P. 36)

## Viewing pictures on a computer

### Viewing the entire picture on a computer screen

The size of the picture displayed on a computer screen changes depending on the computer settings. When the monitor setting is 1,024 × 768 and you are using Internet Explorer to view a picture with an image size of 2,048 × 1,536 at 100%, the entire picture cannot be viewed without scrolling. There are several ways you can view the entire picture on the computer screen.









View the picture using image browsing software









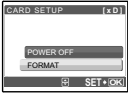

- Install the OLYMPUS Master software from the provided CD-ROM.

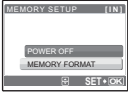
Change the monitor setting

- The icons on the computer desktop may be rearranged. For details of changing the settings on your computer, refer to the computer's instruction manual.

### When you get an error message on the camera...

Monitor indication	Possible cause	Corrective action
 CARD ERROR	There is a problem with the card.	This card cannot be used. Insert a new card.
 WRITE-PROTECT	Writing to the card is prohibited.	The recorded image has been protected (read-only) on a computer. Download the image to a computer and cancel the read-only setting.
 MEMORY FULL	The internal memory has no available memory and cannot store any new data.	Insert a card or erase unwanted data. Before erasing, back up the data of important pictures using the card, or download such pictures to a computer.
 CARD FULL	The card has no available memory and cannot store any new data.	Replace the card or erase unwanted data. Before erasing, download important pictures to a computer.
 NO PICTURE	There are no pictures in the internal memory or on the card.	The internal memory or the card contains no pictures. Record pictures.
 PICTURE ERROR	There is a problem with the selected picture and it cannot be played back on this camera.	Use image processing software to view the picture on a computer. If that cannot be done, the image file is damaged.
 THE IMAGE CANNOT BE EDITED	If pictures taken by other cameras are selected, they cannot be edited.	Use image processing software to edit the pictures.
 CARD-COVER OPEN	The card cover is open.	Close the card cover.
 BATTERY EMPTY	The batteries are empty.	Insert new batteries, or charge the battery.

Monitor indication	Possible cause	Corrective action
	This card cannot be used in this camera. Or, the card is not formatted.	Format or replace the card. <ul style="list-style-type: none"> <li>• Select [POWER OFF] and press .</li> <li>• Insert a new card.</li> <li>• Select [FORMAT] ► [YES] and press .</li> </ul> All data on the card is erased.
	There is an error in the internal memory.	Select [MEMORY FORMAT] ► [YES] and press  . All data in the internal memory is erased.
 NO CONNECTION	The camera is not connected to the printer correctly.	Disconnect the camera and connect it again correctly.
 NO PAPER	There is no paper in the printer.	Load some paper in the printer.
 NO INK	The printer has run out of ink.	Replace the ink cartridge in the printer.
 JAMMED	The paper is jammed.	Remove the jammed paper.
SETTINGS CHANGED	The printer's paper tray has been removed or the printer has been operated while changing settings on the camera.	Do not operate the printer while changing settings on the camera.
 PRINT ERROR	There is a problem with the printer and/or camera.	Turn off the camera and printer. Check the printer and remedy any problems before turning the power on again.
 CANNOT PRINT	Pictures recorded on other cameras may not be printed on this camera.	Use a computer to print.

## Functions that can be assigned to My Mode and custom button

Function	MY MODE SETUP	CUSTOM BUTTON	Ref. Page
<b>P/A/S/M/SCN</b>	✓	—	P. 12
	✓	—	P. 16
FNo.	✓	—	P. 13
Shutter speed	✓	—	P. 13
FLASH MODE	✓	—	P. 17
	✓	—	P. 16
	✓	—	P. 16
MONITOR(LOI)* <sup>1</sup>	✓	—	P. 10
ZOOM* <sup>2</sup>	✓	—	P. 11
DIS MODE	✓	✓ (default)	P. 25
AE LOCK	—	✓	P. 12
AF LOCK	—	✓	P. 12
IMAGE QUALITY	✓	✓	P. 20
WB	✓	—	P. 22
ISO	✓	—	P. 23
DRIVE	✓	—	P. 23
METERING	✓	—	P. 24
FINE ZOOM	✓	✓	P. 24
DIGITAL ZOOM	✓	✓	P. 24

Function	MY MODE SETUP	CUSTOM BUTTON	Ref. Page
AF MODE	✓	✓	P. 24
FOCUS MODE	✓	✓	P. 25
FULLTIME AF	✓	✓	P. 25
AF PREDICT	✓	✓	P. 25
	✓	—	P. 26
	✓	✓	P. 26
	✓	✓	P. 26
	✓	✓	P. 26
PANORAMA	✓	—	P. 27
	✓	—	P. 27
SHARPNESS	✓	—	P. 27
CONTRAST	✓	—	P. 28
SATURATION	✓	—	P. 28
NOISE REDUCT.	✓	✓	P. 28
TIMELAPSE	✓	—	P. 28
INFO	✓	—	—
FRAME ASSIST	✓	—	P. 44
	✓	—	P. 44

\*1 Select and set either the monitor or the viewfinder to light when the camera is turned on.

\*2 For [ZOOM], select from 38 mm, 50 mm, 100 mm, 200 mm or 380 mm (these numbers are based on the focal length of a 35 mm camera).

## Functions available in shooting modes and scenes

Some functions cannot be set in certain shooting modes. For more details, refer to the table below. In mode, available functions vary depending on the modes set in the [MY MODE SETUP] menu.

In **SCN** mode, in order to produce specialized effects, some scenes limit control of certain functions. Those functions are indicated with an . For details, refer to "Functions with restrictions in shooting scenes" (P. 75).



## ● Modes and shooting functions

Function		Shooting mode						
		AUTO	P	A	S	M	SCN	
Flash	AUTO		✓		—			—
			✓		—			—
				✓				—
				✓				—
			✓		—			—
				✓				—
		—		✓		—	✓	
FNo.		—		✓	—	✓		—
Shutter speed			—		✓			—
				✓				✓
				✓				✓
					✓			
INFO				✓				—
Optical zoom				✓				✓
DIS MODE		✓			—		✓	—
DIS MOVIE MODE					—			✓
AE lock		—			✓			—
AF lock		—			✓			—
IMAGE QUALITY		✓ <sup>+1</sup>			✓			✓
WB		—				✓		
ISO		—	✓		✓ <sup>+2</sup>		✓	—
DRIVE		—		✓		✓ <sup>+3</sup>		—
METERING		—				✓		
FINE ZOOM		—			✓			—
DIGITAL ZOOM		—			✓			✓
AF MODE		—			✓			—
FOCUS MODE		—			✓			—
FULLTIME AF		—			✓			✓
AF PREDICT		—			✓			—
		—			✓			—
		—			✓			—
		—			✓			—
(still pictures)		—			✓			—
PANORAMA		—	✓		—			—
		—				✓		
SHARPNESS		—				✓		
CONTRAST		—				✓		
SATURATION		—				✓		

Function	Shooting mode							
	AUTO	P	A	S	M	SCN		
NOISE REDUCT.	—			✓				—
TIMELAPSE	—			✓				—
(movies)				—				✓
MEMORY FORMAT (FORMAT)					✓			
BACKUP					✓			
					✓			
PW ON SETUP					✓			
PW OFF SETUP					✓			
BEEP					✓			
					✓			
SHUTTER SOUND					✓			
VOLUME					✓			
REC VIEW					✓			
FILE NAME					✓			
PIXEL MAPPING					✓			
					✓			
					✓			
DUALTIME					✓			
ALARM CLOCK					✓			
VIDEO OUT					✓			
FRAME ASSIST				✓				—
				✓				—
MY MODE SETUP	—				✓			—
m/ft					✓			
AF ILLUMINAT.			✓					✓
CUSTOM BUTTON	—				✓			—

\*1 [RAW] is not available.

\*2 [AUTO] is not available.

\*3 [BKT] is not available.

## ● Functions with restrictions in shooting scenes

Function	Scene												
FLASH MODE		✓	—	✓	—	—	—	✓	—	—	—	✓ <sup>*1</sup>	
		✓	—	✓	—	—	—	✓	—	—	✓ <sup>*2</sup>	✓	
		✓	—	✓	—	—	—	✓	—	—	—	✓	
Optical zoom		✓	—	—	—	—	—	—	—	✓	—	—	
IMAGE QUALITY		—	—	—	—	—	—	—	—	—	—	— <sup>*4</sup>	✓ <sup>*3</sup>
DRIVE		✓	—	✓	—	—	—	✓	—	—	—	—	
FINE ZOOM		—	✓	—	—	—	—	—	✓	—	—	—	
DIGITAL ZOOM		—	✓	—	—	—	—	—	✓	—	—	—	
AF MODE		—	—	✓	—	—	—	—	—	—	✓	—	
FOCUS MODE		—	—	✓	—	—	—	—	—	✓	—	—	
FULLTIME AF		—	—	✓	—	—	—	—	—	—	✓	—	
AF PREDICT		—	—	✓	—	—	—	—	—	—	✓	—	
		✓	—	✓	—	—	—	✓	—	—	—	✓	
		✓	—	✓	—	—	—	✓	—	—	—	✓	
		✓	—	✓	—	—	—	✓	—	—	—	✓	
(still pictures)		—	—	—	—	—	—	—	—	—	—	—	✓
PANORAMA		—	—	—	—	—	—	—	—	—	—	—	✓
NOISE REDUCT.		—	✓ <sup>*5</sup>	—	—	—	—	✓ <sup>*5</sup>	—	—	—	—	—
TIMELAPSE		—	—	—	—	—	—	—	—	—	—	—	✓
AF ILLUMINAT.		—	—	—	—	—	—	—	—	—	—	—	✓

\*1 [] or [] cannot be selected.

\*2 This is fixed at [].

\*3 [RAW] cannot be selected.

\*4 [IMAGE QUALITY] is fixed at [640 x 480].

\*5 This is fixed at [ON].

## Camera care

### Cleaning the camera

#### Exterior:

- Wipe gently with a soft cloth. If the camera is very dirty, soak the cloth in mild soapy water and wring well. Wipe the camera with the damp cloth and then dry it with a dry cloth. If you have used the camera at the beach, use a cloth soaked in clean water and wrung well.

#### Monitor and viewfinder:

- Wipe gently with a soft cloth.

#### Lens:

- Blow dust off the lens with a commercial blower, then wipe gently with a lens cleaner.

#### Battery/Charger:

- Wipe gently with a soft, dry cloth.



#### Note

- Do not use strong solvents such as benzene or alcohol, or chemically treated cloth.
- Mold may form on the lens surface if the lens is left dirty.

### Storage

- When storing the camera for extended periods, remove the battery, AC adapter and card, and keep in a cool, dry place that is well ventilated.
- Periodically insert the battery and test the camera functions.



#### Note

- Avoid leaving the camera in places where chemical products are handled since this may result in corrosion.

## Batteries

- The following batteries can be used with this camera. Choose the power source best suited to the situation.

#### AA alkaline batteries

The number of pictures that you can take may vary considerably depending on the battery manufacturer and shooting conditions.

#### AA NiMH batteries (rechargeable batteries)

Olympus NiMH batteries are rechargeable and economical. For details, refer to the instruction manual for your charger.

- **Lithium battery pack (CR-V3) and manganese (zinc-carbon) batteries cannot be used.**
  - Power consumption by the camera varies depending on which functions are used.
  - During the conditions described below, power is consumed continuously and the batteries become exhausted quickly.
    - The zoom is used repeatedly.
    - The shutter button is pressed halfway repeatedly in shooting mode, activating the auto focus.
    - Set [FULLTIME AF] to [ON].
    - A picture is displayed on the monitor for an extended period of time.
    - The camera is connected to a computer or printer.
  - Battery life varies depending on the type of battery, manufacturer, shooting conditions, etc.
- Similarly, the camera may turn off without displaying the battery level warning or may display the battery level warning more quickly.

## Useful use of the accessories

### The card

Pictures can be recorded on the optional card.

The internal memory and card are the camera's media for recording pictures, similar to film in a film camera.

Pictures recorded to the internal memory or card can be easily erased on the camera or processed using a computer.

Unlike portable storage media, the internal memory cannot be removed or exchanged.

The number of recordable pictures can be increased by using a card with a larger capacity.

#### ① Index area

You can use this space to write the contents of the card.

#### ② Contact area

The part where the data transferred from the camera enters the card.

#### Compatible cards

xD-Picture Card (16MB – 1GB)

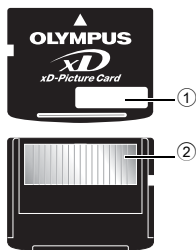

## Using the internal memory or card

You can confirm on the monitor whether the internal memory or card is being used during shooting and playback operations.

### Shooting mode



### Playback mode



Memory indicator  
[IN]: When internal memory is used.  
[xD]: When the card is used.

## Inserting and removing the card

- 1 Turn off the camera.
- 2 Open the card cover.

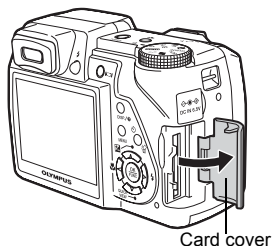

### Inserting the card

- 3 Orient the card as shown, and insert it into the card slot as shown in the illustration.

- Insert the card straight in.
- Insert the card until it clicks into place.

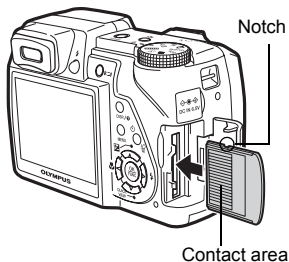

### Removing the card

- 3 Push the card all the way in and release slowly.

- The card protrudes slightly and stops.
- Grasp the card and remove

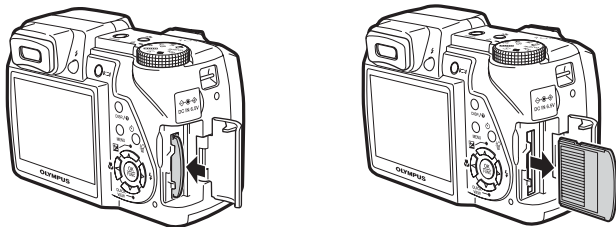

#### 4 Close the card cover.

#### **!** Note

- The card access lamp blinks while the camera is reading the images. Reading of images may take some time. Do not open the battery compartment cover/card cover while the card access lamp is blinking. Doing so may damage the data in the internal memory or the card and render the internal memory or card unusable.

### AC adapter

An AC adapter is useful for time-consuming tasks such as image downloads to a computer or when running a slideshow for a long period of time.  
Do not use any other AC adapter with this camera.

#### **!** Note

- Do not remove or load the battery or connect or disconnect the AC adapter or the multi-adapter while the camera is turned on. Doing so could affect the camera's internal settings or functions.
- The AC adapter can be used within the range of AC 100 V to AC 240 V (50/60 Hz).
- When using abroad, you may need a plug adapter to convert the plug to match the AC wall outlet. For details, ask at your local electrical shop or travel agent.
- Do not use travel voltage converters as they could damage your AC adapter.
- The camera is not water resistant during AC adapter use.
- Be sure to read the instruction manual for the AC adapter.

## SAFETY PRECAUTIONS

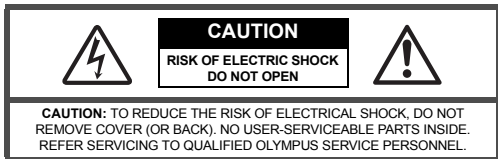

An exclamation mark enclosed in a triangle alerts you to important operating and maintenance instructions in the documentation provided with the product.



DANGER

If the product is used without observing the information given under this symbol, serious injury or death may result.



WARNINGS

If the product is used without observing the information given under this symbol, injury or death may result.



CAUTION

If the product is used without observing the information given under this symbol, minor personal injury, damage to the equipment, or loss of valuable data may result.

### WARNING!

**TO AVOID THE RISK OF FIRE OR ELECTRICAL SHOCK, NEVER DISASSEMBLE, EXPOSE THIS PRODUCT TO WATER OR OPERATE IN A HIGH HUMIDITY ENVIRONMENT.**

## General Precautions

**Read All Instructions** — Before you use the product, read all operating instructions. Save all manuals and documentation for future reference.

**Cleaning** — Always unplug this product from the wall outlet before cleaning. Use only a damp cloth for cleaning. Never use any type of liquid or aerosol cleaner, or any type of organic solvent to clean this product.

**Attachments** — For your safety, and to avoid damaging the product, use only accessories recommended by Olympus.

**Water and Moisture** — For precautions on products with weatherproof designs, read the weatherproofing sections.

**Location** — To avoid damage to the product, mount the product securely on a stable tripod, stand, or bracket.

**Power Source** — Connect this product only to the power source described on the product label.

**Lightning** — If a lightning storm occurs while using an AC adapter, remove it from the wall outlet immediately.

**Foreign Objects** — To avoid personal injury, never insert a metal object into the product.

**Heat** — Never use or store this product near any heat source such as a radiator, heat register, stove, or any type of equipment or appliance that generates heat, including stereo amplifiers.

## Handling the Camera



### WARNING

- Do not use the camera near flammable or explosive gases.
- Do not use the flash on people (infants, small children, etc.) at close range.
  - You must be at least 1 m (3 ft.) away from the faces of your subjects. Firing the flash too close to the subject's eyes could cause a momentary loss of vision.



- **Keep young children and infants away from the camera.**
  - Always use and store the camera out of the reach of young children and infants to prevent the following dangerous situations which could cause serious injury:
    - Becoming entangled in the camera strap, causing strangulation.
    - Accidentally swallowing the battery, cards or other small parts.
    - Accidentally firing the flash into their own eyes or those of another child.
    - Accidentally being injured by the moving parts of the camera.
- **Do not look at the sun or strong lights with the camera.**
- **Do not use or store the camera in dusty or humid places.**
- **Do not cover the flash with a hand while firing.**

### CAUTION

- **Stop using the camera immediately if you notice any unusual odors, noise, or smoke around it.**
  - Never remove the batteries with bare hands, which may cause a fire or burn your hands.
- **Never hold or operate the camera with wet hands.**
- **Do not leave the camera in places where it may be subject to extremely high temperatures.**
  - Doing so may cause parts to deteriorate and, in some circumstances, cause the camera to catch fire. Do not use the charger or AC adapter if it is covered (such as a blanket). This could cause overheating, resulting in fire.
- **Handle the camera with care to avoid getting a low-temperature burn.**
  - When the camera contains metal parts, overheating can result in a low-temperature burn. Pay attention to the following:
    - When used for a long period, the camera will get hot. If you hold on to the camera in this state, a low-temperature burn may be caused.
    - In places subject to extremely cold temperatures, the temperature of the camera's body may be lower than the environmental temperature. If possible, wear gloves when handling the camera in cold temperatures.
- **Be careful with the strap.**
  - Be careful with the strap when you carry the camera. It could easily catch on stray objects - and cause serious damage.

## Battery Handling Precautions

**Follow these important guidelines to prevent batteries from leaking, overheating, burning, exploding, or causing electrical shocks or burns.**

### DANGER

- Use only the Olympus brand NiMH batteries and proper fitting charger.
- Never heat or incinerate batteries.
- Take precautions when carrying or storing batteries to prevent them from coming into contact with any metal objects such as jewelry, pins, fasteners, etc.
- Never store batteries where they will be exposed to direct sunlight, or subjected to high temperatures in a hot vehicle, near a heat source, etc.
- To prevent causing battery leaks or damaging their terminals, carefully follow all instructions regarding the use of batteries. Never attempt to disassemble a battery or modify it in any way, solder, etc.
- If battery fluid gets into your eyes, flush your eyes immediately with clear, cold running water and seek medical attention immediately.
- Always store batteries out of the reach of small children. If a child accidentally swallows a battery, seek medical attention immediately.

### WARNING

- Keep batteries dry at all times.
- To prevent batteries from leaking, overheating, or causing a fire or explosion, use only batteries recommended for use with this product.
- Never mix batteries (old and new batteries, charged and uncharged batteries, batteries of different manufacture or capacity, etc.).
- Never attempt to charge alkaline, lithium or CR-V3 lithium battery packs.
- Insert the battery carefully as described in the operating instructions.
- Do not use batteries if their body is not covered by the insulating sheet or if the sheet is torn, as this may cause fluid leaks, fire, or injury.

## CAUTION

- Do not remove batteries immediately after using the camera. Batteries may become hot during prolonged use.
- Always unload the battery from the camera before storing the camera for a long period.

### • The following AA (R6) batteries cannot be used.

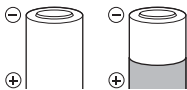

Batteries whose bodies are only partially or not at all covered by an insulating sheet.



Batteries whose  $\ominus$  terminals are raised, but not covered by an insulating sheet.

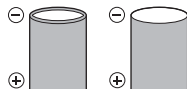

Batteries whose terminals are flat and not completely covered by an insulating sheet. (Such batteries cannot be used even if the  $\ominus$  terminals are partially covered.)

- If NiMH batteries are not charged within the specified time, stop charging them and do not use them.
- Do not use a battery if it is cracked or broken.
- If a battery leaks, becomes discolored or deformed, or becomes abnormal in any other way during operation, stop using the camera.
- If a battery leaks fluid onto your clothing or skin, remove the clothing and flush the affected area with clean, running cold water immediately. If the fluid burns your skin, seek medical attention immediately.
- Never subject batteries to strong shocks or continuous vibration.

## Caution for Usage Environment

- To protect the high-precision technology contained in this product, never leave the camera in the places listed below, no matter if in use or storage:
  - Places where temperatures and/or humidity are high or go through extreme changes. Direct sunlight, beaches, locked cars, or near other heat sources (stove, radiator, etc.) or humidifiers.
  - In sandy or dusty environments.
  - Near flammable items or explosives.
  - In wet places, such as bathrooms or in the rain. When using products with weatherproof designs, read their manuals as well.
  - In places prone to strong vibrations.
- Never drop the camera or subject it to severe shocks or vibrations.
- When mounted on a tripod, adjust the position of the camera with the tripod head. Do not twist the camera.
- Do not touch electric contacts on cameras.
- Do not leave the camera pointed directly at the sun. This may cause lens or shutter curtain damage, color failure, ghosting on the CCD, or may possibly cause fires.
- Do not push or pull severely on the lens.
- Before storing the camera for a long period, remove the batteries. Select a cool, dry location for storage to prevent condensation or mold from forming inside the camera. After storage, test the camera by turning it on and pressing the shutter button to make sure that it is operating normally.
- Always observe the operating environment restrictions described in the camera's manual.

## Battery Handling Precautions

- Olympus NiMH batteries (included in some areas) are intended for use only with Olympus digital cameras. Never use these batteries with any other device.
- Always charge NiMH batteries (included in some areas) before using them for the first time, or if they have not been used for a long period.
- Always charge sets of batteries (included in some areas) (2 or 4) together.
- Do not use alkaline batteries unless it is absolutely necessary. In some cases, alkaline batteries may have a shorter service life than NiMH. Alkaline battery performance is limited, especially at low temperatures. The use of NiMH batteries is recommended.
- AA manganese (Zinc-Carbon) batteries cannot be used with this camera.
- When operating the camera with battery power at low temperatures, try to keep the camera and spare batteries as warm as possible. Batteries which run down at low temperatures may be restored after they are warmed at room temperature.
- Recommended temperature ranges for NiMH batteries:  
Operation..... 0°C to 40°C (32°F to 104°F)  
Charge..... 0°C to 40°C (32°F to 104°F)  
Storage..... -20°C to 30°C (-4°F to 86°F)
- Using, charging, or storing the batteries outside these ranges could shorten battery life or affect battery performance. Always unload the batteries from the camera before storing the camera for a long period.
- Before using NiMH or NiCd batteries, always read the provided instructions.
- The number of pictures you can take may vary depending on the shooting conditions or batteries.
- Before going on a long trip, and especially before traveling abroad, purchase an ample supply of extra batteries. The recommended batteries may be difficult to obtain while traveling.
- Please recycle batteries to help save our planet's resources. When you throw away dead batteries, be sure to cover their terminals and always observe local laws and regulations.

## LCD Monitor

- Do not push the monitor forcibly; otherwise the image may become vague, resulting in a playback mode failure or damage to the monitor.
- A strip of light may appear on the top/bottom of the monitor, but this is not a malfunction.
- When a subject is viewed diagonally in the camera, the edges may appear zigzagged on the monitor. This is not a malfunction; it will be less noticeable in playback mode.
- In places subject to low temperatures, the LCD monitor may take a long time to turn on or its color may change temporarily. When using the camera in extremely cold places, it is a good idea to occasionally place it in a warm place. An LCD monitor exhibiting poor performance due to low temperatures will recover in normal temperatures.
- The LCD used for the monitor is made with high-precision technology. However, black spots or bright spots of light may appear constantly on the LCD Monitor. Due to its characteristics or the angle at which you are viewing the monitor, the spot may not be uniform in color and brightness. This is not a malfunction.

## Legal and Other Notices

- Olympus makes no representations or warranties regarding any damages, or benefit expected by using this unit lawfully, or any request from a third person, which are caused by the inappropriate use of this product.
- Olympus makes no representations or warranties regarding any damages or any benefit expected by using this unit lawfully which are caused by erasing picture data.

## Disclaimer of Warranty

- Olympus makes no representations or warranties, either expressed or implied, by or concerning any content of these written materials or software, and in no event shall be liable for any implied warranty of merchantability or fitness for any particular purpose or for any consequential, incidental or indirect damages (including but not limited to damages for loss of business profits, business interruption and loss of business information) arising from the use or inability to use these written materials or software or equipment. Some countries do not allow the exclusion or limitation of liability for consequential or incidental damages, so the above limitations may not apply to you.
- Olympus reserves all rights to this manual.

## Warning

Unauthorized photographing or use of copyrighted material may violate applicable copyright laws. Olympus assumes no responsibility for unauthorized photographing, use or other acts that infringe upon the rights of copyright owners.

## Copyright Notice

All rights reserved. No part of these written materials or this software may be reproduced or used in any form or by any means, electronic or mechanical, including photocopying and recording or the use of any type of information storage and retrieval system, without the prior written permission of Olympus. No liability is assumed with respect to the use of the information contained in these written materials or software, or for damages resulting from the use of the information contained therein. Olympus reserves the right to alter the features and contents of this publication or software without obligation or advance notice.

## FCC Notice

- Radio and Television Interference

Changes or modifications not expressly approved by the manufacturer may void the user's authority to operate this equipment. This equipment has been tested and found to comply with the limits for a Class B digital device, pursuant to Part 15 of the FCC Rules. These limits are designed to provide reasonable protection against harmful interference in a residential installation. This equipment generates, uses, and can radiate radio frequency energy and, if not installed and used in accordance with the instructions, may cause harmful interference to radio communications. However, there is no guarantee that interference will not occur in a particular installation. If this equipment does cause harmful interference to radio or television reception, which can be determined by turning the equipment off and on, the user is encouraged to try to correct the interference by one or more of the following measures:

- Adjust or relocate the receiving antenna.
- Increase the distance between the camera and receiver.
- Connect the equipment to an outlet on a circuit different from that to which the receiver is connected.
- Consult your dealer or an experienced radio/TV technician for help. Only the OLYMPUS-supplied USB cable should be used to connect the camera to USB-enabled personal computers (PC).

Any unauthorized changes or modifications to this equipment would void the user's authority to operate.

## For customers in North and South America

### For customers in USA

Declaration of Conformity

Model Number : SP-510UZ

Trade Name : OLYMPUS

Responsible Party : **OLYMPUS IMAGING AMERICA INC.**

Address : 3500 Corporate Parkway, P.O. Box 610, Center Valley,  
PA 18034-0610, U.S.A.

Telephone Number: 484-896-5000

Tested To Comply With FCC Standards  
FOR HOME OR OFFICE USE

This device complies with Part 15 of the FCC rules. Operation is subject to the following two conditions:

(1) This device may not cause harmful interference.

(2) This device must accept any interference received, including interference that may cause undesired operation.

### For customers in Canada

This Class B digital apparatus meets all requirements of the Canadian Interference-Causing Equipment Regulations.

## For customers in Europe



"CE" mark indicates that this product complies with the European requirements for safety, health, environment and customer protection. "CE" mark cameras are intended for sales in Europe.



This symbol [crossed-out wheeled bin WEEE Annex IV] indicates separate collection of waste electrical and electronic equipment in the EU countries. Please do not throw the equipment into the domestic refuse. Please use the return and collection systems available in your country for the disposal of this product.

### Provisions of warranty

1. If this product proves to be defective, although it has been used properly (in accordance with the written Handling Care and Operating instructions supplied with it), during a period of two years from the date of purchase from an authorized Olympus distributor within the business area of Olympus Imaging Europa GmbH as stipulated on the website: <http://www.olympus.com> this product will be repaired, or at Olympus's option replaced, free of charge. To claim under this warranty the customer must take the product and this Warranty Certificate before the end of the two year warranty period to the dealer where the product was purchased or any other Olympus service station within the business area of Olympus Imaging Europa GmbH as stipulated on the website: <http://www.olympus.com>. During the one year period of the World Wide Warranty the customer may turn the product in at any Olympus service station. Please notice that not in all countries such Olympus service station exists.
2. The customer shall transport the product to the dealer or Olympus authorized service station at his own risk and shall be responsible for any costs incurred in transporting the product.

3. This warranty does not cover the following and the customer will be required to pay repair charge, even for defects occurring within the warranty period referred to above.
  - (a) Any defect that occurs due to mishandling (such as an operation performed that is not mentioned in the Handling Care or other sections of the instructions, etc.)
  - (b) Any defect that occurs due to repair, modification, cleaning, etc. performed by anyone other than Olympus or an Olympus authorized service station.
  - (c) Any defect or damage that occurs due to transport, a fall, shock, etc. after purchase of the product.
  - (d) Any defect or damage that occurs due to fire, earthquake, flood damage, thunderbolt, other natural disasters, environmental pollution and irregular voltage sources.
  - (e) Any defect that occurs due to careless or improper storage (such as keeping the product under conditions of high temperature and humidity, near insect repellents such as naphthalene or harmful drugs, etc.), improper maintenance, etc.
  - (f) Any defect that occurs due to exhausted batteries, etc.
  - (g) Any defect that occurs due to sand, mud, etc. entering the inside of the product casing.
  - (h) When this Warranty Certificate is not returned with the product.
  - (i) When any alterations whatsoever are made to the Warranty Certificate regarding the year, month and date of purchase, the customer's name, the dealer's name, and the serial number.
  - (j) When proof of purchase is not presented with this Warranty Certificate.
4. This Warranty applies to the product only; the Warranty does not apply to any other accessory equipment, such as the case, strap, lens cap and batteries.
5. Olympus's sole liability under this warranty shall be limited to repairing or replacing the product. Any liability for indirect or consequential loss or damage of any kind incurred or suffered by the customer due to a defect of the product, and in particular any loss or damage caused to any lenses, films, other equipment or accessories used with the product or for any loss resulting from a delay in repair or loss of data, is excluded. Compelling regulations by law remain unaffected by this.

### Notes regarding warranty maintenance

1. This warranty will only be valid if the Warranty Certificate is duly completed by Olympus or an authorized dealer or other documents contain sufficient proof. Therefore, please make sure that your name, the name of the dealer, the serial number and the year, month and date of purchase are all completed or the original invoice or the sales receipt (indicating the dealer's name, the date of purchase and product type) is attached to this Warranty Certificate. Olympus reserves the right to refuse free-of-charge service if neither Warranty Certificate is completed nor the above document is attached or if the information contained in it is incomplete or illegible.
2. Since this Warranty Certificate will not be re-issued, keep it in a safe place.
  - \* Please refer to the list on the website: <http://www.olympus.com> for the authorized international Olympus service network.

## Trademarks

- IBM is a registered trademark of International Business Machines Corporation.
- Microsoft and Windows are registered trademarks of Microsoft Corporation.
- Macintosh is a trademark of Apple Computer Inc.
- xD-Picture Card™ is a trademark.
- All other company and product names are registered trademarks and/or trademarks of their respective owners.
- The standards for camera file systems referred to in this manual are the "Design Rule for Camera File System/DCF" standards stipulated by the Japan Electronics and Information Technology Industries Association (JEITA).

## SPECIFICATIONS

### ● Camera

Product type	: Digital camera (for shooting and displaying)
Recording system	: Digital recording, JPEG (in accordance with Design rule for Camera File system (DCF))
Still pictures	: Digital recording, JPEG (in accordance with Design rule for Camera File system (DCF))
Applicable standards	: Exif 2.2, Digital Print Order Format (DPOF), PRINT Image Matching III, PictBridge
Sound with still pictures	: Wave format
Movie	: QuickTime Motion JPEG
Memory	: Internal memory xD-Picture Card (16 MB to 1 GB)
No. of effective pixels	: 7,100,000 pixels
Image pickup device	: 1/2.5" CCD (primary color filter), 7,380,000 pixels (gross)
Lens	: Olympus lens 6.3 to 63.0 mm, f2.8 to 3.7 (equivalent to 38 to 380 mm on a 35 mm camera)
Photometric system	: Digital ESP metering, spot metering system
Shutter speed	: 15 to 1/1000 sec. (During bulb: Max. 8 minutes)
Aperture	: F2.8 to F8.0
Shooting range	: 0.07 m (2.88 in.) to ∞ (W) 1.2 m (4.0 ft.) to ∞ (T) (normal/macro mode) 0.03 m (1.19 in.) to ∞ (super macro mode)
Monitor	: 2.5" TFT color LCD display, 115,000 pixels
Flash charge time	: Approx. 6.5 sec. (for full flash discharge at room temperature using a new fully charged battery)
Outer connector	: DC-IN jack USB connector, A/V OUT jack (multi-connector)
Automatic calendar system	: 2000 up to 2099
Operating environment	
Temperature	: 0°C to 40°C (32°F to 104°F) (operation)/ -20°C to 60°C (-4°F to 140°F) (storage)
Humidity	: 30% to 90% (operation)/10% to 90% (storage)
Power supply	: AA alkaline / nickel hydride batteries (four) or Olympus AC adapter
Dimensions	: 105.5 mm (W) × 74.5 mm (H) × 70.0 mm (D) (4.25 × 3.00 × 2.88 in.) (excluding protrusions)
Weight	: 325 g (11 oz) without batteries and card

Design and specifications subject to change without notice.

# CAMERA DIAGRAM

## Camera

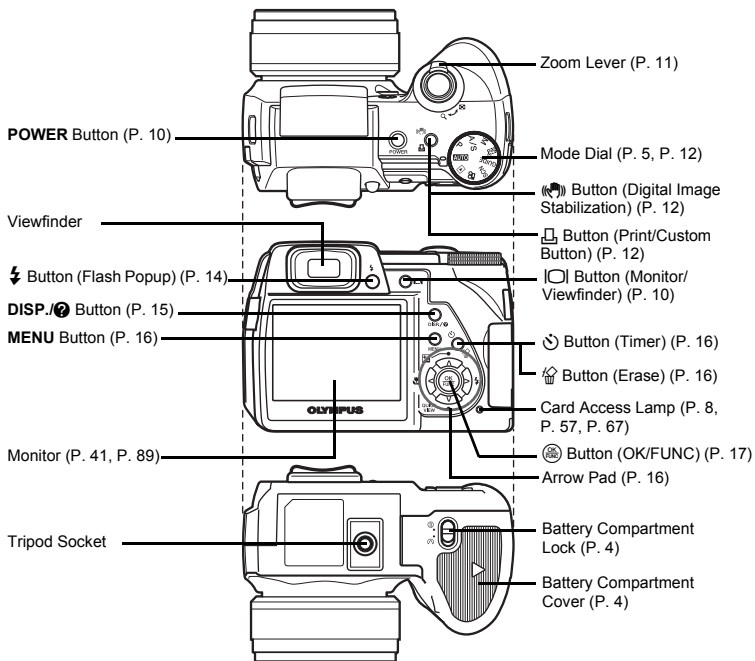
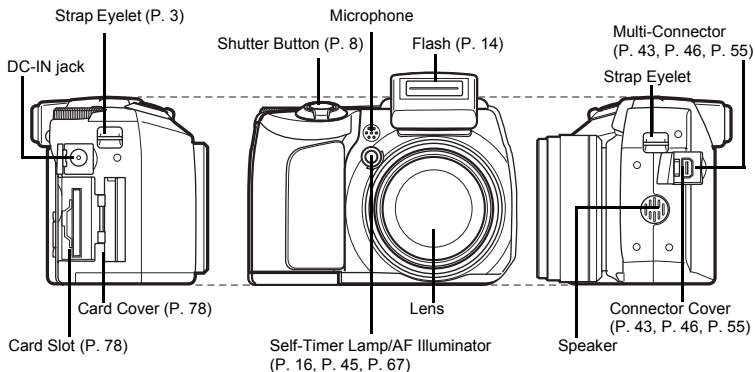



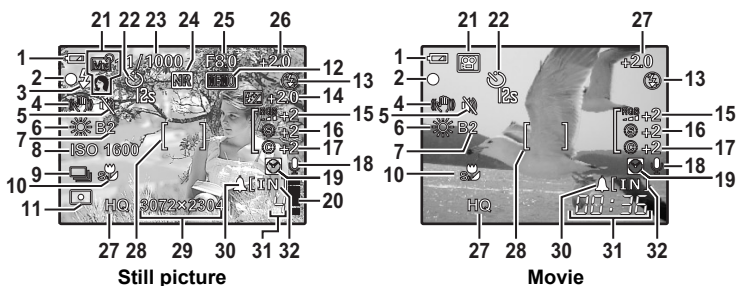

## Monitor Symbols & Icons

### ● Monitor – Shooting Mode



	Items	Indications	Ref. Page
1	Battery check	= full power,  = low power	P. 70
2	Green lamp	○ = Auto Focus Lock	P. 10, P. 67
3	Flash standby Camera movement warning / Flash charge	(Lit) (Blinks)	P. 62
4	Digital image stabilization		P. 25
5	Silent mode		P. 29
6	White balance	WB AUTO, , , , , ,	P. 22
7	White balance compensation	B1 – B7, R1 – R7	P. 27
8	ISO	ISO 100, ISO 800, ISO 2500, etc.	P. 23
9	Drive	, , ,	P. 23
10	Macro mode Super macro mode Manual focus	  	P. 16 P. 25
11	Spot metering		P. 24
12	AE lock AE memory	 	P. 12
13	Flash mode	, , , etc.	P. 17
14	Exposure compensation	-2.0 – +2.0	P. 26
15	Saturation	-5 – +5	P. 28
16	Contrast	-5 – +5	P. 28
17	Sharpness	-5 – +5	P. 27
18	Sound record		P. 26
19	Dual time		P. 42
20	Memory gauge	(Maximum reached)	P. 62
21	Shooting modes	<b>AUTO</b> , <b>P</b> , <b>A</b> , <b>S</b> , <b>M</b> , 1 – 4, 5, etc.	P. 5, P. 12, P. 21

	Items	Indications	Ref. Page
22	Self-timer		P. 16
23	Shutter speed	15" – 1/1000, BULB	P. 13
24	Noise reduction	<b>NR</b>	P. 28
25	Aperture	F2.8 – F8.0	P. 13
26	Exposure compensation	-2.0 – +2.0	P. 16
27	Image quality	RAW, SHQ, HQ, SQ1, SQ2	P. 20
28	AF target mark	[ ]	P. 8, P. 24
29	Image size	3072 x 2304, 2560 x 1920, 640 x 480, etc.	P. 20
30	Alarm		P. 42
31	Number of storable still pictures Remaining recording time	4 00:36	P. 66
32	Current memory	[IN]: (Recording pictures to the internal memory), [xD]: (Recording pictures to the card)	P. 78

## ● Monitor – Playback mode

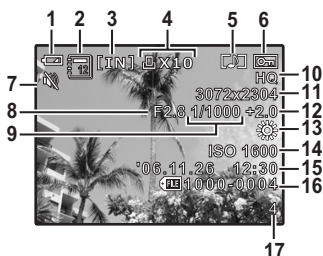

Still picture

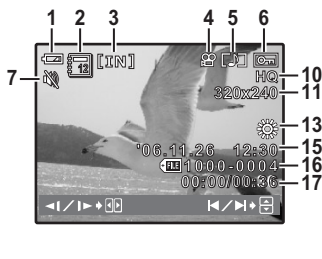

Movie

Items	Indications	Ref. Page
1 Battery check	= full power,  = low power	P. 70
2 Album		P. 31, P. 38
3 Current memory	[IN]: (Playing back pictures in the internal memory), [xD]: (Playing back pictures in the card)	P. 78
4 Print reservation/Number of prints Still picture	x 10	P. 49
4 Print reservation/Number of prints Movie		P. 31
5 Sound record		P. 36
6 Protect		P. 35
7 Silent mode		P. 29
8 Aperture	F2.8 – F8.0	P. 13
9 Shutter speed	15" – 1/1000, BULB	P. 13
10 Image quality	RAW, SHQ, HQ, SQ1, SQ2	P. 20
11 Image size	3072 x 2304, 2560 x 1920, 640 x 480, etc.	P. 20
12 Exposure compensation	-2.0 – +2.0	P. 16
13 White balance	WB AUTO,	P. 22
14 ISO	ISO 100, ISO 800, ISO 2500, etc.	P. 23
15 Date and time	'06.11.26 12:30	P. 6, P. 42
16 File number	100-0004	P. 41
17 Frame number	4	P. 41
17 Elapsed time/Total recording time	00:00 / 00:36	P. 31

# Index

button (exposure compensation) . . . . .	16
button (digital image stabilization/print) . . . . .	12
button (flash mode) . . . . .	17
button (flash pop-up) . . . . .	14
button (macro) . . . . .	16
button (monitor/viewfinder) . . . . .	10
button (OK/FUNC) . . . . .	17
<b>QUICK VIEW</b> button . . . . .	17
button (self-timer/erase) . . . . .	16, 37
3:2 . . . . .	20

## A

AC adapter . . . . .	79
AE lock  . . . . .	12
AE memory  . . . . .	12
AF ILLUMINAT. . . . .	45
AF MODE . . . . .	24
AF PREDICT  . . . . .	25
AF sequential shooting  . . . . .	23
AF target mark . . . . .	90
ALARM CLOCK . . . . .	42
ALBUM . . . . .	31
ALBUM ENTRY . . . . .	36
Album playback . . . . .	38
ALL ERASE  . . . . .	38
ALL INDEX . . . . .	48
ALL PRINT . . . . .	48
All-frame reservation  . . . . .	51
Aperture priority mode <b>A</b> . . . . .	5, 13, 17
Aperture value . . . . .	13
AREA . . . . .	24
Arrow pad . . . . .	16
AUCTION  . . . . .	21
AUTO (ISO) . . . . .	23
AUTO (shooting mode) <b>AUTO</b> . . . . .	5, 13
AUTO (white balane) . . . . .	22
Auto bracketing <b>BKT</b> . . . . .	23

Auto focus <b>AF</b> . . . . .	25
Auto-flash . . . . .	17
AV cable . . . . .	3, 43
AVAILABLE LIGHT  . . . . .	21

## B





BACKUP . . . . .	40
Batteries . . . . .	76
BEACH  . . . . .	21
BEEP . . . . .	40
BEHIND GLASS  . . . . .	21
BLACK & WHITE . . . . .	32
BRIGHTNESS . . . . .	34

## C

CALENDAR (edit) . . . . .	33
CALENDAR (playback) . . . . .	31
CAMERA MENU . . . . .	19, 22
CANDLE  . . . . .	21
CAPTURE . . . . .	34
Card . . . . .	77
Card access lamp . . . . .	8, 57, 67
Card cover . . . . .	78
Center-weighted metering  . . . . .	24
CLOSE ALBUM . . . . .	39
Close-up playback  . . . . .	11
Cloudy day  . . . . .	22
Compression . . . . .	20
Connector cover . . . . .	43, 46, 55
CONTRAST  . . . . .	28
Cropping  . . . . .	32
CUISINE  . . . . .	21
CURRENT (MY MODE SETUP) . . . . .	44
CUSTOM (MY MODE SETUP) . . . . .	44
CUSTOM BUTTON . . . . .	45, 72, 88
CUSTOM PRINT . . . . .	47

## D











Date and time  . . . . .	6, 42
--------------------------	-------

DIGITAL ZOOM	24
DIRECT (Histogram)	44
Direct printing	46
DIS MODE 	12, 25
DIS MOVIE MODE 	12, 29
<b>DISP./?</b> button	15
DOCUMENTS 	21
DPOF	49
DRIVE	23
DUALTIME 	42

## E

EASY PRINT	46
EDIT	34
ERASE	37
Error messages	70
Exposure	16
Exposure compensation 	16



## F

FILE NAME	41, 49
Fill-in flash 	17
FINE ZOOM	24
FIREWORKS 	21
Flash intensity control 	26
Flash mode 	17
Flash off 	17
FLASH 	26
Flash	17
Fluorescent lamp 1/2/3 	22
Focus	8, 25, 64
Focus lock	10
FOCUS MODE	25
FORMAT	39
FRAME	33
FRAME ASSIST  	15, 44
Front curtain  <b>SYNC1</b>	26
FULLTIME AF	25



## G

Green lamp	8, 10
<b>GUIDE</b>	5, 14

## H

High speed sequential shooting 	23
Histogram 	15, 44, 69
HQ	20, 21, 66



## I

iESP	24
IMAGE QUALITY	20
Image size	20
IN	78
IN  FLASH	26
INDEX	34
Index display	11
INDEX PLAY 	35
INDOOR 	21
Information displays <b>DISP./?</b>	15
Internal memory	78
ISO	23

## J





JPEG	20
------	----

## L



LABEL	33
LABEL IMAGE	39
LANDSCAPE 	21
LANDSCAPE+PORTRAIT 	21
LAYOUT	33
LIGHTING FIX	34

## M

m/ft	44
Macro mode 	16
Manual focus <b>MF</b>	25
Manual mode <b>M</b>	5, 13
MEMORY FORMAT	39

Memory gauge	62
Memory indicator	78
MENU button	16, 18
Menu guide	15
METERING	24
Mode dial	5
Monitor	10, 41, 89
Monitor brightness adjustment 	41
MOVIE PLAY	31
Movie recording 	14
MULTI PRINT	48
Multi-connector	46, 55
MUSEUM 	21
MY MODE 	14
MY MODE SETUP  1/2/3/4	44

## N



NIGHT SCENE 	21
NIGHT+PORTRAIT 	21
Noise reduction <b>NR</b>	28
NTSC	43
Number of prints	49
Number of storable still pictures	8

## O







OLYMPUS Master	52
One-touch WB 	22
Optical zoom	24

## P



PAL	43
PANORAMA	27
PC	55
PictBridge	46
Picture rotation 	35
PIXEL MAPPING	41
PLAYBACK MENU	30, 35
Playback mode	10, 30
Playback on a TV	43















Playing time	31
PORTRAIT 	21
<b>POWER</b> button	5, 10
PRESET (WB)	22
Press completely	8
Press halfway	8
PRINT ORDER	35
Print settings 	49
Program mode <b>P</b>	5, 13
Protect 	35
PW OFF SETUP	40
PW ON SETUP	40

## R



RAW	20, 66
RAW DATA EDIT	32
Rear curtain  <b>SYNC2</b>	26
REC VIEW	41
Recording length of movies	66
Recording sound with movies 	29
Recording sound with still pictures 	26
Red-eye fill-in flash 	17
REDEYE FIX	32
Red-eye reduction flash 	17
Remaining recording time	14
RESET	21
RESET (MY MODE SETUP)	44
Resizing 	32

## S

SATURATION	28, 34
<b>SCN</b> (Scene)	21
SCREEN SETUP	40
SEL. ALBUM	38
SEL. IMAGE	33, 37, 38
Selecting a language 	40
SELF PORTRAIT 	21
Self-timer lamp	16
Self-timer 	16

SEPIA	32
Sequential shooting 	23
SET ALL	37
SET CALENDAR	37
SHARPNESS 	27
SHOOT & SELECT1/2 	21
Shooting guide ( <b>GUIDE</b> )	5, 14
Shooting mode	10, 19
SHQ	20, 66
Shutter button	8, 10
Shutter priority mode <b>S</b>	5, 13, 17
SHUTTER SOUND	40
Shutter speed	17
SILENT MODE 	29
Single-frame reservation 	50
Single-frame shooting 	23
SLAVE	26
Sleep mode	62
SLIDESHOW 	30
SNOOZE	43
SNOW 	21
SPORT 	21
SPOT (AF MODE)	24
Spot metering 	24
SQ1	20, 66
SQ2	20, 66
STANDARD	46
Sunny day 	22
SUNSET 	21
Super macro mode 	16
SYNCRO 	26

## T

TIMELAPSE 	28
Top menu	18
Total recording time	31
Tungsten light 	22

## U



UNDO ALL	38
----------	----

UNDO ENTRY (ALBUM ENTRY) . .	38
USB cable	3, 46, 47, 52, 55
USB driver	53, 60

## V

VIDEO OUT	43
Viewfinder	10
VOLUME	40

## W

Warning sound 	40
WB	22
White balance compensation 	27

## X

xD	78
xD-Picture Card	77

## Z

Zoom	11
Zoom level	11

# OLYMPUS®

<http://www.olympus.com/>

## OLYMPUS IMAGING CORP.

Shinjuku Monolith, 3-1 Nishi-Shinjuku 2-chome, Shinjuku-ku, Tokyo, Japan

## OLYMPUS IMAGING AMERICA INC.

3500 Corporate Parkway, P.O. Box 610, Center Valley, PA 18034-0610, U.S.A. Tel. 484-896-5000

### Technical Support (USA)

24/7 online automated help: <http://www.olympusamerica.com/support>

Phone customer support: Tel. 1-888-553-4448 (Toll-free)

Our phone customer support is available from 8 am to 10 pm

(Monday to Friday) ET

E-Mail: [distec@olympus.com](mailto:distec@olympus.com)

Olympus software updates can be obtained at: <http://www.olympusamerica.com/digital>

## OLYMPUS IMAGING EUROPA GMBH

Premises: Wendenstrasse 14-18, 20097 Hamburg, Germany

Tel: +49 40-23 77 3-0 / Fax: +49 40-23 07 61

Goods delivery: Bredowstrasse 20, 22113 Hamburg, Germany

Letters: Postfach 10 49 08, 20034 Hamburg, Germany

### European Technical Customer Support:

Please visit our homepage <http://www.olympus-europa.com>

or call our TOLL FREE NUMBER\* : **00800 - 67 10 83 00**

for Austria, Belgium, Denmark, Finland, France, Germany, Italy, Luxemburg, Netherlands, Norway, Portugal, Spain, Sweden, Switzerland, United Kingdom

\* Please note some (mobile) phone services providers do not permit access or request an additional prefix to +800 numbers.

For all European Countries not listed and in case that you can't get connected

to the above mentioned number, please make use of the following

CHARGED NUMBERS: **+49 180 5 - 67 10 83** or **+49 40 - 237 73 899**

Our Technical Customer Support is available from 9 am to 6 pm MET (Monday to Friday)