

# JVC



LYT1989-007A-M

**EN**

## GUIDEBOOK

---

### HARD DISK CAMCORDER

**GZ-MG880** AG/AH/AS

**GZ-MG840** AG/AH/AS

**GZ-MG830** AH

**GZ-MG680** AA

**GZ-MG645** AG

**GZ-MG630** AA/AG/AH/AS

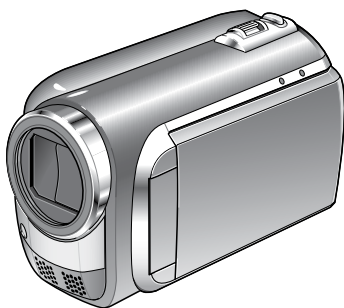

#### Dear Customers

Thank you for purchasing this camcorder. Before use, please read the safety information and precautions contained in pages 6 and 7 to ensure safe use of this product.

**HDD**

**micro  
SD  
HC**

**DOLBY**  
DIGITAL  
STEREO CREATOR

**HDMI**  
HIGH-DEFINITION MULTIMEDIA INTERFACE

**ENGLISH**

# Easy Start Guide

## Charge the battery before recording

Turn off the camcorder and attach the battery pack.

### Access lamp

blinks: Accessing files

Do not remove the AC adapter, the battery pack or the microSD card when the lamp is blinking.

### Power/charge lamp

blinks: Charging  
goes out: Charging finished

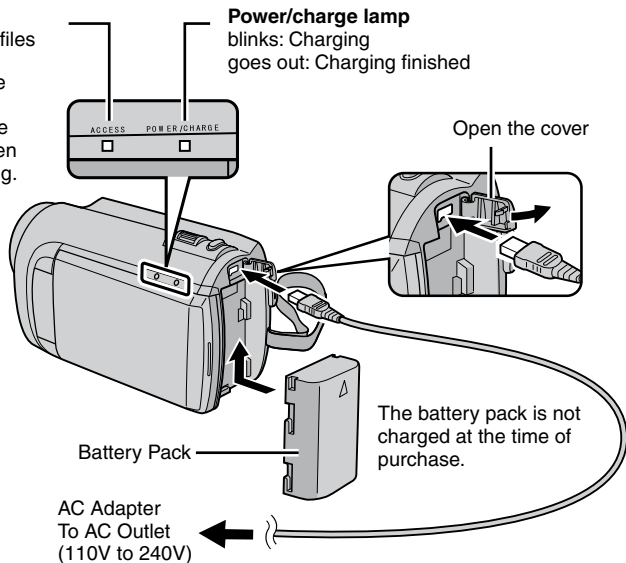

### CAUTION

- Be sure to use JVC battery packs. If you use any other battery packs besides JVC battery packs, safety and performance can not be guaranteed.

## Grip Adjustment

Adjust the strap and fasten.

- Fasten the strap when you grip the camcorder.
- When carrying the camcorder, please be careful not to drop it.

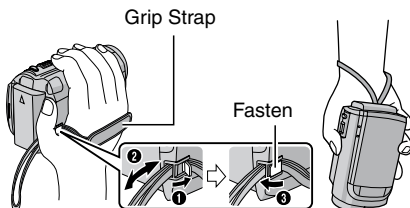

# Date/Time Setting

- 1** Open the LCD monitor to turn on the camcorder

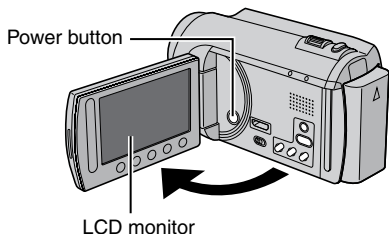

- 2** Select [YES] within 10 seconds

Slide your finger up and down on the sensor. Then touch OK.

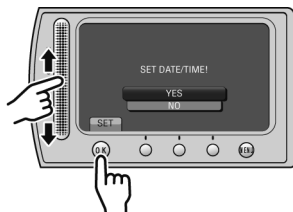

- When the message disappears, press the power button for at least 2 seconds to turn off the power, and then press it again for at least 2 seconds.
- Touch the sensors with your finger. The sensors do not function if you touch them with your finger nail or with gloves on.

- 3** Select [CLOCK SETTING]



- 4** Select the city closest to the area where you use the camcorder

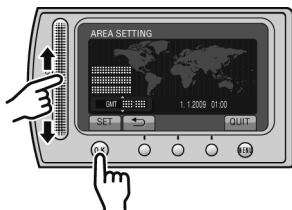

- 5** Select [ON] if daylight saving time is effective



- 6** Set the date and time

**Touch sensor:** Sets the date and time  
**→:** Moves the cursor to the right  
**OK:** Clock starts

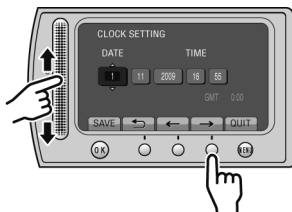

# Video recording

## CAUTION

Before recording an important scene, it is recommended to conduct a trial recording.

- 1 Slide the mode switch to select  (video) mode

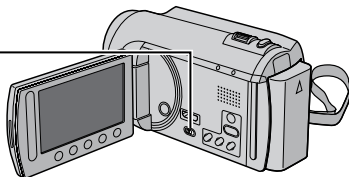
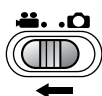

- 2 Select recording mode



The mode changes when you press the button.

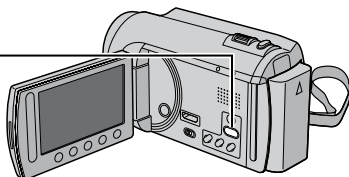

The auto recording indicator appears.

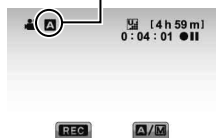

- 3 Start recording



Press the **START/STOP** button to start recording, and press it again to stop.



Remaining space on the hard disk

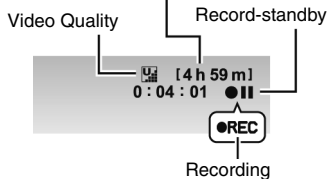

# Playing back

## 1 Select playback mode

PLAY / REC



The mode changes when you press the button.

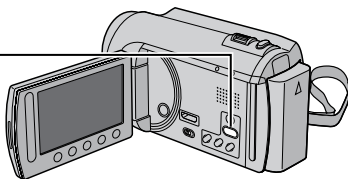

## 2 Select the desired file

Index screen



## 3 Select ► (Touch OK)

Playback screen



- To perform operations such as forward search or reverse search (☞ p. 24)
- To view files on TV (☞ p. 31)

### CAUTION

#### Do not forget to make copies after recording!

- To copy files onto DVD discs (☞ p. 44)
- To dub files to a VCR/DVD recorder (☞ p. 53)
- To play back a created disc (☞ p. 47)
- To edit files on your computer (☞ p. 48)

# Safety Precautions

**WARNING: TO PREVENT FIRE OR SHOCK HAZARD, DO NOT EXPOSE THIS UNIT TO RAIN OR MOISTURE.**

## CAUTIONS:

- If you notice smoke or a peculiar smell coming from the camcorder or AC Adapter, shut it down and unplug it immediately. Continue using the camcorder or AC Adapter under these conditions could lead to fire or electric shock. Contact your JVC dealer. Do not attempt to repair the malfunction yourself.
- To prevent shock, do not open the cabinet. No user serviceable parts inside. Refer servicing to qualified personnel.
- When you are not using the AC adapter for a long period of time, it is recommended that you disconnect the power cord from AC outlet.
- In certain areas, use the conversion plug depending on the type of your AC wall outlet..

## NOTES:

- The rating plate and safety caution are on the bottom and/or the back of the main unit.
- The serial number plate is on the battery pack mount.
- The rating information and safety caution of the AC adapter are on its upper and lower sides.

## WARNING:

The battery pack, the camcorder with battery installed, and the remote control with battery installed should not be exposed to excessive heat such as direct sunshine, fire or the like.

## CAUTION:

The mains plug shall remain readily operable.

## CAUTION:

To avoid electric shock or damage to the unit, first firmly insert the small end of the power cord into the AC Adapter until it is no longer wobbly, and then plug the larger end of the power cord into an AC outlet.

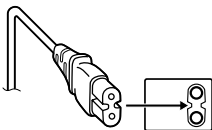

## Caution on Replaceable lithium battery

The battery used in this device may present a fire or chemical burn hazard if mistreated.

Do not recharge, disassemble, heat above 100°C or incinerate.

Replace battery with Panasonic, Sanyo, Sony or Maxell CR2025.

Danger of explosion or Risk of fire if the battery is incorrectly replaced.

- Dispose of used battery promptly.
- Keep away from children.
- Do not disassemble and do not dispose of in fire.

When the equipment is installed in a cabinet or on a shelf, make sure that it has sufficient space on all sides to allow for ventilation (10 cm or more on both sides, on top and at the rear).

Do not block the ventilation holes.

(If the ventilation holes are blocked by a newspaper, or cloth etc. the heat may not be able to get out.)

No naked flame sources, such as lighted candles, should be placed on the apparatus.

When discarding batteries, environmental problems must be considered and the local rules or laws governing the disposal of these batteries must be followed strictly.

The apparatus shall not be exposed to dripping or splashing.

Do not use this equipment in a bathroom or places with water.

Also do not place any containers filled with water or liquids (such as cosmetics or medicines, flower vases, potted plants, cups etc.) on top of this unit.

(If water or liquid is allowed to enter this equipment, fire or electric shock may be caused.)

Do not point the lens directly into the sun. This can cause eye injuries, as well as lead to the malfunctioning of internal circuitry. There is also a risk of fire or electric shock.

### CAUTION!

The following notes concern possible physical damage to the camcorder and to the user.

Carrying or holding the camcorder by the LCD monitor can result in dropping the unit, or in a malfunction.

Do not use a tripod on unsteady or unlevel surfaces. It could tip over, causing serious damage to the camcorder.

### CAUTION!

Connecting cables (Audio/Video, S-Video, etc.) to the camcorder and leaving it on top of the TV is not recommended, as tripping on the cables will cause the camcorder to fall, resulting in damage.



If this symbol is shown, it is only valid in the European Union.

### Remember that this camcorder is intended for private consumer use only.

Any commercial use without proper permission is prohibited. (Even if you record an event such as a show, performance or exhibition for personal enjoyment, it is strongly recommended that you obtain permission beforehand.)

### Trademarks

- Manufactured under license from Dolby Laboratories. Dolby and the double-D symbol are trademarks of Dolby Laboratories.
- HDMI is a trademark of HDMI Licensing, LLC. 
- Windows® is either registered trademark or trademark of Microsoft Corporation in the United States and/or other countries.
- Macintosh is a registered trademark of Apple Inc.
- iTunes is a trademark of Apple Inc., registered in the U.S. and other countries.
- YouTube and the YouTube logo are trademarks and/or registered trademarks of YouTube LLC.
- Other product and company names included in this instruction manual are trademarks and/or registered trademarks of their respective holders.

# Contents

## GETTING STARTED

<b>Accessories</b> .....	<b>10</b>
<b>[GZ-MG645]</b> Using the Everio Dock .....	10
Preparing the Remote Control .....	11
Attaching the Core Filter to the USB Cable ...	11
<b>Index</b> .....	<b>12</b>
<b>Indications on LCD Monitor</b> .....	<b>14</b>
<b>Necessary Settings before Use</b> .....	<b>16</b>
Charging the Battery Pack .....	16
Date/Time Setting .....	16
Language Setting .....	17
<b>Other Settings</b> .....	<b>18</b>
Grip Adjustment .....	18
Tripod Mounting .....	18
Using a microSD Card .....	19

## RECORDING/PLAYBACK

<b>Recording Files</b> .....	<b>20</b>
Video Recording .....	20
Still Image Recording .....	21
Zooming .....	22
LED Light .....	22
Checking the Remaining Battery Power .....	22
Checking the Remaining Space on the Recording Media .....	23
Registering Files to Events .....	23
<b>Playing Back Files</b> .....	<b>24</b>
Video Playback .....	24
Still Image Playback .....	25
File Search Function .....	26
Playing Back MPG Files .....	27
<b>Manual Recording</b> .....	<b>28</b>
Changing to Manual Recording Mode .....	28
Backlight Compensation .....	28
Manual Setting in Menu .....	28

## USING WITH TV

<b>Viewing Files on TV</b> .....	<b>31</b>
Connection with TV .....	31
Playback Operation .....	32
<b>Operating in Conjunction with TV via HDMI</b> .....	<b>33</b>

## EDITING

<b>Managing Files</b> .....	<b>34</b>
Capturing a Still Image from a Video .....	34
Deleting Files .....	34
Protecting Files .....	36
Viewing File Information .....	37
Changing the Event Registration .....	38
Trimming Files .....	39
<b>Playlists</b> .....	<b>40</b>
Creating Playlists .....	40
Playing Back Playlists .....	41
Other Operations of Playlists .....	42

## COPYING

<b>Copying Files</b> .....	<b>43</b>
Copying/Moving Files .....	43
Using a DVD Burner .....	44
Creating a DVD using a PC .....	48
Dubbing Files to a VCR/DVD Recorder .....	53
Dubbing Files from a VCR/DVD Player .....	54
<b>Using with a Portable Media Player</b> .....	<b>55</b>
Turning on the Export Mode .....	55
Changing the Export Setting .....	55
Transferring the Files to PC .....	56
<b>Uploading Files to Websites</b> .....	<b>57</b>
Turning on the Upload Mode .....	57
Upload Trimming .....	57
Uploading Files .....	58

## FURTHER INFORMATION

<b>Changing the Menu Settings</b> .....	<b>59</b>
<b>Troubleshooting</b> .....	<b>65</b>
<b>Warning Indications</b> .....	<b>69</b>
<b>Cleaning</b> .....	<b>71</b>
<b>Specifications</b> .....	<b>72</b>
<b>Cautions</b> .....	<b>74</b>
<b>Terms</b> .....	<b>80</b>



# How to use the Touch Sensor

After the menu is displayed on the LCD monitor:

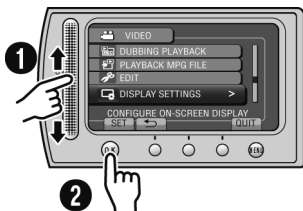

- 1 Slide your finger up and down on the sensor.
- 2 Select [SET]. (Touch OK.)

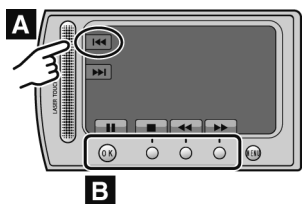

- A To select an on-screen button appearing on the left side, touch the portion of the sensor next to the on-screen button.
- B To select an on-screen button appearing at the bottom of the screen, touch the buttons underneath them.

## Read This First!

### Make a backup of important recorded data

It is recommended to copy your important recorded data to a DVD or other recording media for storage. JVC will not be responsible for any lost data.

### Make a trial recording

Before the actual recording of important data, make a trial recording and play back the recorded data to check that the video and sound have been recorded correctly.

### Reset the camcorder if it does not operate correctly

Close the LCD monitor and remove the power supply (battery pack or AC adapter) from the camcorder, then reattach it.

### Precautions on handling batteries

- Be sure to use the JVC BN-VF808U/VF815U/VF823U battery packs. This product includes patented and other proprietary technology and is made to be used with the JVC battery and not with other batteries. JVC cannot guarantee safety or performance of this product when it is operated by other batteries.
- If the camcorder is subjected to electrostatic discharge, turn off the power before using it again.

### If a malfunction occurs, stop using the camcorder immediately and consult your nearest JVC dealer

- Recorded data may be erased while the camcorder is being repaired or inspected. Back up all data before requesting repairs or inspections.

**Because camcorders may be used for demonstration in a shop, the demonstration mode is set to on by default**  
To deactivate the demonstration mode, set [DEMO MODE] to [OFF]. (☞ p. 61)

# Accessories

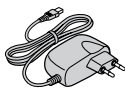

AP-V20E

or

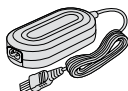

AP-V20M

**AC Adapter**

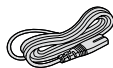

**Power Cord**  
(For AP-V20M only)

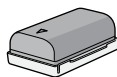

BN-VF808U

**Battery Pack**



**AV Cable**



**USB Cable**



RM-V751U

**Remote Control**



CR2025

**Lithium Battery**  
Pre-installed in the  
remote control.



**CD-ROM**



**Core Filter**



CU-VC8E

**GZ-MG645**  
**Everio Dock**

## NOTE

Make sure to use the provided cables for connections. Do not use any other cables.

## **GZ-MG645** Using the Everio Dock

You can connect cables to the connectors of the Everio dock. The connection is completed when you place the camcorder on the dock.

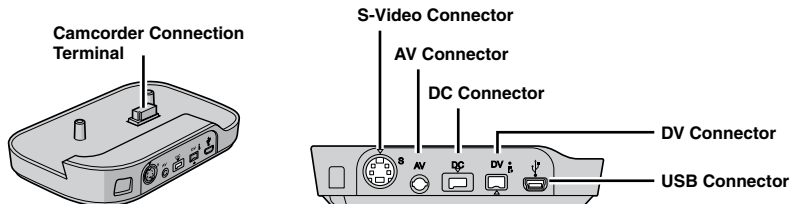

## NOTE

- Do not connect the USB cable to both the camcorder and the Everio dock to prevent a malfunction.
- The S-Video cable (optional) enables even higher playback quality on TV. (☞ p. 31) Be sure to use the YTU94146A S-Video cable.
- The DV cable (optional) enables even higher dubbing quality when dubbing files to a VCR/DVD recorder. (☞ p. 53) Be sure to use the JVC VC-VDV204U or VC-VDV206U DV cable. Operation using the DV cable is not guaranteed on all devices.
- When other devices such as a DVD burner are connected to the Everio dock, turn off these devices.

## Preparing the Remote Control

A battery is included inside the remote control at the time of purchase. Remove the insulation sheet before use.

### Beam Effective Area

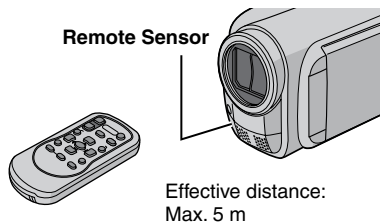

### NOTE

The transmitted beam may not be effective or may cause incorrect operation when the remote sensor is directly exposed to sunlight or powerful lighting.

### To Reinsert the Battery

Pull out the battery holder by pressing the lock tab.

### Lock Tab

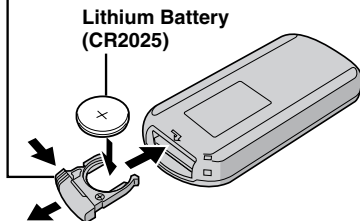

## Attaching the Core Filter to the USB Cable

The core filter reduces interference caused when connecting to other devices. Connect the end of the cable with the core filter to the camcorder.

### Release the stopper.

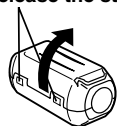

3 cm

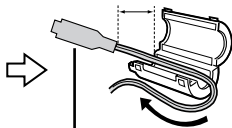

To be connected to  
the camcorder

### Wind once.



# Index

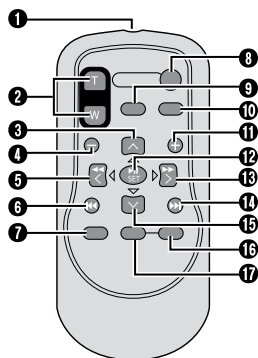
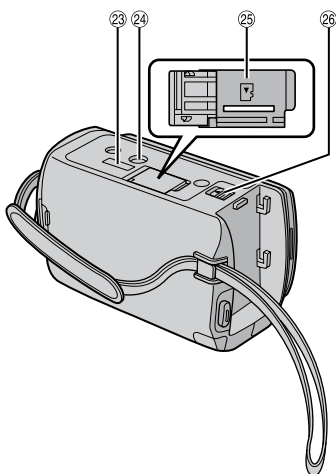
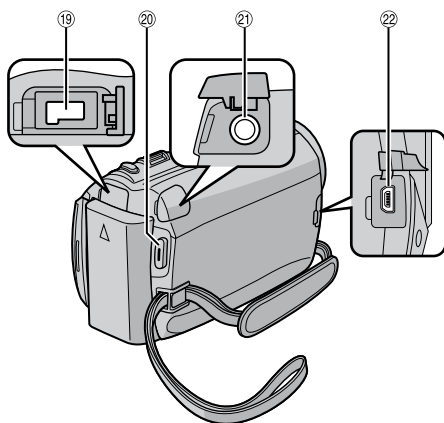
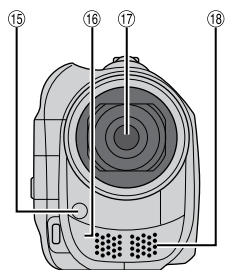
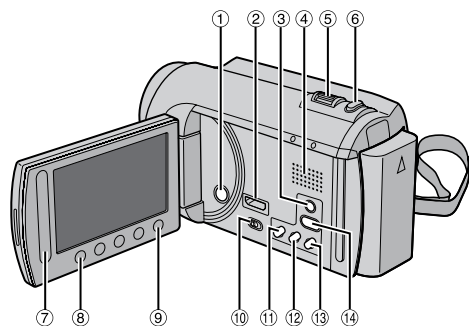

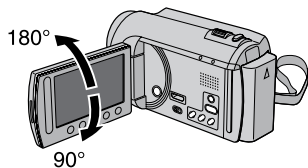

## NOTE

- Be careful not to cover 15, 16, 17, and 18 during shooting.
- The LCD monitor can rotate 270°.



## Camcorder

- ① Power Button
- ② **GZ-MG880** **GZ-MG840** **GZ-MG680** **GZ-MG645**  
HDMI Mini Connector (→ p. 31)
- ③ **DISPLAY** Button (→ p. 15)
- ④ Speaker
- ⑤ Zoom Lever (→ p. 22)  
Speaker Volume Control
- ⑥ **SNAPSHOT** Button (→ p. 21)
  
- ⑦ Touch Sensor
- ⑧ **OK** Button
- ⑨ **MENU** Button
  
- ⑩ Mode Switch [ 
- ⑪ **UPLOAD** Button (→ p. 57)  
**TITLE** Button (→ p. 41)
- ⑫ **EXPORT** Button (→ p. 55)
- ⑬ **DIRECT DVD** Button (→ p. 45)  
**INFO** Button (→ p. 22, 23, 37)
- ⑭ **PLAY/REC** Button (→ p. 20, 21, 24, 25)
  
- ⑮ LED Light (→ p. 22)
- ⑯ Remote Sensor
- ⑰ Lens
- ⑱ Stereo Microphone
  
- ⑲ DC Connector
- ⑳ **START/STOP** Button (→ p. 20)
- ㉑ AV Connector (→ p. 31, 53, 54)
- ㉒ USB Connector (→ p. 44, 49)
  
- ㉓ **GZ-MG645** Everio Dock Connector
- ㉔ Tripod Mounting Socket
- ㉕ microSD Card Slot
- ㉖ Battery Release Button

## Remote Control

- ① Infrared Beam Transmitting Window
- ② **ZOOM (T/W)** Buttons (Zoom in/Out)
- ③ Up Button
- ④ Skip Backward Button
  
- ⑤ Left Button
- ⑥ Back Button
- ⑦ **PLAYLIST** Button
- ⑧ **START/STOP** Button
  
- ⑨ **S.SHOT (SNAPSHOT)** Button
- ⑩ **INFO** Button
- ⑪ Skip Forward Button
- ⑫ **PLAY/PAUSE/SET** Button
  
- ⑬ Right Button
- ⑭ Next Button
- ⑮ Down Button
- ⑯ **INDEX** Button\*
- ⑰ **DISP** Button

\* Each time you press **INDEX**, the screen switches as shown below:

 mode:  
Index Screen ↔ Group Index Screen

 mode:  
Index Screen ↔ Date Index Screen

# Indications on LCD Monitor



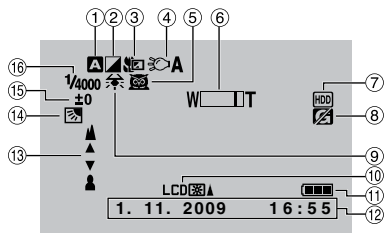



## During both Video and Still Image Recording

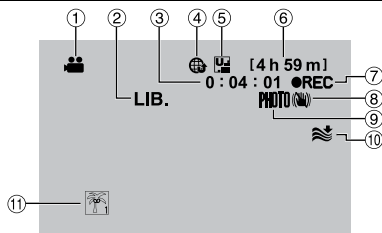

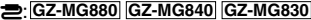
- ① Selected Recording Mode Indicator (↗ p. 28)  
**A**: Auto Mode  
**M**: Manual Mode
- ② Effect Mode Indicator (↗ p. 30)
- ③ Tele Macro Mode Indicator (↗ p. 30)
- ④ LED Light Indicator (↗ p. 22)
- ⑤ Scene Select Indicator (↗ p. 29)
- ⑥ Zoom Indicator (↗ p. 22)
- ⑦ Recording Medium Indicator (↗ p. 64)
- ⑧ Drop Detection Indicator (Appears when [DROPECTION] is set to [OFF].) (↗ p. 62)
- ⑨ White Balance Indicator (↗ p. 30)
- ⑩ Monitor Backlight Indicator (↗ p. 61)
- ⑪ Battery Indicator
- ⑫ Date/Time (↗ p. 16)
- ⑬ Manual Focus Adjustment Indicator (↗ p. 29)
- ⑭ Backlight Compensation Indicator (↗ p. 28)
- ⑮ Brightness Control Indicator (↗ p. 29)  
: Phometry Area Control Indicator (↗ p. 30)
- ⑯ Shutter Speed (↗ p. 29)

## During Video Recording Only



- ① Mode Indicator
- ② EXPORT Mode Indicator (↗ p. 55)
- ③ Counter
- ④ Upload Mode Indicator (↗ p. 57)  
: **GZ-MG880** **GZ-MG840** **GZ-MG830**  
: **GZ-MG680** **GZ-MG645** Analog Input Indicator (↗ p. 63)
- ⑤ Video Quality:  (ULTRA FINE),  (FINE),  (NORMAL),  (ECONOMY) (↗ p. 60)
- ⑥ Remaining Time
- ⑦ ● REC: (Appears during recording.)  
 ● : (Appears during record-standby mode.)
- ⑧ Digital Image Stabilizer (DIS) Indicator (Appears when [DIS] is set to [OFF].) (↗ p. 60)
- ⑨ Shooting Indicator (↗ p. 20)
- ⑩ Wind Cut Indicator (↗ p. 60)
- ⑪ Event Indicator (↗ p. 23)

## During Still Image Recording Only

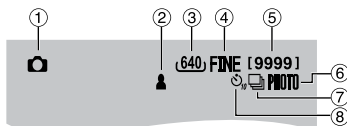

- ① Mode Indicator
- ② Focus Indicator (↗ p. 21)
- ③ **GZ-MG880** **GZ-MG840** **GZ-MG830**  
 Image Size (↗ p. 59)
- ④ Image Quality: FINE (fine) or STD (standard) (↗ p. 60)
- ⑤ Remaining Number of Shots
- ⑥ Shooting Indicator (↗ p. 21)
- ⑦ Shutter Mode Indicator (↗ p. 59)
- ⑧ Self-Timer Indicator (↗ p. 59)

## During Video Playback

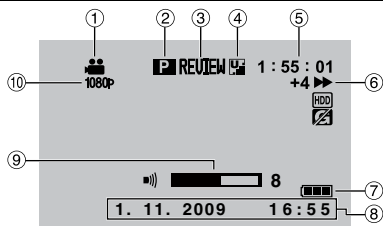

- ① Mode Indicator
- ② Playlist Playback Indicator (Appears when playing back a playlist.) (⇨ p. 41)
- ③ Quick Review Indicator (⇨ p. 20)
- ④ Video Quality: (ULTRA FINE), (FINE), (NORMAL), (ECONOMY) (⇨ p. 60)
- ⑤ Counter
- ⑥ Playback Mode
  - ▶ : Playback
  - ⏸ : Pause
  - ▶▶ : Forward Search
  - ◀◀ : Reverse Search
  - ▶▶▶ : Forward Slow-Motion
  - ◀◀◀ : Reverse Slow-Motion
 (The number on the left shows speed.)
- ⑦ Battery Indicator
- ⑧ Date/Time (⇨ p. 16)
- ⑨ Volume Level Indicator
- ⑩ **GZ-MG880** **GZ-MG840** **GZ-MG680** **GZ-MG645**  
Output with 1080p (⇨ p. 63)

## During Still Image Playback

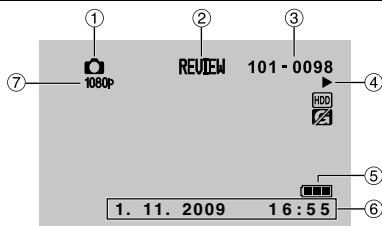

- ① Mode Indicator
- ② Quick Review Indicator (⇨ p. 21)
- ③ Folder/File Number
- ④ Slide Show Playback Indicator
- ⑤ Battery Indicator
- ⑥ Date/Time (⇨ p. 16)
- ⑦ **GZ-MG880** **GZ-MG840** **GZ-MG680** **GZ-MG645**  
Output with 1080p (⇨ p. 63)

### Switching indication modes on LCD monitor

Each time you touch **DISPLAY**, indications on LCD monitor switch as shown below:

In recording mode:

All indications/Indications for selected functions

In playback mode:

All indications/Only date and time/No indications

# Necessary Settings before Use

## Charging the Battery Pack

- 1 Close the LCD monitor to turn off the camcorder.
- 2 Attach the battery pack, then connect the AC adapter.

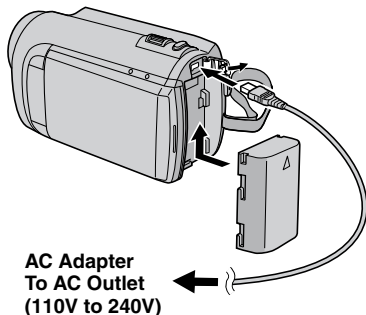

AC Adapter  
To AC Outlet  
(110V to 240V)

- **[GZ-MG645]** You can also connect the cables using the Everio dock.
- The power/charge lamp blinks to indicate charging has started.
- When the lamp goes out, charging is finished.

- **To check the remaining battery power**  
See page 22.

Battery pack	Charging time
BN-VF808U (Provided)	1 h 50 m
BN-VF815U	2 h 40 m
BN-VF823U	3 h 40 m

- **To detach the battery pack**

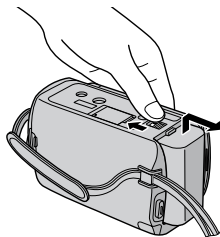

### NOTE

- You can also use the camcorder with just the AC adapter.
- The actual recording time may shorten depending on the recording environment, such as when recording scenes with fast moving subject.
- Please do not pull or bend the AC adapter plug and cable. This may damage the AC adapter.

## Date/Time Setting

- 1 Open the LCD monitor to turn on the camcorder.
- 2 Touch MENU.
- 3 Select [DISPLAY SETTINGS].



- 4 Select [CLOCK ADJUST].





## 5 Select [CLOCK SETTING].

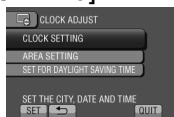

## 6 Select the city closest to the area where you use the camcorder.

Selected area is highlighted

Principal city of the selected area

Time difference to GMT



## 7 Select [ON] if daylight saving time is effective.

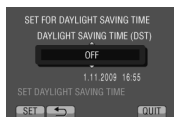

## 8 Set the date and time.

Change the setting by using the touch sensor and select [→] to set.



## 9 Select [SAVE].

To reset the setting, select [QUIT].

**Setting the clock to local time when traveling**

After performing steps 1-4 (p. 16)

## 5 Select [AREA SETTING].

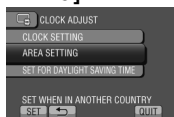

## 6 Select the city closest to the area you are traveling.

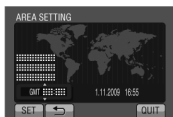

■ To return to the previous screen  
Select [←].

■ To quit the screen  
Select [QUIT].

## Language Setting

The language on the display can be changed.

1 Open the LCD monitor to turn on the camcorder.

2 Touch MENU.

3 Select [DISPLAY SETTINGS].



4 Select [LANGUAGE].

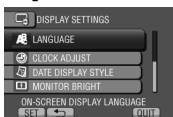

5 Select the desired language.

■ To return to the previous screen  
Select [←].

■ To quit the screen  
Select [QUIT].

# Other Settings

## Grip Adjustment

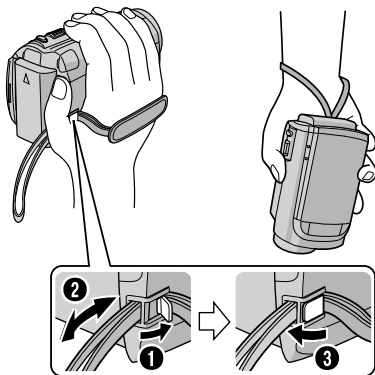

### NOTE

- Fasten the strap when you grip the camcorder.
- When carrying the camcorder, please be careful not to drop it.

## Tripod Mounting

Align the camcorder stud hole with the tripod stud, and the mounting socket with the screw, and then rotate the camcorder clockwise to mount it to the tripod.

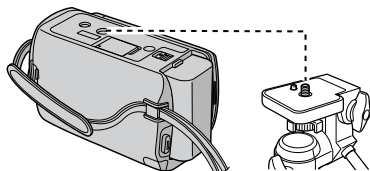

### NOTE

Do not use a tripod on unsteady or unlevel surfaces. It could tip over, causing serious damage to the camcorder.

## Using a microSD Card

The camcorder is programmed to record on the built-in hard disk when it is shipped from the factory. You can change the recording medium to microSD card.

- Operations are confirmed on the following microSD cards.
  - Panasonic
  - TOSHIBA
  - SanDisk
  - ATP

### Video recording:

Class 4 or higher compatible microSDHC card (4 GB to 8 GB)

### Still image recording:

microSD card (256 MB to 2 GB) or  
microSDHC card (4 GB to 8 GB)

- If other media are used, they may fail to record data correctly, or they may lose data that had already been recorded.
- MultiMediaCards are not supported.

## Insert a microSD card

### Preparation:

Close the LCD monitor to turn off the camcorder.

- 1 Open the microSD card cover.
- 2 Firmly insert the card with its clipped edge first.

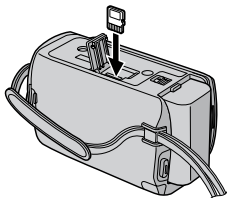

- 3 Close the microSD card cover.

## To remove a microSD card

Push the microSD card once.

After the card comes out a little, pull it out.

### NOTE

- Insert and remove the microSD card only while the power is turned off. Otherwise, data on the card may be corrupted.
- Do not touch the terminal on the reverse side of the label.

## Change the recording medium

Set [REC MEDIA FOR VIDEO] and [REC MEDIA FOR IMAGE] to [SD]. (p. 64)



## Format a microSD card when using it for the first time

Select [FORMAT SD CARD] to format the card. (p. 64)





# Recording Files

## Video Recording



**1** Slide the mode switch to select  (video) mode.

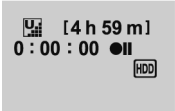

**2** Press **PLAY/REC** to select the recording mode.

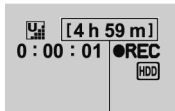

**3** Press **START/STOP** to start recording.



Approximate remaining time for recording

You can also start/stop recording by selecting [REC] on the LCD monitor. (On-screen recording control)

### ■ To stop recording

Press **START/STOP** again.

### ■ To view the last recorded scene

Select  while recording is paused.

Selecting  during playback deletes that scene.

### ■ To record a still image during video recording

Press **SNAPSHOT**.

### ■ To change the video quality

Change the settings in [VIDEO QUALITY].  
( p. 60)

### ■ To change the aspect ratio of the image (16:9/4:3)

Change the settings in [SELECT ASPECT RATIO]. ( p. 60)

### NOTE

- The video recording mode is automatically selected when you turn off the camcorder and then turn on again.
- If the camcorder is not operated for 5 minutes while the power is on, it turns itself off automatically to conserve power.
- Do not move or shake the camcorder suddenly during recording. If you do so, the driving sound (hum) of the hard disk may be recorded.

## Still Image Recording

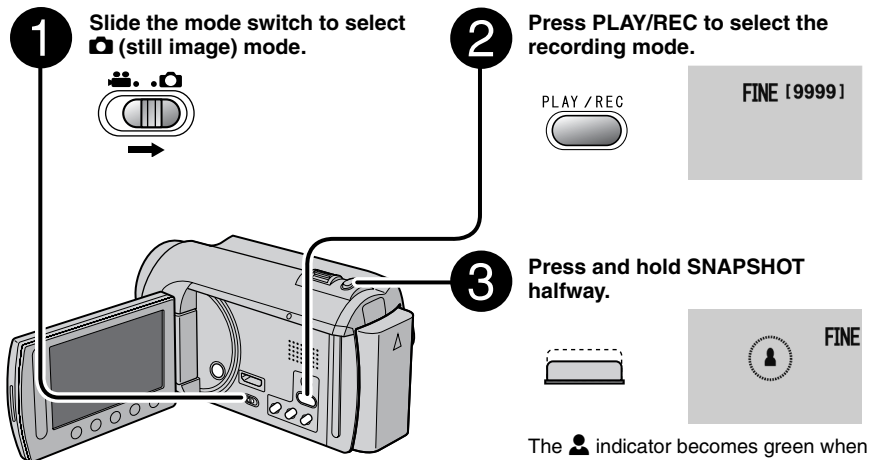

PLAY / REC

FINE [9999]

Press and hold **SNAPSHOT** halfway.



FINE

The indicator becomes green when the captured image is focused.

**4** Press **SNAPSHOT** fully to take a still image.



FINE [9999]

PHOTO

### ■ To view the last recorded image

Select after shooting.

Selecting during playback deletes that image.

### ■ To change the image quality

Change the settings in [IMAGE QUALITY].

( p. 60)

### ■ To record still images continuously

Set to [CONTINUOUS SHOOTING] in [SHUTTER MODE]. ( p. 59)

### ■ **GZ-MG880** **GZ-MG840** **GZ-MG830**

#### To change the image size

Change the settings in [IMAGE SIZE].

( p. 59)



### NOTE

- DIS (Digital Image Stabilizer) does not function during still image recording.
- If the camcorder is not operated for 5 minutes while the power is on, it turns itself off automatically to conserve power.

# Recording Files (Continued)

## Zooming

### Preparation:

- Select  or  mode.
- Select the recording mode.

### Zoom out



W: Wide angle

### Zoom in



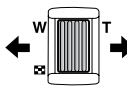

T: Telephoto



You can also zoom out/zoom in by selecting [W] or [T] on the LCD monitor. (On-screen zoom control)

### Zoom ratio (factory-preset)

Model	 mode	 mode
<b>GZ-MG880</b>	[76X/DIGITAL]	[27X/OPTICAL]
<b>GZ-MG840</b>		
<b>GZ-MG830</b>		
<b>GZ-MG680</b>	[70X/DIGITAL]	[35X/OPTICAL]
<b>GZ-MG645</b>		
<b>GZ-MG630</b>		

### ■ To change the maximum zoom ratio ( mode only)



Change the settings in [ZOOM]. (⇨ p. 60)

### NOTE

Macro shooting is possible as close as approx. 5 cm to the subject when the zoom lever is set all the way to W.

## LED Light

### Preparation:

- Select  or  mode.
- Select the recording mode.

### 1 Touch MENU.

### 2 Select [LIGHT].

### 3 Select the desired setting.

<b>ON</b>	The LED light remains on regardless of the surrounding conditions.
<b>AUTO</b>	The LED light turns on automatically when shooting in insufficient light conditions.
<b>OFF</b>	Deactivates this function.

## Checking the Remaining Battery Power

### mode:

Press **INFO** twice or **INFO** and then select .

### mode:

Press **INFO**.



### ■ To quit the screen

Select [QUIT] or press **INFO**.

### NOTE

The recordable time display should only be used as a guide. It is displayed in 10 minute units.

## Checking the Remaining Space on the Recording Media

### Preparation:

- Select **MODE** mode.
- Select the recording mode.

### Press INFO.



The maximum recording time is displayed for each video quality mode.

### ■ To change the video quality

- 1) Select the video quality.
- 2) Select [SET].

### ■ To quit the screen

Select [QUIT].

## Registering Files to Events

If you select an event to register the file to before starting recording, you can find the file easily at playback.

### Preparation:

- Select **MODE** mode.
- Select the recording mode.

### 1 Touch MENU.

### 2 Select [REGISTER EVENT].

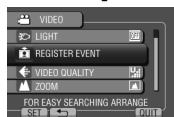

### 3 Select the event.

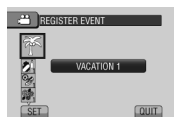

The selected event is displayed on the screen.

### ■ To quit the screen

Select [QUIT].

### ■ To search by event





See page 27.

### NOTE

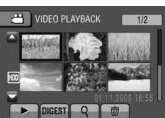

Once you select a certain event to register a file, the setting will remain even if you turn off the camcorder.

# Playing Back Files

## Video Playback

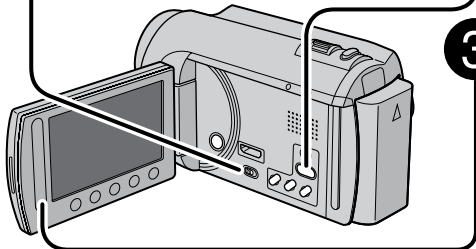
- 1** Slide the mode switch to select  (video) mode.  

- 2** Press **PLAY/REC** to select the playback mode.  
  

- 3** Select the desired file.  













■ **To move to the previous or next page**  
Touch  or  for over a second.



■ **To play back a few seconds from the beginning of each video**  
Touch **[DIGEST]**.

■ **To delete a video**  
Select  when playback is stopped.

■ **To change the number of thumbnails (6 thumbnails/20 thumbnails)**  
Move the zoom lever to **[W]**.

### ■ Operations during Video Playback On-screen buttons

- : Return to the first scene of the file
- : Go to the first scene of the next file
- : Return to the index screen
- : Reverse search (during playback)
- : Frame-by-frame playback in reverse direction (during pause)\*
- : Playback
- : Pause
- : Forward search (during playback)
- : Frame-by-frame playback in forward direction (during pause)\*

\* Slow playback starts when you keep touching the sensor button under  /  for a while.

### ■ Speaker volume



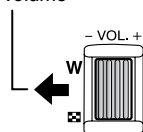

— : Turn down the volume



+ : Turn up the volume

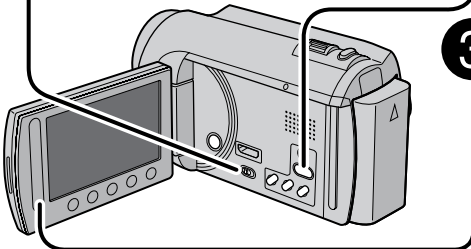

## Still Image Playback

- 1** Slide the mode switch to select  (still image) mode.  

  - 2** Press **PLAY/REC** to select the playback mode.  
  
  
The index screen appears.
  - 3** Select the desired file.  

- 

### ■ To move to the previous or next page

Touch [▲] or [▼] for over a second.

### ■ To delete a still image

Select .

### ■ To change the number of thumbnails (6 thumbnails/20 thumbnails)

Move the zoom lever to [W].



### ■ Operations during Still Image Playback On-screen buttons

- ◀ : Change playback order of slide show in reverse direction
- ▶ : Change playback order of slide show in forward direction
- : Return to the index screen
- ◀◀ : Display the previous file
- ▶▶ : Start the slide show
- || : End the slide show
- ▶▶ : Display the next file

# Playing Back Files (Continued)

## File Search Function

### Preparation:

- Select  or  mode.
- Select the playback mode.

### Group Index Screen

You can search the desired file by the group. The group is created automatically based on recording date and time. And the contents of the group are changed when adding/deleting or editing scenes.

1 Select .

2 Select [GROUP].

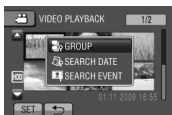

3 Select the file you want to play back.



The number of files in the group is displayed in the thumbnails.

■ To return to the index screen

Select .

■ To quit the screen

Select [QUIT].

### NOTE

- The contents of the group may be changed depending on the interval of the recording time. To change the contents, register the event. (p. 23)
- The created groups may not be listed by recording date such as when copying the files to a microSD card.

## Date Index Screen

You can search the desired file by the recording date.

1 Select .

In case of , go to step 3.

2 Select [SEARCH DATE].



3 Select the recording date.



4 Select the file you want to play back.



■ To return to the index screen

Select .

■ To quit the screen

Select [QUIT].

## Event Screen



You can search the desired file by the event that you registered the file to when recording. (p. 23) After searching by the event, you can search by the recording date to narrow down the search.

1 Select

2 Select [SEARCH EVENT].



3 Select the event.

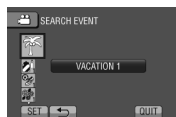

4 Select the recording date.

To display all the files, select [ALL].



5 Select the file you want to play back.



■ To return to the normal file playback mode

Select

■ To quit the screen

Select [QUIT].

■ To change the event registration of a file

See page 38.

## Playing Back MPG Files

MPG files (demonstration files, etc.) are stored in the EXTMOV folder.

Follow the procedure below to play back the MPG files in the EXTMOV folder.

**Preparation:**

- Select mode.
- Select the playback mode.

1 Touch MENU.

2 Select [PLAYBACK MPG FILE].



3 Select the file you want to play back.

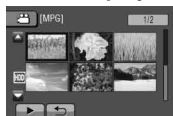

■ To return to the normal file playback mode

Select

**NOTE**



An MOD file is created in the EXTMOV folder when management information is corrupted.

# Manual Recording

Manual recording mode enables you to set the focus and screen brightness, etc. manually.

## Changing to Manual Recording Mode

### Preparation:

- Select  or  mode.
- Select the recording mode.

Select [A/M] twice.



### To return to the auto recording mode

Select [A/M] so that the  indicator appears.

## Backlight Compensation

Backlight compensation brightens the subject by increasing the exposure.

In the manual recording mode:

Select .



### To cancel backlight compensation

Select  again.

### NOTE

If the LCD monitor is turned upside down,  is not displayed. Change the setting when the LCD monitor is in the normal position.

## Manual Setting in Menu

In the manual recording mode:

- 1 Touch MENU.
- 2 Select [MANUAL SETTING].



- 3 Select the desired menu.





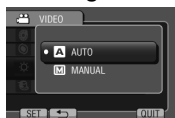























- 4 Select the desired setting.





Depending on the kind of settings you select, you can set the value by using the touch sensor.

- To return to the previous screen  
Select .
- To quit the screen  
Select [QUIT].

Menus	Settings: [ ] = Factory-preset
<p> <b>SCENE SELECT</b> Adjusts the exposure and shutter speed to suit your surroundings or the subject.</p>	<p> <b>[OFF]</b>: Deactivates the function.   <b>NIGHT</b>: Records with more sensitivity in dim locations by adjusting the shutter speed automatically.   <b>TWILIGHT</b>: Makes evening scenes look more natural.   <b>PORTRAIT</b>: The subject in the foreground is accentuated by blurring the background.   <b>SPORTS</b>: Records fast moving subjects clearly.   <b>SNOW</b>: Compensates for subjects that may appear too dark when shooting in extremely bright surroundings, such as in snow.   <b>SPOTLIGHT</b>: Select this when a spotlight makes a subject appear too bright.</p>
<p> <b>FOCUS</b> Adjusts the focus.</p>	<p> <b>[AUTO]</b>: The focus is adjusted automatically.   <b>MANUAL</b>:   <b>▲ ▲ ▼ ●</b>: Adjusts the focus manually. (When zooming, the subject will not go out of focus if you adjust the focus at the telephoto (T) side before zooming to the wide angle (W) side.)</p>
<p> <b>ADJUST BRIGHTNESS</b> Adjusts the brightness.</p>	<p> <b>mode</b>   <b>[AUTO]</b>: The brightness is adjusted automatically.   <b>MANUAL</b>:  <b>-6 to +6</b>: Corrects the brightness within this range in increments of 1.   <b>mode</b>   <b>[AUTO]</b>: The brightness is adjusted automatically.   <b>MANUAL</b>:  <b>-2.0 to +2.0 (EV)</b>: Corrects the brightness within this range in increments of 1/3EV.</p>
<p> <b>SHUTTER SPEED</b> A fast shutter speed can freeze the motion of a fast-moving subject, and a slow shutter speed can blur the subject to give the impression of motion.</p>	<p> <b>mode</b>   <b>[AUTO]</b>: The shutter speed is adjusted automatically.   <b>MANUAL</b>:  <b>1/2 to 1/4000</b>: The smaller the value, the faster the shutter speed.   <b>mode</b>   <b>[AUTO]</b>: The shutter speed is adjusted automatically.   <b>MANUAL</b>:  <b>1/2 to 1/500</b>: The smaller the value, the faster the shutter speed.    <b>NOTE</b>  It is recommended to use the tripod when recording with a slow shutter speed.</p>

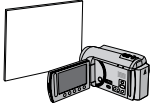
# Manual Recording (Continued)

Menus	Settings: [ ] = Factory-preset
<p><b>WB</b> <b>WB</b> Adjusts the white balance to achieve the optimum colors for the amount of light in your surroundings during recording.</p>	<p><b>A [AUTO]:</b> White balance is adjusted automatically.  <b>M [MANUAL]:</b>  <b>MWB:</b> Adjusts the white balance manually depending on the light source.</p> <ol style="list-style-type: none"> <li>1) Hold a sheet of plain white paper in front of the camcorder so that the white paper fills the screen.</li> <li>2) Keep touching <b>OK</b> until the  indicator appears.</li> </ol>  <p><b>FINE:</b> When shooting outdoors on a sunny day.  <b>CLOUD:</b> When shooting outdoors on a cloudy day.  <b>HALOGEN:</b> When a video light or similar type of lighting is used.</p>
<p><b>PHOTOMETRY AREA</b> Enables you to adjust the brightness in the desired spot when backlight compensation does not work well.</p>	<p><b>[WHOLE SCREEN]:</b> Brightness is adjusted automatically for whole screen.  <b>[SPOT]:</b> Brightness for the specified spot is adjusted automatically.</p>
<p><b>EFFECT</b> Enables you to record videos or still images with special effects.</p>	<p><b>[OFF]:</b> No effect is used.  <b>SEPIA:</b> The image has a brownish tint like old still images.  <b>B/W MONOTONE:</b> The image becomes black and white like old movies.  <b>CLASSIC FILM*:</b> This effect skips frames to give images of an old movie atmosphere.  <b>STROBE*:</b> The image looks like a series of consecutive snapshots.          *  mode only</p>
<p><b>TELE MACRO</b> Enables you to shoot a subject as large as possible at a distance of approx. 40 cm*<sup>1</sup> or 50 cm*<sup>2</sup>.</p> <p>*1 <b>GZ-MG880</b> <b>GZ-MG840</b>  <b>GZ-MG830</b></p> <p>*2 <b>GZ-MG680</b> <b>GZ-MG645</b>  <b>GZ-MG630</b></p>	<p><b>[OFF]:</b> Deactivates the function.  <b>[ON]:</b> Activates the function.</p> <p><b>NOTE</b>          Set [TELE MACRO] to [OFF] if you will not take close-up still images.          Non-close-up still images will be blurred if [TELE MACRO] is set to [ON].</p>

# Viewing Files on TV

This camcorder is designed to be used with high-definition or PAL-type color television signals. It cannot be used with a television of a different standard.

## Connection with TV

You can output videos from the AV connector or the HDMI mini connector.

### ■ To connect using the AV connector

#### Preparation:

- **GZ-MG880** **GZ-MG840** **GZ-MG830** **GZ-MG680** **GZ-MG645** Set [SWITCH TO ANALOG I/O] to [OUTPUT]. (☞ p. 63)
- Turn off all units.

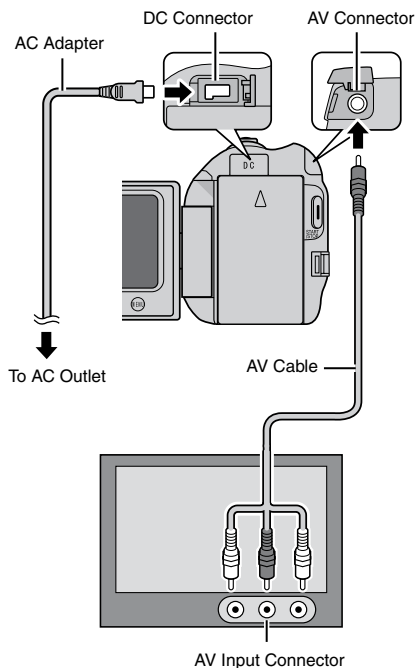

#### NOTE

**GZ-MG645** You can also connect the cables using the Everio dock.

### ■ **GZ-MG880** **GZ-MG840** **GZ-MG680** **GZ-MG645**

#### To connect using the HDMI mini connector

We recommend using the Category 2 HDMI cable (High Speed cable).

#### Preparation: Turn off all units.

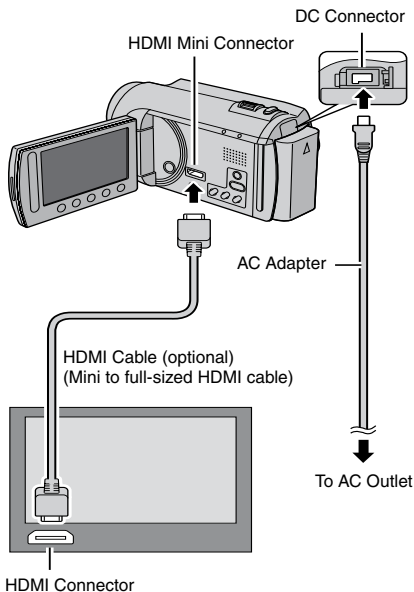

#### NOTE

- When connecting to the HDMI cable, the image or sound may not appear on the TV properly depending on the TV connected. In such cases, perform the following operations.
  - 1) Disconnect the HDMI cable and connect it again.
  - 2) Turn off and on the camcorder again.

# Viewing Files on TV (Continued)

## Playback Operation

After the connection with TV is completed

- 1** Turn on the camcorder and the TV.
- 2** Set the TV to its VIDEO mode.
- 3** (Only when connecting the camcorder to the VCR/DVD recorder)  
**Turn on the VCR/DVD recorder, and set the VCR/DVD recorder to its AUX input mode.**
- 4** Start playback on the camcorder.  
(☞ p. 24, 25)

---

■ To display camcorder's on-screen display on TV

Set [DISPLAY ON TV] to [ON]. (☞ p. 63)



# Operating in Conjunction with TV via HDMI

GZ-MG880 GZ-MG840 GZ-MG680 GZ-MG645

Connecting the camcorder to an HDMI-CEC-enabled TV using the HDMI cable allows you to utilize the following convenient functions.

- HDMI-CEC (Consumer Electronics Control) is an industry standard that enables interoperability between HDMI-CEC compliant devices that are connected via HDMI cables.

## NOTE

- Not all HDMI-control devices comply with the HDMI-CEC standard. The HDMI control function of the camcorder will not work when connected to these devices.
- The camcorder is not guaranteed to operate with all HDMI-CEC-enabled devices.
- Depending on the specifications of each HDMI-CEC-enabled device, some functions may not work with the camcorder. (For details, refer to the instruction manual of your TV.)
- Unintended operations may occur with some connected devices. In these cases, set [HDMI CONTROL] to [OFF].

## Preparation:

- Connect an HDMI cable between the camcorder and the TV. (☞ p. 31)
- Turn on the TV and set the HDMI-CEC related setting to on. (For details, refer to the instruction manual of the TV.)
- Turn on the camcorder and set [HDMI CONTROL] to [ON]. (☞ p. 63)

## ■ Operation method 1

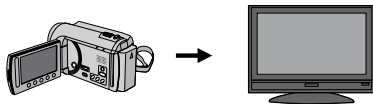

- ① Turn on the camcorder. TV turns on automatically and switches to HDMI input mode when the camcorder is turned on.
- ② Select the playback mode.
- ③ Connect the HDMI cable.

## ■ Operation method 2

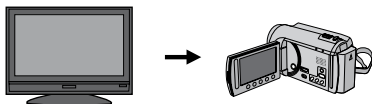

Turn off the TV.

The camcorder turns off automatically.

## ■ Operation method 3

- Depending on the TV connected, the display language of the camcorder will automatically switch to the language that is used for the TV when the camcorder is turned on. (This is applicable only if the camcorder supports the language selected for the TV.) To use the camcorder with a language that differs from the display language of the TV, set [HDMI CONTROL] to [OFF].

## NOTE

- The display language of the TV will not switch automatically, even if the display language of the camcorder is changed.
- These functions may not work correctly when devices such as amplifier and selector are connected. Set [HDMI CONTROL] to [OFF].
- If HDMI-CEC does not work properly, turn off and on the camcorder again.

# Managing Files

## CAUTION

Do not remove the recording medium or perform any other operation (such as turning off the power) while accessing files. Also, be sure to use the provided AC adapter, as the data on the recording medium may be corrupted if the battery becomes exhausted during operation. If the data on the recording medium becomes corrupted, format the recording medium to use the medium again. (p. 64)

## Capturing a Still Image from a Video

You can capture the desired scene from a recorded video, and store it as a still image.

### Preparation:

- Select  mode.
- Select the playback mode.

Press **SNAPSHOT** when playback is paused.

SNAPSHOT





## NOTE

- Captured still images are stored at a resolution of 640 x 360 (if the video was recorded in 16:9) or 640 x 480 (if the video was recorded in 4:3). The image can be elongated in the horizontal or vertical directions depending on the quality of the source video file.
- The continuous shooting function cannot be used to capture images.
- You cannot capture video during playback.

## Deleting Files

- Protected files cannot be deleted. To delete them, release the protection first.
- Once files are deleted, they cannot be restored. Check files before deleting.

### Preparation:

- Select  or  mode.
- Select the playback mode.

1 Touch **MENU**.

2 Select **[DELETE]**.

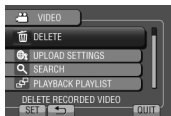

## Deleting the Currently Displayed File

After performing steps 1-2

3 Select **[CURRENT]**.

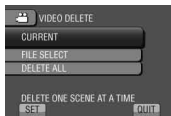

4 Select **[YES]**.



You can select the previous or next file by selecting **←** or **→**.

- **To quit the screen**  
Select **[QUIT]**.

## Deleting Selected Files

After performing steps 1-2 (☞ p. 34)

### 3 Select [FILE SELECT].

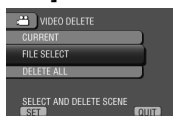

### 4 Select the desired file and select .

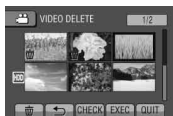

- The  mark appears on the file. To select other files, repeat this step.
- To check the content of the file, select [CHECK].

### 5 Select [EXEC].

### 6 Select [YES].

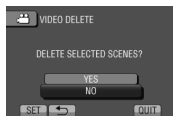

### ■ To quit the screen

Select [QUIT].

## Deleting All Files

After performing steps 1-2 (☞ p. 34)

### 3 Select [DELETE ALL].

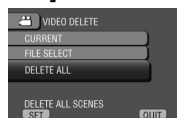

### 4 Select [YES].



### ■ To quit the screen

Select [QUIT].

# Managing Files (Continued)

## Protecting Files

### Preparation:

- Select or mode.
- Select the playback mode.

1 Touch MENU.

2 Select [EDIT].



3 Select [PROTECT/CANCEL].

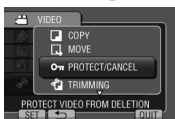

## Protecting the Currently Displayed File

After performing steps 1-3

4 Select [CURRENT].



5 Select [YES].



You can select the previous or next file by selecting or .

### ■ To quit the screen

Select [QUIT].

## Protecting Selected Files

After performing steps 1-3

4 Select [FILE SELECT].

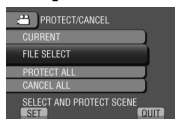

5 Select the desired file and select .



- The (protection) mark appears on the file. To select other files, repeat this step.
- To check the content of the file, select [CHECK].

6 Select [QUIT].

7 Select [YES].



### ■ To release protection

Select the protected file in step 5.

## Protecting All Files

After performing steps 1-3 (➡ p. 36)

### 4 Select [PROTECT ALL].

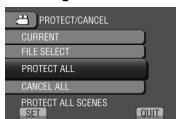

### 5 Select [YES].



#### ■ To quit the screen

Select [QUIT].

#### ■ To release protection of all files

- 1) In step 4, select [CANCEL ALL].
- 2) Select [YES].

## Viewing File Information

### Preparation:

#### 👤 mode:

Pause the playback. Otherwise, select the file on the index screen.

#### 📷 mode:

Play back the still image. Otherwise, select the file on the index screen.

### Press INFO.



- **FILE:**  
File name
- **FOLDER:**  
Folder name
- **DATE/TIME:**  
Date and time of the recording
- **PB TIME (👤 mode):**  
Playback time (length of the file)
- **SIZE (📷 mode):**  
Image size
- **QUALITY:**  
Video quality/Image quality (➡ p. 60)
- **PROTECT:**  
File protection status (➡ p. 36)

#### ■ To turn off the file information display

Press **INFO** again.

# Managing Files (Continued)

## Changing the Event Registration

### Preparation:

- Select **FILE** mode.
- Select the playback mode.

**1** Touch **MENU**.

**2** Select **[EDIT]**.



**3** Select **[CHANGE EVENT REG.]**.



## Changing the Event of the Currently Displayed File

After performing steps 1-3

**4** Select **[CURRENT]**.



**5** Select the file you want to register.



You can select the previous or next file by selecting **←** or **→**.

**6** Select a new event.

To cancel the event registration, select **[CANCEL]**.



## Changing the Event of the Selected Files

After performing steps 1-3

**4** Select **[SET RANGE AND CHANGE]**.



**5** Select the first file of the range.



To preview scenes, select the file and select **[CHECK]**.

**6** Select the last file of the range.

**7** Select a new event.

To cancel the event registration, select **[CANCEL]**.



■ **To quit the screen**  
Select **[QUIT]**.

## Trimming Files

You can select the necessary part of the video and save it as a new video file.

### Preparation:

- Select **FILE** mode.
- Select the playback mode.

### 1 Touch MENU.

### 2 Select [EDIT].



### 3 Select [TRIMMING].



### 4 Select the desired file.

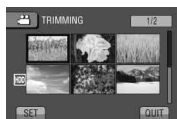

### 5 Select [SET] at the start point.

It is recommended to select [SET] after the pause button is pressed.



Use these controls to locate the start point.

### 6 Select [SET] at the end point.

It is recommended to select [SET] after the pause button is pressed.



To cancel the start point setting, select [CANCEL].

### 7 Select [CAPTURE TRIMMED FILE].



To set the start/end point again, select [REDEFINE AREA].

### 8 Select [YES].

When copying is finished, the copied file is added to the index screen.

### 9 Touch OK.

#### ■ To quit the screen

Select [QUIT].

# Playlists

It is a list that enables you to organize recorded videos in order of preference.

## Preparation:

- Select **FILE** mode.
- Select the playback mode.

## Creating Playlists

### 1 Touch MENU.

### 2 Select [EDIT PLAYLIST].

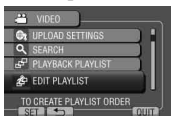

### 3 Select [NEW LIST].



### 4 Select an item and display files.



- **[CREATE FROM SCENE]:**  
Display all files individually.
- **[CREATE BY DATE]:**  
Display all the files listed by recording date.
- **[CREATE BY GROUP]:**  
Display all files listed by group.
- **[CREATE BY EVENT]:**  
Search for an event and display the corresponding files listed by recording date.

### 5 Select the file to add to playlist.



To preview scenes, select the file and select [CHECK].

### 6 Select the insertion point.



- To add other files, repeat steps **5** and **6**.
- To delete a registered scene, select the registered file, then select [CANCEL].

### 7 Select [SAVE].

### 8 Select [SAVE AND QUIT].

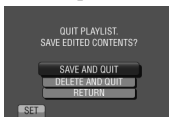

### ■ To quit the screen

Select [QUIT].

### ■ To add a picture title after creating a playlist

See page 42.

### NOTE

- A maximum of 99 playlists can be created.
- If you delete the original files, the corresponding files are also deleted from the playlist.



## Creating Playlists Including Picture Titles

You can easily create a playlist including a picture title.

### 1 Press TITLE.

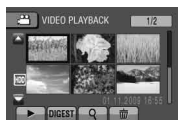

### 2 Select the desired picture title.

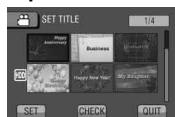

You can check the picture title in full-screen by selecting [CHECK].

### 3 Select the desired file.



You can check the scene by selecting [CHECK].

### 4 Select [OK].

#### ■ To return to the previous screen

Select [OK].

#### ■ To quit the screen

Select [QUIT].

## Playing Back Playlists

### 1 Touch MENU.

### 2 Select [PLAYBACK PLAYLIST].

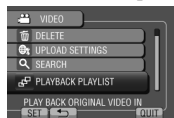

### 3 Select the playlist.

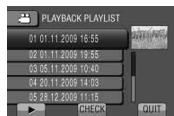

#### ■ To stop playback

Select [STOP].

#### ■ To quit the screen

Select [QUIT].

#### ■ To play back from the desired scene

- 1) In step 3, select [CHECK]. (The index screen for playlist appears.)
- 2) Select the desired scene.

#### NOTE

- When playing back a playlist with a picture title, playback starts after the title is displayed for 5 seconds.
- When adding a picture title to playlist,  mark appears on the left side of the file name.

# Playlists (Continued)

## Other Operations of Playlists

You can perform additional editing and delete files in a created playlist.

### Adding/Deleting Files in Playlist

After performing steps 1-2 (☞ p. 40)

- 3** Select [EDIT].
- 4** Select the playlist you want to edit.  
To add or delete files, follow the steps 5 to 8. (☞ p. 40)

### Deleting Playlist

Original files are not deleted even if you delete the playlist.

After performing steps 1-2 (☞ p. 40)

- 3** Select [DELETE].
- 4** Select a playlist you want to delete.  
To delete all playlists at once, select [DELETE ALL].
- 5** When [DELETE PLAYLIST?] appears, select [YES].

### Adding a Picture Title to Playlist

After performing steps 1-2 (☞ p. 40)

- 3** Select [SET TITLE].
- 4** Select the desired playlist.
- 5** Select the desired picture title.

# Copying Files

## Types of Copying and Connectable Device



### The Camcorder

You can copy files between the HDD and microSD card with this camcorder alone.

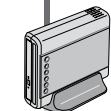

### DVD Burner (CU-VD50/CU-VD3)

You can copy files recorded on this camcorder onto DVD discs.



### PC

You can copy files from the camcorder to a DVD using a PC.



### VCR/DVD Recorder

You can dub video recorded on this camcorder onto VCR/DVD recorder.

#### NOTE

It is recommended to use the JVC DVD burner (CU-VD50/CU-VD3). When using CU-VD20 or CU-VD40, the recording time may take approx. 2 times longer than the time that is described in the instruction manual of DVD burner.

## Copying/Moving Files

You can copy or move files between the HDD and microSD card.

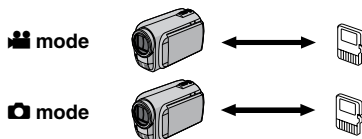

### Preparation:

- Select mode or mode.
- Select the playback mode.
- Make sure that microSD card is inserted in the microSD slot.
- Make sure that enough free space is left in the copy/move destination medium.

## 1 Touch MENU.

## 2 Select [EDIT].



## 3 Select [COPY] or [MOVE].



- **[COPY]:**  
Files are copied to the destination medium while leaving original files in the source medium.
- **[MOVE]:**  
Files are moved to the destination medium while deleting original files in the source medium.

# Copying Files (Continued)

- 4 Select the direction.  
([HDD → SD] or [SD → HDD])



- 5 Select the desired menu.



● **[COPY ALL]/[MOVE ALL]:**

Select this to transfer all files in the recording medium.

When the size of all files in the HDD is larger than the free space of the microSD card, only the files that can be contained in the free space will be copied.

● **[SELECT AND COPY]/[SELECT AND MOVE]:**

Select when you want to transfer the selected files.

- 1) Select the desired file, and touch **OK**.  
The **✓** mark appears on the file. To select other files, repeat this step.
- 2) Select **[EXEC]**.

- 6 Select **[YES]**.



File transfer starts. When **[COPYING COMPLETED]** / **[MOVING COMPLETED]** appears, touch **OK**.

■ **To quit the screen**

Select **[QUIT]**.

■ **To stop the file transfer**

- 1) Select **[STOP]**.
- 2) When **[QUIT?]** appears, select **[YES]**.

## Using a DVD Burner

Supported discs: 12cm DVD-R, DVD-RW

- Regarding DVD-R discs, only unused DVD-R discs can be used. Regarding DVD-RW discs, used DVD-RW discs can also be used, but they need to be formatted before recording. Formatting a disc deletes all content recorded on the disc up until that time.
- Dual-layer discs cannot be used.

### Regarding finalization after copying

The disc is automatically finalized so that it can be played on other devices. After finalizing, the disc is a play-only disc, so no more files can be added.

## Connection with a DVD Burner

### Preparation:

Turn on the camcorder first, then turn on the DVD burner.

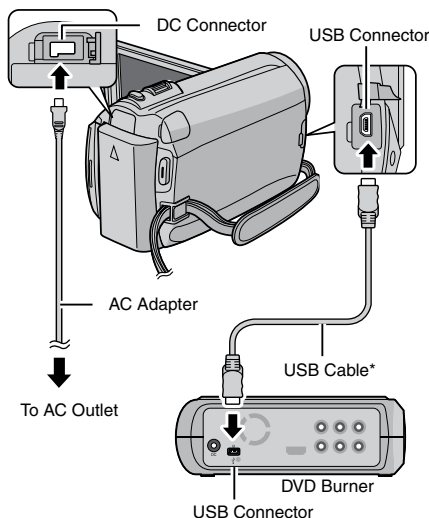

**NOTE**

- Refer also to the optional DVD burner's instruction manual.
- \* Use the USB cable that came with the DVD burner.

## Backup All Files

### Preparation:

- Connect the camcorder to the DVD burner.
- Select  mode.

### 1 Select [CREATE FROM ALL].



### 2 Select the desired menu.

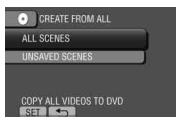

#### • [ALL SCENES]:

All files in the recording medium are copied.

#### • [UNSAVED SCENES]:

Files that have never been copied to a DVD disc are automatically selected and copied.

### 3 Select the desired disc number.



- If you select [ALL], all discs in the list are created.
- To preview scenes, select [CHECK].
-  mark shows that the disc is created already.

### 4 Select [YES] or [NO].

- [YES]: Displays the thumbnails by group.
- [NO]: Displays the thumbnails by date.

### 5 Select [EXECUTE].

- The files are copied on the disc. When [COMPLETED] appears, touch **OK**.
- When [INSERT NEXT DISC PRESS [STOP] TO EXIT CREATE] appears, change the disc. Remaining files are copied on the second disc.
- To cancel copying, select [STOP].

## Copying Video Files that Have Never Been Copied

Files that have never been copied to the DVD discs are automatically selected and copied.

### 1 Open the LCD monitor to turn on the camcorder.

### 2 Press DIRECT DVD.



### 3 Select [EXECUTE].



- The DVD disc begins to be created. When [COMPLETED] appears, touch **OK**.
- When [INSERT NEXT DISC PRESS [STOP] TO EXIT CREATE] appears, change the disc. Remaining files are copied on the second disc.
- To cancel the DVD creation, select [CANCEL].

### ■ To quit the screen

- 1) Select [QUIT].
- 2) When [QUIT?] appears, select [YES].

# Copying Files (Continued)

## Selecting Files for Backup

### Preparation:

- Connect the camcorder to the DVD burner.
- Select  mode.

### 1 Select [SELECT AND CREATE].

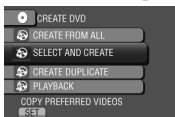

### 2 Select the desired menu.

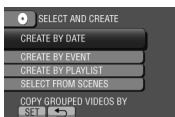

- **[CREATE BY DATE]:**  
Files are sorted according to the date on which they were recorded. Relevant files are displayed in a list. Select the recording date.
- **[CREATE BY EVENT]:**  
Files are sorted according to event. Relevant files are displayed in a list. Select the event.
- **[CREATE BY PLAYLIST]:**  
Select the desired playlist from the list of playlists. The selected playlists are displayed in a list.
  - 1) Select the desired list.
  - 2) Select the insertion point. To select other lists, repeat this process.
  - 3) Select [SAVE].
- **[SELECT FROM SCENES]:**  
Select files individually.
  - 1) Select the desired file. To select other files, repeat this process.
  - 2) Select [SAVE].

### 3 Select the desired disc number.



- If you select [ALL], all discs in the list are created.
- To preview scenes, select [CHECK].
-  mark shows that the disc is created already.

### 4 Select [YES] or [NO].

- [YES]: Displays the thumbnails by group.
- [NO]: Displays the thumbnails by date.

### 5 Select [EXECUTE].

- The files are copied on the disc. When [COMPLETED] appears, touch **OK**.
- When [INSERT NEXT DISC PRESS [STOP] TO EXIT CREATE] appears, change the disc. Remaining files are copied on the second disc.
- To cancel copying, select [STOP].

### ■ To quit the screen

- 1) Select [QUIT].
- 2) When [QUIT?] appears, select [YES].

### NOTE

In case of [CREATE BY PLAYLIST], date/time on the file information display shows the date of copying the file, instead of the actual recording date.

### ■ To duplicate a disc

The last creation date is displayed. (Up to 20 files)

- 1) In step 1, select [CREATE DUPLICATE].
- 2) Select the date and go to step 5.

### ■ To check whether the DVD disc was created properly

In step 1, select [PLAYBACK].

## ■ To play back the created disc using the camcorder

- 1) Connect the camcorder to the DVD burner.
- 2) Turn on the camcorder first, then turn on the DVD burner.
- 3) Select [PLAYBACK].
- 4) Select the desired folder.
- 5) Select the creation date of the disc.
- 6) Select the desired file. To return to the previous screen, select .

## ■ Disc number

Disc number shows the number of DVD discs you can create. The dubbing range of each disc is automatically allocated, presuming that all the files are to be dubbed from the first one on the list. This dubbing range cannot be changed.

E.g.) "DVD1" can contain two files, "01.01.2009" and "15.01.2009".

DVD1	01.01.2009 09:05
	15.01.2009 12:15
DVD2	01.02.2009 12:04
	08.02.2009 12:15

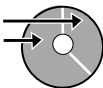

## ■ Title and chapter of created DVD

Each recording date becomes one title in a created DVD and each file recorded in a same day becomes one chapter in the title.

10. 01. 2009: file 1 and 2 were recorded.

File 1	File 2
--------	--------

11. 01. 2009: file 3 and 4 were recorded.

File 3	File 4
--------	--------



Create a DVD

Title

10.01.2009	11.01.2009
------------	------------

File 1	File 2	File 3	File 4
--------	--------	--------	--------

1	2	3	4
---	---	---	---

Chapter

## Digest Playback

You can view a few seconds from the beginning of each video (digest) in the created DVD.

Create a DVD using a DVD burner (CU-VD50/ CU-VD3).

- 1 Load the created DVD on the DVD player.
- 2 On the TV, select [DIGEST PLAYBACK].\*



You can view the previous or next page by selecting < / >.

\* The screen does not appear on the camcorder.

- 3 The digest is played back continuously.

## ■ To normal playback / To the index menu

- 1) Press the top menu button on the remote control of the DVD device during the digest playback.
- 2) Select the desired item.

### NOTE

"Digest Playback" menu is not available when DVD is burned using the provided MediaBrowser software.

# Copying Files (Continued)

## Creating a DVD using a PC

You can copy the data from the camcorder and create a DVD using a PC.

### 1 Installing the software to the PC

#### System Requirements

##### Windows Vista

OS: Windows Vista®  
Home Basic (SP1)  
Home Premium (SP1)  
(32-bit, pre-installed)

CPU: Either one of the following:  
• Intel® Pentium® 4, 1.6 GHz or higher  
• Intel® Pentium® M, 1.4 GHz or higher  
• Intel® Core™ Duo, 1.5 GHz or higher

RAM: At least 1 GB

##### Windows XP

OS: Windows® XP  
Home Edition (SP2/SP3)  
Professional (SP2/SP3)  
(pre-installed)

CPU: Either one of the following:  
• Intel® Pentium® 4, 1.6 GHz or higher  
• Intel® Pentium® M, 1.4 GHz or higher  
• Intel® Core™ Duo, 1.5 GHz or higher

RAM: At least 512 MB

### ■ To check the PC specification

Right-click on [Computer] (or [My Computer]) in the [Start] menu and select [Properties].

#### NOTE

- Make sure your PC has a recordable DVD drive.
- If your system does not meet the requirements, it is recommended to copy files using the DVD burner. (p. 44)
- Macintosh users may use the software included with their Macintosh (iMovie '08, iPhoto) to copy files to their computer.

### Preparation:

Load the provided CD-ROM into the PC. In Windows Vista, the auto play dialog box appears.

### 1 Click [Easy Installation].



Follow the on-screen instructions.

### 2 Click [Next].



### 3 Click [Finish].



Everio MediaBrowser icon is created on the desktop.

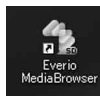

### ■ To see the Instruction Guide for Everio MediaBrowser

- 1) Double-click the icon of Everio MediaBrowser.
- 2) Click [Help], and click [MediaBrowser Help].





## 2 Making Backup on the PC

### Preparation:

- Install the software to the PC.
- Make sure that enough free space is left in the PC's HDD.
- Close the LCD monitor to turn off the camcorder.

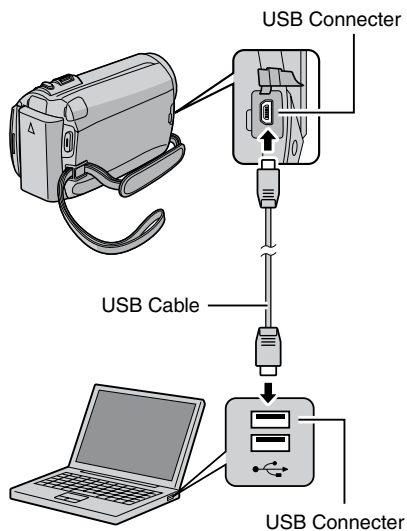

1 Open the LCD monitor to turn on the camcorder.

2 Select [BACK UP].

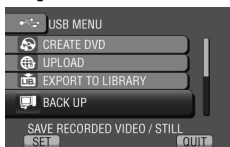

Everio MediaBrowser starts on the PC.



3 Click [All volume in camcorder] and click [Next].



4 Click [Start].



Backup starts.

### To disconnect the camcorder from the PC

- 1) Right-click the icon (Safely Remove Hardware) on the task bar and select [Safely remove USB Mass Storage Device].
- 2) Follow the on-screen instructions and make sure that the device can be safely removed.
- 3) Disconnect the USB cable and close the LCD monitor.

### NOTE

It takes time to back up many videos.

# Copying Files (Continued)

## 3 Making User Lists to Arrange the Files

You can make a user list of a certain subject (such as Travel, Athletic meet) and put the files related to the subject into the user list.

### Preparation:

Make backup on the PC.

## 1 Double-click the icon and open the calendar.



## 2 Select [Movies only].



## 3 Click [+].



## 4 Input the name of the new user list and click [OK].

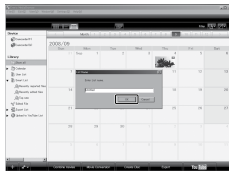

## 5 Double-click the recording date.



The files recorded on the day are displayed.

## 6 Drag the file and drop into the user list.



To add other files into the user list, repeat steps 5 and 6.

## 1 Copying Files to a DVD

### Preparation:

Use a recordable DVD disc. (It is recommended to use a DVD-R disc.)

### 1 Select the user list and click [Create Disc].



### 2 Click [Select files individually] and click [Next].

To add all the files onto DVD discs, click [Select all files displayed], then go to step 4.



### 3 Drag the file, and drop into the part at the bottom and click [Next].



### 4 Input the disc name, select the top menu style and click [Next].



### 5 Click [Start].



### NOTE

- For detail on operating Everio MediaBrowser, click [Help] and refer to [MediaBrowser Help].
- Adobe® Reader® must be installed to read [MediaBrowser Help]. Adobe® Reader® can be loaded from Adobe's web site: <http://www.adobe.com>
- For assistance in operating the provided software, refer to the support information. (p. 52)

# Copying Files (Continued)

## Folder Structure and Extensions

Recording medium

X = number

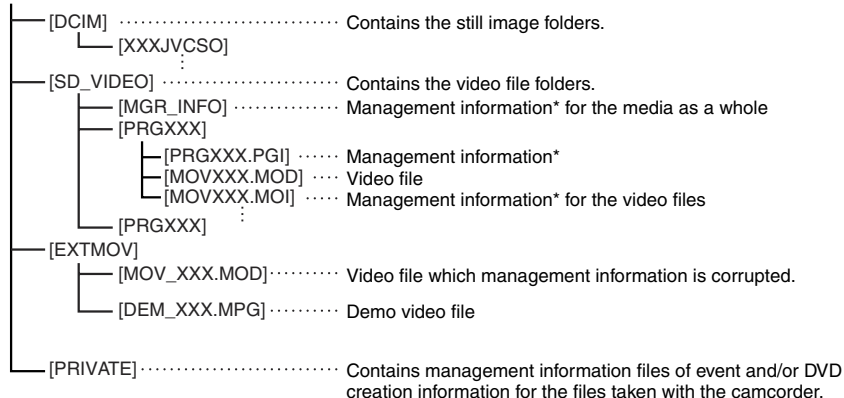

\* Information such as the date and time of recording, recorded with the video file.

## Customer Support Information

Use of this software is authorized according to the terms of the software license.

### JVC

When contacting the nearest JVC office or agency in your country (refer to the JVC Worldwide Service Network at <http://www.jvc-victor.co.jp/english/worldmap/index-e.html>) about this software, please have the following information ready.

- Product Name, Model, Problem, Error Message
- PC (Manufacturer, Model (Desktop/Laptop), CPU, OS, Memory (MB), Available Hard Disk Space (GB))

Please note that it may take some time to respond to your questions, depending on their subject matter. JVC cannot answer questions regarding basic operation of your PC, or questions regarding specifications or performance of the OS, other applications or drivers.

### Pixela

Region	Language	Phone #
USA and Canada	English	+1-800-458-4029 (toll-free)
Europe (UK, Germany, France, and Spain)	English/German/French/Spanish	+800-1532-4865 (toll-free)
Other Countries in Europe	English/German/French/Spanish/ Italian/Dutch	+44-1489-564-764
Asia (Philippines)	English	+63-2-438-0090
China	Chinese	+86-21-5385-3786

**Homepage:** <http://www.pixela.co.jp/oem/jvc/mediabrowser/e/>

Please check our website for latest information and downloading.

## Dubbing Files to a VCR/DVD Recorder

### Preparation:

- Create a playlist.
- **GZ-MG880** **GZ-MG840** **GZ-MG830** **GZ-MG680**  
**GZ-MG645** Set [SWITCH TO ANALOG I/O] to [OUTPUT]. (☞ p. 63)
- Turn off all units.

### ■ To connect using the AV connectors (analog dubbing)

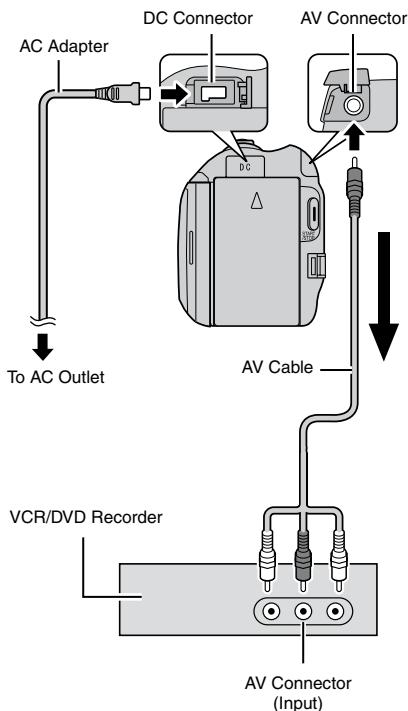

**1** Open the LCD monitor to turn on the camcorder.

**2** Set the VCR/DVD recorder to its **AUX input mode**.

Check that the images from the camcorder are input correctly to the VCR/DVD recorder.

**3** Play back playlists on the camcorder.

- 1) Touch **MENU**.
- 2) Select [DUBBING PLAYBACK].
- 3) Select the desired playlist.
- 4) Select [YES]. (A black screen is displayed for 5 seconds at the first and the last scene.)

**4** At the point you want to start dubbing, start recording on the VCR/DVD recorder.

Refer to the VCR/DVD recorder's instruction manual.

### ■ To stop dubbing

Stop recording on the VCR/DVD recorder.

### ■ To hide the date or icons on the screen

Change the settings in [DISPLAY ON TV]. (☞ p. 63)

### NOTE

**GZ-MG645** You can also connect the cables using the Everio dock.

### Switching indication modes on LCD monitor

Each time you touch **DISPLAY**, indications on LCD monitor switch as shown below:

In recording mode:

All indications/Indications for selected functions

In playback mode:

All indications/Only date and time/No indications

# Copying Files (Continued)

GZ-MG880 GZ-MG840 GZ-MG830

GZ-MG680 GZ-MG645

## Dubbing Files from a VCR/DVD Player

### Preparation:

- Set [SWITCH TO ANALOG I/O] to [INPUT]. (p. 63)
- Turn off all units.

### ■ To connect using the AV connectors (analog dubbing)

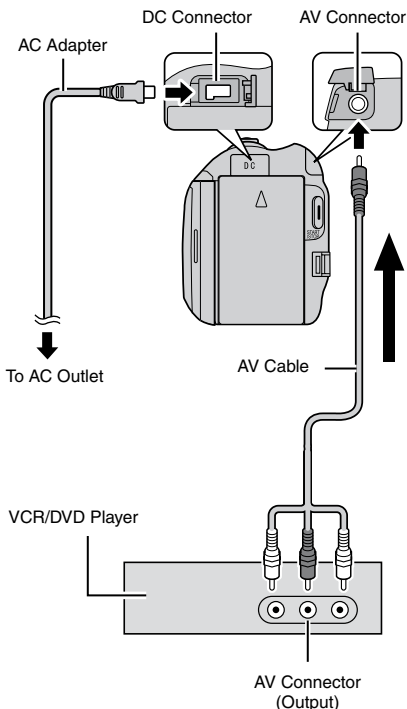

**1** Open the LCD monitor to turn on the camcorder.

**2** Start playback on the VCR/DVD player.

**3** Press **START/STOP** on the camcorder at the scene where you want to start recording.

### ■ To stop recording

Press **START/STOP** again.

### NOTE

- If [COPY PROTECTED CONTENT] appears, the file is protected and cannot be recorded.
- If the videos you want to record contain both 16:9 and 4:3 screen size, recording stops where the aspect ratio switches. To record such videos, you need to perform recording operation at every switching point.
- **GZ-MG645** You can also connect the cables using the Everio dock.

# Using with a Portable Media Player

## Turning on the Export Mode

You can easily transfer videos recorded in export mode to iTunes®. All the files with the export setting turned on are transferred to PC. For details on transferring, refer to the operation guide of MediaBrowser in the CD-ROM.

### Preparation:

- Select  mode.
- Select the recording mode.

Press **EXPORT** twice.



EXPORT

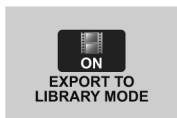

---

### ■ To turn off the export mode

Press **EXPORT** twice.

## Changing the Export Setting

You can set the recorded videos to the export setting.

### Preparation:

- Select  mode.
- Select the playback mode.

### 1 Press **EXPORT**.



EXPORT

### 2 Select the file and set [**LIB.**].



- To check the content of the file, select [**CHECK**].

### 3 Select [**DONE**].

---

#### ■ To cancel the export setting

Select the file and select [**LIB.**] again.

#### ■ To quit the screen

- 1) Select [**DONE**].
- 2) Select [**YES**].

#### ■ To confirm the export setting

Press **EXPORT** on the index screen.

# Using with a Portable Media Player (Continued)

## Transferring the Files to PC

### Preparation:

Install iTunes® on a PC.

<http://www.apple.com/itunes/>

- 1** Connect the camcorder to the PC with the USB cable.
- 2** Select [EXPORT TO LIBRARY].



All the files with the export setting turned on are transferred to PC.



## Turning on the Upload Mode

You can upload the file to video sharing websites (YouTube™) quickly after recording.

### Preparation:

- Select mode.
- Select the recording mode.

Press **UPLOAD** twice.



If you record a file with the upload mode set on, the recording stops automatically 10 minutes after the recording is started. The remaining time is displayed on the LCD monitor.

### NOTE

The upload mode turns off each time recording is finished.

## Upload Trimming

You can select the necessary part of the video and save it as a new video file ready for uploading.

### Preparation:

- Select mode.
- Select the playback mode.

1 Touch **MENU**.

2 Select [**UPLOAD SETTINGS**].

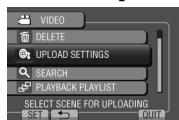

3 Select the desired file.

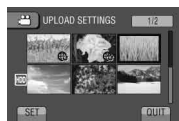

4 Select [**SET**] at the start point.



5 Select [**SET**] at the end point.



- The duration between the start point and the end point cannot be longer than 10 minutes.
- To cancel the start point setting, select [**CANCEL**].

# Uploading Files to Websites (Continued)

## 6 Select [CAPTURE TRIMMED FILE].



To set the start/end point again, select [REDEFINE AREA].

## 7 Select [YES].

When copying is finished, the copied file is added to the index screen.

- 
- **To quit the screen**  
Select [QUIT].

## Uploading Files

For details on uploading files, refer to the operation guide of MediaBrowser in the CD-ROM.

## 1 Connect the camcorder to the PC with the USB cable.

## 2 Select [UPLOAD].

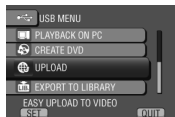

# Changing the Menu Settings

1 Touch MENU.

2 Select the desired menu.

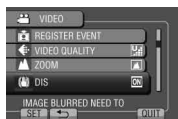

3 Select the desired setting.



■ To return to the previous screen















Select [BACK].











■ To quit the screen

Select [QUIT].





Mode	Menus	Settings: [ ] = Factory-preset
	<b>M</b> <b>MANUAL SETTING</b>	See page 28. (In the manual recording mode only)
	<b>L</b> <b>LIGHT</b>	See page 22.
	<b>R</b> <b>REGISTER EVENT</b>	See page 23.
	<b>S</b> <b>SELF-TIMER</b> Starts recording when the set time elapses after <b>SNAPSHOT</b> is pressed.	<b>[OFF] / 2SEC / 10SEC</b> <b>NOTE</b> <ul style="list-style-type: none"> <li>You can confirm the countdown on the camcorder screen.</li> <li>It is recommended to attach the camcorder to a tripod and use this function to prevent the vibration after <b>SNAPSHOT</b> is pressed.</li> </ul>
	<b>SHUTTER MODE</b> Records still images continuously while <b>SNAPSHOT</b> is pressed.	<b>[RECORD ONE SHOT]</b> : Records one still image at a time. <b>CONTINUOUS SHOOTING</b> : Records still images continuously while <b>SNAPSHOT</b> is pressed. <b>NOTE</b> <ul style="list-style-type: none"> <li>The interval between recording still images is approx. 0.3 seconds.</li> <li>Continuous shooting may not work well depending on the recording medium.</li> <li>The continuous shooting speed will drop if this function is used repeatedly.</li> </ul>
	<b>GZ-MG880/GZ-MG840/GZ-MG830</b> <b>IMAGE SIZE</b> Selects the image size for still images.	<b>[1152X864(1M)] / 640X480(0.3M)</b>









## Changing the Menu Settings (Continued)

Mode	Menus	Settings: [ ] = Factory-preset
	 <b>VIDEO QUALITY</b> Sets the video quality.	[ULTRA FINE] / FINE / NORMAL / ECONOMY
	 <b>IMAGE QUALITY</b> Sets the image quality.	[FINE] / STANDARD
	 <b>ZOOM</b> Sets the maximum zoom ratio.	<p>[GZ-MG880] [GZ-MG840] [GZ-MG830] 32X/OPTICAL / 38X/DYNAMIC* / [76X/DIGITAL] / 800X/DIGITAL</p> <p>* Dynamic zoom The combination of optical and digital zoom technology offers higher zoom ratio than optical zoom without reducing the quality.</p> <p><b>NOTE</b> Optical zoom is used up to [32X/OPTICAL]. Digital zoom is used from more than [32X/OPTICAL] up to the selected zoom ratio.</p> <p>[GZ-MG680] [GZ-MG645] [GZ-MG630] 35X/OPTICAL / [70X/DIGITAL] / 800X/DIGITAL</p> <p><b>NOTE</b> Optical zoom is used up to [35X/OPTICAL]. Digital zoom is used from more than [35X/OPTICAL] up to the selected zoom ratio.</p>
	 <b>DIS</b> Compensates for hand shake.	<p><b>OFF:</b> Deactivates the function. <b>[ON]:</b> Activates the function.</p> <p><b>NOTE</b></p> <ul style="list-style-type: none"> <li>• Complete stabilization may not be possible if hand shake is excessive, or depending on the shooting conditions.</li> <li>• Switch off this mode when recording with the camcorder on a tripod.</li> </ul>
	 <b>GAIN UP</b> Makes the subject appear bright automatically when you record in dark places. However, the overall color tones appear grayish.	<p><b>OFF:</b> Deactivates the function. <b>AGC:</b> Electrically brightens the scene in dark place. <b>[AUTO]*:</b> Automatically brightens the scene when it is dark. (Becomes brighter than [AGC]. The motion of a subject may look unnatural if recorded in some condition.)</p> <p>*  mode only</p>
	 <b>SELECT ASPECT RATIO</b> Selects the aspect ratio for videos.	<p>[16:9]: Records videos in 16:9 size. 4:3: Records videos in 4:3 size.</p> <p><b>NOTE</b></p> <ul style="list-style-type: none"> <li>• If the [VIDEO QUALITY] is set to [ECONOMY], you cannot record in 16:9 size.</li> <li>• If you want to copy the recorded videos onto DVD discs, it is recommended not to mix 16:9 size videos and 4:3 size videos.</li> </ul>
	 <b>WIND CUT</b> Reduces noise caused by wind.	<p>[OFF]: Deactivates the function. <b>ON:</b> Activates the function.</p>







Menus	Settings: [ ] = Factory-preset
 <b>DISPLAY SETTINGS</b>	Select [DISPLAY SETTINGS], then select sub-menus.
 <b>LANGUAGE</b> Sets the display language.	AA/AG/AS model: [ENGLISH] AH model: [汉语] See page 17.
 <b>CLOCK ADJUST</b> Sets the time.	See page 16.
 <b>DATE DISPLAY STYLE</b> Sets the date and time display format.	<b>DATE STYLE:</b> month.day.year / year.month.day / [day.month.year] <b>TIME:</b> [24h] / 12h
 <b>MONITOR BRIGHT</b> Sets the brightness of the LCD monitor.	Adjusts the brightness of the display by using the touch sensor.
 <b>MONITOR BACKLIGHT</b> Enables you to adjust the brightness of backlight on the monitor.	<b>[BRIGHTER]*1:</b> Brightens the backlight on the monitor regardless of the surrounding conditions. <b>STANDARD:</b> Select this when saving the battery life. <b>[AUTO]*2:</b> The brightness will automatically be set to [BRIGHTER] when using outdoors and to [STANDARD] when using indoors (when using the battery pack). *1 AS model *2 AA/AG/AH model
 <b>BASIC SETTINGS</b>	Select [BASIC SETTINGS], then select sub-menus.
 <b>DEMO MODE</b> Introduces special features of the camcorder when there is no operation for about 3 minutes during recording mode.	<b>OFF:</b> Deactivates the function. <b>[ON]:</b> Activates the function. <b>NOTE</b> • The demonstration only works when the AC adapter is connected, not with the battery pack. • If a microSD card is in the camcorder, demonstration will not take place even if this mode is set to [ON].
 <b>AUTO POWER OFF</b> If the camcorder is not operated for 5 minutes while the power is on, it turns itself off automatically to conserve power.	<b>OFF:</b> Disables the function. <b>[ON]:</b> Activates the function. To turn the camcorder on again, close the LCD monitor and open it again when using the battery pack. When using the AC adapter, perform any operation such as zooming.
 <b>OPERATION SOUND</b> Turns on/off the operation sound.	<b>OFF:</b> Turns off the operation sound. <b>[ON]:</b> The melody sounds when operations are performed.

## Changing the Menu Settings (Continued)

Menus	Settings: [ ] = Factory-preset
<b>REC RECORD BUTTON</b> Enables the recording button [REC] on the LCD monitor.	<b>OFF:</b> Deactivates the function. <b>[ON]:</b> Activates the function.
 <b>QUICK RESTART</b> Enables the camcorder to start up quickly when you turn off the camcorder and then on again within 5 minutes by closing and opening the LCD monitor.	<b>OFF:</b> Deactivates the function. <b>[ON]:</b> If the LCD monitor is opened again within 5 minutes, the camcorder starts quickly. The power consumption used for the 5 minute period after the LCD monitor is closed is approximately 1/3 that used during recording. This enables you to save more power than leaving the power on.
 <b>DROP DETECTION</b> Prevents damage to the HDD by turning off the power automatically when it is detected that the camcorder dropped.	<b>OFF:</b> Deactivates the function. <b>[ON]:</b> Activates the function. To turn on the camcorder when the drop detection worked, close the LCD monitor and open it again.  <b>NOTE</b> <ul style="list-style-type: none"> <li>• The built-in hard disk of the camcorder may not be protected even if the setting is [ON].</li> <li>• When recording/playback stops even if the camcorder is not dropped, set the setting to [OFF] or set [REC MEDIA FOR VIDEO] to [SD]. (▶ p. 64)</li> </ul>
 <b>REMOTE</b> Turns on/off reception of the operation signal from the remote control.	<b>OFF:</b> Does not receive the signal from the remote control. <b>[ON]:</b> Enables operation with the remote control.
 <b>UPDATE</b> Updates and improves the system software.	<b>YES:</b> Performs this function. <b>[NO]:</b> Cancels this function.  <b>NOTE</b> Information about obtaining system update will be made available on the JVC's web site.
 <b>FACTORY PRESET</b> Returns all the camcorder settings to their default values.	<b>YES:</b> Performs this function. <b>[NO]:</b> Returns to the menu screen without executing reset.

Menus	Settings: [ ] = Factory-preset
 <b>CONNECTION SETTINGS</b>	Select [CONNECTION SETTINGS], then select sub-menus.
 <b>DISPLAY ON TV</b> Displays camcorder's on-screen display on a TV screen.	<b>[OFF]:</b> Does not display on TV. <b>ON:</b> Displays on TV.
 <b>VIDEO OUTPUT</b> Sets the aspect (16:9/4:3) to the screen of the connected television when outputting videos from the AV connector.	<b>4:3 / [16:9]</b>
<div style="border: 1px solid black; padding: 2px; margin-bottom: 5px;">GZ-MG880</div> <div style="border: 1px solid black; padding: 2px; margin-bottom: 2px;">GZ-MG840</div> <div style="border: 1px solid black; padding: 2px; margin-bottom: 5px;">GZ-MG680</div> <div style="border: 1px solid black; padding: 2px; margin-bottom: 5px;">GZ-MG645</div>  <b>HDMI OUTPUT</b> Sets the definition of the video output from the HDMI mini connector.	<b>AUTO 1:</b> The video is output in 576i, 576p, 1080i or 1080p. <b>AUTO 2:</b> The video is output in 576i, 576p or 1080i. <b>[576p]:</b> The video is output in 576i or 576p. <div style="background-color: black; color: white; padding: 2px; margin-top: 10px;"><b>NOTE</b></div> When the camcorder is in the recording mode, the HDMI mini connector outputs 576i or 576p regardless of the setting in the following cases: -  mode is selected. -  mode is selected and [SELECT ASPECT RATIO] is set to [4:3].
<div style="border: 1px solid black; padding: 2px; margin-bottom: 5px;">GZ-MG880</div> <div style="border: 1px solid black; padding: 2px; margin-bottom: 2px;">GZ-MG840</div> <div style="border: 1px solid black; padding: 2px; margin-bottom: 5px;">GZ-MG680</div> <div style="border: 1px solid black; padding: 2px; margin-bottom: 5px;">GZ-MG645</div>  <b>HDMI CONTROL</b> Selects whether you use the linked operations with the TV, when you connect the TV using the HDMI mini connector.	<b>OFF:</b> Turns off the linked operations. <b>[ON]:</b> Turns on the linked operations.
<div style="border: 1px solid black; padding: 2px; margin-bottom: 5px;">GZ-MG880</div> <div style="border: 1px solid black; padding: 2px; margin-bottom: 2px;">GZ-MG840</div> <div style="border: 1px solid black; padding: 2px; margin-bottom: 5px;">GZ-MG830</div> <div style="border: 1px solid black; padding: 2px; margin-bottom: 5px;">GZ-MG680</div> <div style="border: 1px solid black; padding: 2px; margin-bottom: 5px;">GZ-MG645</div>  <b>SWITCH TO ANALOG I/O</b> Switches input and output for the AV connector of the camcorder.	<b>[OUTPUT]:</b> Switches to output. <b>INPUT:</b> Switches to input. The  indicator lights up on the LCD monitor.

## Changing the Menu Settings (Continued)

Menus	Settings: [ ] = Factory-preset
 <b>MEDIA SETTINGS</b>	Select [MEDIA SETTINGS], then select sub-menus.
 <b>REC MEDIA FOR IMAGE</b> Sets the recording medium for still images.	[HDD] / SD
 <b>REC MEDIA FOR VIDEO</b> Sets the recording medium for video.	[HDD] / SD
 <b>FORMAT HDD</b> Ensures stable speeds and operation when accessing the HDD.	<b>[FILE]:</b> Initializes all files in the HDD. <b>FILE + MANAGEMENT NO:</b> Initializes all files and management numbers in the HDD. <b>NOTE</b> ● Be aware that all files and data including protected files will be erased by the formatting process.
 <b>FORMAT SD CARD</b> You have to format newly purchased microSD cards with this camcorder before using them. This will also ensure stable speeds and operation when accessing the microSD card.	<b>[FILE]:</b> Initializes all files in the microSD card. <b>FILE + MANAGEMENT NO:</b> Initializes all files and management numbers in the microSD card. <b>NOTE</b> ● Be aware that all files and data including protected files will be erased by the formatting process.
 <b>DELETE DATA ON HDD</b> When you dispose of the camcorder, perform this to make it difficult to recover data on the HDD.	<b>YES:</b> Performs this function. Select [OK] when completed. <b>[NO]:</b> Cancels this function. <b>NOTE</b> ● In addition to this operation, it is recommended that you use a commercially available data erasing software to eliminate the risk of data recovery.



# Troubleshooting

Before requesting service, consult the following chart. If the solutions indicated in the chart do not solve the problem, consult your nearest JVC dealer or JVC service center for instructions.

Refer also to the FAQ of new products on JVC's website.

## The following phenomena are not malfunctions.

- The camcorder heats up when it is used for a long time.
- The battery heats up during charging.
- When playing back a video, the image stops momentarily or the sound is interrupted at junctions between scenes.
- LCD monitor momentarily become red or black when sunlight is recorded.
- Black spots, or red, green, or blue spots appear on the LCD monitor.  
(The LCD monitor contains 99.99% effective pixels, but 0.01% of fewer pixels may be ineffective.)

Trouble		Action
Power	No power is supplied.	<ul style="list-style-type: none"><li>● Connect the AC adapter correctly.</li><li>● Recharge the battery pack.</li></ul>
	After the low temperature message is displayed, the power turns off when the camcorder warms up.	<ul style="list-style-type: none"><li>● When the camcorder has warmed up after being cold, the camcorder may switch itself off to check it is operating correctly. Turn on the camcorder again to start using it.</li></ul>
	<a href="#">GZ-MG880</a> <a href="#">GZ-MG840</a> <a href="#">GZ-MG680</a> <a href="#">GZ-MG645</a> The power was turned off accidentally.	<ul style="list-style-type: none"><li>● If you connect to a TV compatible with HDMI-CEC with an HDMI cable (optional) and turn off the power on the TV, the power on this camcorder also turns off. If you are not using HDMI-CEC, set [HDMI CONTROL] to [OFF].</li></ul>
Display	The remaining battery display is not correct.	<ul style="list-style-type: none"><li>● Fully charge the battery pack, run it down, and then recharge it again.</li><li>● If the camcorder is used for long periods of time in high or low temperatures, or if the battery pack is repeatedly charged, the amount of remaining battery may not be displayed correctly.</li></ul>
	The LCD monitor is difficult to see.	<ul style="list-style-type: none"><li>● The LCD monitor may be difficult to see if used in bright areas such as under direct sunlight.</li></ul>

# Troubleshooting (Continued)

Trouble	Action
<b>Recording cannot be performed.</b>	<ul style="list-style-type: none"> <li>Slide the mode switch to select the desired mode (👤 or 📷).</li> </ul>
<b>Recording stops by itself.</b>	<ul style="list-style-type: none"> <li>If the camcorder temperature increases, REC flashes in the LCD monitor and recording stops automatically to protect the HDD. Turn off the camcorder, wait for a while, and start recording again.</li> <li>Move away from a place where the camcorder is affected by excessive sound or vibration (such as a concert hall).</li> <li>A malfunction may occur in the HDD of the camcorder. In this case, record to a microSD card.</li> <li>Insert a commercially available microSD card, and set each of the [REC MEDIA FOR VIDEO] and [REC MEDIA FOR IMAGE] to [SD].</li> <li>Recording stops automatically after 12 hours of continuous recording.</li> </ul>
<b>The recorded subject is too dark.</b>	<ul style="list-style-type: none"> <li>Use backlight compensation.</li> <li>Set [GAIN UP] to [AGC] or [AUTO].</li> <li>Use [NIGHT] from scene select.</li> <li>Set the brightness to the [+] side.</li> </ul>
<b>The recorded subject is too bright.</b>	<ul style="list-style-type: none"> <li>Set the backlight compensation to [OFF] if it is being used.</li> <li>Set the brightness to the [-] side.</li> </ul>
<b>Digital zoom does not work.</b>	<p><b>GZ-MG880</b> <b>GZ-MG840</b> <b>GZ-MG830</b></p> <ul style="list-style-type: none"> <li>Change [ZOOM] to [76X/DIGITAL] or [800/DIGITAL].</li> </ul> <p><b>GZ-MG680</b> <b>GZ-MG645</b> <b>GZ-MG630</b></p> <ul style="list-style-type: none"> <li>Change [ZOOM] to [70X/DIGITAL] or [800X/DIGITAL].</li> <li>Digital zoom is not available in the still image recording mode.</li> </ul>
<b>The focus is not adjusted automatically.</b>	<ul style="list-style-type: none"> <li>Wipe the lens with lens cleaning cloth.</li> <li>If you are recording in a dark place or a subject that has no contrast between dark and light, adjust the focus manually.</li> </ul>
<b>The color looks strange. (Too bluish, too reddish, etc)</b>	<ul style="list-style-type: none"> <li>Set [WB] in [MANUAL SETTING] appropriately to the light source.</li> <li>Select [MWB] in [WB] while holding a sheet of plain white paper in front of the camcorder so that the white paper fills the screen. Keep touching <b>OK</b> until the 📷 indicator appears.</li> </ul>
<b>White balance setting cannot be activated.</b>	<ul style="list-style-type: none"> <li>This cannot be used if [SEPIA] or [MONOTONE] are selected as effects.</li> <li>Do not use [TWILIGHT] from scene select.</li> </ul>
<b>The continuous shooting speed is slow.</b>	<ul style="list-style-type: none"> <li>The continuous shooting speed will drop after continuous shots.</li> <li>Continuous shooting speed may drop depending on the recording media or under certain recording conditions.</li> </ul>
<b>Band of bright light appears on the LCD monitor.</b>	<ul style="list-style-type: none"> <li>This occurs when there is a bright light source near the camcorder. This is not a malfunction. Change the direction of the camcorder to prevent the light source comes into view.</li> </ul>

Trouble		Action
Playback	Sound or video are interrupted.	<ul style="list-style-type: none"> <li>• Sometimes playback is interrupted at the connecting section between two scenes. This is not a malfunction.</li> </ul>
	Cannot find a recorded video.	<ul style="list-style-type: none"> <li>• Select [PLAYBACK MPG FILE] then search the video on the index screen. (Video files that have damaged management information can be played back.)</li> <li>• Cancel group display and date search functions.</li> <li>• Change the setting in [REC MEDIA FOR VIDEO] or [REC MEDIA FOR IMAGE]. (Files on other media are not displayed.)</li> </ul>
	Some functions cannot be used when playing back a backup DVD through a DVD burner connected to the camcorder.	<ul style="list-style-type: none"> <li>• The following functions cannot be used for a backup DVD.               <ul style="list-style-type: none"> <li><b>When playing back video</b> <ul style="list-style-type: none"> <li>- Search index by date</li> <li>- Playback effects</li> </ul> </li> <li><b>When playing back still image</b> <ul style="list-style-type: none"> <li>- Playback effects</li> </ul> </li> </ul> </li> </ul>

# Troubleshooting (Continued)

	Action
<b>The camcorder operates slowly when switching between video mode and still image mode, or when switching the power on or off.</b>	<ul style="list-style-type: none"> <li>● If there are many files (such as video) in the camcorder, it takes time for the camcorder to respond. It is recommended that you copy all files from the camcorder onto your computer, and erase the files from the camcorder.</li> </ul>
<b>The lamp does not flash during battery pack charging.</b>	<ul style="list-style-type: none"> <li>● Check the remaining battery pack charge. (When the battery pack is fully charged, the lamp does not flash.)</li> <li>● When recharging in either a hot or cold environment, ensure that battery is being charged within the permitted temperature range. (If the battery pack is being recharged outside the permitted temperature range, recharging may stop to protect the battery pack.)</li> </ul>
<b>The remote control does not work.</b>	<ul style="list-style-type: none"> <li>● Replace the battery.</li> <li>● Set [REMOTE] to [ON].</li> <li>● The remote control may not operate outdoors or in places exposed to strong light.</li> </ul>
<div style="display: flex; align-items: center;"> <div style="writing-mode: vertical-rl; transform: rotate(180deg); font-weight: bold; margin-right: 5px;">Other problems</div> <div style="flex-grow: 1;"> <div style="border: 1px solid black; padding: 2px; margin-bottom: 2px;"> <span style="font-size: small;">GZ-MG880</span> <span style="font-size: small;">GZ-MG840</span> </div> <div style="border: 1px solid black; padding: 2px; margin-bottom: 2px;"> <span style="font-size: small;">GZ-MG680</span> <span style="font-size: small;">GZ-MG645</span> </div> <p><b>When connecting to the HDMI cable, the image or sound does not appear on the TV properly.</b></p> </div> </div>	<ul style="list-style-type: none"> <li>● When connecting to the HDMI cable, the image or sound may not appear on the TV properly depending on the TV connected. In such cases, perform the following operations.             <ol style="list-style-type: none"> <li>1) Disconnect the HDMI cable and connect it again.</li> <li>2) Turn off and on the camcorder again.</li> </ol> </li> </ul>
<div style="display: flex; align-items: center;"> <div style="writing-mode: vertical-rl; transform: rotate(180deg); font-weight: bold; margin-right: 5px;">Other problems</div> <div style="flex-grow: 1;"> <div style="border: 1px solid black; padding: 2px; margin-bottom: 2px;"> <span style="font-size: small;">GZ-MG880</span> <span style="font-size: small;">GZ-MG840</span> </div> <div style="border: 1px solid black; padding: 2px; margin-bottom: 2px;"> <span style="font-size: small;">GZ-MG680</span> <span style="font-size: small;">GZ-MG645</span> </div> <p><b>HDMI-CEC functions do not work properly, and the TV does not work in conjunction with the camcorder.</b></p> </div> </div>	<ul style="list-style-type: none"> <li>● TVs may operate differently depending on the specifications, even if they are HDMI-CEC compliant. Therefore, the HDMI-CEC functions of the camcorder cannot be guaranteed to operate in combination with all the TVs. In such cases, set [HDMI CONTROL] to [OFF].</li> </ul>
<div style="display: flex; align-items: center;"> <div style="writing-mode: vertical-rl; transform: rotate(180deg); font-weight: bold; margin-right: 5px;">Other problems</div> <div style="flex-grow: 1;"> <div style="border: 1px solid black; padding: 2px; margin-bottom: 2px;"> <span style="font-size: small;">GZ-MG880</span> <span style="font-size: small;">GZ-MG840</span> </div> <div style="border: 1px solid black; padding: 2px; margin-bottom: 2px;"> <span style="font-size: small;">GZ-MG680</span> <span style="font-size: small;">GZ-MG645</span> </div> <p><b>The language on the display changed.</b></p> </div> </div>	<ul style="list-style-type: none"> <li>● It may occur when you connect the camcorder to a TV with different language setting using an HDMI cable.</li> </ul>

## ■ If a malfunction occurs in the HDD

- ① Perform [FORMAT HDD]. (All data is deleted.)
- ② If this does not solve the problem, perform the disc check function from a PC after formatting.
- ③ If this does not solve the problem, contact the JVC customer service for repairs.

## ■ To reset the camcorder when it does not operate normally

- ① Close the LCD monitor and remove the power supply (battery pack or AC adapter) from the camcorder, then reattach it.
- ② Execute [FACTORY PRESET]. (⇨ p. 62)

# Warning Indications

Indication	Action
<b>SET DATE/TIME!</b>	<ul style="list-style-type: none"> <li>● Set the clock. If the message still appears after setting the clock, the battery for the clock has been depleted. Consult your nearest JVC dealer.</li> </ul>
<b>COMMUNICATING ERROR</b>	<ul style="list-style-type: none"> <li>● Be sure to use JVC battery packs.</li> </ul>
<b>CANNOT USE IN VIDEO MODE</b>	<ul style="list-style-type: none"> <li>● Set [REC MEDIA FOR VIDEO] to [HDD].</li> <li>● Replace the microSD card.</li> </ul>
<b>NOT FORMATTED</b>	<ul style="list-style-type: none"> <li>● Select [OK] and select [YES] to perform formatting.</li> </ul>
<b>FORMAT ERROR!</b>	<ul style="list-style-type: none"> <li>● Check the operating procedure, and perform once again.</li> <li>● Turn off the camcorder, and turn it on again.</li> </ul>
<b>DATA DELETION ERROR</b>	
<b>HDD ERROR!</b>	<ul style="list-style-type: none"> <li>● Perform formatting. (All data is deleted.)</li> <li>● Turn off the camcorder, and turn it on again.</li> </ul>
<b>MEMORY CARD ERROR!</b>	<ul style="list-style-type: none"> <li>● Perform formatting. (All data is deleted.)</li> <li>● Remove and re-insert the microSD card. (MultiMediaCard cannot be used.)</li> <li>● Remove any dirt from the microSD card terminals.</li> <li>● Insert the microSD card before switching the power on.</li> <li>● Turn off the camcorder, and turn it on again.</li> </ul>
<b>CANNOT TAKE MORE STILL IMAGES AT THE MOMENT</b>	<ul style="list-style-type: none"> <li>● Stop video recording, and then record a still image. (If a microSD card is removed or inserted during video recording, a still image cannot be recorded.)</li> </ul>
<b>DROP DETECTION WORKED AND THE POWER IS TURNED OFF</b>	<ul style="list-style-type: none"> <li>● Set [REC MEDIA FOR VIDEO] to [SD], then record to a microSD card.</li> <li>● Turn off the camcorder and turn it on again.</li> <li>● Prevent the camcorder from vibration and shock.</li> </ul>
<b>RECORDING CANCELLED</b>	
<b>RECORDING FAILURE</b>	<p><b>microSD card:</b></p> <ul style="list-style-type: none"> <li>● Remove and re-insert the microSD card. (MultiMediaCard cannot be used.)</li> <li>● Remove any dirt from the microSD card terminals.</li> <li>● Insert the microSD card before switching the power on.</li> </ul>
<b>PLAYBACK FAILED</b>	<p><b>HDD:</b></p> <ul style="list-style-type: none"> <li>● Do not allow the camcorder to be subject to impact/vibrations.</li> </ul>

## Warning Indications (Continued)

Indication	Action
<b>VIDEO MANAGEMENT FILE IS DAMAGED, RECOVERY IS REQUIRED TO RECORD/PLAYBACK, RECOVER?</b>	<ul style="list-style-type: none"> <li>• Select [OK] to restore.</li> </ul>
<b>UNSUPPORTED FILE!</b>	<ul style="list-style-type: none"> <li>• Use files recorded with the camcorder. (Files recorded with other device may not be played back.)</li> </ul>
<b>THIS FILE IS PROTECTED</b>	<ul style="list-style-type: none"> <li>• Switch off the [PROTECT/CANCEL] function in the MENU.</li> </ul>
<b>INSUFFICIENT SPACE</b>	<ul style="list-style-type: none"> <li>• Delete files. Move files to a PC or other device.</li> <li>• Replace the microSD card with a new one.</li> </ul>
<b>NUMBER OF FOLDERS OVERFLOW</b>	<ul style="list-style-type: none"> <li>• Replace the backup destination with another disc.</li> </ul>
<b>UPPER LIMIT OF RECORDABLE NUMBER OF FOLDERS/ FILES HAS BEEN REACHED</b>	<ul style="list-style-type: none"> <li>• Move the files or folder to a PC or other device, and then format the HDD of the camcorder or the microSD card.</li> <li>• Select [FILE + MANAGEMENT NO] in [FORMAT HDD] or [FORMAT SD CARD].</li> </ul>
<b>SCENE QUANTITY LIMIT EXCEEDED</b>	
<b>PLAYLIST QUANTITY EXCEEDS LIMIT</b>	<ul style="list-style-type: none"> <li>• When creating a DVD, reduce the number of playlists to be saved.</li> <li>• Reduce the number of the playlist to 99 files or less.</li> </ul>
<b>NO REGISTERED SCENES IN PLAYLIST SOME OF SCENES MAY NOT BE PLAYED BACK</b>	<ul style="list-style-type: none"> <li>• Delete the playlist, and then create a new one.</li> </ul>
<b>POWER IS OFF, OR USB DEVICE IS UNSUPPORTED</b>	<ul style="list-style-type: none"> <li>• Turn on the power of the connected USB device.</li> <li>• Connect the AC adapter to the DVD burner.</li> </ul>

Indication	Action
<b>DVD-RW DISC HAS BEEN ALREADY USED</b>	<ul style="list-style-type: none"> <li>● Replace the disc of the DVD burner with another disc. (A DVD-RW disc can be initialized.)</li> </ul>
<b>FINALIZATION FAILED</b>	<ul style="list-style-type: none"> <li>● Replace the disc of the DVD burner with another disc.</li> </ul>
<b>NO FILES</b>	<ul style="list-style-type: none"> <li>● Slide the mode switch to select the desired mode (👤 or 📷).</li> </ul>

## Cleaning

Before cleaning, turn off the camcorder and remove the battery pack and AC adapter.

### ■ To clean the camcorder

Wipe the camcorder gently with a soft cloth. If the camcorder is particularly dirty, dip the cloth into diluted mild soap and wring it out well. After wiping with the wet cloth, wipe again with a dry cloth.

### ■ To clean the LCD monitor

Wipe the LCD monitor gently with a soft cloth. Be careful not to damage the LCD monitor.

### ■ To clean the lens

Wipe the lens gently with lens cleaning cloth.

### NOTE

- Avoid using strong cleaning agents such as benzine or alcohol.
- Mold may form if the lens is left dirty.
- When using a cleaner or chemically treated cloth, refer to the cautions for each product.

# Specifications

## ■ General

### Power supply

- DC 11 V (Using AC adapter)
- DC 7.2 V (Using battery pack)

### Power consumption

**GZ-MG880** **GZ-MG840** **GZ-MG830**

Approx. 2.5 W\*

**GZ-MG680** **GZ-MG645** **GZ-MG630**

Approx. 2.3 W\*

\* When the LED light is off and the monitor backlight is set to [STANDARD] mode.

### Dimensions (W x H x D)

53 mm x 68 mm x 113 mm

### Weight

- Approx. 305 g
- Approx. 350 g (incl. battery pack)

### Operating temperature

0°C to 40°C

### Storage temperature

-20°C to 50°C

### Operating humidity

35% to 80%

## ■ Camera/LCD monitor

### Pickup

**GZ-MG880** **GZ-MG840** **GZ-MG830**

1/6" (1,070,000 pixels) CCD

**GZ-MG680** **GZ-MG645** **GZ-MG630**

1/6" (800,000 pixels) CCD

### Lens

**GZ-MG880** **GZ-MG840** **GZ-MG830**

Video: F 1.8 to 4.5, f = 2.5 mm to 80 mm,

32:1 power zoom lens

Still image: F 1.9 to 4.5, f = 2.9 mm to 80 mm,

27:1 power zoom lens

**GZ-MG680** **GZ-MG645** **GZ-MG630**

F 1.8 to 4.0, f = 2.2 mm to 77.0 mm,

35:1 power zoom lens

### Filter diameter

ø30.5 mm

### LCD monitor

2.7" diagonally measured,

LCD panel/TFT active matrix system

### LED Light

Within 1.5 m (recommended shooting distance)

## ■ Connectors

### AV input/output

Video input\*: 0.8 V (p-p) to 1.2 V (p-p), 75 Ω

Video output: 1.0 V (p-p), 75 Ω

Audio input\*: 300 mV (rms), 50 kΩ

Audio output: 300 mV (rms), 1 kΩ

\* **GZ-MG880** **GZ-MG840** **GZ-MG830** **GZ-MG680**

**GZ-MG645** only

### HDMI

**GZ-MG880** **GZ-MG840** **GZ-MG680** **GZ-MG645**

HDMI Mini Connector

## USB

- Mini USB type A and type B,
- USB 2.0 compliant

## ■ AC Adapter

### Power requirement

AC 110 V to 240 V~, 50 Hz/60 Hz

### Output

DC 11 V —, 1 A

## ■ Remote Control

### Power supply

DC 3 V

### Battery life

Approx. 1 year  
(depending on the frequency of use)

### Operating distance

Within 5 m

### Operating temperature

0°C to 40°C

### Dimensions (W x H x D)

42 mm x 14.5 mm x 91 mm

### Weight

Approx. 30 g (incl. battery)

## ■ Still image

### Format

JPEG

### Image size

**GZ-MG880** **GZ-MG840** **GZ-MG830**

1152x864 / 640x480

**GZ-MG680** **GZ-MG645** **GZ-MG630**

832x624

### Image quality

FINE / STANDARD

## ■ Video

### Signal format

PAL standard

### Recording/Playback format

Video: MPEG-2

Audio: Dolby Digital (2ch)

### Recording mode (video)

ULTRA FINE: 720 x 576 pixels, 8.5 Mbps (VBR)

FINE: 720 x 576 pixels, 5.5 Mbps (VBR)

NORMAL: 720 x 576 pixels, 4.2 Mbps (VBR)

ECONOMY: 352 x 288 pixels, 1.5 Mbps (VBR)

### Recording mode (audio)

ULTRA FINE: 48 kHz, 384 kbps

FINE: 48 kHz, 384 kbps

NORMAL: 48 kHz, 256 kbps

ECONOMY: 48 kHz, 128 kbps

Design and specifications subject to change without notice.



h: hour/m: minute

**Approximate recordable time (for video)**

Recording medium		HDD		microSD Card	
		GZ-MG840 GZ-MG830 GZ-MG645 GZ-MG630 60 GB	GZ-MG880 GZ-MG680 120 GB	4 GB	8 GB
Quality					
ULTRA FINE		14 h 20 m	28 h 40 m	57 m	1 h 54 m
FINE		21 h 20 m	42 h 40 m	1 h 25 m	2 h 50 m
NORMAL		28 h 10 m	56 h 20 m	1 h 53 m	3 h 46 m
ECONOMY		75 h 00 m	150 h 00 m	4 h 58 m	9 h 56 m

**Approximate number of images (for still image)**

The HDD can record up to 9999 still images in either mode.

GZ-MG880 | GZ-MG840 | GZ-MG830

Recording medium		microSD Card					
		256 MB	512 MB	1 GB	2 GB	4 GB	8 GB
4:3	1152 x 864 / FINE	520	1060	2150	4065	8255	9999
	1152 x 864 / STANDARD	795	1620	3280	6100	9999	9999
	640 x 480 / FINE	1515	3080	6240	9999	9999	9999
	640 x 480 / STANDARD	2170	4405	8920	9999	9999	9999

GZ-MG680 | GZ-MG645 | GZ-MG630

Recording medium		microSD Card					
		256 MB	512 MB	1 GB	2 GB	4 GB	8 GB
4:3	832 x 624 / FINE	1010	2050	4160	7625	9999	9999
	832 x 624 / STANDARD	1515	3080	6240	9999	9999	9999

h: hour/m: minute

**Required charging/recording time (approx.)**

Battery pack	Charging time	Recording time	
		GZ-MG880 GZ-MG840 GZ-MG830	GZ-MG680 GZ-MG645 GZ-MG630
BN-VF808U (Provided)	1 h 50 m	1 h 55 m*	2 h 5 m*
BN-VF815U	2 h 40 m	3 h 55 m*	4 h 15 m*
BN-VF823U	3 h 40 m	5 h 55 m*	6 h 25 m*

\* When the LED light is off and the monitor backlight is set to [STANDARD] mode.

# Cautions

## Battery Pack

The supplied battery pack is a lithium-ion battery. Before using the supplied battery pack or an optional battery pack, be sure to read the following cautions:

### Terminals

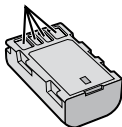

- **To avoid hazards**

- ... **do not** burn.

- ... **do not** short-circuit the terminals. Keep it away from metallic objects when not in use. When transporting, make sure the provided battery cap is attached to the battery. If the battery cap is misplaced, carry the battery in a plastic bag.

- ... **do not** modify or disassemble.

- ... **do not** expose the battery to temperatures exceeding 60°C, as this may cause the battery to overheat, explode or catch fire.

- ... use only specified chargers.

- **To prevent damage and prolong service life**

- ... do not subject to unnecessary shock.

- ... charge within the temperature range of 10°C to 35°C. Cooler temperatures require longer charging time, or in some cases stop charging at all. Warmer temperatures prevent complete charging, or in some cases stop charging at all.

- ... store in a cool, dry place. Extended exposure to high temperatures will increase natural discharge and shorten service life.

- ... fully charge and then fully discharge the battery every 6 months when storing the battery pack over a long period of time.

- ... remove from charger or powered unit when not in use, as some machines use current even when switched off.

## Recording Medium

- **Be sure to follow the guidelines below to prevent corruption or damage to your recorded data.**

- Do not bend or drop the recording medium, or subject it to strong pressure, jolts or vibrations.

- Do not splash the recording medium with water.

- Do not use, replace, or store the recording medium in locations that are exposed to strong static electricity or electrical noise.

- Do not turn off the camcorder power or remove the battery or AC adapter during shooting, playback, or when otherwise accessing the recording medium.

- Do not bring the recording medium near objects that have a strong magnetic field or that emit strong electromagnetic waves.

- Do not store the recording medium in locations with high temperature or high humidity.

- Do not touch the metal parts.

- When formatting or erasing data using the camcorder, only the file administration information is changed. The data is not completely erased from the hard disk. If you want to completely erase all of the data, we recommend either using commercially available software that is specially designed for that purpose, or by physically destroying the camcorder with a hammer etc.

## Hard Disk

- Do not use the unit where it is subject to vibrations or loud sounds.

- If you move the unit suddenly, the drop detection function may operate and the power may be turned off.

## LCD Monitor

- **To prevent damage to the LCD monitor, DO NOT**

- ... push it strongly or apply any shocks.

- ... place the camcorder with LCD monitor on the bottom.

- **To prolong service life**

- ... avoid rubbing it with coarse cloth.

## Main Unit

### ● For safety, DO NOT

- ... open the camcorder's chassis.
- ... disassemble or modify the unit.
- ... allow inflammables, water or metallic objects to enter the unit.
- ... remove the battery pack or disconnect the power supply while the power is on.
- ... leave the battery pack attached when the camcorder is not in use.
- ... place naked flame sources, such as lighted candles, on the apparatus.
- ... expose the apparatus to dripping or splashing.
- ... leave dust or metal objects adhered to the power plug or an AC wall outlet.
- ... insert any objects in the camcorder.

### ● Avoid using the unit

- ... in places subject to excessive humidity or dust.
- ... in places subject to soot or steam such as near a cooking stove.
- ... in places subject to excessive shock or vibration.
- ... near a television set.
- ... near appliances generating strong magnetic or electric fields (speakers, broadcasting antennas, etc.).
- ... in places subject to extremely high (over 40°C) or extremely low (under 0°C) temperatures.
- ... in places where air pressure is low (more than 3000 m above the sea level).

### ● DO NOT leave the unit

- ... in places of over 50°C.
- ... in places where humidity is extremely low (below 35%) or extremely high (above 80%).
- ... in direct sunlight.
- ... in a closed car in summer.
- ... near a heater.
- ... in high places such as on a TV. Leaving the unit in high places while a cable is connected may result in a malfunction if the cable is caught and the unit falls onto the floor.

### ● To protect the unit, DO NOT

- ... allow it to become wet.
- ... drop the unit or strike it against hard objects.
- ... subject it to shock or excessive vibration during transportation.
- ... keep the lens directed at extremely bright objects for long periods.
- ... expose the lens to direct sunlight.
- ... swing it excessively when using the hand strap.
- ... swing the soft camcorder case excessively when the camcorder is inside it.
- ... place the camcorder in dusty or sandy areas, such as on a beach.

### ● To prevent the unit from dropping,

- Fasten the grip belt securely.
  - When using the camcorder with a tripod, attach the camcorder to the tripod securely.
- If the camcorder drops, you may be injured and the camcorder may be damaged.  
When a child uses the unit, there must be parental guidance.

# JVC Software License Agreement

## JVC SOFTWARE LICENSE AGREEMENT

### **IMPORTANT**

TO CUSTOMERS: PLEASE MAKE SURE TO READ THIS CAREFULLY BEFORE INSTALLING OR USING THE SOFTWARE PROGRAM NAMED "DIGITAL PHOTO NAVIGATOR" ("Program") ON YOUR PC. The right to use the Program is granted by Victor Company of Japan, Limited ("JVC") to You only on the condition that You agree to the following.

Should You not agree to the terms hereof, You may not install or use the Program. HOWEVER, INSTALLING OR USING THE PROGRAM INDICATES YOUR ACCEPTANCE OF THESE TERMS AND CONDITIONS.

### **1 COPYRIGHT; OWNERSHIP**

You acknowledge that all copyrights and other intellectual property rights in the Program are owned by JVC and its licensor, and remain vested in JVC and such licensor. The Program is protected under the copyright law of Japan and other countries, and related Conventions.

### **2 GRANT OF LICENSE**

- (1) Subject to the conditions of this Agreement, JVC grants to You a non-exclusive right to use the Program. You may install and use the Program on a HDD or other storage devices incorporated in Your PC.
- (2) You may make one (1) copy of the Program solely for your personal backup or archival purposes.

### **3 RESTRICTION ON THE PROGRAM**

- (1) You may not reverse engineer, decompile, disassemble, revise or modify the Program, except to the extent that expressly permitted by applicable law.
- (2) You may not copy or use the Program, in whole or in part, other than as expressly specified in this Agreement.
- (3) You have no right to grant a license to use the Program, and may not distribute, rent, lease or transfer the Program to any third party or otherwise let them use the Program.

### **4 LIMITED WARRANTY**

JVC warrants that any media in which the Program is embodied are free from any defects in materials and workmanship for a period of thirty (30) days from the date of Your purchasing any our products accompanying the Program. JVC's entire liability and your exclusive remedy in connection with the Program shall be replacement of such defective media. EXCEPT FOR THE EXPRESS WARRANTIES STATED HEREIN AND TO THE EXTENT PERMITTED BY APPLICABLE LAW, JVC AND ITS LICENSORS DISCLAIM ANY OTHER WARRANTIES, EITHER EXPRESS OR IMPLIED, INCLUDING BUT NOT LIMITED TO IMPLIED WARRANTIES OF MERCHANTABILITY AND FITNESS FOR A PARTICULAR PURPOSE IN REGARD TO THE PROGRAM AND THE ACCOMPANYING PRINTED MATERIALS. SHOULD THERE BE ANY PROBLEM ARISING FROM OR CAUSED BY THE PROGRAM, YOU SHOULD SETTLE ALL SUCH PROBLEM AT YOUR OWN COST AND EXPENSE.

### **5 LIMITED LIABILITY**

TO THE EXTENT PERMITTED BY APPLICABLE LAW, IN NO EVENT SHALL JVC AND ITS LICENSORS BE LIABLE FOR ANY INDIRECT, SPECIAL, INCIDENTAL OR CONSEQUENTIAL DAMAGES WHATSOEVER, REGARDLESS OF THE FORM OF ACTION WHETHER IN CONTRACT, TORT OR OTHERWISE ARISING OUT OF OR IN CONNECTION WITH THE USE OF OR INABILITY TO USE THE PROGRAM, EVEN IF JVC HAS BEEN ADVISED OF THE POSSIBILITY OF SUCH DAMAGES. YOU WILL INDEMNIFY AND HOLD HARMLESS JVC FROM ANY LOSS, LIABILITY OR COST ARISING OUT OF OR IN ANY WAY CONNECTED TO CLAIMS FROM ANY THIRD PARTY RELATING TO THE USE OF THE PROGRAM.

## 6 TERM

This Agreement will become effective on the date when You install and use the Program on Your machine, and continue to be in effect until the termination under the following provision. Should You breach any provision of this Agreement, JVC may terminate this Agreement without giving any notice to You. In this event, JVC may claim against You for any damages caused by Your breach. Should this Agreement be terminated, You must immediately destroy the Program stored in Your machine (including the erasing from any memory in Your PC), and no longer own such Program.

## 7 EXPORT CONTROL

You agree that You will not ship, transfer or export the Program or underlying information and technology to any countries to which Japan and other relevant countries have initiated an embargo on such goods.

## 8 U.S. GOVERNMENT USER

If You are an agency of the United States of America (the "Government"), You acknowledge JVC's representation that the Program is a "Commercial Item" as defined in Federal Acquisition Regulation (FAR) part 2.101 (g) consisting unpublished "Commercial Computer Software" as those items are used at FAR part 12.212 and is only licensed to You with the same use rights JVC grants all commercial end users pursuant to the terms of this Agreement.

## 9 GENERAL

- (1) No modification, change, addition, deletion or other alternation of or to this Agreement will be valid unless reduced to writing and signed by an authorized representative of JVC.
- (2) If any part of this Agreement is held invalid by or in conflict with any law having jurisdiction over this Agreement, the remaining provisions will remain in full force and effect.
- (3) This Agreement shall be governed by and interpreted under the laws of Japan. The Tokyo District Court has jurisdiction over all disputes which may arise with respect to the execution, interpretation and performance of this Agreement.

Victor Company of Japan, Limited

## NOTE

If You acquired the Program in Germany, the provisions of Sections 4 (Limited Warranty) and 5 (Limited Liability) provided above will be replaced with those of the German version of this Agreement.

## CAUTION:

- Operate this equipment according to the operating procedures described in this manual.
- Use only the provided CD-ROM. Never use any other CD-ROM to run this software.
- Do not attempt to modify this software.
- Changes or modifications not approved by JVC could void user's authority to operate the equipment.

## How to handle a CD-ROM

- Take care not to soil or scratch the mirror surface (opposite to the printed surface). Do not write anything or put a sticker on either the front or back surface. If the CD-ROM gets dirty, gently wipe it with a soft cloth outward from the center hole.
- Do not use conventional disc cleaners or cleaning spray.
- Do not bend the CD-ROM or touch its mirror surface.
- Do not store your CD-ROM in a dusty, hot or humid environment. Keep it away from direct sunlight.

**You can find the latest information (in English) on the provided software program at our world wide web server at <http://www.jvc-victor.co.jp/english/global-e.html>**





# Terms

<b>A</b>	AC Adapter .....	16	<b>M</b>	Manual Recording .....	28
	Adjust Brightness .....	29		Menu Settings .....	59
	Analog Input (Switch to Analog I/O) .....	63		microSD Card .....	19
	Auto Power Off .....	61		Monitor Backlight .....	61
	AV Connection .....	31, 53, 54		Monitor Bright .....	61
<b>B</b>	Backlight Compensation .....	28		Moving Files .....	43
	Battery Pack .....	16, 74	<b>N</b>	Number of Images .....	73
<b>C</b>	CD-ROM .....	48	<b>O</b>	On-screen Recording Control .....	20
	Clock Adjust .....	16		On-screen Zoom Control .....	22
	Copying Files .....	43		Operation Sound .....	61
<b>D</b>	Date/Time Setting .....	3	<b>P</b>	Photometry Area .....	30
	Date Display Style .....	61		Picture Title .....	41
	Daylight Saving Time .....	16		Playlists .....	40
	Delete Data on HDD .....	64		Portable Media Player .....	55
	Deleting Files .....	34		Protecting Files .....	36
	Demo Mode .....	61	<b>Q</b>	Quick Restart .....	62
	Digest Playback .....	24, 47		Quick Review .....	20, 21
	Digital Image Stabilizer (DIS) .....	60	<b>R</b>	Recordable Time .....	73
	Display on TV .....	63		Record Button .....	62
	Drop Detection .....	62		Recording Medium .....	64, 74
	Dubbing Playback .....	53		Remaining Battery Power .....	22
	DVD Backup .....	44		Remaining Recording Time .....	23
	DVD Burner .....	44		Remote Control .....	11, 13, 62
<b>E</b>	Effect .....	30	<b>S</b>	Scene Select .....	29
	Event Registration .....	23		Select Aspect Ratio .....	60
	Export to Library Mode .....	55		Self-Timer .....	59
<b>F</b>	Factory Preset .....	62		Shutter Mode .....	59
	File Information .....	37		Shutter Speed .....	29
	File Search .....	26, 27		Speaker Volume .....	24
	Date Index Screen		<b>T</b>	Tele Macro .....	30
	Event Screen			Trimming Files .....	39
	Group Index Screen		<b>U</b>	Updating Software .....	62
	Finalize .....	44		Uploading Files .....	57
	Focus .....	29		USB Cable .....	44, 49
	Format HDD .....	64	<b>V</b>	Video Output .....	63
	Format SD Card .....	64		Video Quality .....	60
<b>G</b>	Gain Up .....	60		Viewing Files on TV .....	31
<b>H</b>	Hard Disk .....	74	<b>W</b>	White Balance (WB) .....	30
	HDMI .....	31, 33, 63		Wind Cut .....	60
<b>I</b>	Image Quality .....	60	<b>Y</b>	YouTube .....	57
	Image Size .....	59	<b>Z</b>	Zoom .....	22, 60
	iTunes .....	55			
<b>L</b>	Language Setting .....	17			
	LCD Monitor .....	14, 74			
	LED Light .....	22			

# JVC