



User's Manual

FlexScan® EV2430

Color LCD Monitor

Important

Please read this "User's Manual", and "PRECAUTIONS" (separate volume) carefully to familiarize yourself with safe and effective usage.

-
- Refer to the "Setup Guide" for information on the installation / connection of the monitor.
 - For the latest product information including the "User's Manual", refer to our web site :
<http://www.eizoglobal.com>
-

Location of Caution Statement

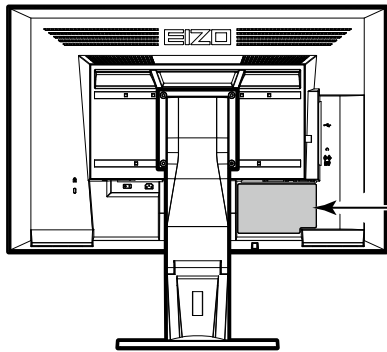

WARNING

RISK OF ELECTRIC SHOCK. DO NOT OPEN.

AVERTISSEMENT

RISQUE DE CHOC ELECTRIQUE. NE PAS OUVRIR.

WARNUNG

GEFAHR DES ELEKTRISCHEN SCHLAGES. RÜCKWAND NICHT ENTFERNEN.

警告

触电危険，请勿打开后盖。

警告

感電の恐れあり、カバーをあげないでください。

The equipment must be connected to a grounded main outlet.

L'appareil doit être relié à une prise avec terre.

Jordet stikkontakt skal benyttes når apparatet tilkobles datanett.

Apparaten skall anslutas till jordat nätuttag.

设备必须连接到接地式的电源插座。

電源コードのアースは必ず接地してください。

This product has been adjusted specifically for use in the region to which it was originally shipped. If operated outside this region, the product may not perform as stated in the specifications.

No part of this manual may be reproduced, stored in a retrieval system, or transmitted, in any form or by any means, electronic, mechanical, or otherwise, without the prior written permission of EIZO Corporation. EIZO Corporation is under no obligation to hold any submitted material or information confidential unless prior arrangements are made pursuant to EIZO Corporation's receipt of said information. Although every effort has been made to ensure that this manual provides up-to-date information, please note that EIZO monitor specifications are subject to change without notice.

Notice for this monitor

This product is suited to general purposes like creating documents, viewing multimedia content (Assuming usage of approximately 12 hours per day).

If using this product for the following kinds of applications, where an extremely high degree of reliability and safety is required, then measures should be in place to maintain safety while using this product.

- Transportation equipment (ships, aircraft, trains, and automobiles)
- Safety devices (Disaster prevention systems, security control systems, etc.)
- Life-critical devices (medical devices, such as life-support devices and operating room devices)
- Nuclear energy control devices (Nuclear energy control systems, security control systems of nuclear facilities, etc.)
- Major system communication devices (operation control systems of transportation systems, air traffic control systems, etc.)

This product has been adjusted specifically for use in the region to which it was originally shipped. If the product is used outside the region, it may not operate as specified in the specifications.

This product may not be covered by warranty for uses other than those described in this manual.

The specifications noted in this manual are only applicable when the following are used:

- Power cords provided with the product
- Signal cables specified by us

Only use optional products manufactured or specified by us with this product.

If you place this product on a lacquer-coated desk, the color may adhere to the bottom of the stand due to the composition of the rubber. Check the desk surface before use.

It takes about 30 minutes (under our measurement conditions) for the monitor display to stabilize. Please wait 30 minutes or more after the monitor power has been turned on, and then adjust the monitor.

Monitors should be set to a lower brightness to reduce changes in luminosity caused by long-term use and maintain a stable display.

When the screen image is changed after displaying the same image for extended periods of time, an afterimage may appear. Use the screen saver or power save function to avoid displaying the same image for extended periods of time. Depending on the image, an afterimage may appear even if it was displayed for a short period of time. To remove such a phenomenon, change the image or keep the power turned off for several hours.

If the monitor displays continuously over a long period of time, dark smudges or burn-in may appear. To maximize the life of the monitor, we recommend the monitor be turned off periodically.

Periodic cleaning is recommended to keep the monitor looking new and to prolong its operation lifetime (refer to [“Cleaning” \(page 4\)](#)).

The LCD panel is manufactured using high-precision technology. Although, missing pixels or lit pixels may appear on the LCD panel, this is not a malfunction. Percentage of effective dots: 99.9994 % or higher.

The backlight of the LCD panel has a fixed lifetime. Depending on the usage pattern, such as usage for long continuous periods, the lifespan of the backlight may run out sooner, requiring replacement. When the screen becomes dark or begins to flicker, please contact your local EIZO representative.

Do not press on the LCD panel or edge of the frame strongly, as this may result in display malfunctions, such as interference patterns, etc. If pressure is continuously applied to the LCD panel surface, the liquid crystal may deteriorate or the LCD panel may be damaged. (If the pressure marks remain on the panel, leave the monitor with a black or white screen. The symptom may disappear.)

Do not scratch or press on the LCD panel with any sharp objects, at this may result in damage to the LCD panel. Do not attempt to brush with tissues as this may scratch the panel.

When the monitor is cold and brought into a room or the room temperature goes up quickly, dew condensation may occur on the interior and exterior surfaces of the monitor. In that case, do not turn the monitor on. Instead wait until the dew condensation disappears, otherwise it may cause some damage to the monitor.

Cleaning

The stains on the cabinet and LCD panel surface can be removed by moistening part of a soft cloth with water.

Attention

- Chemicals such as alcohol and antiseptic solution may cause gloss variation, tarnishing, and fading of the cabinet or LCD panel, and also quality deterioration of the image.
- Never use thinner, benzine, wax, or abrasive cleaner as they may damage the cabinet or LCD panel surface.

Note

- It is recommended that ScreenCleaner (available as an option) be used to clean the cabinet and LCD panel surface.
-

To use the monitor comfortably

- An excessively dark or bright screen may affect your eyes. Adjust the brightness of the monitor according to the environmental conditions.
- Staring at the monitor for a long time tires your eyes. Take a 10-minute rest every hour.

CONTENTS

Notice for this monitor	3	Chapter 3 Setting Monitor	23
Cleaning	4	3-1. Adjusting Volume.....	23
To use the monitor comfortably	4	3-2. Selecting sound source while using the DisplayPort signal input.....	23
CONTENTS	5	3-3. Enabling / Disabling DDC/CI communication	23
Chapter 1 Introduction	7	3-4. Locking Operation Buttons	24
1-1. Features	7	3-5. Setting Orientation	24
1-2. Controls and Functions	8	3-6. Showing and hiding the EIZO logo	24
● Front	8	3-7. Changing Setting Menu Display Position	25
● Rear.....	9	3-8. Setting Language.....	25
1-3. Basic Operations and Functions	10	3-9. Resetting the Monitor to the Default Settings	26
● Basic operation of the Setting menu.....	10	● To reset the color adjustments.....	26
● Functions.....	11	● To reset “EcoView Sense Settings”	26
Chapter 2 Adjusting Screens	12	● To reset all adjustments to the default settings.....	26
2-1. Compatible Resolutions	12	Chapter 4 Power Saving Functions	27
● Analog Input (D-Sub)	12	4-1. Setting Power Saving	27
● Digital Input (DVI-D).....	12	● Monitor	27
● Digital Input (DisplayPort)	12	● Audio Output	28
2-2. Setting the Resolution	13	4-2. Setting Power Indicator.....	28
● Windows 10.....	13	4-3. Enabling / Disabling Automatic Brightness Adjustment	28
● Windows 8.1 / Windows 7	13	● Auto EcoView	28
● OS X Mountain Lion (10.8) or later.....	13	● EcoView Optimizer 2.....	29
● Mac OS X 10.7	13	4-4. Setting the power saving mode when a person leaves the monitor	29
2-3. Adjusting Color	14	4-5. Checking the power saving level	31
● To select the display mode (color mode)	14	4-6. Enabling / Disabling Auto Power-OFF.....	31
● To perform advanced adjustments	14	Chapter 5 Troubleshooting	32
● Adjustable settings in each mode	15	5-1. No picture	32
● To adjust brightness	15	5-2. Imaging problems (for both digital and analog).....	33
● To adjust contrast.....	16	5-3. Imaging problems (for digital only)	34
● To adjust color temperature	16	5-4. Imaging problems (for analog only)	34
● To adjust gamma	17	5-5. Other problems	35
● To adjust the color saturation.....	17		
● To adjust hue.....	18		
● To adjust gain	18		
2-4. Screen Adjustment	19		
● Digital Signal Input	19		
● Analog Signal Input.....	19		
2-5. Screen Size Changing	22		
● Screen Size Changing	22		
● To adjust brightness of non-display area	22		

Chapter 6 Reference	36
6-1. Attaching the Optional Arm.....	36
6-2. Detaching/Attaching Stand Base.....	37
6-3. Attaching/Detaching Cable Holder	40
6-4. Connecting Multiple PCs	42
● To switch among input signals	42
● To set input signal selection.....	43
6-5. Using the USB Hub Function.....	43
● Connection Procedure (Setup of USB Function).....	44
6-6. Displaying Monitor Information	44
6-7. Specifications	45
● Accessories.....	46
Appendix.....	47
Trademark	47
License	47
ENERGY STAR.....	47
FCC Declaration of Conformity	48

Chapter 1 Introduction

Thank you very much for choosing an EIZO color LCD monitor.

1-1. Features

- 24.1" wide format LCD
 - Supports a resolution of 1920 × 1200
 - Applicable to DisplayPort (applicable to 8 bit)^{*1}

The DisplayPort input receives both an image signal and an audio signal via a single DisplayPort cable.

^{*1} When transmitting an audio signal using the DisplayPort cable, the graphics board must be compatible with audio output (see "6-7. Specifications" (page 45)).
 - The Color Mode function allows the user to select the display mode optimum to the displayed image.
 - The Paper mode reproduces a printed paper effect on the monitor. In Paper mode, the amount of blue light emitted from the screen is reduced by changing the color tone and controlling the brightness.
See "To select the display mode (color mode)" (page 14).
 - Power saving function

Suppressing the power consumption^{*2} reduces the carbon dioxide emissions. This product is equipped with power saving function.

 - 0 W power consumption when the main power is off
Equipped with main power switch.
When the monitor is not required, the power supply can be shut off using the main power switch.
 - Auto EcoView
The ambient light sensor on the front side of the monitor detects the environmental brightness to adjust the screen brightness automatically and comfortably.
See "Auto EcoView" (page 28).
 - EcoView Optimizer 2
The monitor automatically adjusts the screen brightness according to the white level of the input signal. This function can reduce the power consumption while maintaining the brightness specified by the input signal.
See "EcoView Optimizer 2" (page 29).
 - EcoView Sense
The sensor on the front side of the monitor detects the movement of a person. When a person moves away from the monitor, the monitor shifts to the power saving mode automatically and does not display the images on the screen. Therefore, the function reduces the power consumption. The sensitivity and time until the power saving mode is activated can be set according to the monitor usage environment and movement of the user.
See "4-4. Setting the power saving mode when a person leaves the monitor" (page 29).
- ^{*2} Reference values:
Maximum power consumption: 36 W (Brightness Max., when a USB device is connected, speaker working, at default settings)
Standard power consumption: 12 W (Brightness 120 cd/m², when no USB device is connected, speaker not working, at default settings)
- Supports portrait and landscape formats
 - Displays HDCP (High-bandwidth Digital Protection) protected contents.

Note

- This monitor supports the portrait display. This function allows you to change the orientation of the Setting menu when using the monitor screen in vertical display position (see "3-5. Setting Orientation" (page 24)).
 - When using the monitor screen in a portrait position, the graphics board supporting portrait display is required. When placing the monitor in a portrait position, the settings of your graphics board need to be changed. Refer to the User's Manual of the graphics board for details.
-

1-2. Controls and Functions

● Front

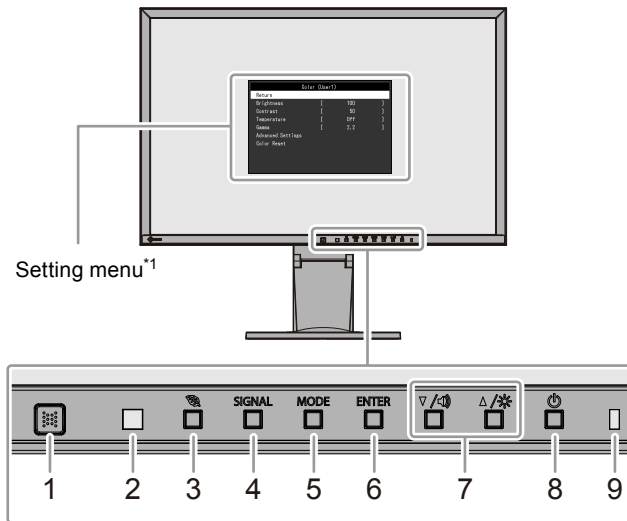

1. EcoView Sense sensor	Detects the movement of a person in front of the monitor (EcoView Sense function (page 29)).
2. Ambient light sensor	Detects ambient brightness (Auto EcoView function (page 28)).
3. button	Displays the setting menu of the power saving function (Auto EcoView (page 28) and EcoView Optimizer 2 (page 29) and EcoView Sense (page 29)).
4. SIGNAL button	Switches input signals for display (page 42).
5. MODE button	Switches the color mode (page 14).
6. ENTER button	Displays the Setting menu, determines an item on the menu screen, and saves values adjusted (page 10).
7. button ^{*2}	<ul style="list-style-type: none"> Provides the menu selection as well as the adjustment and setting of a function. button: Displays the volume adjustment menu (page 23). button: Displays the Brightness adjustment menu (page 15).
8. button	Turns the power on or off.
9. Power indicator	Indicates the monitor's operation status. White: Operating Orange: Power saving mode OFF: Main power / Power off

*1 See “1-3. Basic Operations and Functions” ([page 10](#)) for how to use.

*2 In this User's Manual, the button may be hereafter simply displayed as , and the button as .

● Rear

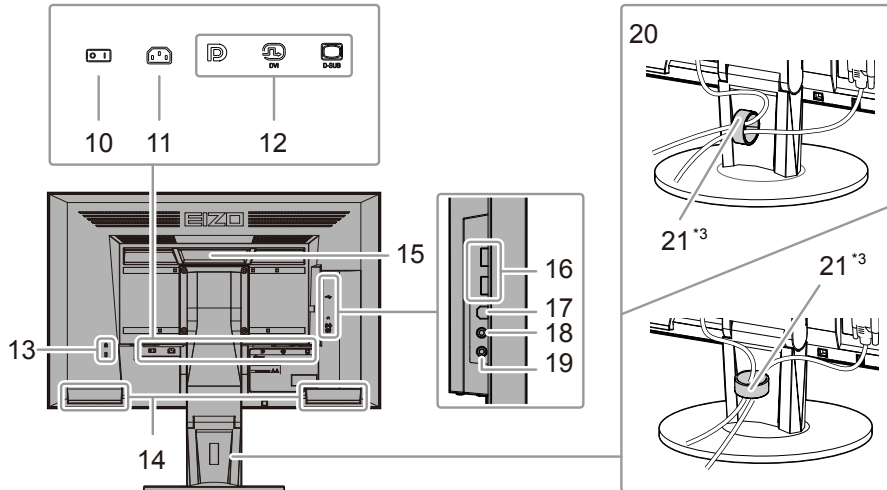

10. Main power switch	Turns the main power on () or off (○).
11. Power connector	Connects the power cord.
12. Input signal connector	Left: DisplayPort connector / Center: DVI-D connector / Right: D-Sub mini15-pin connector
13. Security lock slot	Complies with Kensington's MicroSaver security system.
14. Speaker	Outputs audio.
15. Handle	Handle used for transportation
	<p>Attention</p> <ul style="list-style-type: none"> Firmly grasp and hold the monitor by the bottom while grabbing the handle, and carefully convey the monitor so as not to drop it.
16. USB downstream port	Connects a peripheral USB device.
17. USB upstream port	Connects the USB cable for using the USB Hub function (page 43).
18. Headphone jack	Connects the headphones.
19. Analog audio input connector	Outputs external audio from the monitor.
20. Stand^{*4}	Adjusts the height and angle (tilt and swivel) of the monitor.
21. Cable holder	Covers the monitor cables.

*3 See "6-3. Attaching/Detaching Cable Holder" ([page 40](#)) for how to attach the cable holder.

*4 An optional arm (or an optional stand) can be attached by removing the stand (see "6-1. Attaching the Optional Arm" ([page 36](#))).

1-3. Basic Operations and Functions

● Basic operation of the Setting menu

1. Displaying the Setting menu

1. Press ENTER. The Setting menu appears.

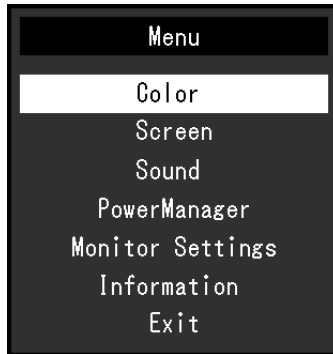

2. Adjusting / Setting

1. Choose a menu to adjust / set with ▼,▲, and then press ENTER. The Sub menu appears.

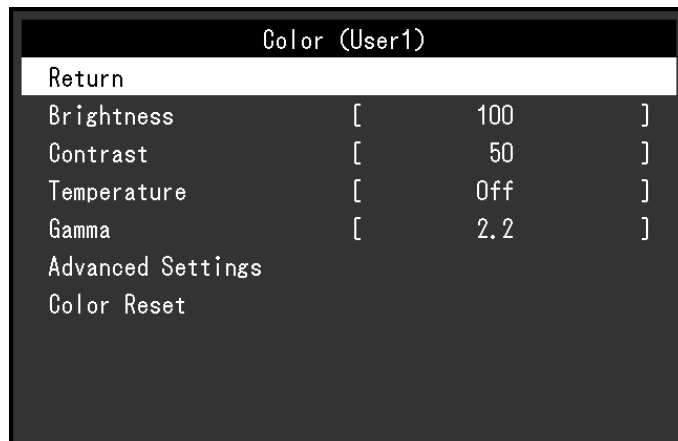

2. Choose an item to adjust / set with ▼,▲, and then press ENTER. The adjustment / setting menu appears.



3. Adjust / set the selected item with ▼,▲, and then press ENTER.

3. Exiting

1. Choose "Return" from the Sub menu and press ENTER. The Setting menu appears.
2. Choose "Exit" from the Main menu and press ENTER. The Setting menu quits.

Note

- The Setting menu can also be exited by pressing ENTER twice quickly.
-

● Functions

The following table shows the Setting menu and setting items of each menu.

Main menu	Setting	Reference	
Color ^{*1}	Brightness	"2-3. Adjusting Color" (page 14)	
	Contrast		
	Temperature		
	Gamma		
	Advanced Settings		Saturation
			Hue
	Gain		
	Color Reset	"To reset the color adjustments" (page 26)	
Screen	Screen Size	"Screen Size Changing" (page 22)	
	Smoothing	"2-4. Screen Adjustment" (page 19)	
	Analog Adjustment ^{*2}		Auto Screen Adjust
			Auto Range Adjust
			Clock
			Phase
			Hor.Position
Ver.Position			
Sound	Source	"3-2. Selecting sound source while using the DisplayPort signal input" (page 23)	
	Power Save	"Audio Output" (page 28)	
PowerManager	Power Save	"4-1. Setting Power Saving" (page 27)	
	Eco Timer	"4-6. Enabling / Disabling Auto Power-OFF" (page 31)	
Monitor Settings	Input Signal	"To set input signal selection" (page 43)	
	Power Indicator	"4-2. Setting Power Indicator" (page 28)	
	Language	"3-8. Setting Language" (page 25)	
	DDC/CI	"3-3. Enabling / Disabling DDC/CI communication" (page 23)	
	Border Intensity	"To adjust brightness of non-display area" (page 22)	
	Menu Settings	Orientation	"3-5. Setting Orientation" (page 24)
		Logo	"3-6. Showing and hiding the EIZO logo" (page 24)
		Menu Position	"3-7. Changing Setting Menu Display Position" (page 25)
	Reset	"To reset all adjustments to the default settings" (page 26)	
Information	"6-6. Displaying Monitor Information" (page 44)		

*1 The adjustment / settings available on the "Color" menu depend on the selected Color mode (see "Adjustable settings in each mode" (page 15)).

*2 These functions can be adjusted with analog input.

Chapter 2 Adjusting Screens

2-1. Compatible Resolutions

The monitor supports the following resolutions.

● Analog Input (D-Sub)

Resolution	Applicable Signals	Vertical Scan Frequency	Dot Clock
640 × 480	VGA	60 Hz	202.5 MHz (Max.)
800 × 600	VESA	60 Hz	
1024 × 768	VESA	60 Hz	
1280 × 720 ^{*1}	CEA-861	60 Hz	
1280 × 960	VESA	60 Hz	
1280 × 1024	VESA	60 Hz	
1600 × 1200	VESA	60 Hz	
1680 × 1050	VESA CVT, VESA CVT RB	60 Hz	
1920 × 1200 ^{*2}	VESA CVT, VESA CVT RB	60 Hz	

● Digital Input (DVI-D)

Resolution	Applicable Signals	Vertical Scan Frequency	Dot Clock
640 × 480	VGA	60 Hz	162 MHz (Max.)
800 × 600	VESA	60 Hz	
1024 × 768	VESA	60 Hz	
1280 × 720 ^{*1}	CEA-861	60 Hz	
1280 × 960	VESA	60 Hz	
1280 × 1024	VESA	60 Hz	
1600 × 1200	VESA	60 Hz	
1680 × 1050	VESA CVT, VESA CVT RB	60 Hz	
1920 × 1200 ^{*2}	VESA CVT RB	60 Hz	

● Digital Input (DisplayPort)

Resolution	Applicable Signals	Vertical Scan Frequency	Dot Clock
640 × 480	VGA, CEA-861	60 Hz	162 MHz (Max.)
720 × 480 (4:3)	CEA-861	60 Hz	
720 × 480 (16:9)	CEA-861	60 Hz	
800 × 600	VESA	60 Hz	
1024 × 768	VESA	60 Hz	
1280 × 720 ^{*1}	CEA-861	60 Hz	
1280 × 960	VESA	60 Hz	
1280 × 1024	VESA	60 Hz	
1600 × 1200	VESA	60 Hz	
1680 × 1050	VESA CVT, VESA CVT RB	60 Hz	
1920 × 1200 ^{*2}	VESA CVT RB	60 Hz	

*1 For this resolution, the “Screen Size” setting is “Full Screen” (see “2-5. Screen Size Changing” (page 22)).

*2 Recommended resolution

2-2. Setting the Resolution

When you connect the monitor to the PC and find that the resolution is improper, or when you want to change the resolution, follow the procedure below.

● Windows 10

1. Right-click the mouse anywhere on the desktop except on icons.
2. From the displayed menu, click “Display settings”.
3. If multiple monitors are connected to the computer, select the monitor.
4. Select the resolution from the “Resolution” pull-down menu.
5. When a confirmation screen appears, click “Keep changes”.

● Windows 8.1 / Windows 7

1. For Windows 8.1, click the “Desktop” tile on the Start Screen to display the desktop.
2. Right-click the mouse anywhere on the desktop except on icons.
3. From the displayed menu, click “Screen resolution”.
4. Select the monitor, and select the resolution from the “Resolution” pull-down menu.
5. Click the “OK” button.
6. When a confirmation dialog box is displayed, click “Keep changes”.

● OS X Mountain Lion (10.8) or later

1. Select “System Preferences” from the Apple menu.
2. When the “System Preferences” dialog box is displayed, click “Displays”. (For OS X Mountain Lion (10.8), click “Displays” for “Hardware”.)
3. On the displayed dialog box, select the “Display” tab, then choose “Scaled” for “Resolutions”.
4. The list of selectable resolutions is displayed. Select the desired resolution. If the desired resolution is not displayed in the list, hold down the Option key and select “Scaled”.
5. Your selection will be reflected immediately. When you are satisfied with the selected resolution, close the window.

● Mac OS X 10.7

1. Select “System Preferences” from the Apple menu.
2. When the “System Preferences” dialog box is displayed, click “Displays” for “Hardware”.
3. On the displayed dialog box, select the “Display” tab and select desired resolution in the “Resolutions” field.
4. Your selection will be reflected immediately. When you are satisfied with the selected resolution, close the window.

2-3. Adjusting Color

● To select the display mode (color mode)

This function allows easy selection of a desired mode according to monitor application.

Display Modes

Mode	Purpose
User1	Select this to define a desired set of parameter settings.
User2	
sRGB	Suitable for color matching with sRGB compatible peripherals.
Paper	Produces a printed paper effect. Suitable for displaying images from media such as books and documents.
Movie	Suitable for playing back animated images.

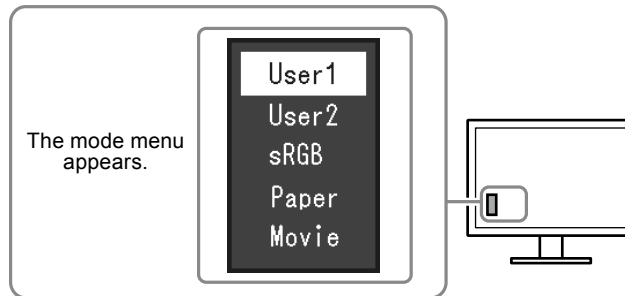

Procedure

1. Press MODE.
The mode menu appears at the bottom left of the screen.
2. The mode among the list is highlighted in turn each time MODE is pressed.
You can switch the mode with ▼ or ▲ while the mode menu is displayed.

Note

- The Setting menu and the Mode menu cannot be displayed at the same time.

● To perform advanced adjustments

The “Color” menu of the Setting menu allows you to set and save the independent color adjustment for each mode.

Attention

- It takes about 30 minutes for the monitor display to stabilize. Please wait 30 minutes or more after the monitor power has been turned on, and then adjust the monitor.
- Perform the range adjustment first when adjusting color for analog signals (see [“To adjust color gradation automatically” \(page 21\)](#)).
- The same image may be seen in different colors on multiple monitors due to their monitor-specific characteristics. Make fine color adjustment visually when matching colors on multiple monitors.

● Adjustable settings in each mode

The adjustable settings depend on the mode. (Non-adjustable or non-settable function cannot be selected.)

√: Adjustable -: Not adjustable

Function		Color Mode				
		User1	User2	sRGB	Paper	Movie
Brightness		√	√	√	√	√
Contrast		√	√	-	-	√
Temperature		√	√	-	√	√
Gamma		√	√	-	-	-
Advanced Settings	Saturation	√	√	-	-	√
	Hue	√	√	-	-	√
	Gain	√	√	-	-	-
Color Reset		√	√	√	√	√

● To adjust brightness

The screen brightness is adjusted by changing the brightness of the backlight (light source from the LCD back panel).

Adjustable range

0 to 100

Procedure

1. Press ▲/☼.
2. Use ▼ or ▲ for adjustment.
3. Press ENTER to exit.

Note

- If you feel that the image is too dark even if the brightness is set to 100, adjust the contrast.
 - Alternatively, you can use “Brightness” under “Color” in the Adjustment menu to adjust it.
 - To adjust the screen brightness automatically and comfortably, see [“4-3. Enabling / Disabling Automatic Brightness Adjustment” \(page 28\)](#).
-

● To adjust contrast

The brightness of the screen is adjusted by varying the video signal level.

Adjustable range

0 to 100

Procedure

1. Choose “Color” in the Setting menu, and press ENTER.
2. Choose “Contrast” in the “Color” menu, and press ENTER.
The “Contrast” menu appears.
3. Use ▼ or ▲ for adjustment.
4. Press ENTER to exit.

Note

- In the contrast of 50, every color gradation is displayed.
 - When adjusting the monitor, it is recommended to perform the brightness adjustment which may not lose the gradation characteristics, prior to the contrast adjustment.
 - Perform the contrast adjustment in the following cases.
 - When you feel the image is too dark even if the brightness is set to 100 (Set the contrast to higher than 50.)
-

● To adjust color temperature

Color temperature can be adjusted.

The color temperature is normally used to express the hue of “White” and / or “Black” by a numerical value.

The value is expressed in degrees “K” (Kelvin).

The screen becomes reddish at a low color temperature, and bluish at a high color temperature, like the flame temperature. A gain preset value is set for each color temperature setting value.

Adjustable range

Off, 4000 K-10000 K (specified by every 500 K unit, including 9300 K)

Procedure

1. Choose “Color” in the Setting menu, and press ENTER.
2. Choose “Temperature” in the “Color” menu, and press ENTER.
The “Temperature” menu appears.
3. Use ▼ or ▲ for adjustment.
4. Press ENTER to exit.

Note

- The value shown in “K” is available only as reference.
 - “Gain” allows you to perform more advanced adjustment (see [“To adjust gain” \(page 18\)](#)).
 - If you set to “Off”, the image is displayed in the preset color of the monitor (Gain: 100 for each RGB).
 - When gain is changed, the color temperature is changed to “Off”.
-

● To adjust gamma

Gamma can be adjusted. The brightness of the monitor varies depending on the input signal, however, the variation rate is not proportional to the input signal. To keep the balance between the input signal and the brightness of the monitor is called as “Gamma correction”.

Adjustable range

1.8, 2.0, 2.2

Procedure

1. Choose “Color” in the Setting menu, and press ENTER.
2. Choose “Gamma” in the “Color” menu, and press ENTER.
The “Gamma” menu appears.
3. Use ▼ or ▲ for adjustment.
4. Press ENTER to exit.

Note

- If “Paper” is selected for the color mode, “Paper” is displayed for the gamma value. The setting “Paper” is specially meant to get the displayed image look like it is printed on paper.
-

● To adjust the color saturation

This function allows you to adjust color saturation.

Adjustable range

-50 to 50

Procedure

1. Choose “Color” in the Setting menu, and press ENTER.
2. Choose “Advanced Settings” in the “Color” menu, and press ENTER.
3. Choose “Saturation” in the “Advanced Settings” menu, and press ENTER.
The “Saturation” menu appears.
4. Use ▼ or ▲ for adjustment.
5. Press ENTER to exit.

Attention

- Using this function may make some color gradations unavailable for display.
-

Note

- The minimum value (-50) changes the screen to monochrome.
-

● To adjust hue

This function allows you to adjust hue.

Adjustable range

-50 to 50

Procedure

1. Choose “Color” in the Setting menu, and press ENTER.
2. Choose “Advanced Settings” in the “Color” menu, and press ENTER.
3. Choose “Hue” in the “Advanced Settings” menu, and press ENTER.
The “Hue” menu appears.
4. Use ▼ or ▲ for adjustment.
5. Press ENTER to exit.

Attention

- Using this function may make some color gradations unavailable for display.
-

● To adjust gain

The brightness of each color component red, green, and blue is called “Gain”. You can change the hue of “white” by adjusting gain.

Adjustable range

0 to 100

Procedure

1. Choose “Color” in the Setting menu, and press ENTER.
2. Choose “Advanced Settings” in the “Color” menu, and press ENTER.
3. Choose “Gain” in the “Advanced Settings” menu, and press ENTER.
The “Gain” menu appears.
4. Adjust gain with ▼ or ▲ for each of red, green, and blue.
5. Press ENTER to exit.

Attention

- Using this function may make some color gradations unavailable for display.
-

Note

- The value of gain changes with that of color temperature.
 - When gain is changed, the color temperature is changed to “Off”.
-

2-4. Screen Adjustment

● Digital Signal Input

When digital signals are input, images are displayed correctly based on the preset data of the monitor, but if characters and / or lines appear blurred, go to [“To modify blurred characters / lines” \(page 21\)](#).

When performing more advanced adjustment, see [“2-3. Adjusting Color” \(page 14\)](#) and subsequent pages.

● Analog Signal Input

Attention

- It takes about 30 minutes for the monitor display to stabilize. Please wait 30 minutes or more after the monitor power has been turned on, and then adjust the monitor.
 - The Self Adjust (automatic screen adjustment) function does not work for the images under the resolution of 800 × 600 (SVGA).
 - The self adjustment (or automatic screen adjustment) function works correctly when an image is fully displayed over the Windows or Macintosh display area. They do not work properly in the cases below:
 - When an image is displayed only on a part of the screen (command prompt window, for example)
 - When a black background (wallpaper, etc.) is in use
- Also, these functions cannot work properly in some graphic boards.
-

The monitor screen adjustment is used to suppress flickering of the screen or adjust screen position and screen size correctly according to the PC to be used.

Note

- The Self Adjust function works when all of the following conditions are satisfied:
 - When a signal is input into the monitor for the first time or when a resolution or vertical / horizontal scan frequency not used before is set
-

If the screen is not displayed correctly even after performing the Self Adjust operation, adjust the screen according to the procedures on the following pages to use the monitor comfortably.

Setting Procedures

1. Adjust flickering, screen position, and size automatically.

Procedure

1. Choose “Screen” in the Setting menu, and press ENTER.
2. Choose “Analog Adjustment” in the “Screen” menu, and press ENTER.
3. Choose “Auto Screen Adjust” in the “Analog Adjustment” menu, and press ENTER.
4. Select “Yes” with ▼ or ▲, and press ENTER.

Flickering, screen position, and screen size are corrected by the auto-adjustment function.

If the screen is not displayed correctly even after performing the auto adjustment, perform adjustments according to the following procedure. If the screen is displayed correctly, go to [“3. Adjusting color gradation.” \(page 21\)](#).

2. Choose “Screen” from the Setting menu to perform advanced adjustments.

Adjust the clock, phase and position, in this order.

● To eliminate vertical bars

Procedure

1. Choose “Analog Adjustment” in the “Screen” menu, and press ENTER.
2. Choose “Clock” in the “Analog Adjustment” menu, and press ENTER.

The “Clock” menu appears.

3. Adjust the clock with ▼ or ▲ to eliminate vertical bars.
Press ▼ or ▲ slowly so as not to miss the adjustment point.
4. Press ENTER to exit.

When blurring, flickering or bars appear on the screen after adjustment, proceed to “To remove flickering or blurring”.

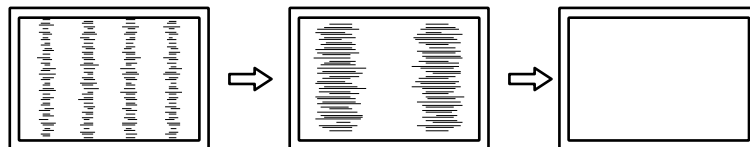

● To remove flickering or blurring

Procedure

1. Choose “Analog Adjustment” in the “Screen” menu, and press ENTER.
2. Choose “Phase” in the “Analog Adjustment” menu, and press ENTER.

The “Phase” menu appears.

3. Adjust the phase with ▼ or ▲ to minimize flickering or blurring.
4. Press ENTER to exit.

When vertical bars appear on the screen after adjustment, go back to “To eliminate vertical bars”.

(Clock → Phase → Position)

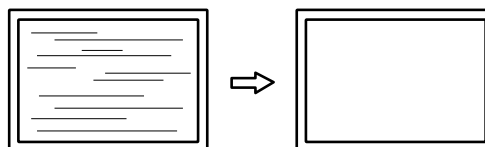

Attention

- Flickering or blurring may not be eliminated depending on your PC or graphics board.
-

● To correct the screen position

Note

- Since the number of pixels and the pixel positions are fixed on the LCD monitor, only one position is provided to display images correctly. The position adjustment is made to shift an image to the correct position.
-

Procedure

1. Choose “Analog Adjustment” in the “Screen” menu, and press ENTER.
2. Choose “Hor.Position” or “Ver.Position” from the “Analog Adjustment” menu, and press ENTER.
The “Hor. Position” or “Ver. Position” menu appears.
3. Adjust the position with ▼ or ▲.
4. Press ENTER to exit.

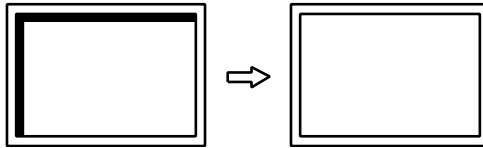

3. Adjusting color gradation.

● To adjust color gradation automatically

Every color gradation (0 to 255) can be displayed by adjusting the signal output level.

Procedure

1. Choose “Screen” in the Setting menu, and press ENTER.
2. Choose “Analog Adjustment” in the “Screen” menu, and press ENTER.
3. Choose “Auto Range Adjust” in the “Analog Adjustment” menu, and press ENTER.
4. Select “Yes” with ▼ or ▲, and press ENTER.

The output range is set automatically.

4. Modify blurred characters or lines.

● To modify blurred characters / lines

When an image is displayed with a resolution other than recommended, the characters or lines of the displayed image may blur.

Attention

- Smoothing setting may not be required depending on the display resolution. (You cannot choose the smoothing icon.)
-

Adjustable range

1 to 5

Procedure

1. Choose “Screen” in the Setting menu, and press ENTER.
2. Choose “Smoothing” in the “Screen” menu, and press ENTER.
The “Smoothing” menu appears.
3. Use ▼ or ▲ for adjustment.
4. Press ENTER to exit.

2-5. Screen Size Changing

● Screen Size Changing

The image with the resolution other than the recommended resolution is displayed in full screen automatically. You can change the screen size by using the “Screen Size” function.

Setting	Function
Full Screen	Displays an image in full screen. Images are distorted in some cases because the vertical rate is not equal to the horizontal rate.
Enlarged	Displays an image in full screen. In some cases, a blank horizontal or vertical border appears to equalize the vertical rate and the horizontal rate.

Example: Image size 1024×768

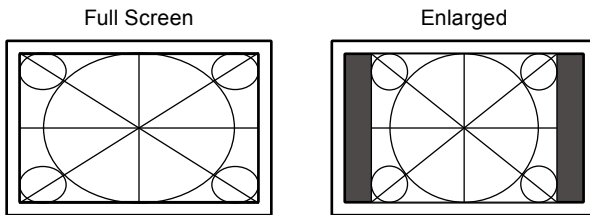

Procedure

1. Choose “Screen” in the Setting menu, and press ENTER.
2. Choose “Screen Size” in the “Screen” menu, and press ENTER.
The “Screen Size” menu appears.
3. Select either “Full Screen” or “Enlarged” with ▼ or ▲.
4. Press ENTER to exit.

Attention

- When a 1280×720 or 1920×1080 resolution image is displayed, the screen size is fixed to “Full Screen”.

● To adjust brightness of non-display area

When the screen size setting is “Enlarged”, a border (black area with no image) around the image appears.

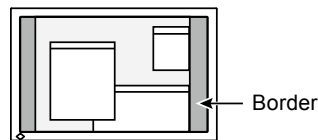

Procedure

1. Choose “Monitor Settings” in the Setting menu, and press ENTER.
2. Choose “Border Intensity” in the “Monitor Settings” menu, and press ENTER.
The “Border Intensity” menu appears.
3. Use ▼ or ▲ for adjustment.
4. Press ENTER to exit.

Chapter 3 Setting Monitor

3-1. Adjusting Volume

This function allows you to adjust the volume.

Adjustable range

0 to 30

Procedure

1. Press ▼/⏮).
2. Use ▼ or ▲ for adjustment.
3. Press ENTER to exit.

Note

- The volume for the speakers and the headphone can be set individually.
-

3-2. Selecting sound source while using the DisplayPort signal input

This function allows you to switch sound source during DisplayPort signal input. You can select the Stereo Mini Jack or DisplayPort.

Procedure

1. Choose “Sound” in the Setting menu, and press ENTER.
2. Choose “Source” in the “Sound” menu, and press ENTER.
The “Source” menu appears.
3. Select “Stereo Mini Jack” or “DisplayPort” with ▼ or ▲.
4. Press ENTER to exit.

Note

- This function is available with DisplayPort signal input.
-

3-3. Enabling / Disabling DDC/CI communication

This function allows you to enable / disable the DDC/CI communication.

Procedure

1. Choose “Monitor Settings” in the Setting menu, and press ENTER.
2. Choose “DDC/CI” in the “Monitor Settings” menu, and press ENTER.
The “DDC/CI” menu appears.
3. Select “On” or “Off” with ▼ or ▲.
4. Press ENTER to exit.

Note

- The DisplayPort input of this monitor does not support DDC/CI communication.
-

3-4. Locking Operation Buttons

This function allows you to lock the settings to prevent them being changed.

Procedure

1. Press **⏻** to turn off the monitor.
2. Hold down **SIGNAL** while pressing **⏻** to turn on the monitor.
The Lock / Unlock setting is toggled by performing the operation in step 2.

Note

- The following operations are available even if the buttons are locked:
 - Turning on or off the monitor with the Power button
-

3-5. Setting Orientation

This function allows you to change the orientation of the Setting menu when using the monitor screen in vertical display position.

Procedure

1. Choose “Monitor Settings” in the Setting menu, and press **ENTER**.
2. Choose “Menu Settings” in the “Monitor Settings” menu, and press **ENTER**.
3. Choose “Orientation” in the “Menu Settings” menu, and press **ENTER**.
The “Orientation” menu appears.
4. Select “Landscape” or “Portrait” with **▼** or **▲**.
5. Press **ENTER** to exit.
6. When selecting “Portrait”, turn the monitor screen 90° in clockwise direction.

Attention

- Be sure that the cables are correctly connected.
 - Be sure to turn the monitor screen after pulling up the screen to the uppermost position of the stand and setting the screen tilted upward.
-

Note

- For using the monitor with “Portrait” position, the graphics board supporting portrait display is required. When placing the monitor in a “Portrait” position, settings of your graphics board need to be changed. Refer to the User’s Manual of the graphics board for details.
-

3-6. Showing and hiding the EIZO logo

When the monitor is turned on, the EIZO logo appears on the screen. You can choose to show or hide the display of the EIZO logo.

Procedure

1. Choose “Monitor Settings” in the Setting menu, and press **ENTER**.
2. Choose “Menu Settings” in the “Monitor Settings” menu, and press **ENTER**.
3. Choose “Logo” in the “Menu Settings” menu, and press **ENTER**.
The “Logo” menu appears.
4. Select “On” or “Off” with **▼** or **▲**.
5. Press **ENTER** to exit.

3-7. Changing Setting Menu Display Position

You can change the display position of the Setting menu.

Procedure

1. Choose “Monitor Settings” in the Setting menu, and press ENTER.
2. Choose “Menu Settings” in the “Monitor Settings” menu, and press ENTER.
3. Choose “Menu Position” in the “Menu Settings” menu, and press ENTER.
The “Menu Position” menu appears.
4. Choose the position with ▼ or ▲.
5. Press ENTER to exit.

3-8. Setting Language

This function allows you to select a language for the Setting menu or messages.

Selectable languages

English, German, French, Spanish, Italian, Swedish, Japanese, Simplified Chinese, Traditional Chinese

Procedure

1. Choose “Monitor Settings” in the Setting menu, and press ENTER.
2. Choose “Language” in the “Monitor Settings” menu, and press ENTER.
The “Language” menu appears.
3. Choose a language with ▼ or ▲.
4. Press ENTER to exit.

3-9. Resetting the Monitor to the Default Settings

The setting values are reset to the default settings.

Attention

- After resetting, you cannot undo the operation.
-

● To reset the color adjustments

This function only resets the color adjustments for the currently selected mode to the default settings.

Procedure

1. Choose “Color” in the Setting menu, and press ENTER.
2. Choose “Color Reset” in the “Color” menu, and press ENTER.
3. Select “Yes” with ▼ or ▲.
4. Press ENTER.

The color adjustments revert to the default settings.

● To reset “EcoView Sense Settings”

This function resets adjustments for “EcoView Sense Settings” to the default settings.

Procedure

1. Press .
2. Choose “EcoView Sense Settings” in the “EcoView Menu”, and press ENTER.
3. Choose “Reset” in the “EcoView Sense Settings”, and press ENTER.
4. Select “Yes” with ▼ or ▲.
5. Press ENTER.

The “EcoView Sense Settings” adjustments revert to the default settings.

Note

- “EcoView Sense Settings” can be changed and reset only when “EcoView Sense” is set to “On” (see “4-4. Setting the power saving mode when a person leaves the monitor” (page 29)).
-

● To reset all adjustments to the default settings

This function resets all adjustments to the default settings.

Procedure

1. Choose “Monitor Settings” in the Setting menu, and press ENTER.
2. Choose “Reset” in the “Monitor Settings” menu, and press ENTER.
3. Select “Yes” with ▼ or ▲.
4. Press ENTER.

All adjustments revert to the default settings.

Chapter 4 Power Saving Functions

4-1. Setting Power Saving

● Monitor

This function allows you to set the monitor into the power saving mode according to the PC status. When the monitor has shifted to the power saving mode, the images on the screen are not displayed.

Attention

- Turning off the main power switch or unplugging the power cord completely shuts off power supply to the monitor.
- When the monitor is in power saving mode, devices connected to the USB downstream port will still work. Therefore, power consumption of the monitor varies with connected devices even in the power saving mode.
- Power consumption varies even when the stereo mini jack cable is connected.

Note

- The monitor changes to the power saving mode about 15 seconds after the signal input ceases to be detected.

Procedure

1. Choose “PowerManager” in the Setting menu, and press ENTER.
2. Choose “Power Save” in the “PowerManager” menu, and press ENTER.
The “Power Save” menu appears.
3. Select “On” or “Off” with ▼ or ▲.
4. Press ENTER to exit.

Power Saving System

Analog Signal Input

This monitor complies with the VESA DPM standard.

PC		Monitor	Power Indicator
On		Operating	White
Power saving mode	STAND-BY SUSPENDED OFF	Power saving mode	Orange
Power Off		Power saving mode	Orange

Digital Signal Input

- DVI
This monitor complies with the DVI DMPM standard.
- DisplayPort
This monitor complies with the DisplayPort Standard V1.1a.

PC		Monitor	Power Indicator
On		Operating	White
Power saving mode		Power saving mode	Orange
Power Off		Power saving mode	Orange

Exiting the power saving mode

If the monitor receives input, it automatically exits the power saving mode and returns to the normal display mode.

● Audio Output

This monitor allows you to turn off the audio output from the speakers / headphone at the power saving mode.

Procedure

1. Choose “Sound” in the Setting menu, and press ENTER.
2. Choose “Power Save” in the “Sound” menu, and press ENTER.
The “Power Save” menu appears.
3. Select “Sound On” or “Sound Off” with ▼ or ▲.
4. Press ENTER to exit.

4-2. Setting Power Indicator

This function allows you to set the power indicator (white) ON / OFF in the monitor ON condition.

Procedure

1. Choose “Monitor Settings” in the Setting menu, and press ENTER.
2. Choose “Power Indicator” in the “Monitor Settings” menu, and press ENTER.
The “Power Indicator” menu appears.
3. Select “On” or “Off” with ▼ or ▲.
4. Press ENTER to exit.

4-3. Enabling / Disabling Automatic Brightness Adjustment

● Auto EcoView

The ambient light sensor on the front side of the monitor detects the environmental brightness to adjust the screen brightness automatically and comfortably by using the Auto EcoView function.

Attention

- Be careful not to block the ambient light sensor on the lower side of the monitor when using the Auto EcoView function.
-

Procedure

1. Press .
2. Choose “Auto EcoView” in the “EcoView Menu” menu, and press ENTER.
The “Auto EcoView” menu appears.
3. Select “High”, “Standard”, or “Off” with ▼ or ▲.
4. Press ENTER to exit.

Note

- As “Brightness” in the Setting menu is changed, the auto adjustment range for Auto EcoView is also changed.
 - Set to “High” if you feel a little brighter with “Standard” setting status.
-

● EcoView Optimizer 2

Using the EcoView Optimizer 2 function automatically adjusts the screen brightness according to the white level of the input signal. This function can reduce the power consumption while maintaining the brightness specified by the input signal.

Procedure

1. Press .
2. Choose “EcoView Optimizer 2” in the “EcoView Menu” menu, and press ENTER.
The “EcoView Optimizer 2” menu appears.
3. Select “On” or “Off” with ▼ or ▲.
4. Press ENTER to exit.

Note

- When “Movie” is selected from the color mode, the setting is turned “Off”.
 - When the EcoView Optimizer 2 function is “On”, the appearance of pale color may change. If that bothers you, set this function to “Off”.
-

4-4. Setting the power saving mode when a person leaves the monitor

The sensor on the front side of the monitor detects the movement of a person by using the EcoView Sense function. When a person moves away from the monitor, it shifts to the power saving mode automatically and does not display the images on the screen to reduce the power consumption. When a person comes near the monitor again, it recovers from the power saving mode and displays the images. The sensitivity and time until the power saving mode is activated can be set according to the monitor usage environment and movement of the user.

Note

- At the time of shifting to power saving mode, the message that indicates shifting is displayed.
-

Procedure

1. Press .

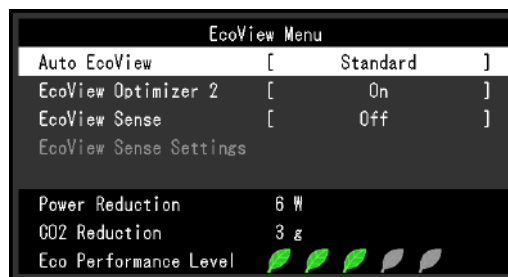

2. Choose “EcoView Sense” in the “EcoView Menu”, and press ENTER.
The “EcoView Sense” menu appears.
3. Select “On” or “Off” with ▼ or ▲.
4. Press ENTER to exit.

5. When “On” is selected, select “EcoView Sense Settings” for setting the details.

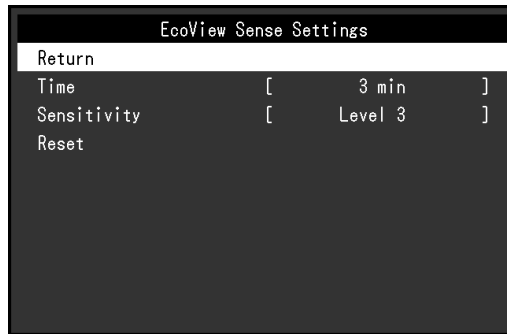

Item	Setting Range	Description
Time	5, 30 sec 1, 3, 5, 10, 15, 30, 45, 60 min	Specifies the time from when a person leaves the monitor until the “No Presence detected” message appears. The monitor shifts to the power saving mode about 20 seconds after the message is displayed.
Sensitivity	Level 5 Level 4 Level 3 Level 2 Level 1	When the setting level is high (“Level 5” at maximum), even minor movements of a person are detected, causing the monitor to shift to the power saving mode only infrequently. On the other hand, when the setting level is low (“Level 1” at minimum), only major movements of a person are detected, allowing the monitor to shift to the power saving mode frequently. EcoView Sense is activated when the sensor on the front side of the monitor detects the movement of heat. Therefore, the sensitivity should be changed depending on the typical user’s clothes or the typical room temperature. If the monitor shifts to or recovers from the power saving mode contrary to your expectations, try changing the setting level.
Reset	-	This function resets all adjustments to the default settings.

Note

- When the monitor is used in the “Portrait” direction, the detection sensitivity is lower than the “Landscape” direction. Try increasing the sensitivity setting value when switching the mode to the power saving mode.
- To use the monitor comfortably, increase the sensitivity for high temperatures, which reduces the detection sensitivity, and reduce the sensitivity for low temperatures, which increases the detection sensitivity.

4-5. Checking the power saving level

The EcoView menu allows you to check Power Reduction, CO₂ Reduction, and Eco Performance Level. The more indicators light up representing the Eco Performance Level, the higher the power saving level attained.

Example:

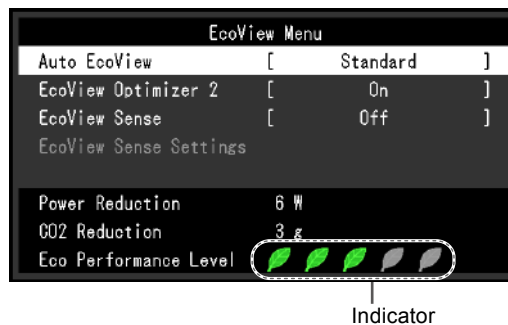

Procedure

1. Press .

The “EcoView Menu” menu appears.

Note

- Power reduction: the backlight’s reduction of power consumption as a result of the adjusted brightness value.
CO₂ reduction: converted from the “Power reduction” value, this is an estimate of the quantity of CO₂ emissions reduced when using the monitor for 1 hour.
* The numeric value is a result of a calculation based on a default setting (0.000555 t -CO₂/kWh) determined by a Japanese ministerial ordinance (2006, Ministry of Economy, Trade and Industry, Ministry of Environment, civil code article 3) and may differ depending on country and year.

4-6. Enabling / Disabling Auto Power-OFF

This function allows you to switch the setting to turn off the monitor automatically after a specified time has passed in the power saving mode.

Adjustable range

Off, 0, 1, 2, 3, 5, 10, 15, 20, 25, 30, 45 min, 1, 2, 3, 4, 5 h





Procedure

1. Choose “PowerManager” in the Setting menu, and press ENTER.
2. Choose “Eco Timer” in the “PowerManager”, and press ENTER.
3. Select “Off” or time to turn off the monitor with ▼ or ▲.
4. Press ENTER to exit.

Chapter 5 Troubleshooting

If a problem still remains after applying the suggested remedies, contact your local EIZO representative.

5-1. No picture



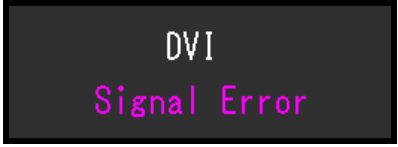









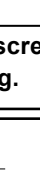

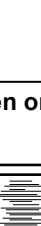
Problem	Possible cause and remedy
<p>1. No picture</p> <ul style="list-style-type: none"> Power indicator does not light. 	<ul style="list-style-type: none"> Check whether the power cord is connected properly. Turn the main power switch on. Press . Turn off the main power, and then turn it on again a few minutes later.
<ul style="list-style-type: none"> Power indicator is lighting white. 	<ul style="list-style-type: none"> Increase "Brightness", "Contrast", or "Gain" in the Setting menu (see "To perform advanced adjustments" (page 14)).
<ul style="list-style-type: none"> Power indicator is lighting orange. 	<ul style="list-style-type: none"> Switch the input signal with SIGNAL. Move the mouse or press any key on the keyboard. Check whether the PC is turned on. When the EcoView Sense function is "On", the monitor may have shifted to the power saving mode. Come near to the monitor. If the screen is not displayed, move the mouse or press any key on the keyboard. Depending on the PC and graphics board, the input signal is not detected and the monitor does not recover from the power saving mode. If the screen is not displayed even after moving the mouse or pressing any key on the keyboard, turn the monitor off and on using its power button. When the screen is displayed, execute the following procedure. The problem may be improved. <ol style="list-style-type: none"> Press  to turn off the monitor. Hold down  while pressing  to turn on the monitor. <p>"x" is displayed on the menu title of "Information" of the Setting menu (see "6-6. Displaying Monitor Information" (page 44)).</p> <ol style="list-style-type: none"> Reboot the PC. <p>To return to the previous setting, perform steps 1 to 3 again.</p> <div data-bbox="884 1462 1310 1738" data-label="Image"> <pre> Information (DVI) x FlexScan EV2430 S/N: 00000001 Usage Time (h) 0 Input Signal 1920x1200 fH: 74.0kHz fV: 60.0 Hz fD: 154.0MHz </pre> </div>
<ul style="list-style-type: none"> Power indicator is flashing orange. 	<ul style="list-style-type: none"> This problem may occur for the DisplayPort input. Connect via the signal cable specified by EIZO, turn off the monitor, and then turn it on again.

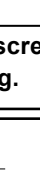
Problem	Possible cause and remedy
<p>2. The message below appears.</p> <ul style="list-style-type: none"> The message shows that the input signal is out of the specified frequency range. Example: 	<p>This message appears when the signal is not input correctly even when the monitor functions properly.</p> <ul style="list-style-type: none"> Check whether the PC is configured to meet the resolution and vertical scan frequency requirements of the monitor (see “2-1. Compatible Resolutions” (page 12)). Reboot the PC. Select an appropriate setting using the graphics board’s utility. Refer to the User’s Manual of the graphics board for details.

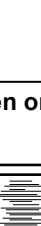
5-2. Imaging problems (for both digital and analog)

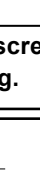
Problem	Possible cause and remedy
<p>1. The screen is too bright or too dark.</p>	<ul style="list-style-type: none"> Use “Brightness” or “Contrast” in the Setting menu to adjust it. (The LCD monitor backlight has a limited life span. When the screen becomes dark or begins to flicker, contact your local EIZO representative.) If the screen is too bright, turn on Auto EcoView. The monitor detects the environmental brightness to adjust the screen brightness automatically.
<p>2. Characters are blurred.</p>	<ul style="list-style-type: none"> Check whether the PC is configured to meet the resolution and vertical scan frequency requirements of the monitor (see “2-1. Compatible Resolutions” (page 12)). When an image is displayed with a resolution other than recommended, the characters or lines of the displayed image may blur. Use “Smoothing” and “Screen Size” in the Setting menu to adjust the display (see “To modify blurred characters / lines” (page 21), and “Screen Size Changing” (page 22)).
<p>3. Afterimages appear.</p>	<ul style="list-style-type: none"> Afterimages are particular to LCD monitors. Avoid displaying the same image for a long time. Use the screen saver or power save function to avoid displaying the same image for extended periods of time.
<p>4. Green/red/blue/white dots or defective dots remain on the screen.</p>	<ul style="list-style-type: none"> This is due to LCD panel characteristics and is not a failure.
<p>5. Interference patterns or pressure marks remain on the screen.</p>	<ul style="list-style-type: none"> Leave the monitor with a white or black screen. The symptom may disappear.
<p>6. Noise appears on the screen.</p>	<ul style="list-style-type: none"> When entering the signals of HDCP system, the normal images may not be displayed immediately.

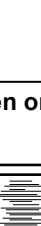
5-3. Imaging problems (for digital only)

Problem	Possible cause and remedy									
<p>1. The monitor configuration is changed to single under the multiple monitor configuration (when DisplayPort is connected).</p>	<ul style="list-style-type: none"> When two monitors are connected to one PC using DisplayPort, and the power to one of the monitors is turned off with the power button, the screen setting may be changed to the single monitor configuration. In such a case, enable the “DP HotPlug” function with the following procedures. Enabling this function may increase the power consumption. <ol style="list-style-type: none"> Press  to turn off the monitor. Hold down  while pressing  to turn on the monitor. Each time the operation enables / disables this function alternatively. <p>The current setting status can be identified based on the color used to display the input port or signal error.</p> <table border="1"> <thead> <tr> <th>Setting</th> <th>Input port</th> <th>Signal Error</th> </tr> </thead> <tbody> <tr> <td>Disable (default setting)</td> <td></td> <td></td> </tr> <tr> <td>Enable</td> <td></td> <td></td> </tr> </tbody> </table> 	Setting	Input port	Signal Error	Disable (default setting)			Enable		
Setting	Input port	Signal Error								
Disable (default setting)										
Enable										

5-4. Imaging problems (for analog only)

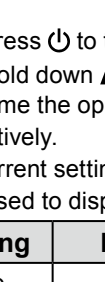
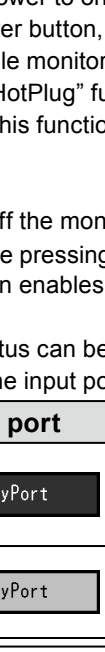
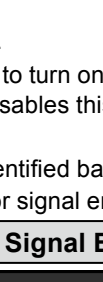
Problem	Possible cause and remedy
<p>1. Display position is incorrect.</p> 	<ul style="list-style-type: none"> Use “Position” in the Setting menu to correct the image position (see “To correct the screen position” (page 21)). If the problem persists, use the graphics board’s utility if available to change the display position.
<p>2. Vertical bars appear on the screen or a part of the image is flickering.</p> 	<ul style="list-style-type: none"> Use “Clock” in the Setting menu to adjust it (see “To eliminate vertical bars” (page 20)).
<p>3. Whole screen is flickering or blurring.</p> 	<ul style="list-style-type: none"> Use “Phase” in the Setting menu to adjust it (see “To remove flickering or blurring” (page 20)).

5-5. Other problems

Problem	Possible cause and remedy
1. The Setting menu does not appear.	<ul style="list-style-type: none"> • Check whether the operation lock function is active (see “3-4. Locking Operation Buttons” (page 24)).
2. The “Smoothing” on the Setting menu “Screen” cannot be selected.	<ul style="list-style-type: none"> • If the resolution is 1920 × 1200, you cannot select smoothing.
3. The auto adjustment function does not work.	<ul style="list-style-type: none"> • This function does not work during digital signal input. • This function operates correctly when images are displayed in the entire viewable area such as in Windows. It does not work properly when an image is displayed only on a part of the screen (command prompt window, for example) or when a black background (wallpaper, etc.) is in use. • This function does not work correctly with some graphics boards.
4. No audio output.	<ul style="list-style-type: none"> • Check whether the stereo mini jack cable is connected properly. • Check whether volume is set to 0. • Check the setting of the PC and the audio playback software. • During DisplayPort signal input, check the “Source” setting (see “3-2. Selecting sound source while using the DisplayPort signal input” (page 23)).
5. (When using EcoView Sense) The images remain to be displayed when you move away from the monitor. / The images do not reappear when you come near it.	<ul style="list-style-type: none"> • Check the setting environment of the monitor. Presence Sensor may not work correctly in the following environments. <ul style="list-style-type: none"> - The monitor is located in a place affected by wind. - There is some heat emitting device near the monitor. - There is some obstacle in front of the sensor. • Check whether any dirt on the sensor. Clean the sensor with a soft cloth. • Check whether you are in front of the monitor. The EcoView Sense function is activated when the sensor on the front side of the monitor detects the movement of heat. • In the high temperature conditions, the monitor may not recover from the power saving mode. If the screen is not displayed even after moving the mouse or pressing any key on the keyboard, turn the monitor off and on using its power button. When the screen is displayed, increase the detection sensitivity value (see “4-4. Setting the power saving mode when a person leaves the monitor” (page 29)).
6. USB devices connected to the monitor do not work.	<ul style="list-style-type: none"> • Check whether the USB cable is connected correctly (see “6-5. Using the USB Hub Function” (page 43)). • Try changing to a different USB port on the PC. • Try changing to a different USB port on the monitor. • Reboot the PC. • If the peripheral devices work correctly when the PC and peripheral devices are connected directly, please contact your local EIZO representative. • Check whether the PC and OS are USB compliant. (For USB compliance of the respective devices, consult their manufacturers.) • Check the PC’s BIOS setting for USB when using Windows. (Refer to the manual of the PC for details.)

Chapter 6 Reference

6-1. Attaching the Optional Arm

An optional arm (or an optional stand) can be attached by removing the stand section. Please refer to our web site for the corresponding optional arm (or optional stand). <http://www.eizo.com>

Attention

- When attaching an arm or stand, follow the instructions of their User's Manual.
- When using another manufacturer's arm or stand, confirm the following in advance and select one conforming to the VESA standard. Use the screws securing the unit and the stand.
 - Clearance between the screw holes: 100 mm × 100 mm
 - Thickness of plate: 2.6 mm
 - Strong enough to support weight of the monitor unit (except the stand) and attachments such as cables.
- When using an arm or stand, attach it to meet the following tilt angles of the monitor.
 - Up 45°, down 45° (horizontal display, and vertical display rotated 90 degrees clockwise)
- Connect the cables after attaching an arm or stand.
- Do not move the removed stand up and down. Doing so may result in injury or device damage.
- The monitor and arm or stand are heavy. Dropping them may result in injury or equipment damage.
- When setting the monitor to the portrait style, turn the monitor screen 90° in clockwise direction.

Procedure

1. Lay the LCD monitor on a soft cloth spread over on a stable surface with the panel surface facing down.

2. Remove the stand.

Prepare a screwdriver. Loosen the screws (four) securing the unit and the stand with the screwdriver.

3. Attach the arm or stand to the monitor.

Secure the monitor to the arm or stand using the screws specified in the User's Manual of the arm or stand.

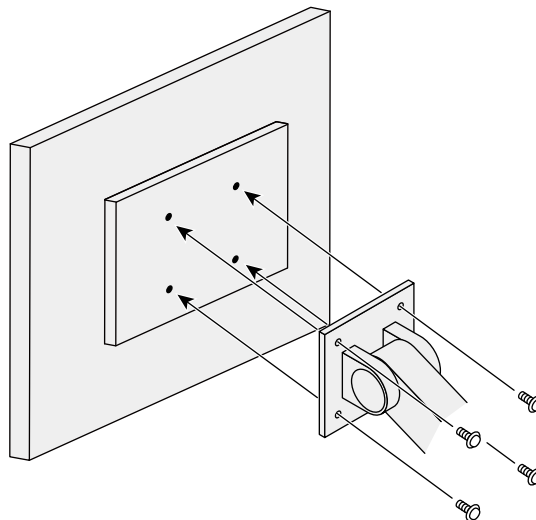

6-2. Detaching/Attaching Stand Base

Detaching procedure

The stand base that was attached during setup can be detached using the following procedures.

1. Lay the LCD monitor on a soft cloth spread over on a stable surface with the panel surface facing down.
2. Turn the fixing screw on the stand base to detach it.

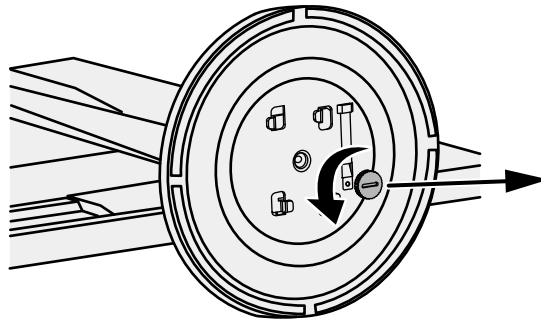

Note

- The fixing screw can be removed by hand. If the fixing screw is too tight, use a coin or flathead screwdriver.
-

3. Turn the stand base in the counterclockwise direction to detach it.

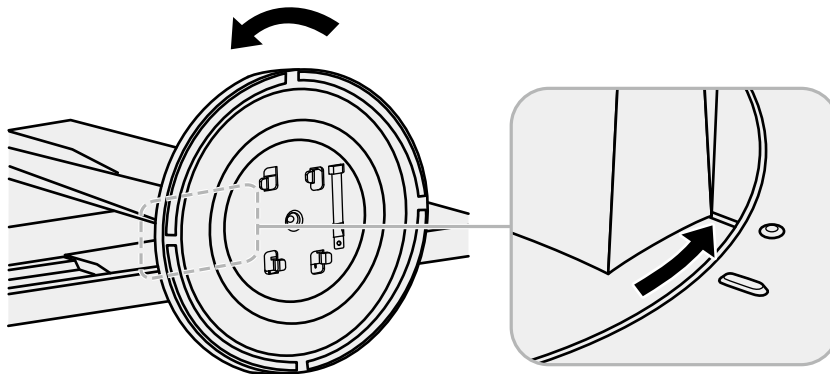

Note

- Reattach the fixing screw onto the stand base for when the stand base is used again.
-

Attaching procedure

The once removed the stand base can be attached to the monitor again with the following procedures.

- 1. Check that the fixing screw is firmly attached to the bottom of the stand base.**
- 2. Place the stand base on a stable surface.**

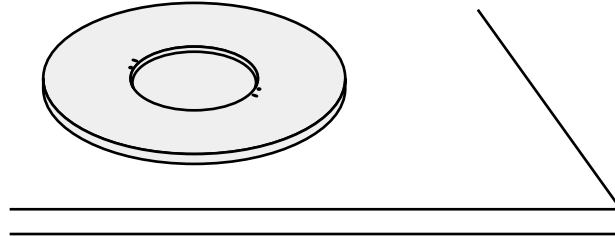

- 3. Insert the stand brace into the stand base.**

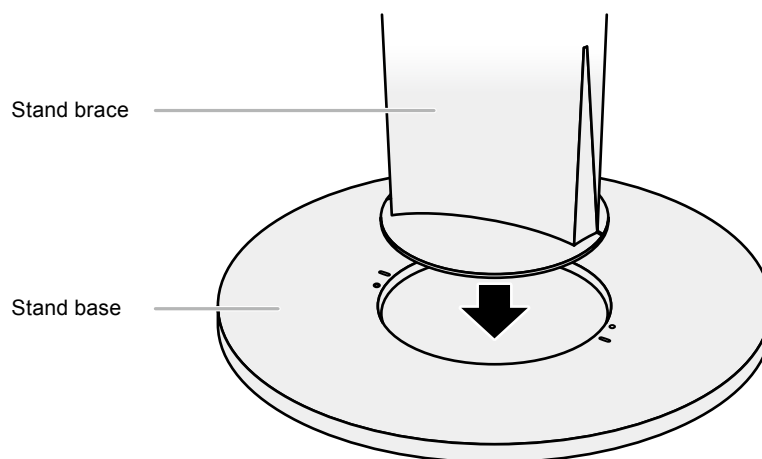
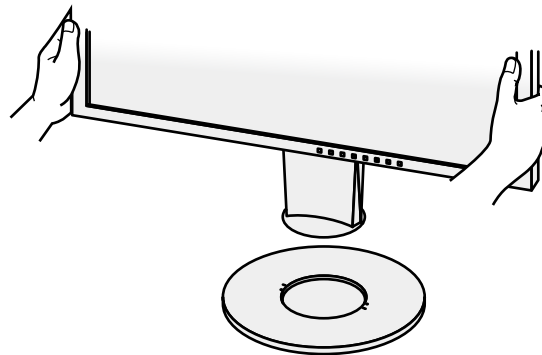

4. Turn the stand brace in the clockwise direction until it clicks.

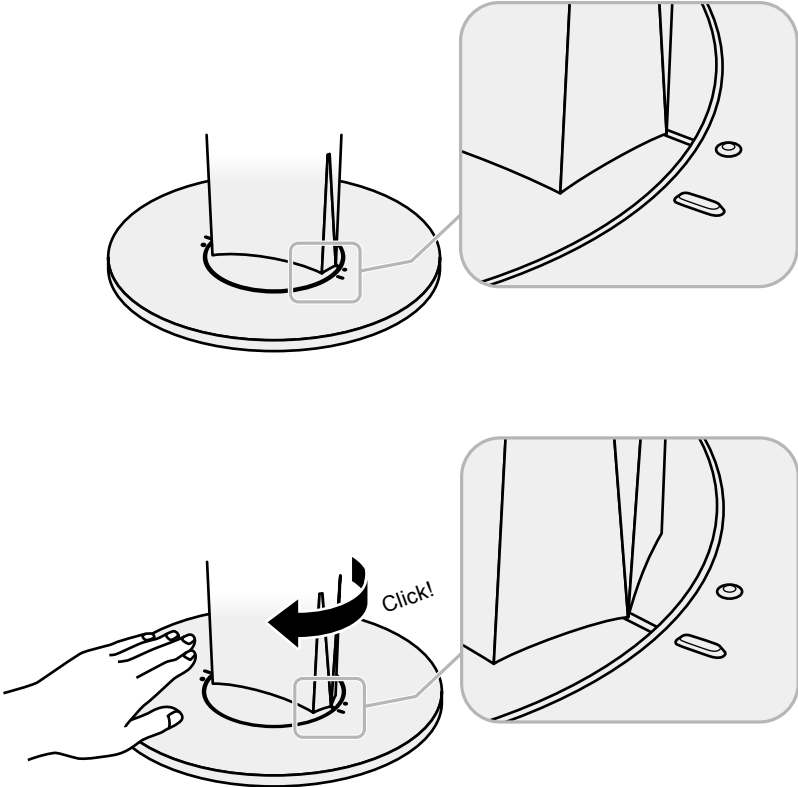

6-3. Attaching/Detaching Cable Holder

A cable holder is supplied with this product. Use the holder to organize the cables connected to the monitor.

Attaching procedure

1. Pass the cables through the cable holder.
2. Close the opening in the cable holder.

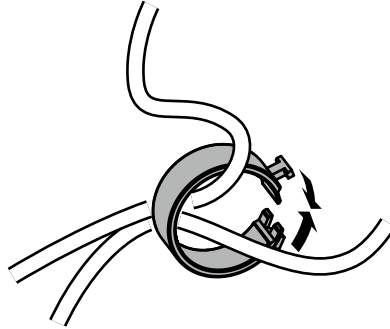

3. While holding the cable holder closed, attach it onto the stand.

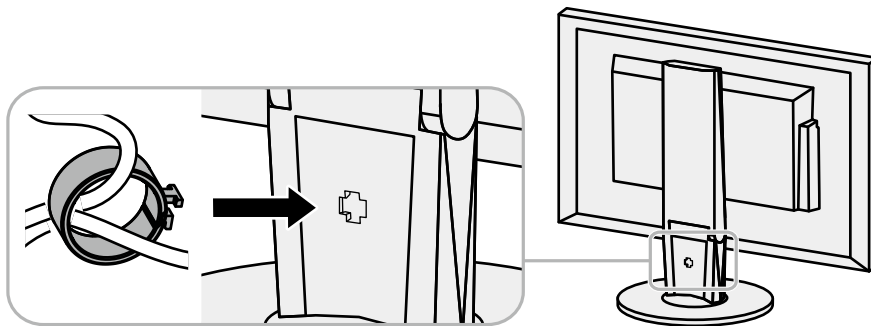

Note

- The cable holder can be inserted either perpendicular or parallel to the stand. Change the direction of the cable holder according to the conditions of the cables.

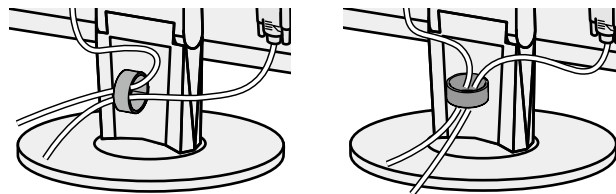

Detaching procedure

- 1.** Close the opening in the cable holder.
- 2.** While holding the cable holder closed, remove it from the stand.

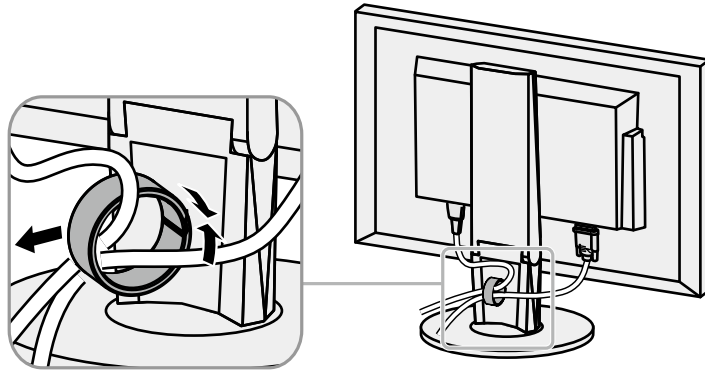

6-4. Connecting Multiple PCs

The product has multiple connections to PCs and allows you to switch to one of the connections for display.

Connection examples

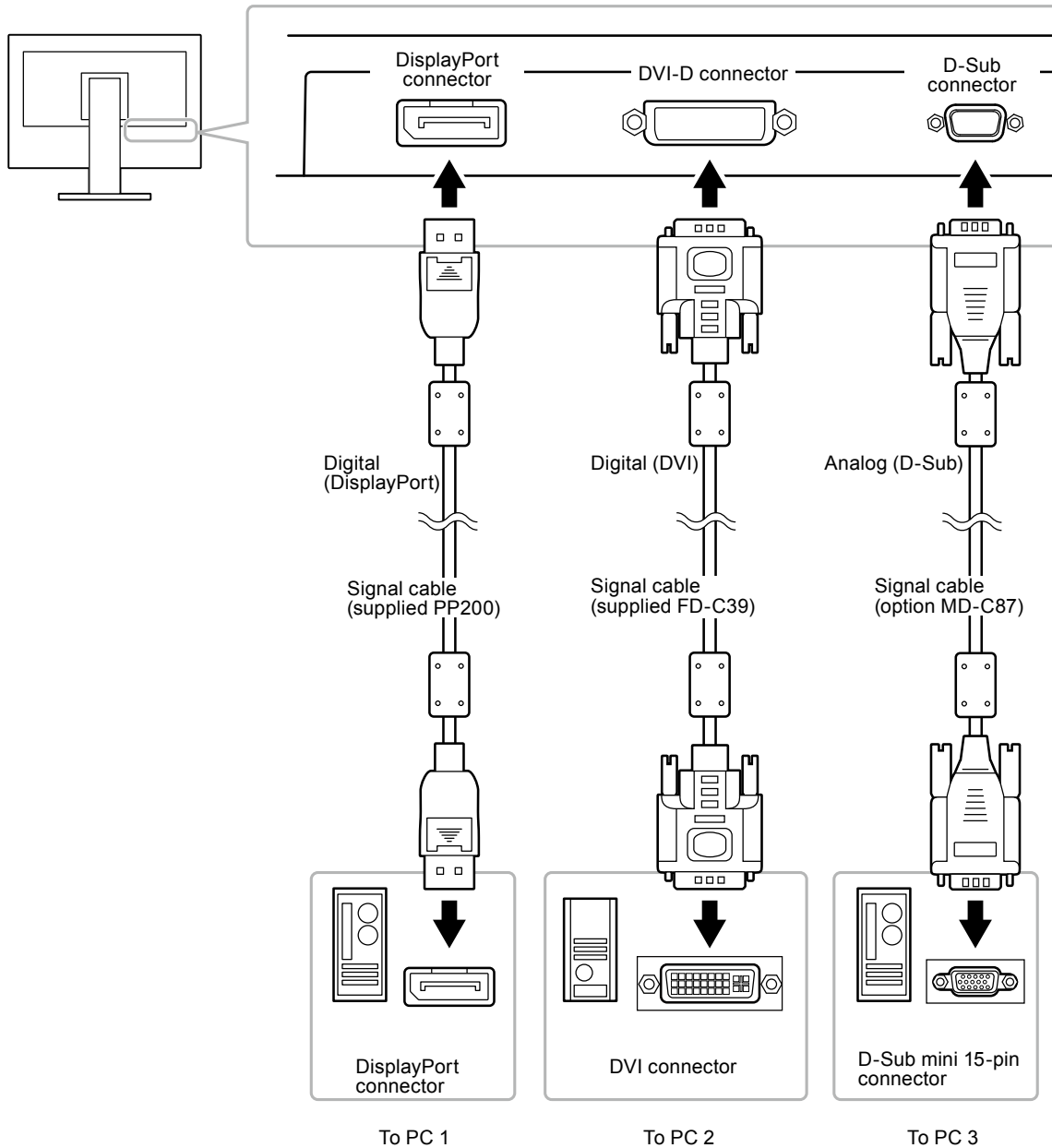

● To switch among input signals

The input signal switches each time SIGNAL is pressed.

When the signal is switched, the active input port name appears at the top right corner of the screen.

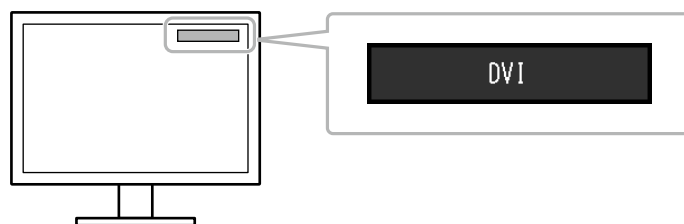

● To set input signal selection

Setting	Function
Auto	The monitor recognizes the connector through which PC signals are input. When a PC is turned off or enters the power saving mode, the monitor automatically displays another signal.
Manual	The monitor displays the signal from the selected connector despite the signal input. Select the input signal for display using the SIGNAL operation button.

Procedure

1. Choose “Monitor Settings” from the Adjustment menu, and press ENTER.
2. Choose “Input Signal” from “Monitor Settings”, and press ENTER.
3. Select “Auto” or “Manual” with ▼ or ▲.
4. Press ENTER to exit.

Note

- If you select “Auto”, the monitor enters the power saving mode after all the PCs have entered the power saving mode or have been switched off.
-

6-5. Using the USB Hub Function

This monitor has a USB hub. It works as a USB hub when connected to a USB-compatible PC, allowing the connection of peripheral USB devices.

Attention

- This monitor may not work depending on PC, OS or peripheral devices to be used. For USB compatibility of peripheral devices, contact their manufacturers.
 - When the monitor is in power saving mode, devices connected to the USB downstream port will still work. Therefore, power consumption of the monitor varies with connected devices even in the power saving mode.
 - When the main power of the monitor is Off, a device connected to the USB downstream port will not operate.
-

● Connection Procedure (Setup of USB Function)

1. Connect the monitor first to a PC using the signal cable, and run the PC.
2. Connect the USB cable between the USB downstream port of the PC and the USB upstream port of the monitor.

The USB hub function is set up automatically upon connection of the USB cable.

3. Connect the peripheral USB devices to the USB downstream port of the monitor.

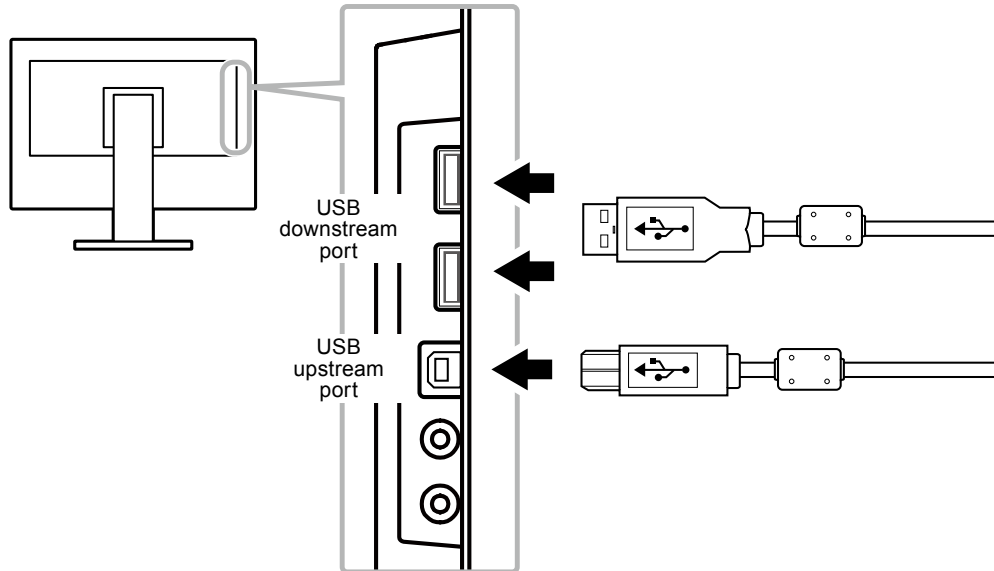

6-6. Displaying Monitor Information

This function allows you to display the model name, serial number, usage time, resolution, and input signal.

Procedure

1. Choose “Information” in the Setting menu, and press ENTER.
The “Information” menu appears.

Attention

- When you turn on the monitor for the first time, the usage time may be more than 0 due to a factory inspection.
-

6-7. Specifications

LCD Panel	Size	24.1-inch (611 mm)	
	Type	TFT color LCD, LED backlight	
	Surface treatment	Anti-Glare Hard Coating	
	Viewing angles	Horizontal 178°, vertical 178° (CR≥10)	
	Dot Pitch	0.270 mm	
	Response Time	Gray-to-gray: 14 ms	
Horizontal Scan Frequency	Analog	31 - 76 kHz	
	Digital	DVI	31 - 76 kHz
		DisplayPort	31 - 76 kHz
Vertical Scan Frequency	Analog	55 - 61 Hz (non-interlace)	
	Digital	DVI	59 - 61 Hz (non-interlace)
		DisplayPort	59 - 61 Hz (non-interlace)
Resolution		1920 Dots × 1200 Lines	
Max. Dot Clock	Analog	202.5 MHz	
	Digital	DVI	162 MHz
		DisplayPort	162 MHz
Max. Display Color		Approx. 16.77 million colors	
Display Area (H × V)		518.4 mm × 324.0 mm	
Power Supply		100 - 240 VAC ±10 %, 50 / 60 Hz 0.65 A - 0.35 A	
Power Consumption	Screen Display On	36 W or less	
	Power saving mode	0.3 W or less (with no USB connections, "EcoView Sense": "Off", and "Sound" - "Power Save": "Sound Off")	
	Power Off	0.3 W or less	
	Main Power Off	0 W	
Input Signal Connector		D-Sub mini 15-pin	
		DVI-D connector (Applicable to HDCP)	
		DisplayPort (Standard V1.1a, applicable to HDCP)	
		Applicable Format (Audio signal) - 2ch linear PCM (32 kHz / 44.1 kHz / 48 kHz / 88.2 kHz / 96 kHz)	
Analog Input Signal (Sync)		Separate, TTL, positive / negative	
Analog Input Signal (Video)		Analog, Positive (0.7 Vp-p / 75 Ω)	
Digital Signal (DVI) Transmission System		TMDS (Single Link)	
Audio Output		Speaker output: 1.0 W + 1.0 W Headphone output: 2 mW + 2 mW (32 Ω)	
Dimensions (Width) × (Height) × (Depth)	Main unit	552.5 mm × 368 - 499 mm × 233 mm	
	Main unit (without stand)	552.5 mm × 358 mm × 56.9 mm	
Mass	Main unit	Approx. 6.7 kg	
	Main unit (without stand)	Approx. 4.3 kg	
Movable range		Tilt:	35° Up, 5° Down
		Swivel:	344°
		Adjustable height:	140 mm (131 mm for tilt of 0°)
		Rotation:	90° (Clockwise)

Environmental Conditions	Temperature	Operating:	5°C to 35°C
		Transportation/ Storage:	-20°C to 60°C
	Humidity	Operating:	20 % to 80 % R.H. (no condensation)
		Transportation/ Storage:	10 % to 90 % R.H. (no condensation)
	Air Pressure	Operating:	540 to 1,060 hPa
		Transportation/ Storage:	200 to 1,060 hPa
USB	Standard	USB Specification Revision 2.0	
	Port	Upstream port × 1, Downstream port × 2	
	Communication Speed	480 Mbps (high), 12 Mbps (full), 1.5 Mbps (low)	
	Supply current	Downstream:	Max. 500mA/1 port

● Accessories

Signal cable	MD-C87 (D-Sub - D-Sub)
Cleaning Kit	EIZO "ScreenCleaner"

For the latest information about the accessories, refer to our web site.

<http://www.eizoglobal.com>

Appendix

Trademark

The terms HDMI and HDMI High-Definition Multimedia Interface, and the HDMI Logo are trademarks or registered trademarks of HDMI Licensing, LLC in the United States and other countries.

The DisplayPort Compliance Logo and VESA are registered trademarks of the Video Electronics Standards Association.

The SuperSpeed USB Trident Logo is a registered trademark of USB Implementers Forum, Inc.



DICOM is the registered trademark of the National Electrical Manufacturers Association for its standards publications relating to digital communications of medical information.

Kensington and Microsaver are registered trademarks of ACCO Brands Corporation.

Thunderbolt is a trademark of Intel Corporation in the United States and/or other countries.

Microsoft and Windows are registered trademarks of Microsoft Corporation in the United States and other countries.

Adobe is a registered trademark of Adobe Systems Incorporated in the United States and other countries.

Apple, macOS, Mac OS, OS X, Macintosh and ColorSync are registered trademarks of Apple Inc.

EIZO, the EIZO Logo, ColorEdge, CuratOR, DuraVision, FlexScan, FORIS, RadiCS, RadiForce, RadiNET, Raptor and ScreenManager are registered trademarks of EIZO Corporation in Japan and other countries.

ColorEdge Tablet Controller, ColorNavigator, EcoView NET, EIZO EasyPIX, EIZO Monitor Configurator, EIZO ScreenSlicer, G-Ignition, i•Sound, Quick Color Match, RadiLight, Re/Vue, Screen Administrator, Screen InStyle and UniColor Pro are trademarks of EIZO Corporation.

All other company and product names are trademarks or registered trademarks of their respective owners.

License

The bitmap font used for this product is designed by Ricoh Industrial Solutions Inc.

ENERGY STAR

As an ENERGY STAR Partner, EIZO Corporation has determined that this product meets the ENERGY STAR guidelines for energy efficiency.



FCC Declaration of Conformity

For U.S.A., Canada Only

FCC Declaration of Conformity

We, the Responsible Party

EIZO Inc.

5710 Warland Drive, Cypress, CA 90630

Phone: (562) 431-5011

declare that the product

Trade name: EIZO

Model: FlexScan EV2430

is in conformity with Part 15 of the FCC Rules. Operation of this product is subject to the following two conditions: (1) this device may not cause harmful interference, and (2) this device must accept any interference received, including interference that may cause undesired operation.

This equipment has been tested and found to comply with the limits for a Class B digital device, pursuant to Part 15 of the FCC Rules. These limits are designed to provide reasonable protection against harmful interference in a residential installation. This equipment generates, uses, and can radiate radio frequency energy and, if not installed and used in accordance with the instructions, may cause harmful interference to radio communications. However, there is no guarantee that interference will not occur in a particular installation. If this equipment does cause harmful interference to radio or television reception, which can be determined by turning the equipment off and on, the user is encouraged to try to correct the interference by one or more of the following measures.

- * Reorient or relocate the receiving antenna.
- * Increase the separation between the equipment and receiver.
- * Connect the equipment into an outlet on a circuit different from that to which the receiver is connected.
- * Consult the dealer or an experienced radio/TV technician for help.

Changes or modifications not expressly approved by the party responsible for compliance could void the user's authority to operate the equipment.

Note

Use the attached specified cable below or EIZO signal cable with this monitor so as to keep interference within the limits of a Class B digital device.

- AC Cord
- Shielded Signal Cable (enclosed)

Canadian Notice

This Class B information technology equipment complies with Canadian ICES-003.

Cet équipement informatique de classe B est conforme à la norme NMB-003 du Canada.

